

1

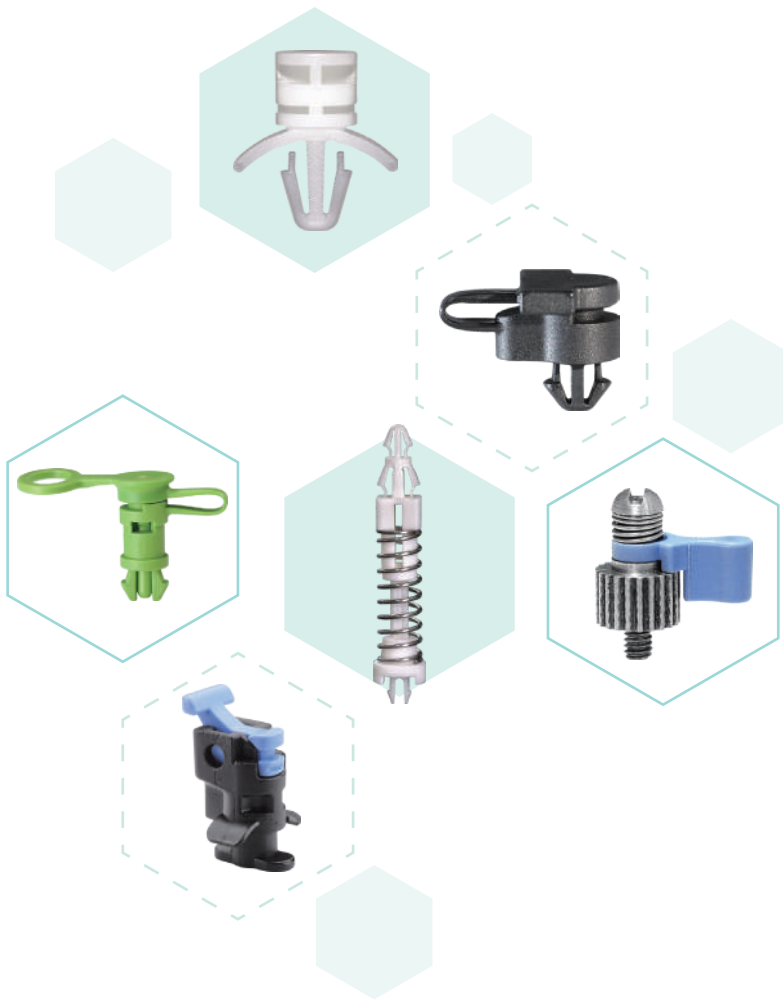

- PC板間隔柱
Spacer Supports
- 導電PC板間隔柱
Conductive
Spacer Supports
- 圓體間隔柱
Round Spacers
- 導光板間隔柱
Pillar Supports
- PC板固定座/扣
PCB Mounting Block &
Hinges
- 銅柱/塑膠銅柱
Standoffs



PC板間隔柱裝配孔快速索引

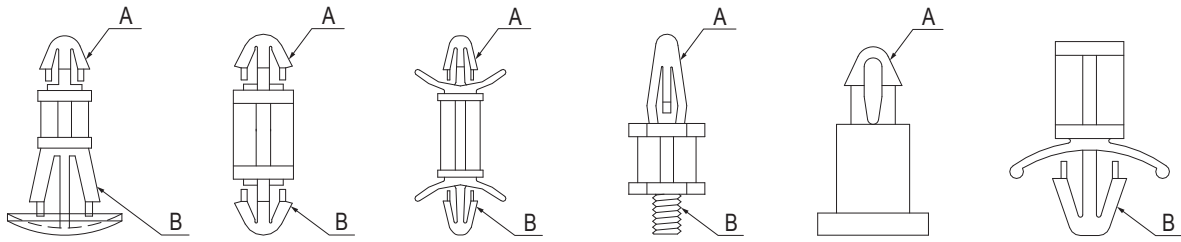

Part No.	A	B	Page	Note
MCIA-		3.2X4.8	1-59	橢圓孔
SOR-3		3.2X6.0	1-74	M2.5 or M2.6 Screw
TCBE-		4.0X5.41	1-60	
KVLMMA-10		5.5X7.1	1-58	
KVLM3-		5.5X7.1	1-59	M3X0.5P
KVLM4-10		5.5X7.1	1-59	M4X0.7P
PAA-11		6.0X7.0	1-68	
LIJ-4		Ø2.5	1-69	
LBS-		Ø3.0	1-46	
MSA-		Ø3.0	1-48	
TCBA-		Ø3.0	1-51	
LIO-		Ø3.0	1-69	
LIO-8		Ø3.0	1-69	
DCCB-4.1		Ø3.0~Ø3.18	1-51	
MSPE-7		Ø3.2	1-29	
LCUA-11		Ø3.4	1-84	
EDC-		Ø3.5	1-2	
LASE-		Ø3.5	1-47	
LASH-22		Ø3.5	1-47	
LASJ-		Ø3.5	1-47	
SSUL-8		Ø3.5	1-75	
LIES-1		Ø3.8	1-75	
RAMA-		Ø4.0	1-1	
RAMC-		Ø4.0	1-2	
LASB-3.7		Ø4.0	1-46	
LASF-18		Ø4.0	1-48	
TCBC-		Ø4.0	1-59	
TCBH-17F		Ø4.0	1-60	
SOR-2		Ø4.0	1-74	
TCEB3-		Ø4.1	1-65	M3X0.5P
TCEB4-		Ø4.1	1-65	M4X0.7P
TCEB632-		Ø4.1	1-65	6-32 UNC
LCU-18		Ø4.3	1-89	
LASD-8.3		Ø4.5	1-46	
RAD-		Ø4.8	1-1	
RAMD-15.5		Ø4.8	1-3	
LCDS3-		Ø4.8	1-45	M3X0.5P
LCDS4-		Ø4.8	1-46	M4X0.7P
LAS-		Ø4.8	1-47	
LASL-4.8		Ø4.8	1-47	
LASY-		Ø4.8	1-47	
ULCF-		Ø4.8	1-76	
WLCF-		Ø4.8	1-76	
ULCBB-		Ø4.8	1-84	
LASA-9.5		Ø4.8~Ø5.0	1-47	
TCBD-4.8		Ø4.8~Ø5.0	1-60	
CUS-5		Ø5.0	1-74	
RAM-		Ø5.5	1-1	
RAM-13.5L		Ø5.5	1-1	
RAML-		Ø5.5	1-1	
RAS-		Ø5.5	1-2	
SOR-1		Ø5.5	1-74	
RAMB-9		Ø5.6	1-3	

Part No.	A	B	Page	Note
LDD-		Ø6.0	1-77	
MCSH-7.2	2.0X3.0		1-55	
KVD-	4.0X5.5	5.0X6.5	1-21	
MASD-	Ø1.5		1-48	
MASS-	Ø1.5		1-48	
MASSD-	Ø1.5	Ø1.5	1-13	
MAEB-3.2	Ø1.5	Ø3.0	1-19	
LCMB-8	Ø1.5	Ø3.0	1-20	
MADSA-3	Ø1.6	Ø1.6	1-13	
MADSB-3	Ø1.6	Ø1.6	1-13	
MADS-	Ø1.6	Ø2.0	1-13	
MAS-9	Ø1.6	Ø2.0	1-13	
MAD1.7-9.8	Ø1.7	Ø1.7	1-13	
MAL-8	Ø2.0		1-48	
MASL-5.4	Ø2.0		1-48	
MAST-	Ø2.0		1-48	
MA-	Ø2.0		1-49	
MAB-4	Ø2.0		1-49	
MABA-2.6	Ø2.0		1-49	
MA-XXDL	Ø2.0		1-49	
MS-	Ø2.0		1-52	
ISS-	Ø2.0		1-77	Double Adhesive Tape
MAD1-	Ø2.0	Ø2.0	1-13	
MAD1.2-12.9	Ø2.0	Ø2.0	1-13	
MAD-	Ø2.0	Ø2.0	1-14	
MAD1.2-	Ø2.0	Ø2.0	1-14	
MADB-	Ø2.0	Ø2.0	1-14	
MADX-9.5	Ø2.0	Ø2.0	1-14	
MADG-5.4	Ø2.0	Ø2.0	1-36	
MAMDA-	Ø2.0	Ø2.5	1-15	
LCMA-	Ø2.0	Ø3.0~Ø3.2	1-40	
RCAB-	Ø2.0	Ø4.0	1-12	
PCLS-25	Ø2.2		1-52	
MAHA-7	Ø2.2	Ø2.2	1-15	
MSB-2.8	Ø2.3		1-52	
ULCBA-5	Ø2.35	Ø4.0	1-82	
ULCSD-5	Ø2.4	Ø2.8	1-82	
SCBS632-	Ø2.5		1-125	6-32 UNC
MAMS-	Ø2.5		1-49	
MAMS-7.5	Ø2.5		1-49	
MAM-	Ø2.5		1-50	
MSM-2.5	Ø2.5		1-52	
MAE2.5-6.5	Ø2.5		1-53	
MAE2.5-6.5T	Ø2.5		1-53	M2X0.4P
GSS-	Ø2.5		1-77	Double Adhesive Tape
ULCI-11	Ø2.5		1-79	
ULCIJ-4	Ø2.5		1-80	
MADA-18S	Ø2.5	Ø2.5	1-15	
MADAA-14	Ø2.5	Ø2.5	1-15	
MADJ-6	Ø2.5	Ø2.5	1-15	
MADA-	Ø2.5	Ø2.5	1-16	
MADM-	Ø2.5	Ø2.5	1-16	
MAMDF-7	Ø2.5	Ø2.5	1-16	

PC板間隔柱裝配孔快速索引

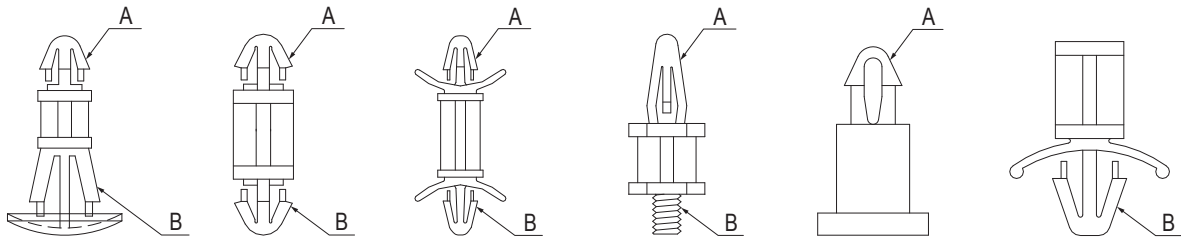

Part No.	A	B	Page	Note
MAMD-9	Ø2.5	Ø2.5	1-16	
MAC-	Ø2.5	Ø2.5	1-17	
MADE-2.8	Ø2.5	Ø2.5	1-17	
MAHC-14.3	Ø2.5	Ø2.5	1-17	
MADMK-5	Ø2.5	Ø2.5	1-20	
LCMC-7	Ø2.5	Ø3.0	1-20	
LCAB-	Ø2.5	Ø3.0	1-40	
LCMD-	Ø2.5	Ø3.0~Ø3.2	1-40	
RCAC-	Ø2.5	Ø4.0	1-12	
MAEE-4.5	Ø2.5	Ø4.0	1-19	
MAM-6.35L	Ø2.6		1-50	
MADAB-4.3	Ø2.6	Ø2.5	1-17	
MADM1-2.2	Ø2.6	Ø2.6	1-17	
MAHC-XXS	Ø2.6	Ø2.6	1-17	
MSPA-1.6	Ø2.6	Ø2.8	1-31	
LCUE-3.3	Ø2.6	Ø3.2	1-83	
MAMA-3.5	Ø2.7		1-50	
LCUAE-16LA	Ø2.8	3.2X4.8	1-87	
MSPA-6.3L	Ø2.8	Ø2.8	1-31	
SCBA-	Ø3.0		1-125	M3X0.5P
SCBD-8	Ø3.0		1-125	M3X0.5P
MSPA3-9.7	Ø3.0		1-126	M3X0.5P
DCC-	Ø3.0		1-50	
DCC-20S	Ø3.0		1-50	
MAL-34	Ø3.0		1-50	
DCE-4	Ø3.0		1-51	
MAE-	Ø3.0		1-53	
MAE-XXT	Ø3.0		1-53	M3X0.5P
MAE-7-440	Ø3.0		1-54	
MAE-7-440T	Ø3.0		1-54	4-40 UNC
DCB-	Ø3.0		1-56	
DCBA-3.5	Ø3.0		1-56	
SS1-	Ø3.0		1-72	M2 Screw
SS3-7(1.3)	Ø3.0		1-72	M2 Screw
BSS-	Ø3.0		1-78	Double Adhesive Tape
CSS-	Ø3.0		1-78	Double Adhesive Tape
CSSA-2	Ø3.0		1-78	Double Adhesive Tape
LCUAC-7	Ø3.0	3.2X4.8	1-86	
LCUAE-12	Ø3.0	3.2X4.8	1-87	橢圓孔
MADL-27.8	Ø3.0	Ø3.0	1-18	
MAMDC-12	Ø3.0	Ø3.0	1-18	
MSPC3-	Ø3.0	Ø3.0	1-21	
MSPC3-3.2L	Ø3.0	Ø3.0	1-21	
MSPF3-	Ø3.0	Ø3.0	1-21	
SSDU1-3.5	Ø3.0	Ø3.0	1-28	
LCJ-	Ø3.0	Ø3.0	1-29	
LCV-	Ø3.0	Ø3.0	1-29	
LCVA-	Ø3.0	Ø3.0	1-29	
LCVU-	Ø3.0	Ø3.0	1-29	
LMSA-6	Ø3.0	Ø3.0	1-32	
CBSA-13	Ø3.0	Ø3.0	1-33	
LCGA-	Ø3.0	Ø3.0	1-33	
LCF-	Ø3.0	Ø3.0	1-34	

Part No.	A	B	Page	Note
LCA-	Ø3.0	Ø3.0	1-37	
LCG-	Ø3.0	Ø3.0	1-41	
LCFO-	Ø3.0	Ø3.5	1-34	
RCI-2.6	Ø3.0	Ø4.0	1-3	
RCO-	Ø3.0	Ø4.0	1-3	
RCA-	Ø3.0	Ø4.0	1-4	
MAEA-3.5	Ø3.0	Ø4.0	1-20	
LCX-31	Ø3.0	Ø4.0	1-30	
LCH-	Ø3.0	Ø4.0	1-37	
RCC-	Ø3.0	Ø4.8	1-4	
LCBT-	Ø3.0	Ø4.8	1-41	
KLCBS-	Ø3.0	Ø4.8	1-42	
LCBUA-13.9	Ø3.0	Ø4.8~Ø5.0	1-41	
RCG-	Ø3.0	Ø5.5	1-5	
DCBA-8	Ø3.1		1-56	
LCUAC-11	Ø3.1	3.2X4.8	1-86	橢圓孔
LCUAE-8	Ø3.1	3.2X4.8	1-86	橢圓孔
MADD-2	Ø3.1	Ø3.0	1-18	
SCB3-	Ø3.2		1-126	M3X0.5P
JSS-	Ø3.2		1-79	Double Adhesive Tape
ULCSE-	Ø3.2	3.2X4.8	1-83	橢圓孔
LCUAC-	Ø3.2	3.2X4.8	1-85	橢圓孔
LCUAC-	Ø3.2	3.2X4.8	1-86	橢圓孔
LCPL-6.4	Ø3.2	Ø2.0	1-32	
LCSE-	Ø3.2	Ø3.0~Ø3.2	1-43	
MADN-24	Ø3.2	Ø3.2	1-18	
MSPB3.2-6.4	Ø3.2	Ø3.2	1-22	
MSPP-	Ø3.2	Ø3.2	1-22	
DMSB-	Ø3.2	Ø3.2	1-24	
DMSS-	Ø3.2	Ø3.2	1-24	
MSP3-	Ø3.2	Ø3.2	1-24	
MSPS3S-7.5	Ø3.2	Ø3.2	1-24	
MSPL-11	Ø3.2	Ø3.2	1-25	
MSPMA-12	Ø3.2	Ø3.2	1-25	
MSPS3-	Ø3.2	Ø3.2	1-25	
LCJ-15	Ø3.2	Ø3.2	1-29	
LMSB-4	Ø3.2	Ø3.2	1-32	
LMSE-4.8	Ø3.2	Ø3.2	1-32	
LMSP-	Ø3.2	Ø3.2	1-32	
RCMB-2.8	Ø3.2	Ø4.0	1-5	
LCUAD-1	Ø3.2	Ø4.1	1-84	
ULCSF-	Ø3.2	Ø4.2	1-82	
RCBS-	Ø3.2	Ø4.8	1-8	
RCR-3.2	Ø3.2	Ø4.8	1-8	
RCV-11.1	Ø3.2	Ø4.8	1-8	
RCW-	Ø3.2	Ø4.8	1-8	
ULCD-7.8	Ø3.3		1-80	M3X0.5P
MSPD-	Ø3.3	3.2X4.8	1-26	橢圓孔
MSPN-	Ø3.3	3.2X4.8	1-26	橢圓孔
MSPQ-16	Ø3.3	3.2X4.8	1-26	橢圓孔
LMSD-	Ø3.3	3.2X4.8	1-45	橢圓孔
ULCH-2	Ø3.3	3.2X4.8	1-80	M2.5 Screw
ULCSA-	Ø3.3	3.2X4.8	1-81	

PC板間隔柱裝配孔快速索引

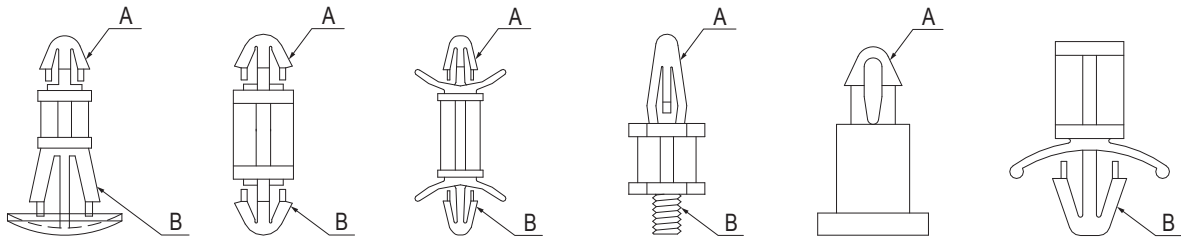

Part No.	A	B	Page	Note
ULCSA-28.8S	Ø3.3	3.2X4.8	1-82	
KEMS-11.3	Ø3.3	5.5X5.5	1-88	
MSPB-	Ø3.3	Ø3.2	1-22	
MSPH-7.5	Ø3.3	Ø3.2	1-26	
MSPF3.3-8L	Ø3.3	Ø3.3	1-22	
MSPCA-16	Ø3.3	Ø3.3	1-23	
MSPCA3.3-	Ø3.3	Ø3.3	1-23	
MSPF3.3-	Ø3.3	Ø3.3	1-23	
DMSC-4.5	Ø3.3	Ø3.3	1-25	
LCOA-28.8	Ø3.3	Ø3.3	1-33	
SCB3-38	Ø3.4		1-126	M3X0.5P
LCIA-3.5	Ø3.4	Ø3.7	1-30	
RCCA-8	Ø3.4	Ø4.8	1-5	
ULCBA-7.8	Ø3.4	Ø4.8	1-83	
SCBB-3	Ø3.5		1-125	M3X0.5P
SCBC-	Ø3.5		1-125	M3X0.5P
MCM-	Ø3.5		1-51	
PDC-	Ø3.5		1-56	
MCN-10	Ø3.5		1-57	
PDC-	Ø3.5		1-57	
PDC-XXD	Ø3.5		1-57	
FSL-25	Ø3.5		1-78	Double Adhesive Tape
FSS-	Ø3.5		1-78	Double Adhesive Tape
FSSA-15	Ø3.5		1-78	
LCPLB-11	Ø3.5	Ø2.6	1-32	
MAD3.5-12	Ø3.5	Ø3.5	1-19	
MAF-	Ø3.5	Ø3.5	1-19	
MAFA-6	Ø3.5	Ø3.5	1-19	
MDLS-4.5	Ø3.5	Ø3.5	1-19	
MAMDD-6	Ø3.5	Ø3.5	1-20	
LCI-	Ø3.5	Ø3.5	1-30	
LDE-33	Ø3.5	Ø3.5	1-30	
CBCS-14	Ø3.5	Ø3.5	1-34	
LCD-	Ø3.5	Ø3.5	1-34	
LCO-	Ø3.5	Ø3.5	1-35	
CBSS-	Ø3.5	Ø3.5	1-37	
LCPA-8.2	Ø3.5	Ø4.0	1-44	
LCBU-	Ø3.5	Ø4.8	1-41	
KLCBM-	Ø3.5	Ø4.8	1-42	
RCT-	Ø3.5	Ø4.8~Ø5.0	1-10	
RCH-	Ø3.5	Ø5.5	1-5	
RCTA-4.5	Ø3.5	Ø5.5	1-10	
DCCA-4.3	Ø3.7		1-51	
UCBS-5A	Ø3.8	Ø4.8	1-44	
MSMA-3.5	Ø3.9		1-52	
MSP-15.9S	Ø3.9	Ø3.9	1-27	
MSPV-3	Ø3.9	Ø3.9	1-27	
MSPY-12.7	Ø3.96	Ø3.96	1-27	
MSPG3-	Ø3.9~Ø4.0		1-126	M3X0.5P
MSPG4-	Ø3.9~Ø4.0		1-126	M4X0.7P
MSPS-	Ø3.9~Ø4.0		1-126	6-32 UNC
MSPS-	Ø4.0		1-126	6-32 UNC
SCB-	Ø4.0		1-127	6-32 UNC

Part No.	A	B	Page	Note
SCB4-	Ø4.0		1-127	M4X0.7P
SCB-6SM3	Ø4.0		1-127	M3X0.5P
SCB832-	Ø4.0		1-127	8-32 UNC
MCO-16	Ø4.0		1-51	
MAE43-	Ø4.0		1-54	M3X0.5P
MAE43-4.8LT	Ø4.0		1-54	
MAE43-XXT	Ø4.0		1-54	M3X0.5P
MAE4D-6	Ø4.0		1-54	
MAE4D-6T	Ø4.0		1-54	M3X0.5P
MAE4-	Ø4.0		1-55	
MAE4-XXT	Ø4.0		1-55	M4X0.7P
MCI-4.7	Ø4.0		1-55	
MC-	Ø4.0		1-57	
MC-	Ø4.0		1-58	
MCE-1.9	Ø4.0		1-58	
MCEA-1.9	Ø4.0		1-58	
MCH-	Ø4.0		1-58	
TCBS-	Ø4.0		1-62	M3 Screw
TCBS-18	Ø4.0		1-62	M3 Screw
TCBT-	Ø4.0		1-62	M3 Screw
TCBT-16	Ø4.0		1-62	4-40 UNC
TCBT-3.6	Ø4.0		1-62	
TCBT-7	Ø4.0		1-62	4-40 UNC
BS-	Ø4.0		1-63	
BS-10-1	Ø4.0		1-63	M3.5~M4 Screw
BS-20-1	Ø4.0		1-63	M3.5~M4 Screw
BS-35.7	Ø4.0		1-63	M3.5 Screw
MBS-	Ø4.0		1-63	
BSB-6	Ø4.0		1-64	
BSCL-9.5	Ø4.0		1-64	
SRLCB-	Ø4.0		1-64	
BSB632-15.9	Ø4.0		1-66	6-32 UNC
BSC632-	Ø4.0		1-66	6-32 UNC
BSCB-	Ø4.0		1-66	M3X0.5P
BSCB-20	Ø4.0		1-66	M3X0.5P
BSCB4-	Ø4.0		1-66	M4X0.7P
BSCM4-	Ø4.0		1-67	M4X0.7P
BSD632-	Ø4.0		1-67	6-32 UNC
BSDM4-	Ø4.0		1-67	M4X0.7P
SS2-	Ø4.0		1-72	M2.6 Screw
SS2-2.5U	Ø4.0		1-72	M2 Screw
ASS-	Ø4.0		1-79	Double Adhesive Tape
ULCBM4-9.5	Ø4.0		1-81	M4X0.7P
ULCC-	Ø4.0		1-81	M3 Screw
LCBL-8	Ø4.0		1-89	
LCBA-	Ø4.0	2.7X7.2	1-42	
ULCH-1	Ø4.0	4.0X6.8	1-80	
LCSI-10	Ø4.0	5.5X5.5	1-45	
KEML-	Ø4.0	5.5X5.5	1-88	
PCC-11	Ø4.0	6.0X7.0	1-68	
PCC-6	Ø4.0	6.0X7.0	1-68	
RCFA-7	Ø4.0	6.3X6.3	1-10	
KES-15	Ø4.0	6.5X7.0	1-84	

PC板間隔柱裝配孔快速索引

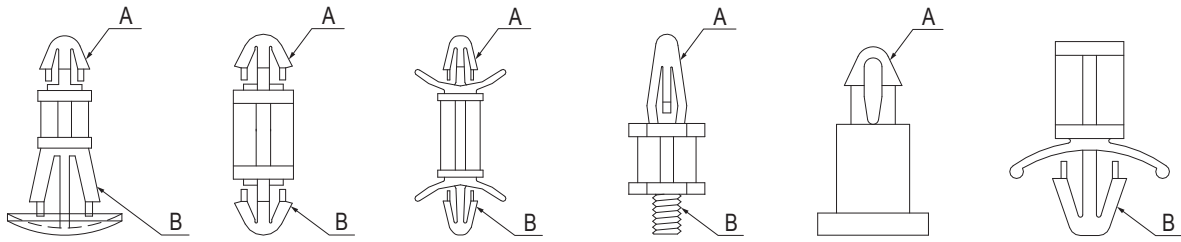

Part No.	A	B	Page	Note
D MSP-	Ø4.0	Ø4.0	1-27	
D MSPS-	Ø4.0	Ø4.0	1-27	
MSP-	Ø4.0	Ø4.0	1-27	
SP1-4.8	Ø4.0	Ø4.0	1-27	
DMSA-9	Ø4.0	Ø4.0	1-28	
MSP1-	Ø4.0	Ø4.0	1-28	
MSPM-	Ø4.0	Ø4.0	1-28	
SSDUA-16.5	Ø4.0	Ø4.0	1-28	
LCK-1	Ø4.0	Ø4.0	1-30	
LCC-	Ø4.0	Ø4.0	1-31	
LCSF-15	Ø4.0	Ø4.0	1-33	
LCBJ-9	Ø4.0	Ø4.0	1-35	
LCFB-8	Ø4.0	Ø4.0	1-35	
LCTA-	Ø4.0	Ø4.0	1-35	
LCEO-	Ø4.0	Ø4.0	1-36	
CBLSS-	Ø4.0	Ø4.0	1-37	
CBSB-45	Ø4.0	Ø4.0	1-38	
LCL-3.2	Ø4.0	Ø4.0	1-38	
LCGB-17.5	Ø4.0	Ø4.0	1-41	
LCSJ-16	Ø4.0	Ø4.0	1-43	
WBHB-1.8	Ø4.0	Ø4.0	1-68	
ULCE-9	Ø4.0	Ø4.0	1-83	
MSPR-3	Ø4.0	Ø4.0	1-91	
LCT-9	Ø4.0	Ø4.5	1-36	
DRCB-18	Ø4.0	Ø4.5~Ø5.0	1-11	
LCSH-9.5	Ø4.0	Ø4.7	1-43	
LCSA-	Ø4.0	Ø4.75	1-43	
RCD-	Ø4.0	Ø4.8	1-6	
MSPK45-	Ø4.0	Ø4.8	1-28	
LCBM-	Ø4.0	Ø4.8	1-31	
LCBD-12.7	Ø4.0	Ø4.8	1-36	
LCBZ-	Ø4.0	Ø4.8	1-36	
CBS-	Ø4.0	Ø4.8	1-38	
LCB-	Ø4.0	Ø4.8	1-38	
LCBSA-	Ø4.0	Ø4.8	1-38	
LCBB-	Ø4.0	Ø4.8	1-39	
LCBS-	Ø4.0	Ø4.8	1-39	
VCBS-	Ø4.0	Ø4.8	1-39	
VCBSL-	Ø4.0	Ø4.8	1-39	
VCBA-14.4F	Ø4.0	Ø4.8	1-40	
KLCBL-	Ø4.0	Ø4.8	1-42	
LCBC-8	Ø4.0	Ø4.8	1-42	
HLCS-	Ø4.0	Ø4.8	1-43	
LCS-	Ø4.0	Ø4.8	1-43	
LCSD-	Ø4.0	Ø4.8	1-44	
LCSL-4.8	Ø4.0	Ø4.8	1-44	
LCSLR-9.5	Ø4.0	Ø4.8	1-44	
LCP-	Ø4.0	Ø4.8	1-44	
LCPD-	Ø4.0	Ø4.8	1-44	
LCY-4.8	Ø4.0	Ø4.8	1-44	
UCBS-	Ø4.0	Ø4.8	1-44	
ULCB-	Ø4.0	Ø4.8	1-85	
RCS-	Ø4.0	Ø5.0	1-6	

Part No.	A	B	Page	Note
RCWA-	Ø4.0	Ø5.4	1-8	
PCBS-6.4	Ø4.0	Ø5.4	1-9	
RCJ-	Ø4.0	Ø5.4	1-11	
RCTL-	Ø4.0	Ø5.4	1-11	
UCBSL-	Ø4.0	Ø5.4	1-45	
RCMA-3	Ø4.0	Ø5.5	1-5	
RCB-	Ø4.0	Ø5.5	1-6	
RCB-11.5	Ø4.0	Ø5.5	1-6	
RCBL-6	Ø4.0	Ø5.5	1-6	
RCI-5	Ø4.0	Ø5.5	1-6	
RCM-	Ø4.0	Ø5.5	1-7	
RCMD-6	Ø4.0	Ø5.5	1-7	
PCBS-	Ø4.0	Ø5.5	1-9	
PCBS-3	Ø4.0	Ø5.5	1-9	
PCBT-	Ø4.0	Ø5.5	1-9	
RCR-12.7	Ø4.0	Ø5.5	1-9	
RBS-	Ø4.0	Ø5.5	1-11	
RBT-	Ø4.0	Ø5.5	1-11	
RCF-	Ø4.0	Ø6.0	1-7	
PCBTA-4.8	Ø4.0	Ø6.0	1-9	
RCFL-	Ø4.0	Ø6.0	1-10	
ACBW-6.8	Ø4.0	Ø6.0	1-67	
ACBR-6	Ø4.0	Ø6.1~Ø6.4	1-60	
RCRA-9.5	Ø4.0	Ø6.35	1-9	
RCFB-10	Ø4.0	Ø6.5	1-10	
ACB-	Ø4.0	Ø6.5	1-61	
MCB-6	Ø4.0	Ø6.5	1-61	
RCQC-7	Ø4.0	Ø7.0	1-24	
WBHC-6.4	Ø4.0	Ø7.9	1-67	
WBH-	Ø4.0	Ø7.9	1-68	
SRLA-	Ø4.1	Ø4.75~Ø4.8	1-65	
BSB-8.5	Ø4.2		1-64	
TCBT-19	Ø4.5		1-62	M3 Screw
MTD-11	Ø4.5		1-63	
MBC-11	Ø4.5	Ø6.5	1-61	
MBD-10	Ø4.5~Ø4.8	Ø16.5	1-61	
MCL-	Ø4.8		1-58	
SS-	Ø4.8		1-73	M3 Screw
SSA-12.7	Ø4.8		1-73	
MSPK4.8-	Ø4.8	Ø4.8	1-28	
LCBY-	Ø4.8	Ø4.8	1-36	
LCBYR-4.8	Ø4.8	Ø4.8	1-36	
MAFB5-	Ø5.0	Ø5.0	1-19	
SSDU-	Ø5.2	Ø5.2	1-29	
RCWB-21	Ø5.3	Ø9.0	1-8	
SSA4-5.5	Ø5.8		1-73	M3.5 or M4 Screw
SS3.5-	Ø5.9		1-73	M3.5 Screw
SS4-	Ø5.9		1-73	M3.5 or M4 Screw
SSU4-	Ø5.9		1-73	M4 Screw
SSUA4-6.3L	Ø6.0		1-73	M4 Screw
RCBC-12	Ø6.2	Ø9.0	1-8	

PC板間隔柱 SPACER SUPPORT

用途：一端固定於機板上，另一端支撐PC板，避免下陷造成短路，PC板免鑽孔。

- Material: Nylon 66 (UL)
- Flame Class: 94V-2/94V-0
- Color: Natural/Black
- Unit: mm

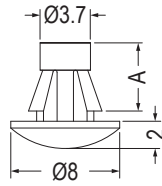
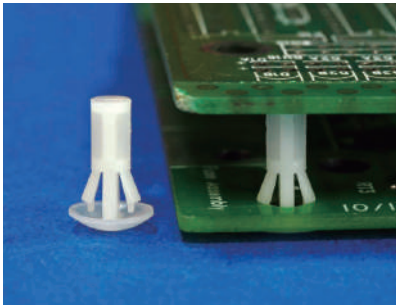

MOUNTING HOLE $\varnothing 4.0$
THICKNESS 0.8~1.6

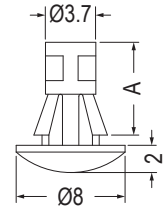

MOUNTING HOLE $\varnothing 4.0$
THICKNESS 0.8~1.6

Part No.	A	Package
RAMA-3	3.2	1000
RAMA-4.5	4.5	
RAMA-5.5	5.5	

Part No.	A	Package
RAMA-6.4	6.4	1000
RAMA-7	7.0	
RAMA-7.5	7.5	
RAMA-9.5	9.5	
RAMA-11.1	11.1	
RAMA-12.7	12.7	

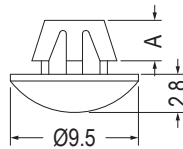
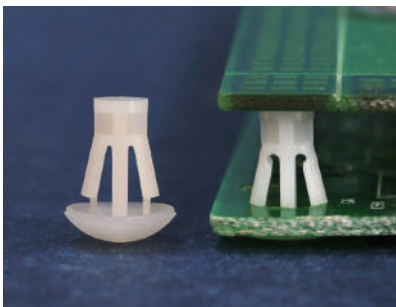

MOUNTING HOLE $\varnothing 4.8$
THICKNESS 0.8~1.2

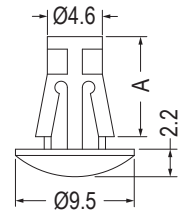

MOUNTING HOLE $\varnothing 4.8$
THICKNESS 0.8~1.2

Part No.	A	Package
RAD-3	3.0	1000
RAD-4	4.0	

Part No.	A	Package
RAD-6	6.3	1000
RAD-8	8.0	
RAD-10	10.0	
RAD-11	11.0	

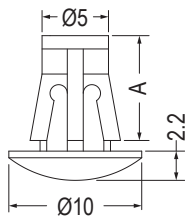

MOUNTING HOLE $\varnothing 5.5$
THICKNESS 0.8~1.6

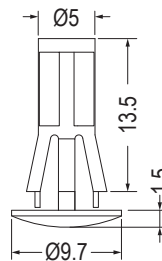

MOUNTING HOLE $\varnothing 5.5$
THICKNESS 1.2~1.8

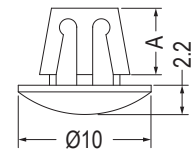

MOUNTING HOLE $\varnothing 5.5$
THICKNESS 0.8~1.6

Part No.	A	Package
RAM-6	6.35	1000
RAM-7	7.0	
RAM-8	8.0	
RAM-8.5	8.5	
RAM-10	10.0	
RAM-12A	12.0	
RAM-12	12.7	
RAM-13.5	13.5	
RAM-14	14.0	
RAM-15	15.2	
RAM-16	15.9	
RAM-18	18.0	
RAM-19	19.0	500
RAM-20	20.0	
RAM-22	21.7	
RAM-24	24.0	
RAM-25	25.4	
RAM-30	30.0	

Part No.	Package
RAM-13.5L	1000

Part No.	A	Package
RAM-3	3.5	1000
RAM-5	5.0	

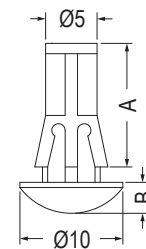

MOUNTING HOLE $\varnothing 5.5$
THICKNESS 1.6~2.5

Part No.	A	B	Package
RAML-11	11.0	3.0	1000
RAML-12	12.0	2.45	

PC板間隔柱 SPACER SUPPORT

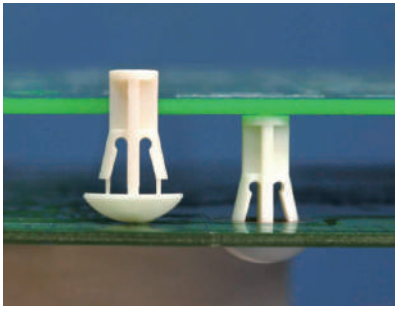

- Material: Nylon 66 (UL)
- Flame Class: 94V-2/94V-0
- Color: Natural/Black
- Unit: mm

用途：一端固定於機板上，另一端支撐PC板，避免下陷造成短路，PC板免鑽孔。

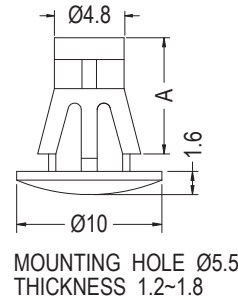

Part No.	A	Package
RAS-6	6.0	1000
RAS-8	8.0	
RAS-10	10.0	
RAS-12	12.0	
RAS-14	14.0	
RAS-18	18.0	
RAS-20	20.0	

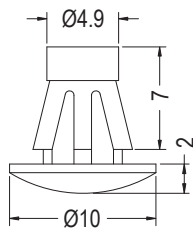

Part No.	Package
RAS-7	1000

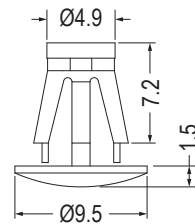

Part No.	Package
RAS-7.2	1000

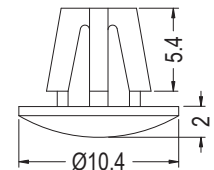

Part No.	Package
RAS-5	1000

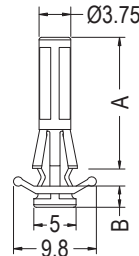
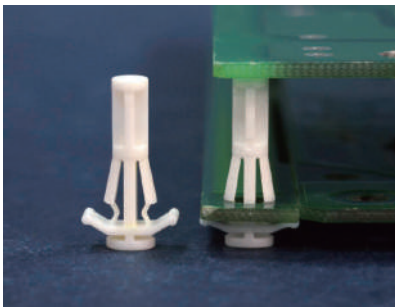

Part No.	A	B	Package
RAMC-12.5	12.5	2.5	1000
RAMC-15.5	15.5	2.5	
RAMC-18-4	18.0	4.0	
RAMC-18-8.5	18.0	8.5	
RAMC-19	19.0	2.5	
RAMC-24	24.0	2.5	

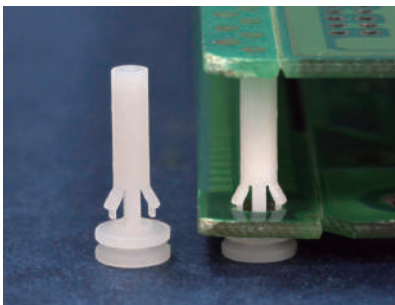

- Material: Nylon 66 (UL)
- Flame Class: 94V-2/94V-0
- Color: Natural/Black
- Unit: mm

用途：用於PCB之架高間隔，體積小，不佔空間。

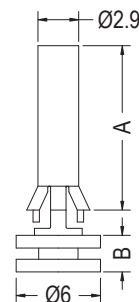

Part No.	A	B	Package
EDC-4	4.0	2.5	1000
EDC-5	5.0	2.5	
EDC-6	6.0	2.5	
EDC-7	7.0	2.5	
EDC-8	8.0	2.5	
EDC-9	9.0	2.5	
EDC-10	10.0	2.5	
EDC-11.4	11.4	2.5	
EDC-12.7	12.7	2.5	
EDC-13.5	13.5	2.5	
EDC-14.5	14.5	2.5	
EDC-15	15.0	2.5	
EDC-15-4	15.0	4.0	
EDC-15.9	15.9	2.5	

PC板間隔柱 SPACER SUPPORT

用途：一端固定於機板上，另一端支撐PC板，避免下陷造成短路，PC板免鑽孔。

1

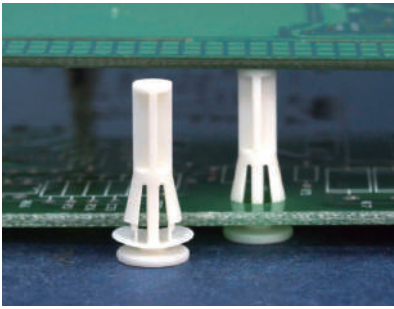

- Material: Nylon 66 (UL)
- Flame Class: 94V-2/94V-0
- Color: Natural/Black
- Unit: mm

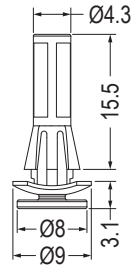

MOUNTING HOLE Ø4.8
THICKNESS 1.6

Part No.	Package
RAMD-15.5	1000

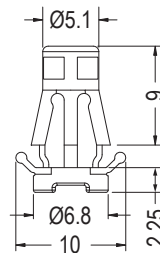
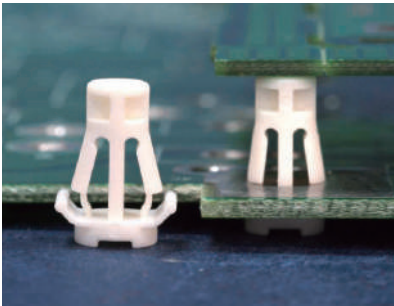

MOUNTING HOLE Ø5.6
THICKNESS 0.8~1.6

Part No.	Package
RAMB-9	1000

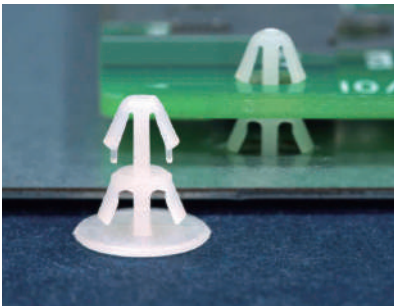

- Material: Nylon 66 (UL)
- Flame Class: 94V-2/94V-0
- Color: Natural/Black
- Unit: mm

用途：固定PC板於機板上，不會突出機板底部，外觀美麗。

MOUNTING HOLE Ø3.0
THICKNESS 1.6

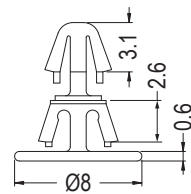

MOUNTING HOLE Ø4.0
THICKNESS 0.5

Part No.	Package
RCI-2.6	2000

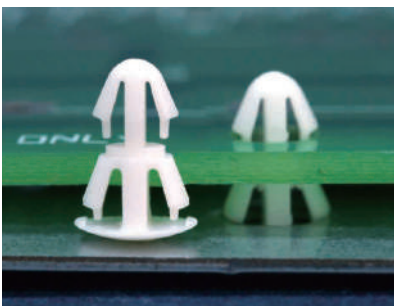

MOUNTING HOLE Ø3.0
THICKNESS 1.6

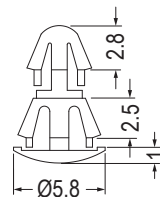

MOUNTING HOLE Ø4.0
THICKNESS 0.6~0.8

Part No.	Package
RCO-2.5	2000

MOUNTING HOLE Ø3.0
THICKNESS 1.6~2.0

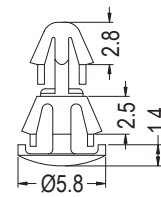

MOUNTING HOLE Ø4.0
THICKNESS 0.8~1.2

Part No.	Package
RCO-2.5L	2000

PC板間隔柱 SPACER SUPPORT

用途：固定PC板於機板上，不會突出機板底部，外觀美麗。

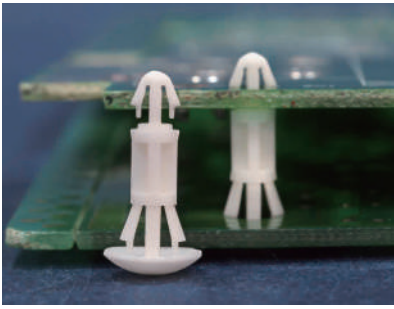

- Material: Nylon 66 (UL)
- Flame Class: 94V-2/94V-0
- Color: Natural/Black
- Unit: mm

MOUNTING HOLE Ø3.0
THICKNESS 1.6

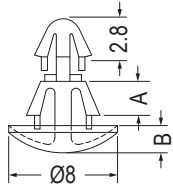

MOUNTING HOLE Ø4.0
THICKNESS 0.8~1.6

【 RCA-2.5, RCA-2.5U 】

MOUNTING HOLE Ø3.0
THICKNESS 1.6

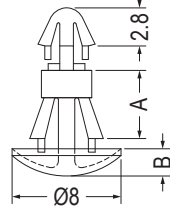

MOUNTING HOLE Ø4.0
THICKNESS 0.8~1.6

Part No.	A	B	Package
RCA-2.5U	2.5	1.8	2000
RCA-2.5	2.5	2.0	
RCA-3	3.2	2.0	
RCA-4	4.0	2.0	
RCA-4.5	4.5	2.0	
RCA-5	5.0	2.0	
RCA-5.5	5.5	2.0	

MOUNTING HOLE Ø3.0
THICKNESS: T

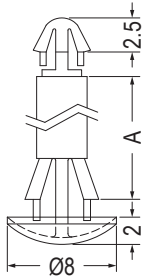

MOUNTING HOLE Ø4.0
THICKNESS 1.6~2.2

【 RCA-65.5 】

MOUNTING HOLE Ø3.0
THICKNESS: T

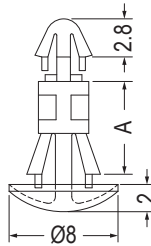

MOUNTING HOLE Ø4.0
THICKNESS 0.8~1.6

Part No.	A	T	Package
RCA-6	6.0	1.6	2000
RCA-6.4	6.4	1.6	
RCA-7	7.0	1.6	1000
RCA-7.5	7.5	1.6	
RCA-8	8.0	1.6	
RCA-8L	8.0	1.83	
RCA-9	9.0	1.6	
RCA-9.5	9.5	1.6	
RCA-10	10.0	1.6	
RCA-11.1	11.1	1.6	
RCA-12	12.0	1.6	
RCA-12.7	12.7	1.6	
RCA-14	14.0	1.6	
RCA-15.5	15.5	1.6	
RCA-16	16.0	1.6	
RCA-65.5	65.5	1.6	

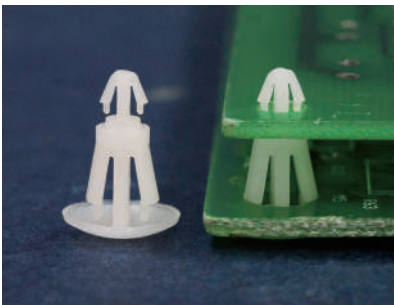

MOUNTING HOLE Ø3.0
THICKNESS 1.6

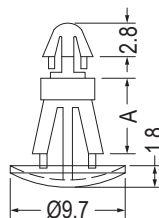

MOUNTING HOLE Ø4.8
THICKNESS 0.8~2.0

MOUNTING HOLE Ø3.0
THICKNESS 1.6

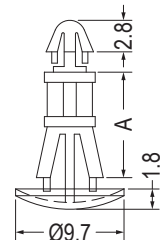

MOUNTING HOLE Ø4.8
THICKNESS 0.8~2.0

Part No.	A	Package
RCC-5	5.0	2000
RCC-6	6.3	
RCC-8	8.0	

Part No.	A	Package
RCC-10	10.0	1000
RCC-12	12.7	

PC板間隔柱 SPACER SUPPORT

用途：固定PC板於機板上，不會突出機板底部，外觀美麗。

1

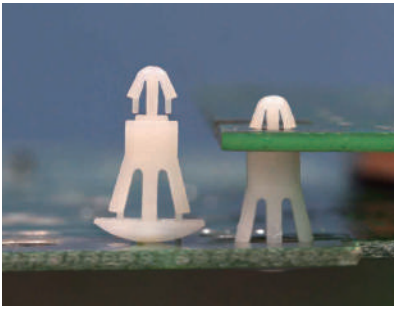

- Material: Nylon 66 (UL)
- Flame Class: 94V-2/94V-0
- Color: Natural/Black
- Unit: mm

MOUNTING HOLE Ø3.0
THICKNESS 1.2~1.7

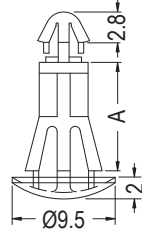

MOUNTING HOLE Ø5.5
THICKNESS 0.6~1.2

Part No.	A	Package
RCG-3.5	3.5	1000
RCG-5	4.8	
RCG-6.35	6.35	
RCG-7	7.0	
RCG-8	8.0	
RCG-10	10.0	
RCG-11	11.0	
RCG-12.7	12.7	
RCG-15.9	15.9	

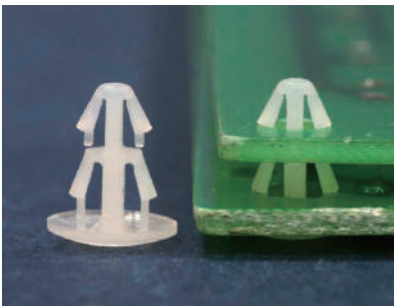

MOUNTING HOLE Ø3.2
THICKNESS 0.8~1.0

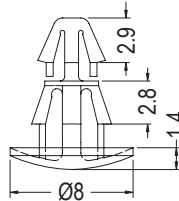

MOUNTING HOLE Ø4.0
THICKNESS 1.8

Part No.	Package
RCMB-2.8	1000

MOUNTING HOLE Ø3.2
THICKNESS 1.6

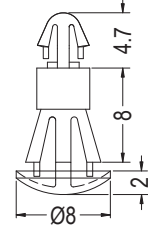

MOUNTING HOLE Ø4.8
THICKNESS 1.2~1.4

Part No.	Package
RCCA-8	1000

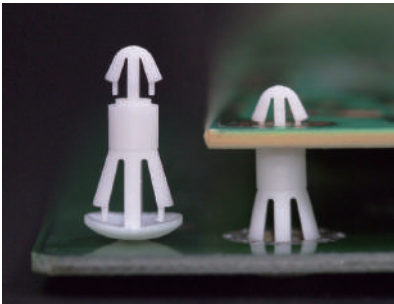

MOUNTING HOLE Ø3.5
THICKNESS 1.6

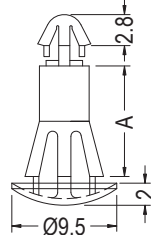

MOUNTING HOLE Ø5.5
THICKNESS 0.8~1.2

【 RCH-3.5~RCH-8 】

MOUNTING HOLE Ø3.5
THICKNESS 1.6

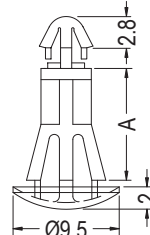

MOUNTING HOLE Ø5.5
THICKNESS 0.8~1.2

【 RCH-10~RCH-15.9 】

Part No.	A	Package
RCH-3.5	3.5	1000
RCH-5	4.8	
RCH-6.35	6.35	
RCH-7	7.0	
RCH-8	8.0	
RCH-10	10.0	
RCH-11	11.0	
RCH-12.7	12.7	
RCH-15.9	15.9	



MOUNTING HOLE Ø4.0
THICKNESS 1.2~1.6

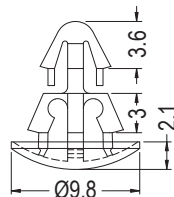

MOUNTING HOLE Ø5.5
THICKNESS 0.8~1.6

Part No.	Package
RCMA-3	1000

PC板間隔柱 SPACER SUPPORT

用途：固定PC板於機板上，不會突出機板底部，外觀美麗。

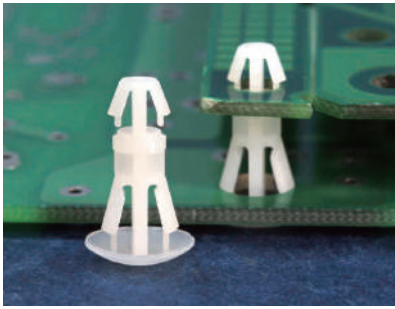

- Material: Nylon 66 (UL)
- Flame Class: 94V-2/94V-0
- Color: Natural/Black
- Unit: mm

MOUNTING HOLE Ø4.0
THICKNESS 1.7

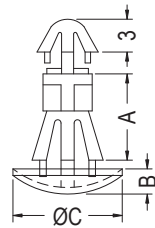

MOUNTING HOLE Ø5.0
THICKNESS 0.8~1.8

Part No.	A	B	C	Package
RCS-6	6.0	2.3	9.7	1000
RCS-13.8	13.8	2.2	10.0	
RCS-16	16.0	2.3	9.7	

MOUNTING HOLE Ø4.0
THICKNESS 1.0~1.8

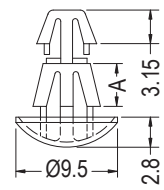

MOUNTING HOLE Ø4.8
THICKNESS 0.8~1.2

[RCD-3, RCD-4]

MOUNTING HOLE Ø4.0
THICKNESS 1.0~1.8

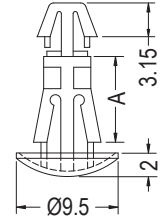

MOUNTING HOLE Ø4.8
THICKNESS 0.8~1.2

Part No.	A	Package
RCD-3	3.0	1000
RCD-4	4.0	
RCD-6	6.3	
RCD-8	8.0	
RCD-10	10.0	
RCD-11	11.0	

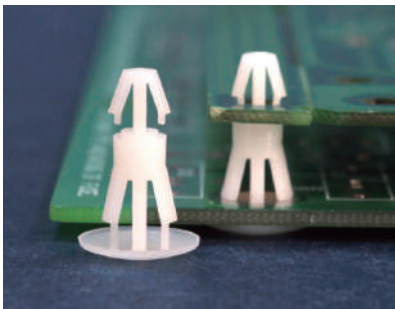

MOUNTING HOLE Ø4.0
THICKNESS 1.6

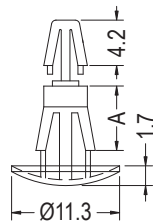

MOUNTING HOLE Ø5.5
THICKNESS 1.5~2.2

[RCB-3~RCB-8]

Part No.	A	Package
RCB-3	3.5	1000
RCB-5	5.0	
RCB-6	6.35	
RCB-8	8.0	
RCB-10	10.0	

MOUNTING HOLE Ø4.0
THICKNESS 1.6

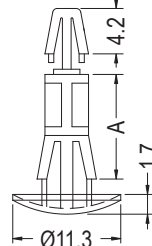

MOUNTING HOLE Ø5.5
THICKNESS 1.5~2.2

Part No.	A	Package
RCB-12	12.7	1000
RCB-15	15.9	
RCB-19	19.0	
RCB-25	25.4	500
RCB-35	35.5	

MOUNTING HOLE Ø4.0
THICKNESS 1.6

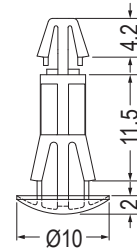

MOUNTING HOLE Ø5.5
THICKNESS 1.5~2.2

- Material: Nylon 46 (UL)
- Flame Class: 94V-2
- Color: Black

Part No.	Package
RCB-11.5	1000

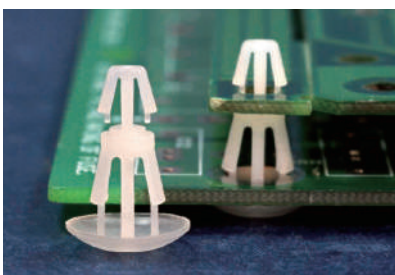
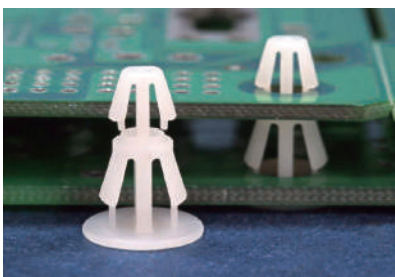

MOUNTING HOLE Ø4.0
THICKNESS 1.6

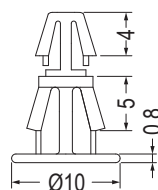

MOUNTING HOLE Ø5.5
THICKNESS 1.5~2.2

Part No.	Package
RCI-5	1000

MOUNTING HOLE Ø4.0
THICKNESS 1.6

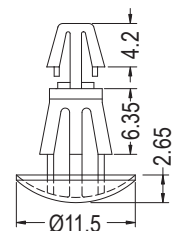

MOUNTING HOLE Ø5.5
THICKNESS 2.0~3.0

Part No.	Package
RCBL-6	1000

PC板間隔柱 SPACER SUPPORT

用途：固定PC板於機板上，不會突出機板底部，外觀美麗。

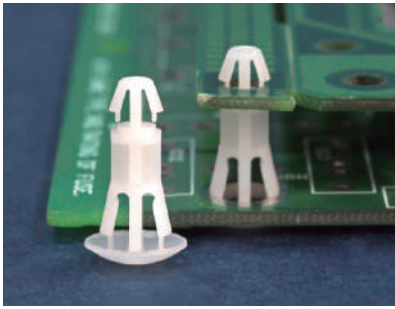

- Material: Nylon 66 (UL)
- Flame Class: 94V-2/94V-0
- Color: Natural/Black
- Unit: mm

MOUNTING HOLE Ø4.0
THICKNESS 1.2~1.7

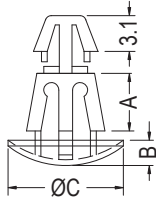

MOUNTING HOLE Ø5.5
THICKNESS 0.8~1.6

MOUNTING HOLE Ø4.0
THICKNESS 1.2~1.7

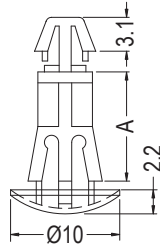

MOUNTING HOLE Ø5.5
THICKNESS: T

Part No.	A	B	C	Package
RCM-3	3.5	2.2	10.0	1000
RCM-5	5.0	2.2	10.0	
RCM-5SP	5.0	1.5	8.0	

Part No.	A	T	Package
RCM-6	6.35	0.8~1.6	1000
RCM-6L	6.35	1.6~2.0	
RCM-7	7.0	0.8~1.6	
RCM-8	8.0	0.8~1.6	
RCM-8.5	8.5	0.8~1.6	
RCM-10	10.0	0.8~1.6	
RCM-12A	12.0	0.8~1.6	
RCM-12	12.7	0.8~1.6	
RCM-13.5	13.5	0.8~1.6	
RCM-14	14.0	0.8~1.6	
RCM-15	15.2	0.8~1.6	
RCM-16	15.9	0.8~1.6	
RCM-18	18.0	0.8~1.6	
RCM-19	19.0	0.8~1.6	
RCM-20	20.0	0.8~1.6	
RCM-22	21.7	0.8~1.6	
RCM-24	24.0	0.8~1.6	
RCM-25	25.4	0.8~1.6	
RCM-30	30.0	0.8~1.6	

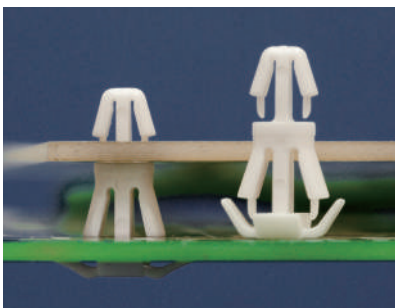

MOUNTING HOLE Ø4.0
THICKNESS 1.8

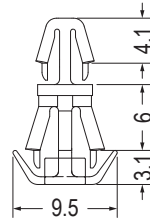

MOUNTING HOLE Ø5.5
THICKNESS 0.5~2.0

Part No.	Package
RCMD-6	1000

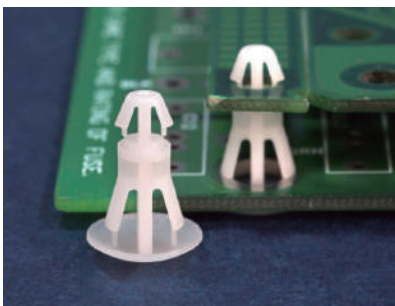

MOUNTING HOLE Ø4.0
THICKNESS 1.2~1.7

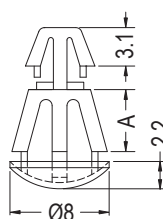

MOUNTING HOLE Ø6.0
THICKNESS 0.8~1.6

【 RCF-5S 】

MOUNTING HOLE Ø4.0
THICKNESS 1.2~1.7

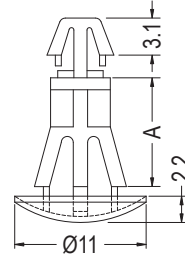

MOUNTING HOLE Ø6.0
THICKNESS 0.8~2.0

Part No.	A	Package
RCF-5	5.0	2000
RCF-5S	5.0	
RCF-6	6.35	1000
RCF-8	8.0	
RCF-10	10.0	
RCF-12	12.7	
RCF-15	15.9	

PC板間隔柱 SPACER SUPPORT

用途：固定PC板於機板上，不會突出機板底部，外觀美麗。

- Material: Nylon 66 (UL)
- Flame Class: 94V-2/94V-0
- Color: Natural/Black
- Unit: mm

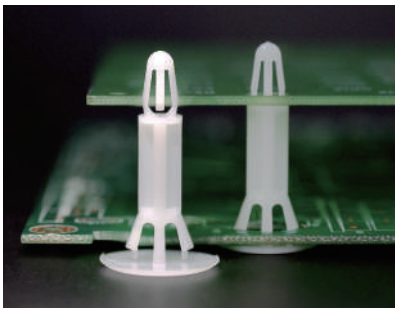
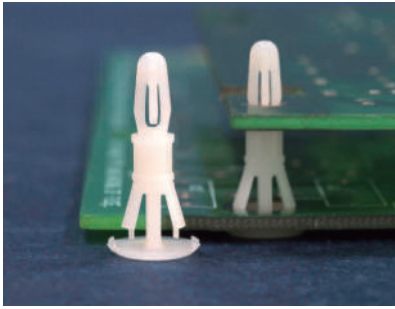
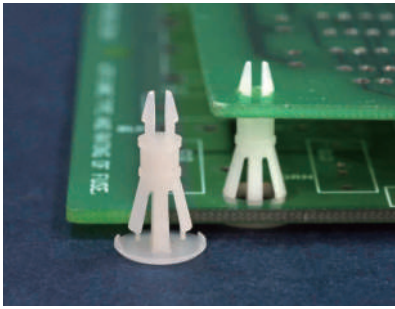

MOUNTING HOLE Ø3.2
THICKNESS 1.6

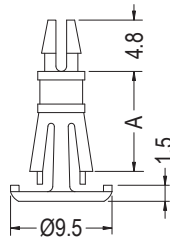

MOUNTING HOLE Ø4.8
THICKNESS 1.5~1.6

Part No.	A	Package
RCBS-6.5	6.5	1000
RCBS-9.5	9.5	
RCBS-12.7	12.7	

MOUNTING HOLE Ø6.2
THICKNESS 1.6

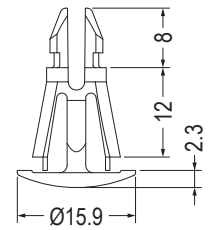

MOUNTING HOLE Ø9.0
THICKNESS 1.4

Part No.	Package
RCBC-12	1000

MOUNTING HOLE Ø3.2
THICKNESS 1.6

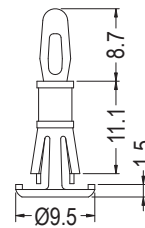

MOUNTING HOLE Ø4.8
THICKNESS 1.5~1.6

Part No.	Package
RCV-11.1	1000

MOUNTING HOLE Ø3.2
THICKNESS 1.7

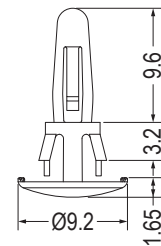

MOUNTING HOLE Ø4.8
THICKNESS 1.7

Part No.	Package
RCR-3.2	1000

MOUNTING HOLE Ø3.2
THICKNESS 1.2~1.7

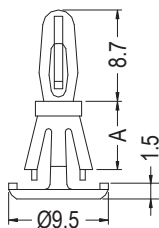

MOUNTING HOLE Ø4.8
THICKNESS 1.5~1.6

Part No.	A	Package
RCW-6.5	6.5	1000
RCW-7.9	7.9	
RCW-9.7	9.7	
RCW-11.1	11.1	
RCW-12.7	12.7	
RCW-14.3	14.3	
RCW-15.9	15.9	

MOUNTING HOLE Ø4.0
THICKNESS 1.6

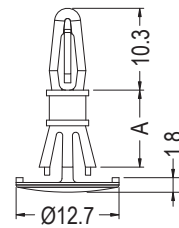

MOUNTING HOLE Ø5.4
THICKNESS 1.5~1.6

Part No.	A	Package
RCWA-6.4	6.4	1000
RCWA-9.5	9.5	
RCWA-12.7	12.7	
RCWA-15.9	15.9	
RCWA-19	19.1	
RCWA-22.2	22.2	
RCWA-25.4	25.4	

MOUNTING HOLE Ø5.3
THICKNESS 1.6

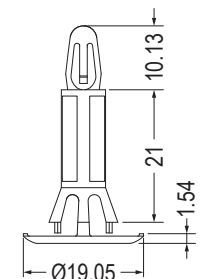

MOUNTING HOLE Ø9.0
THICKNESS 1.8

Part No.	Package
RCWB-21	1000

PC板間隔柱 SPACER SUPPORT

用途：固定PC板於機板上，不會突出機板底部，外觀美麗。

- Material: Nylon 66 (UL)
- Flame Class: 94V-2/94V-0
- Color: Natural/Black
- Unit: mm

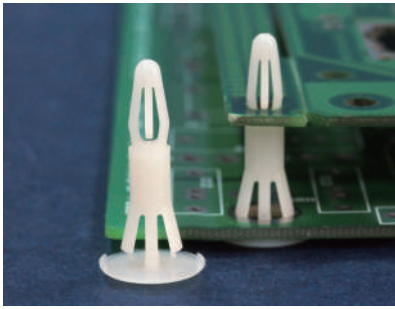

MOUNTING HOLE Ø4.0
THICKNESS 1.2~1.7

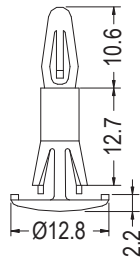

MOUNTING HOLE Ø5.5
THICKNESS 1.0~1.5

Part No.	Package
RCR-12.7	1000

MOUNTING HOLE Ø4.0
THICKNESS 1.2~1.6

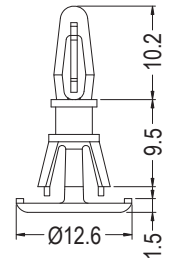

MOUNTING HOLE Ø6.35
THICKNESS 1.0~1.6

Part No.	Package
RCRA-9.5	1000

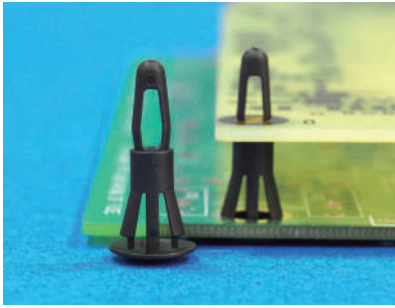

MOUNTING HOLE Ø4.0
THICKNESS 1.6

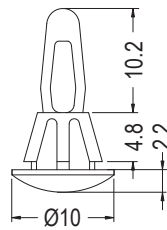

MOUNTING HOLE Ø6.0
THICKNESS 0.8~1.2

Part No.	Package
PCBTA-4.8	1000

MOUNTING HOLE Ø4.0
THICKNESS 1.6

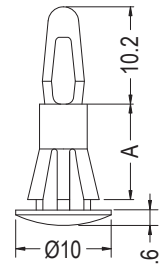

MOUNTING HOLE Ø5.5
THICKNESS 1.0~1.7

Part No.	A	Package
PCBT-4.8	4.8	1000
PCBT-10	10.0	

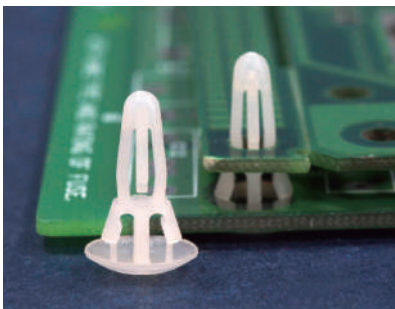

MOUNTING HOLE Ø4.0
THICKNESS 1.2~1.7

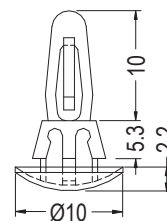

MOUNTING HOLE Ø5.5
THICKNESS 0.8~1.6

Part No.	Package
PCBS-3	1000

MOUNTING HOLE Ø4.0
THICKNESS 1.6

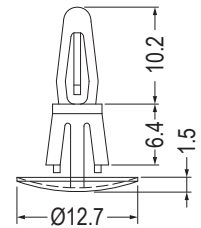

MOUNTING HOLE Ø5.4
THICKNESS 1.2~2.0

Part No.	Package
PCBS-6.4	1000

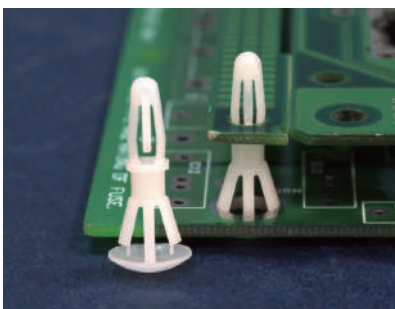

MOUNTING HOLE Ø4.0
THICKNESS 1.6

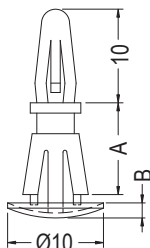

MOUNTING HOLE Ø5.5
THICKNESS 1.0~1.7

Part No.	A	B	Package
PCBS-6	6.3	1.6	1000
PCBS-8	7.9	2.1	
PCBS-10	10.0	2.1	
PCBS-12A	12.0	2.1	
PCBS-12	12.7	1.6	

PC板間隔柱 SPACER SUPPORT

用途：固定PC板於機板上，不會突出機板底部，外觀美麗。

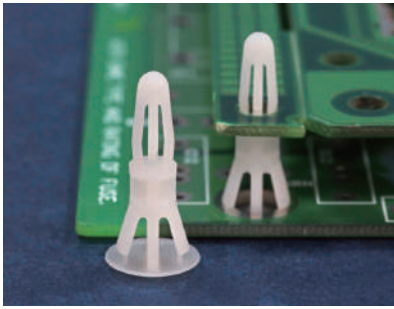

- Material: Nylon 66 (UL)
- Flame Class: 94V-2/94V-0
- Color: Natural/Black
- Unit: mm

MOUNTING HOLE Ø4.0
THICKNESS 1.6

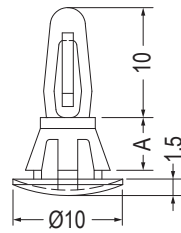

MOUNTING HOLE Ø6.0
THICKNESS 0.8-1.2

Part No.	A	Package
RCFL-4.8	4.8	1000
RCFL-6.4	6.4	

MOUNTING HOLE Ø4.0
THICKNESS 1.6

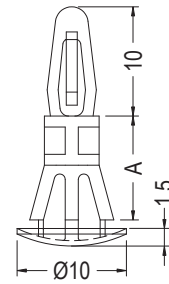

MOUNTING HOLE Ø6.0
THICKNESS 0.8-1.2

Part No.	A	Package
RCFL-8	8.0	1000
RCFL-9.5	9.5	
RCFL-12.7	12.7	
RCFL-15.9	15.9	
RCFL-19	19.0	

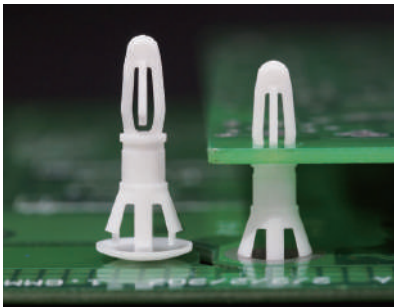

MOUNTING HOLE Ø4.0
THICKNESS 1.6

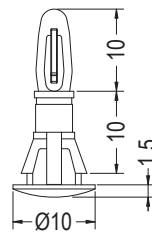

MOUNTING HOLE Ø6.5
THICKNESS 1.6-2.0

Part No.	Package
RCFB-10	1000

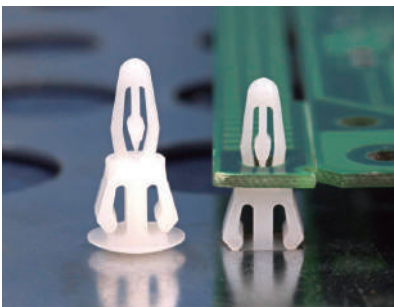

MOUNTING HOLE Ø4.0
THICKNESS 1.6

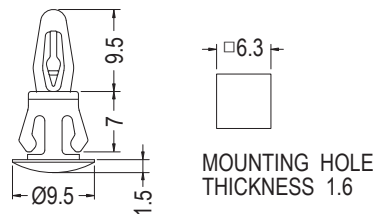

MOUNTING HOLE
THICKNESS 1.6

Part No.	Package
RCFA-7	1000

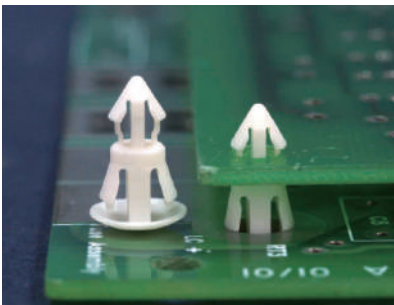

MOUNTING HOLE Ø3.5
THICKNESS 1.6-1.8

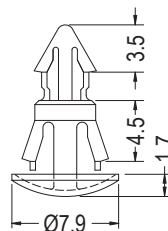

MOUNTING HOLE Ø5.5
THICKNESS 0.8

Part No.	Package
RCTA-4.5	1000

MOUNTING HOLE Ø3.5
THICKNESS 1.2-1.7

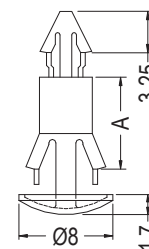

MOUNTING HOLE Ø4.8-Ø5.0
THICKNESS 1.2-1.7

Part No.	A	Package
RCT-4.5	4.5	1000
RCT-8	7.9	

PC板間隔柱 SPACER SUPPORT

用途：固定PC板於機板上，不會突出機板底部，外觀美麗。



- Material: Nylon 66 (UL)
- Flame Class: 94V-2/94V-0
- Color: Natural/Black
- Unit: mm

MOUNTING HOLE Ø4.0
THICKNESS 1.2~1.7

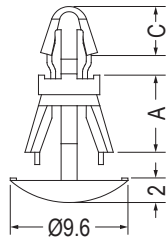

MOUNTING HOLE Ø5.4
THICKNESS 2.0

Part No.	A	C	Package
RCTL-6S	6.0	3.9	1000
RCTL-6	6.3	4.0	
RCTL-12	12.0	3.9	
RCTL-12	12.0	3.9	

MOUNTING HOLE Ø4.0
THICKNESS 1.6

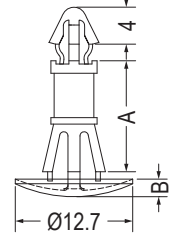

MOUNTING HOLE Ø5.4
THICKNESS 0.8~1.6

Part No.	A	B	Package
RCJ-8	8.0	2.1	1000
RCJ-10	10.0	1.7	
RCJ-12	12.0	1.7	
RCJ-12.7	12.7	1.7	
RCJ-12.7	12.7	1.7	

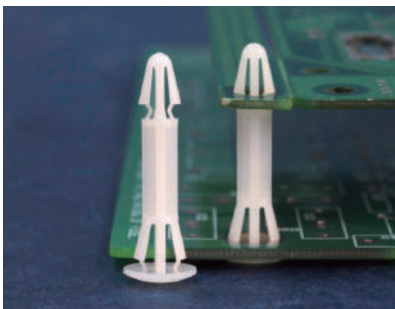

MOUNTING HOLE Ø4.0
THICKNESS 1.2~1.6

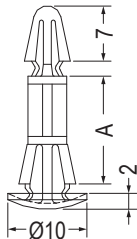

MOUNTING HOLE Ø5.5
THICKNESS 1.2~1.6

Part No.	A	Package
RBT-19	19.0	1000
RBT-28.2	28.2	

MOUNTING HOLE Ø4.0
THICKNESS 3.0

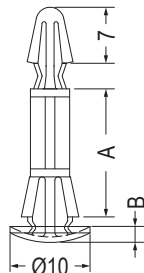

MOUNTING HOLE Ø5.5
THICKNESS 1.2~1.6

Part No.	A	B	Package
RBT-16L	16.0	1.8	1000
RBT-25L	25.0	2.0	

MOUNTING HOLE Ø4.0
THICKNESS 1.2~1.7

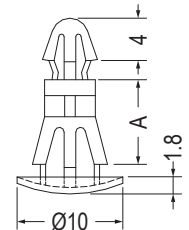

MOUNTING HOLE Ø5.5
THICKNESS 1.2~1.8

Part No.	A	Package
RBS-5	5.0	1000
RBS-6	6.0	
RBS-7	7.0	
RBS-8	8.0	
RBS-10	10.0	
RBS-11	11.0	
RBS-12	12.0	
RBS-14	14.0	
RBS-18	18.0	
RBS-20	20.0	
RBS-23	23.0	

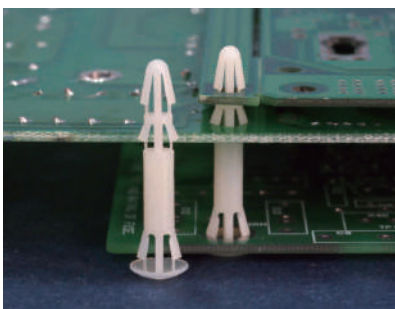

- Material: Nylon 66 (UL)
- Flame Class: 94V-2/94V-0
- Color: Natural/Black
- Unit: mm

用途：用於三層PC板，與機板間之固定，方便、節省空間。

MOUNTING HOLE Ø4.0
THICKNESS 1.6

MOUNTING HOLE Ø4.5
THICKNESS 1.6

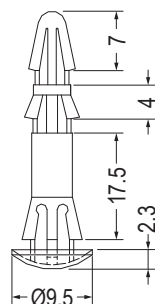

MOUNTING HOLE Ø5.0
THICKNESS 1.6

Part No.	Package
DRCB-18	1000

PC板間隔柱 SPACER SUPPORT

用途：固定PC板於機板上，不會突出機板底部，外觀美麗。

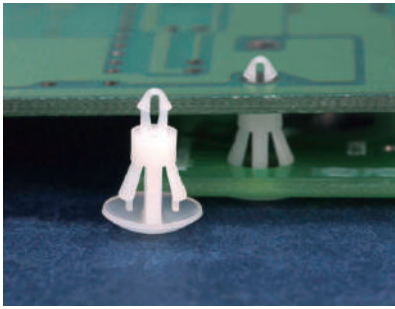

- Material: Nylon 66 (UL)
- Flame Class: 94V-2/94V-0
- Color: Natural/Black
- Unit: mm

MOUNTING HOLE Ø2.0
THICKNESS 1.6

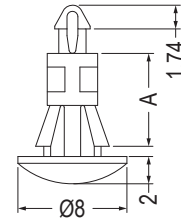

MOUNTING HOLE Ø2.0
THICKNESS 1.6

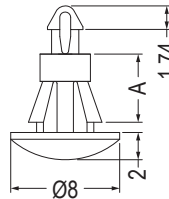

MOUNTING HOLE Ø4.0
THICKNESS 0.8~1.6

Part No.	A	Package
RCAB-6	6.0	1000
RCAB-6.4	6.4	
RCAB-7	7.0	
RCAB-7.5	7.5	
RCAB-8	8.0	
RCAB-9	9.0	
RCAB-9.5	9.5	
RCAB-10	10.0	
RCAB-11.1	11.1	
RCAB-12	12.0	
RCAB-12.7	12.7	
RCAB-14	14.0	
RCAB-16	16.0	

MOUNTING HOLE Ø2.0
THICKNESS 1.0

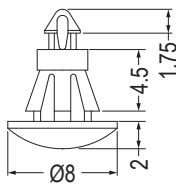

MOUNTING HOLE Ø4.0
THICKNESS 0.8~1.6

Part No.	A	Package
RCAB-3	3.2	1000
RCAB-4	4.0	
RCAB-4.5	4.5	
RCAB-5	5.0	
RCAB-5.5	5.5	

MOUNTING HOLE Ø4.0
THICKNESS 0.8~1.6

Part No.	Package
RCAB-4.5S	1000

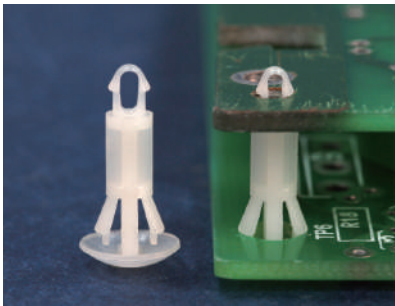

MOUNTING HOLE Ø2.5
THICKNESS 1.6

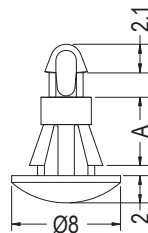

MOUNTING HOLE Ø2.5
THICKNESS 1.6

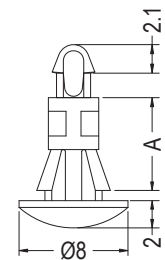

MOUNTING HOLE Ø4.0
THICKNESS 0.8~1.6

Part No.	A	Package
RCAC-3	3.0	1000
RCAC-4	4.0	
RCAC-4.5	4.5	
RCAC-5	5.0	
RCAC-5.5	5.5	

MOUNTING HOLE Ø4.0
THICKNESS 0.8~1.6

Part No.	A	Package
RCAC-6	6.0	1000
RCAC-6.4	6.4	
RCAC-7	7.0	
RCAC-7.5	7.5	
RCAC-8	8.0	
RCAC-9	9.0	
RCAC-9.5	9.5	
RCAC-10	10.0	
RCAC-11.1	11.1	
RCAC-12	12.0	
RCAC-12.7	12.7	
RCAC-14	14.0	
RCAC-16	16.0	

PC板間隔柱 SPACER SUPPORT

用途：PC板與PC板間之固定，不佔空間。

1

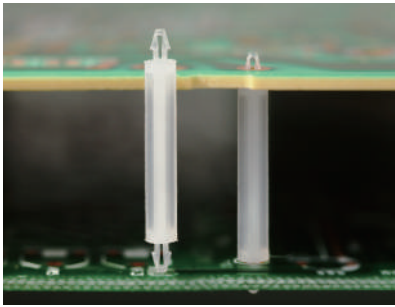

- Material: Nylon 66 (UL)
- Flame Class: 94V-2/94V-0
- Color: Natural/Black
- Unit: mm

MOUNTING HOLE Ø1.5
THICKNESS 1.0

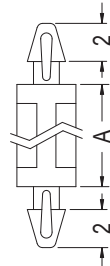

MOUNTING HOLE Ø1.5
THICKNESS 1.0

Part No.	A	Package
MASSD-14	14.0	2000
MASSD-18	18.0	1000

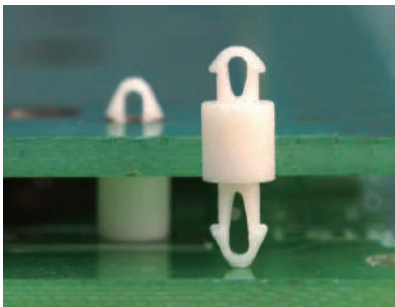

MOUNTING HOLE Ø1.6
THICKNESS 1.0

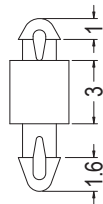

MOUNTING HOLE Ø1.6
THICKNESS 1.6

Part No.	Package
MADSA-3	1000

MOUNTING HOLE Ø1.6
THICKNESS 1.0

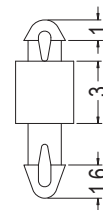

MOUNTING HOLE Ø1.6
THICKNESS 2.0

Part No.	Package
MADSB-3	2000

MOUNTING HOLE Ø1.6
THICKNESS 0.7

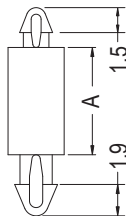

MOUNTING HOLE Ø2.0
THICKNESS 1.6

Part No.	A	Package
MADS-6.5	6.5	2000
MADS-19.2	19.2	1000

MOUNTING HOLE Ø1.6
THICKNESS 1.5

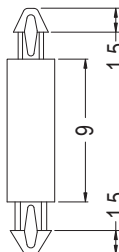

MOUNTING HOLE Ø2.0
THICKNESS 1.6

Part No.	Package
MAS-9	1000

MOUNTING HOLE Ø1.7
THICKNESS 1.7

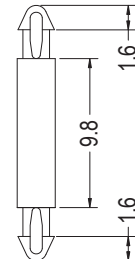

MOUNTING HOLE Ø1.7
THICKNESS 1.7

Part No.	Package
MAD1.7-9.8	1000

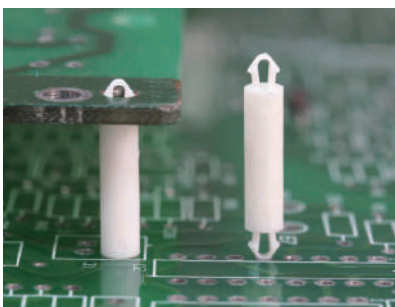

MOUNTING HOLE Ø2.0
THICKNESS 1.0

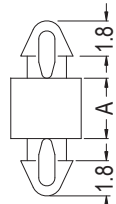

MOUNTING HOLE Ø2.0
THICKNESS 1.0

Part No.	A	Package
MAD1-3	3.0	2000
MAD1-19	19.0	1000

MOUNTING HOLE Ø2.0
THICKNESS 1.0~1.2

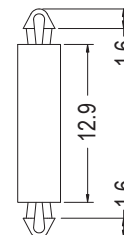

MOUNTING HOLE Ø2.0
THICKNESS 1.0~1.2

Part No.	Package
MAD1.2-12.9	1000

PC板間隔柱 SPACER SUPPORT

用途：PC板與PC板間之固定，不佔空間。

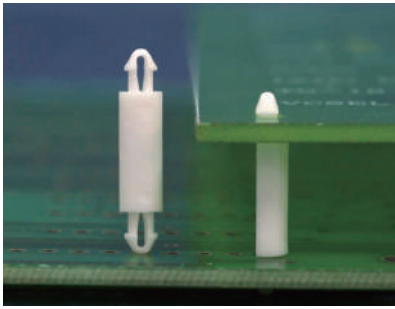

- Material: Nylon 66 (UL)
- Flame Class: 94V-2/94V-0
- Color: Natural/Black
- Unit: mm

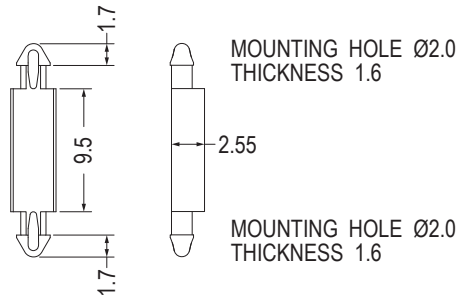

Part No.	Package
MADX-9.5	1000

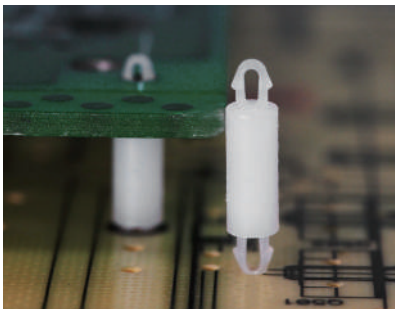

MOUNTING HOLE Ø2.0 THICKNESS 1.2

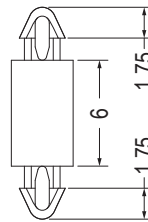

MOUNTING HOLE Ø2.0 THICKNESS 1.2

Part No.	Package
MAD1.2-6	1000

MOUNTING HOLE Ø2.0 THICKNESS 1.2

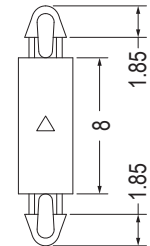

MOUNTING HOLE Ø2.0 THICKNESS 1.2

Part No.	Package
MAD1.2-8	1000

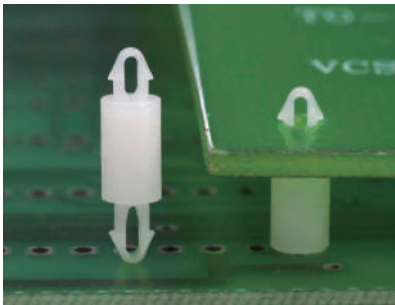

MOUNTING HOLE Ø2.0 THICKNESS 1.6

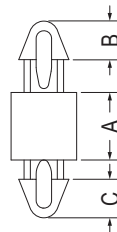

MOUNTING HOLE Ø2.0 THICKNESS: T

Part No.	A	B	C	T	Package
MADB-3.5	3.5	2.0	2.0	0.9	2000
MADB-6	6.0	1.9	1.9	0.8	

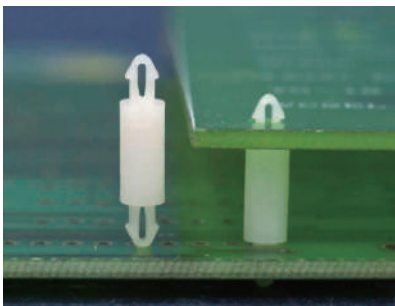

MOUNTING HOLE Ø2.0 THICKNESS 1.6

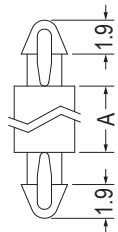

MOUNTING HOLE Ø2.0 THICKNESS 1.6

MOUNTING HOLE Ø2.0 THICKNESS 1.6

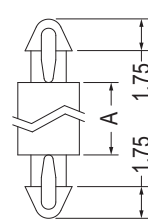

MOUNTING HOLE Ø2.0 THICKNESS 1.6

【 MAD-14 】

Part No.	A	Package
MAD-1.6	1.6	2000
MAD-2.2	2.2	
MAD-3	3.0	
MAD-3.5	3.5	
MAD-4	4.0	
MAD-5	5.0	
MAD-6	6.0	
MAD-6.5	6.5	
MAD-7	7.0	
MAD-8	8.0	
MAD-10S	10.0	
MAD-10	10.5	
MAD-12.5	12.5	
MAD-14	14.0	
MAD-25	25.0	

PC板間隔柱 SPACER SUPPORT

用途：PC板與PC板間之固定，不佔空間。

1

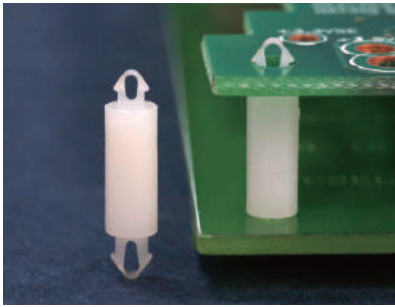

- Material: Nylon 66 (UL)
- Flame Class: 94V-2/94V-0
- Color: Natural/Black
- Unit: mm

MOUNTING HOLE $\varnothing 2.0$
THICKNESS 1.0

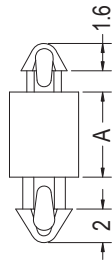

MOUNTING HOLE $\varnothing 2.5$
THICKNESS 1.6

Part No.	A	Package
MAMDA-1.6	1.6	1000
MAMDA-2.5	2.5	
MAMDA-3.2	3.2	
MAMDA-4	4.0	
MAMDA-4.8	4.8	
MAMDA-5.5	5.5	
MAMDA-6.4	6.4	
MAMDA-7	7.0	
MAMDA-7.9	7.9	
MAMDA-9.5	9.5	
MAMDA-10	10.0	
MAMDA-12.7	12.7	

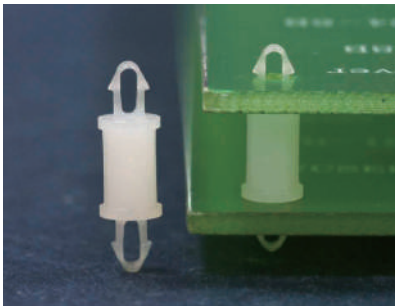

MOUNTING HOLE $\varnothing 2.2$
THICKNESS 1.6

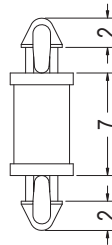

MOUNTING HOLE $\varnothing 2.2$
THICKNESS 1.6

Part No.	Package
MAHA-7	1000

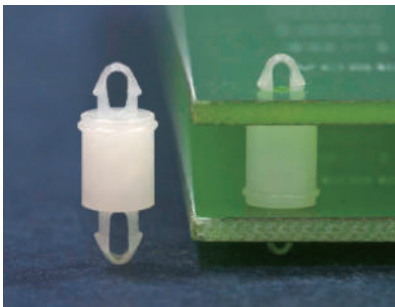

MOUNTING HOLE $\varnothing 2.5$
THICKNESS 1.0

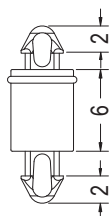

MOUNTING HOLE $\varnothing 2.5$
THICKNESS 1.6

Part No.	Package
MADJ-6	2000

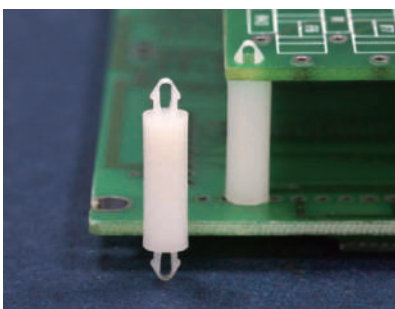

MOUNTING HOLE $\varnothing 2.5$
THICKNESS 0.6

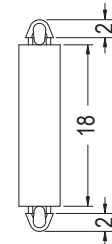

MOUNTING HOLE $\varnothing 2.5$
THICKNESS 0.6

Part No.	Package
MADA-18S	2000

MOUNTING HOLE $\varnothing 2.5$
THICKNESS 1.6

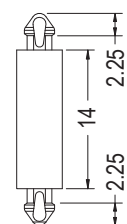

MOUNTING HOLE $\varnothing 2.5$
THICKNESS 1.6

Part No.	Package
MADAA-14	1000

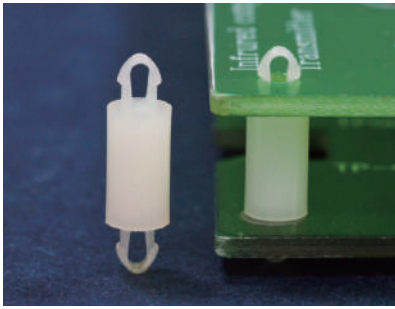

- Material: Nylon 66 (UL)
- Flame Class: 94V-2/94V-0
- Color: Natural/Black
- Unit: mm

MOUNTING HOLE Ø2.5
THICKNESS 1.6

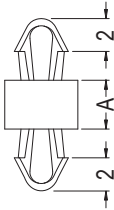

MOUNTING HOLE Ø2.5
THICKNESS 1.6

【 MADA-3-1 】

MOUNTING HOLE Ø2.5
THICKNESS 1.6

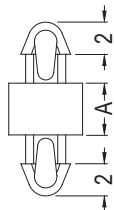

MOUNTING HOLE Ø2.5
THICKNESS 1.6

Part No.	A	Package
MADA-2	2.0	2000
MADA-3	3.0	
MADA-3-1	3.0	
MADA-3.5	3.5	
MADA-4	4.0	
MADA-5	5.0	
MADA-6	6.0	
MADA-6.7	6.7	
MADA-7	7.0	
MADA-8	8.0	
MADA-8.5	8.5	

Part No.	A	Package
MADA-9	9.0	2000
MADA-10	10.0	
MADA-11	11.0	
MADA-12	12.0	
MADA-12.7	12.7	
MADA-14	14.0	
MADA-16	16.0	
MADA-18	18.0	
MADA-20	20.0	
MADA-22	22.0	

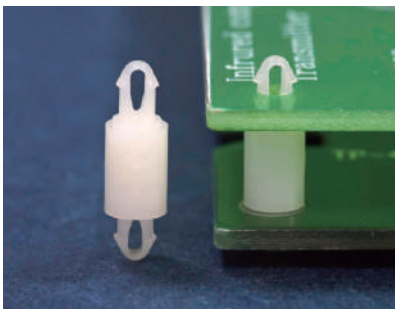

MOUNTING HOLE Ø2.5
THICKNESS 2.2

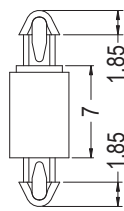

MOUNTING HOLE Ø2.5
THICKNESS 2.0

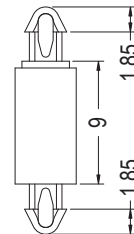

MOUNTING HOLE Ø2.5
THICKNESS 1.6

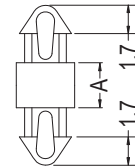

MOUNTING HOLE Ø2.5
THICKNESS 1.6

MOUNTING HOLE Ø2.5
THICKNESS 1.7

Part No.	Package
MAMDF-7	1000

MOUNTING HOLE Ø2.5
THICKNESS 1.2~1.7

Part No.	Package
MAMDL-9	1000

Part No.	A	Package
MADM-2.7S	2.7	2000
MADM-3S	3.0	

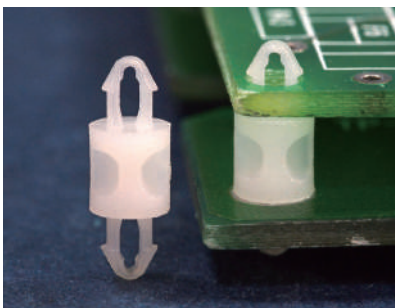

MOUNTING HOLE Ø2.5
THICKNESS 1.6

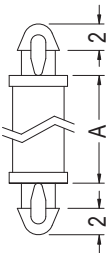

MOUNTING HOLE Ø2.5
THICKNESS 1.6

Part No.	Package
MADM-12.7	2000

MOUNTING HOLE Ø2.5
THICKNESS 1.6

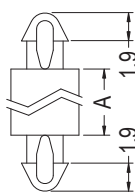

MOUNTING HOLE Ø2.5
THICKNESS 1.6

【 MADM-2~MADM-5 】

MOUNTING HOLE Ø2.5
THICKNESS 1.6

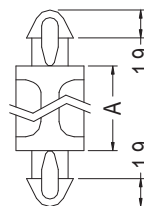

MOUNTING HOLE Ø2.5
THICKNESS 1.6

Part No.	A	Package
MADM-2	2.0	2000
MADM-3	3.0	
MADM-4	4.0	
MADM-4.5	4.5	
MADM-5	5.0	
MADM-6	6.0	
MADM-6.5	6.5	
MADM-7.5	7.5	
MADM-8	8.0	
MADM-9.5	9.5	
MADM-10A	10.0	
MADM-10	10.5	
MADM-27	27.0	

PC板間隔柱 SPACER SUPPORT

用途：PC板與PC板間之固定，不佔空間。

1

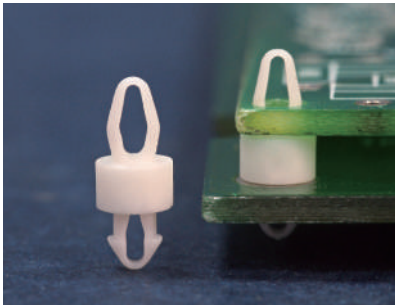

- Material: Nylon 66 (UL)
- Flame Class: 94V-2/94V-0
- Color: Natural/Black
- Unit: mm

MOUNTING HOLE Ø2.5
THICKNESS 1.0

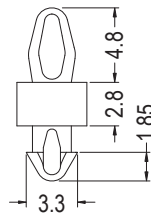

MOUNTING HOLE Ø2.5
THICKNESS 1.6

Part No.	Package
MADE-2.8	1000

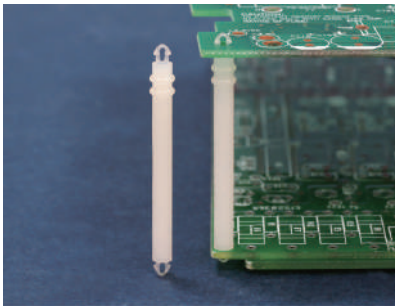

MOUNTING HOLE Ø2.5
THICKNESS 1.6

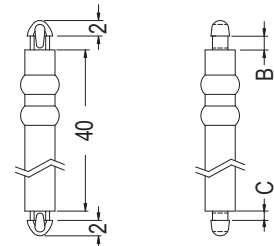

MOUNTING HOLE Ø2.5
THICKNESS 1.0

Part No.	B	C	Package
MAC-40	1.8	1.2	500
MAC-40S	1.5	1.0	

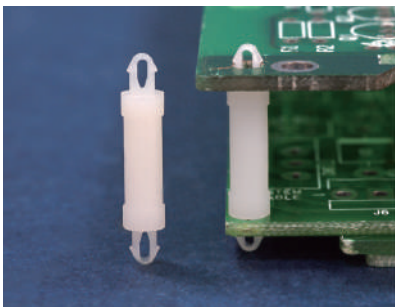

MOUNTING HOLE Ø2.5
THICKNESS 2.0



MOUNTING HOLE Ø2.5
THICKNESS 2.0

Part No.	Package
MAHC-14.3	1000

MOUNTING HOLE Ø2.6
THICKNESS 1.6

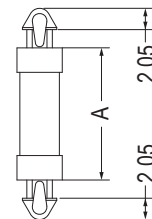

MOUNTING HOLE Ø2.6
THICKNESS 1.6

Part No.	A	Package
MAHC-6.4S	6.4	1000
MAHC-9.5S	9.5	
MAHC-12.7S	12.7	
MAHC-15.9S	15.9	

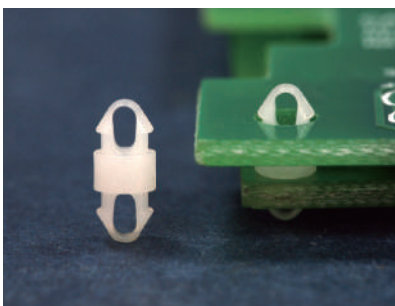

MOUNTING HOLE Ø2.6
THICKNESS 1.0

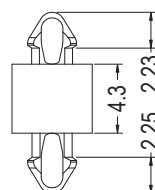

MOUNTING HOLE Ø2.5
THICKNESS 1.6

Part No.	Package
MADAB-4.3	1000

MOUNTING HOLE Ø2.6
THICKNESS 1.0

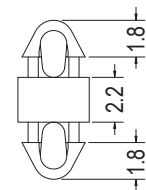

MOUNTING HOLE Ø2.6
THICKNESS 1.0

Part No.	Package
MADM1-2.2	2000

PC板間隔柱 SPACER SUPPORT

用途：PC板與PC板間之固定，不佔空間。

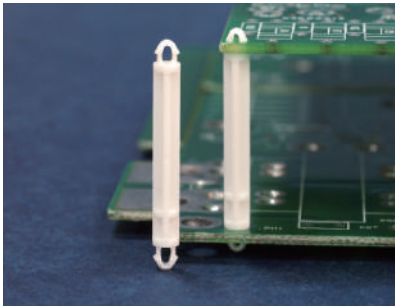

- Material: Nylon 66 (UL)
- Flame Class: 94V-2/94V-0
- Color: Natural/Black
- Unit: mm

MOUNTING HOLE Ø3.0
THICKNESS 1.2

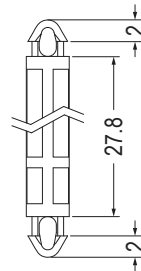

MOUNTING HOLE Ø3.0
THICKNESS 1.6

Part No.	Package
MADL-27.8	1000

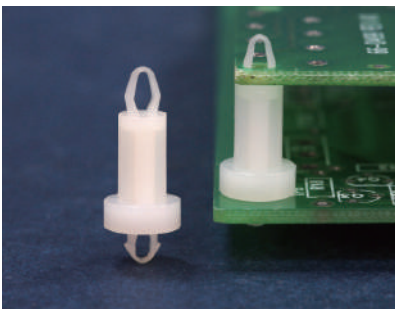

MOUNTING HOLE Ø3.0
THICKNESS 1.2

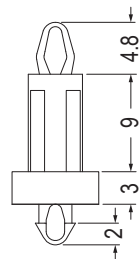

MOUNTING HOLE Ø3.0
THICKNESS 1.6

Part No.	Package
MAMDC-12	1000

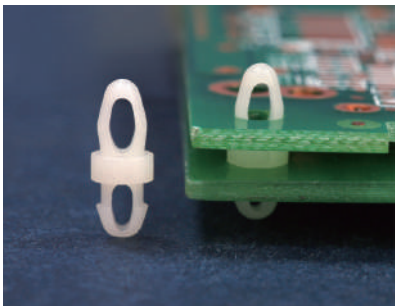

MOUNTING HOLE Ø3.1
THICKNESS 1.4~1.6

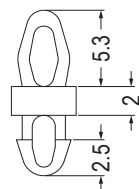

MOUNTING HOLE Ø3.0
THICKNESS 1.45~1.6

Part No.	Package
MADD-2	1000

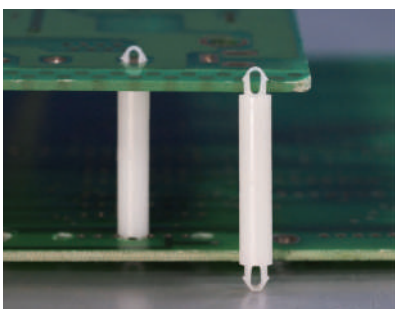

MOUNTING HOLE Ø3.2
THICKNESS 1.6

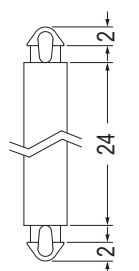

MOUNTING HOLE Ø3.2
THICKNESS 1.6

Part No.	Package
MADN-24	1000

PC板間隔柱 SPACER SUPPORT

用途：PC板與PC板間之固定，不佔空間。

1

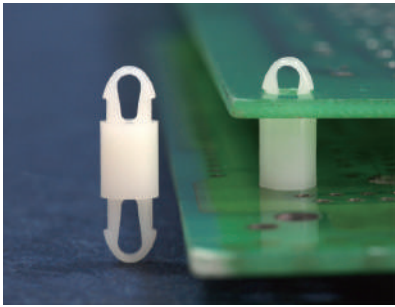

- Material: Nylon 66 (UL)
- Flame Class: 94V-2/94V-0
- Color: Natural/Black
- Unit: mm

MOUNTING HOLE $\varnothing 3.5$
THICKNESS 1.6

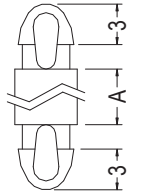

MOUNTING HOLE $\varnothing 3.5$
THICKNESS 1.6

Part No.	A	Package
MAF-2	2.0	1000
MAF-3	3.0	
MAF-4	4.0	
MAF-5	5.0	
MAF-6	6.0	
MAF-7	7.0	
MAF-8	8.0	

Part No.	A	Package
MAF-10	10.0	1000
MAF-11	11.0	
MAF-12	12.0	
MAF-14	14.0	
MAF-16	16.0	
MAF-18	18.0	
MAF-20	20.0	
MAF-22	22.0	

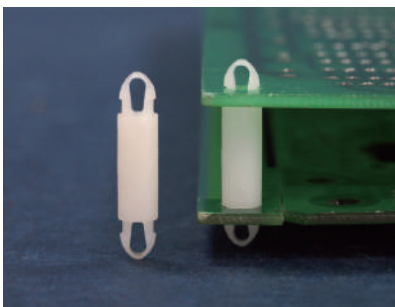

MOUNTING HOLE $\varnothing 3.5$
THICKNESS 1.6

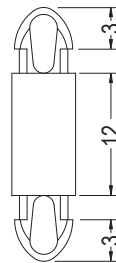

MOUNTING HOLE $\varnothing 3.5$
THICKNESS 1.6

Part No.	Package
MAD3.5-12	1000

MOUNTING HOLE $\varnothing 3.5$
THICKNESS 2.1

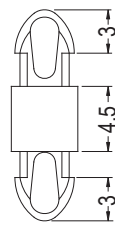

MOUNTING HOLE $\varnothing 3.5$
THICKNESS 1.6

Part No.	Package
MDLS-4.5	1000

MOUNTING HOLE $\varnothing 3.5$
THICKNESS 1.6

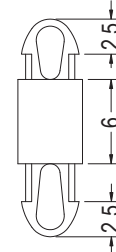

MOUNTING HOLE $\varnothing 3.5$
THICKNESS 2.5

Part No.	Package
MAFA-6	1000

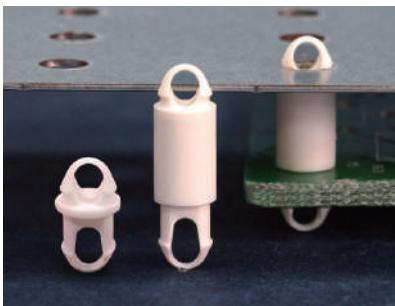

MOUNTING HOLE $\varnothing 5.0$
THICKNESS 0.8

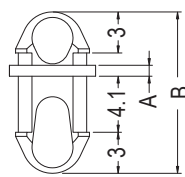

MOUNTING HOLE $\varnothing 5.0$
THICKNESS 4.0

Part No.	A	B	Package
MAFB5-0.8	0.8	11.8	500
MAFB5-9.7	9.7	20.7	

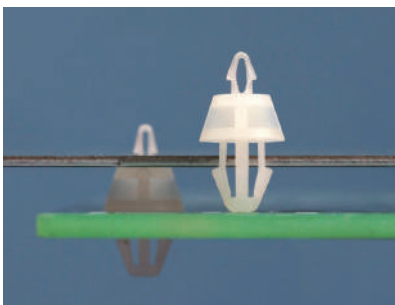

MOUNTING HOLE $\varnothing 1.5$
THICKNESS 0.8

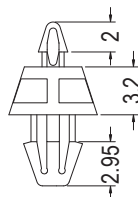

MOUNTING HOLE $\varnothing 3.0$
THICKNESS 1.6

Part No.	Package
MAEB-3.2	1000

MOUNTING HOLE $\varnothing 2.5$
THICKNESS 1.0

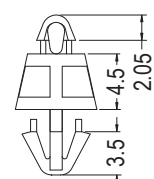

MOUNTING HOLE $\varnothing 4.0$
THICKNESS 1.6

Part No.	Package
MAEE-4.5	1000

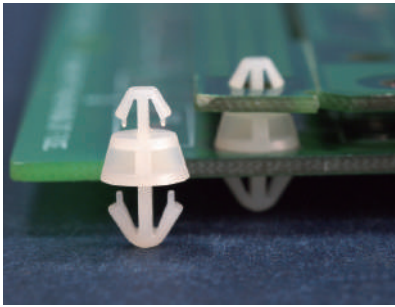

- Material: Nylon 66 (UL)
- Flame Class: 94V-2/94V-0
- Color: Natural/Black
- Unit: mm

MOUNTING HOLE Ø3.0
THICKNESS 1.0

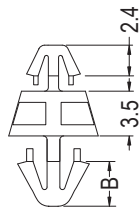

MOUNTING HOLE Ø3.0
THICKNESS 1.0

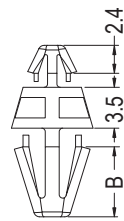

MOUNTING HOLE Ø4.0
THICKNESS: T

[MAEA-3.5M]

MOUNTING HOLE Ø4.8
THICKNESS: T

Part No.	B	T	Package
MAEA-3.5M	3.5	1.6	1000
MAEA-3.5	6.0	1.2	
MAEA-3.5L	6.0	1.6	
MAEA-3.5LS	4.1	1.6	

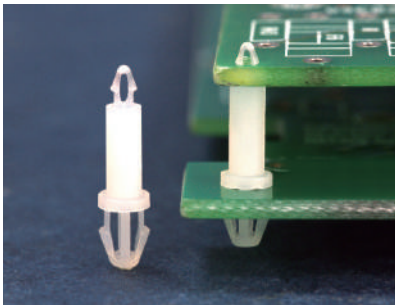

MOUNTING HOLE Ø1.5
THICKNESS 1.0

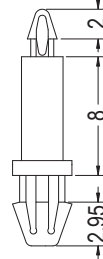

Part No.	Package
LCMB-8	1000

MOUNTING HOLE Ø3.0
THICKNESS 1.6

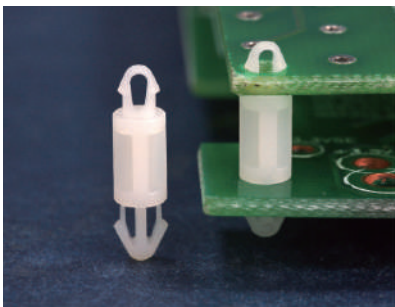

MOUNTING HOLE Ø2.5
THICKNESS 1.6

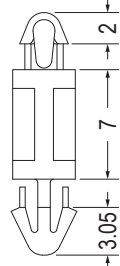

MOUNTING HOLE Ø3.0
THICKNESS 1.6

Part No.	Package
LCMC-7	1000

MOUNTING HOLE Ø3.5
THICKNESS 2.4

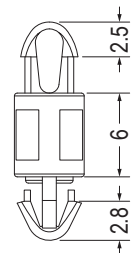

MOUNTING HOLE Ø3.5
THICKNESS 1.6

Part No.	Package
MAMDD-6	1000

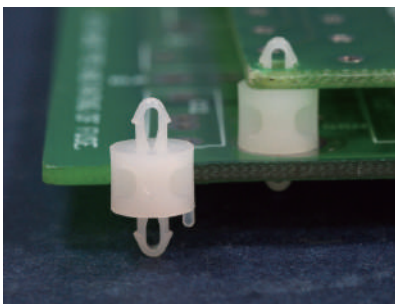

MOUNTING HOLE Ø2.5
THICKNESS 1.6

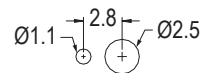
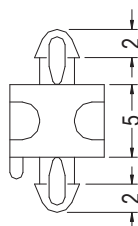

MOUNTING HOLE

MOUNTING HOLE Ø2.5
THICKNESS 1.6

Part No.	Package
MADMK-5	2000

PC板間隔柱 SPACER SUPPORT

用途：PC板與PC板間之固定，不佔空間。

1

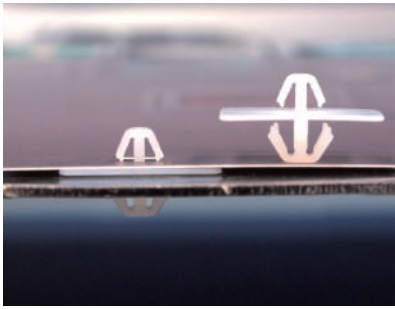

- Material: Nylon 66 (UL)
- Flame Class: 94V-2/94V-0
- Color: Natural/Black
- Unit: mm

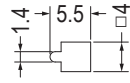

MOUNTING HOLE THICKNESS: T

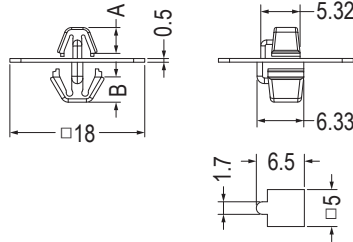

MOUNTING HOLE THICKNESS 1.0~1.5

Part No.	A	B	T	Package
KVD-05	3.5	3.4	0.5	500
KVD-10	3.6	3.5	1.0	

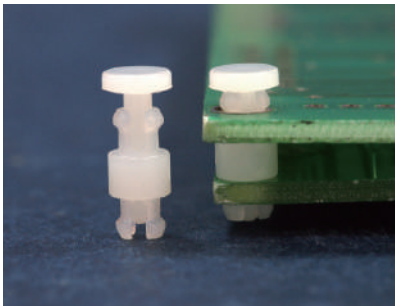

MOUNTING HOLE Ø3.0 THICKNESS 1.1

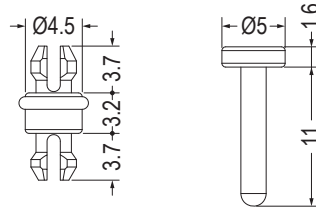

MOUNTING HOLE Ø3.0 THICKNESS 1.7~2.0

BODY

PIN

MOUNTING HOLE Ø3.0 THICKNESS 1.7

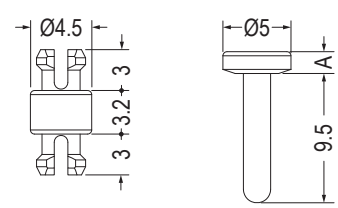

MOUNTING HOLE Ø3.0 THICKNESS 1.7

BODY

PIN

Part No.	Package
MSPC3-3.2L	1000

Part No.	A	Package
MSPC3-3.2	1.6	1000
MSPC3-3.2M	3.0	

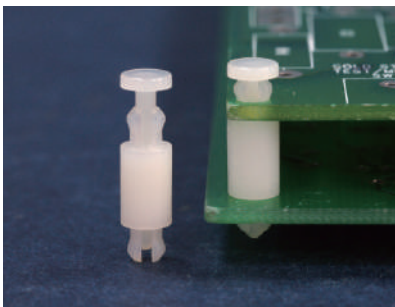

MOUNTING HOLE Ø3.0 THICKNESS 1.6

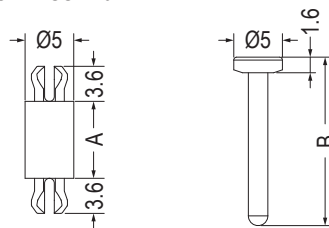

MOUNTING HOLE Ø3.0 THICKNESS 1.6

BODY

PIN

Part No.	A	B	Package
MSPF3-6.4	6.35	15.75	2000
MSPF3-8	7.9	17.3	
MSPF3-10	10.0	19.4	
MSPF3-12.7	12.7	22.1	
MSPF3-15.9	15.9	25.3	

導電PC板間隔柱 CONDUCTIVE SPACER SUPPORT

用途：快速固定PC板於機板上，上下板可導電，抗E.M.I美觀。

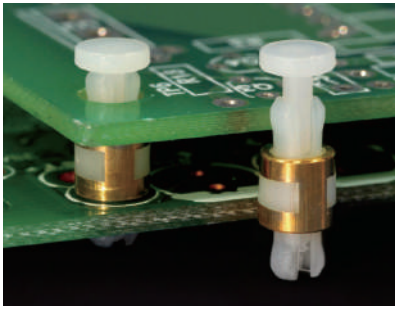

- Material: Nylon 66 (UL)
- Flame Class: 94V-2/94V-0
- Color: Natural/Black
- Unit: mm
- Patented (專利品)

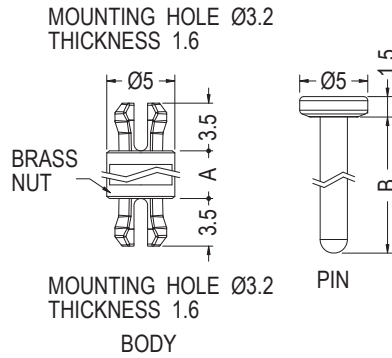

Part No.	A	B	Package
MSP-3	3.0	10.0	1000
MSP-4	4.0	11.0	
MSP-5	5.0	12.0	

PC板間隔柱 SPACER SUPPORT

用途：PC板與PC板間之固定，不佔空間。

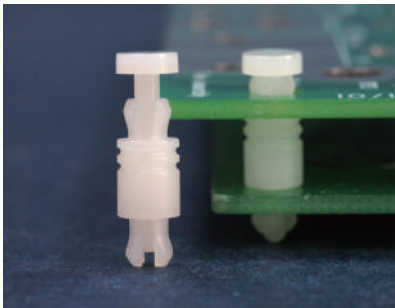

- Material: Nylon 66 (UL)
- Flame Class: 94V-2/94V-0
- Color: Natural/Black
- Unit: mm

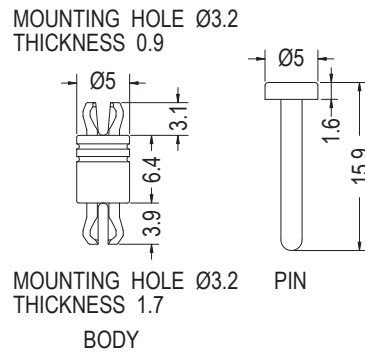

Part No.	Package
MSPB3.2-6.4	1000

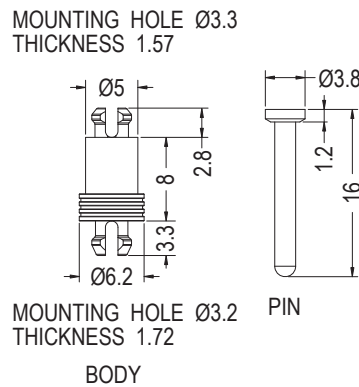
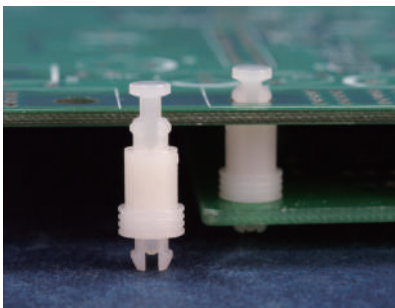

Part No.	Package
MSPB-8	1000

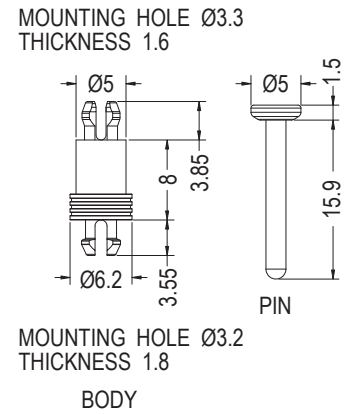

Part No.	Package
MSPB-8L	1000

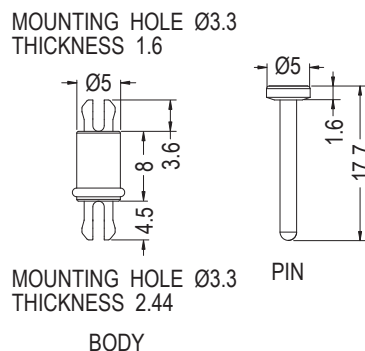
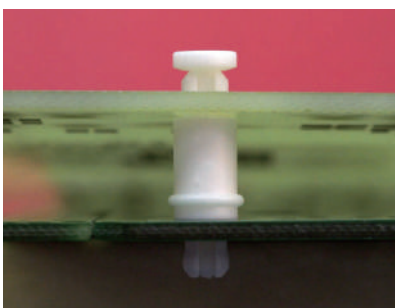

Part No.	Package
MSPF3.3-8L	1000

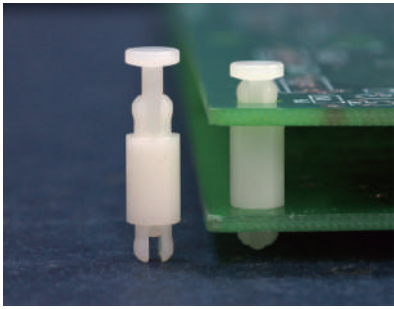

- Material: Nylon 66 (UL)
- Flame Class: 94V-2/94V-0
- Color: Natural/Black
- Unit: mm

MOUNTING HOLE Ø3.3
THICKNESS 1.6

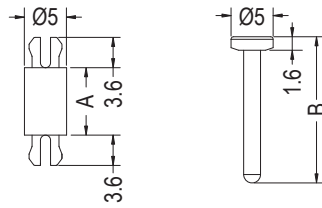

MOUNTING HOLE Ø3.3
THICKNESS 1.6

BODY

PIN

Part No.	A	B	Package
MSPF3.3-8	8.0	17.35	2000
MSPF3.3-17.5	17.5	26.3	

MOUNTING HOLE Ø3.3
THICKNESS 1.6

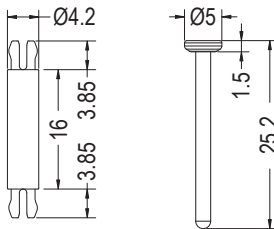

MOUNTING HOLE Ø3.3
THICKNESS 1.6

BODY

PIN

Part No.	Package
MSPCA-16	1000

MOUNTING HOLE Ø3.3
THICKNESS 2.2

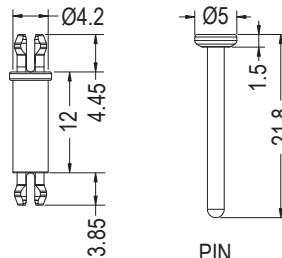

MOUNTING HOLE Ø3.3
THICKNESS 1.6

BODY

PIN

Part No.	Package
MSPCA3.3-12	1000

MOUNTING HOLE Ø3.3
THICKNESS 1.6

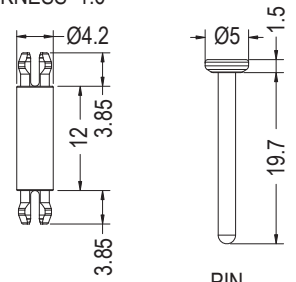

MOUNTING HOLE Ø3.3
THICKNESS 1.6

BODY

PIN

Part No.	Package
MSPCA3.3-12S	1000

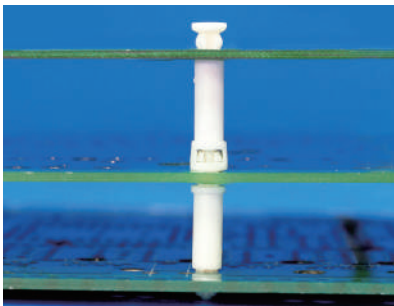

- Material: Nylon 66 (UL)
- Flame Class: 94V-2/94V-0
- Color: Natural/Black
- Unit: mm
- Patented (專利品)

MOUNTING HOLE Ø3.3
THICKNESS 2.2

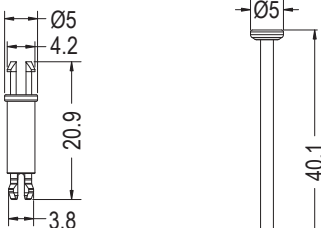

MOUNTING HOLE Ø3.3
THICKNESS 1.6

【 MSPO-1216A 】

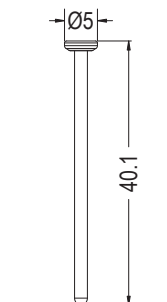

【 MSPO-1216C 】

MOUNTING HOLE Ø3.3
THICKNESS 1.6

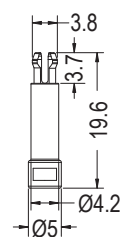

【 MSPO-1216BS 】

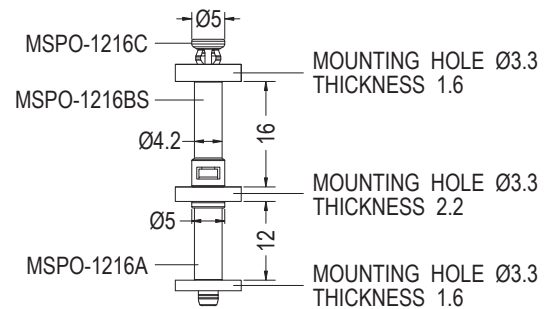

Part No.	Part No.	Package
MSPO-1216S	MSPO-1216A	1000
	MSPO-1216BS	
	MSPO-1216C	

PC板間隔柱 SPACER SUPPORT

用途：PC板與PC板間之固定，不佔空間。

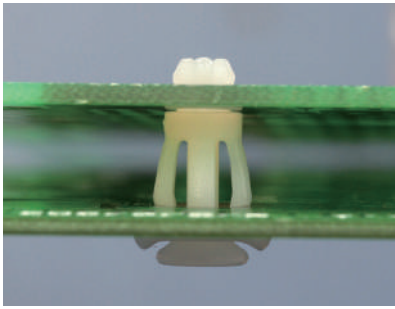

- Material: Nylon 66 (UL)
- Flame Class: 94V-2/94V-0
- Color: Natural/Black
- Unit: mm

MOUNTING HOLE $\varnothing 4.0$
THICKNESS 1.6

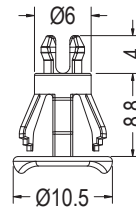

MOUNTING HOLE $\varnothing 7.0$
THICKNESS 0.8~1.6
BODY

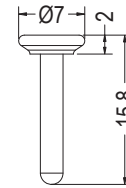

PIN

• Patented (專利品)

Part No.	Package
RCQC-7	1000

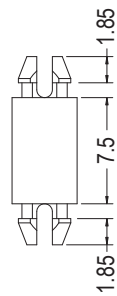
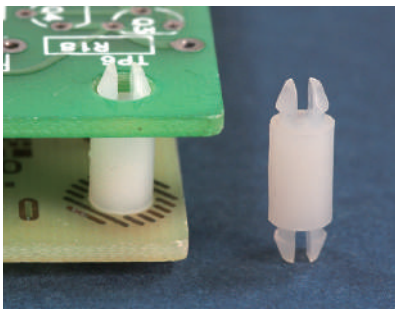

MOUNTING HOLE $\varnothing 3.2$
THICKNESS 1.0

MOUNTING HOLE $\varnothing 3.2$
THICKNESS 1.0

Part No.	Package
MSPS3S-7.5	1000

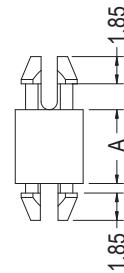

MOUNTING HOLE $\varnothing 3.2$
THICKNESS 1.6

MOUNTING HOLE $\varnothing 3.2$
THICKNESS 0.5

Part No.	A	Package
DMSB-5	5.0	1000
DMSB-8	8.0	

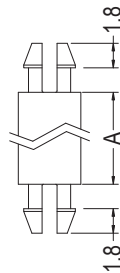
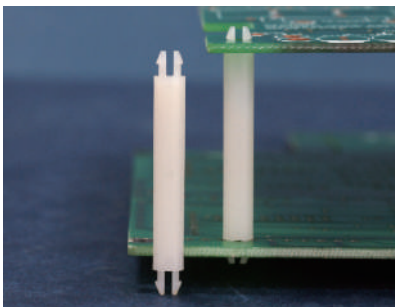

MOUNTING HOLE $\varnothing 3.2$
THICKNESS 1.6

MOUNTING HOLE $\varnothing 3.2$
THICKNESS 1.6

Part No.	A	Package
DMSS-28	28.6	1000
DMSS-38	38.1	

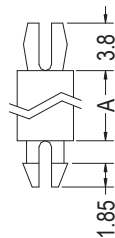
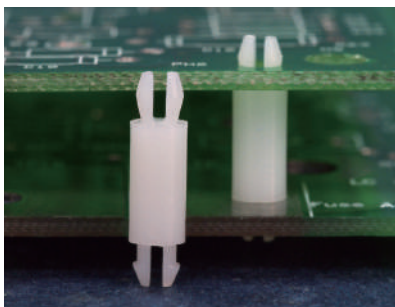

MOUNTING HOLE $\varnothing 3.2$
THICKNESS 1.6

MOUNTING HOLE $\varnothing 3.2$
THICKNESS 1.6

Part No.	A	Package
MSP3-14	14.3	1000
MSP3-15.9	15.9	
MSP3-16	16.0	
MSP3-17	17.5	
MSP3-19	19.1	
MSP3-20	20.6	
MSP3-21	21.0	
MSP3-22	22.2	
MSP3-25	25.4	
MSP3-27	27.0	
MSP3-28	28.5	
MSP3-29.2	29.2	
MSP3-31.7	31.7	
MSP3-31.8	31.8	
MSP3-34	34.9	
MSP3-38	38.1	

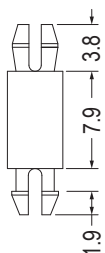

MOUNTING HOLE $\varnothing 3.2$
THICKNESS 1.73

MOUNTING HOLE $\varnothing 3.2$
THICKNESS 1.6

Part No.	Package
MSP3-8L	1000

PC板間隔柱 SPACER SUPPORT

用途：PC板與PC板間之固定，不佔空間。

1

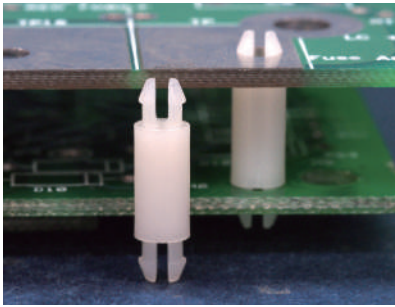

- Material: Nylon 66 (UL)
- Flame Class: 94V-2/94V-0
- Color: Natural/Black
- Unit: mm

MOUNTING HOLE Ø3.2
THICKNESS 0.8

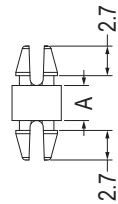

MOUNTING HOLE Ø3.2
THICKNESS 0.8

MOUNTING HOLE Ø3.2
THICKNESS 1.6

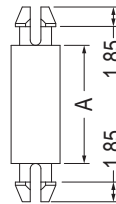

MOUNTING HOLE Ø3.2
THICKNESS 1.6

[MSPS3-3S, MSPS3-3.2S]

Part No.	A	Package
MSPS3-1.2	1.2	2000
MSPS3-3S	3.0	
MSPS3-3.2	3.2	
MSPS3-3.2S	3.2	
MSPS3-4	4.0	1000
MSPS3-4.8	4.8	
MSPS3-6.4	6.4	
MSPS3-8	7.9	
MSPS3-8.7	8.7	
MSPS3-9.5	9.5	
MSPS3-11.1	11.1	
MSPS3-12.7	12.7	
MSPS3-14.3	14.3	
MSPS3-15.9	15.9	
MSPS3-19.1	19.1	
MSPS3-20.6	20.6	
MSPS3-22.2	22.2	
MSPS3-25.4	25.4	
MSPS3-31.8	31.8	
MSPS3-34.9	34.9	

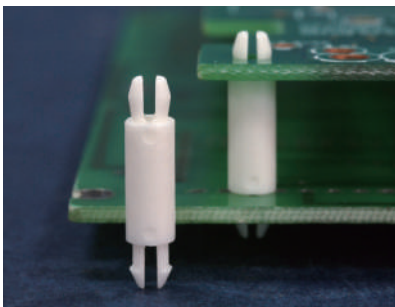

MOUNTING HOLE Ø3.2
THICKNESS 1.6

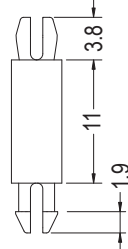

MOUNTING HOLE Ø3.2
THICKNESS 2.4

Part No.	Package
MSPL-11	1000

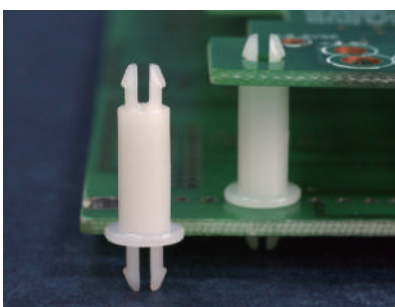

MOUNTING HOLE Ø3.2
THICKNESS 1.7

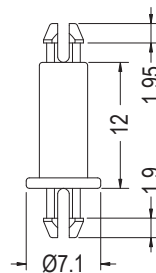

MOUNTING HOLE Ø3.2
THICKNESS 2.7

Part No.	Package
MSPMA-12	1000

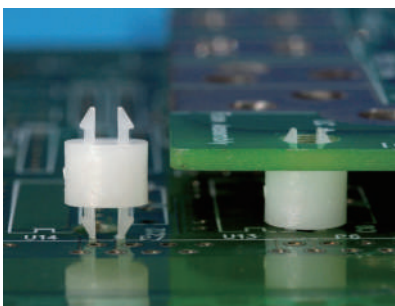

MOUNTING HOLE Ø3.3
THICKNESS 0.8

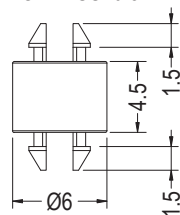

MOUNTING HOLE Ø3.3
THICKNESS 0.8

Part No.	Package
DMSC-4.5	2000

PC板間隔柱 SPACER SUPPORT

用途：PC板與PC板間之固定，不佔空間。

- Material: Nylon 66 (UL)
- Flame Class: 94V-2/94V-0
- Color: Natural/Black
- Unit: mm

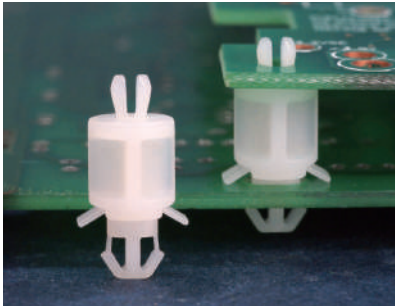
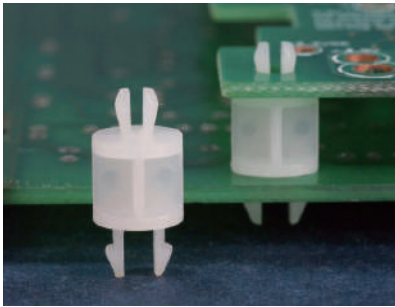

MOUNTING HOLE Ø3.3
THICKNESS 1.6

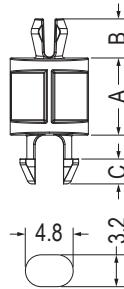

MOUNTING HOLE
THICKNESS: T

Part No.	A	B	C	T	Package
MSPD-7.9	7.9	4.1	2.6	2.16	1000
MSPD-7.9S	7.9	4.1	2.55	1.6	
MSPD-7.9L	7.9	4.1	2.55	2.34	
MSPD-12	12.0	4.1	2.55	2.16	
★MSPD-12M	12.0	4.0	2.55	2.7	
MSPD-16	16.0	4.1	2.55	2.16	

MOUNTING HOLE Ø3.3
THICKNESS 1.6

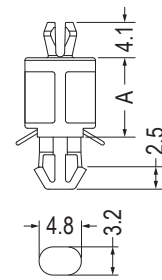

MOUNTING HOLE
THICKNESS 2.7~3.3

Part No.	A	Package
MSPN-9	9.0	1000
MSPN-12	12.0	

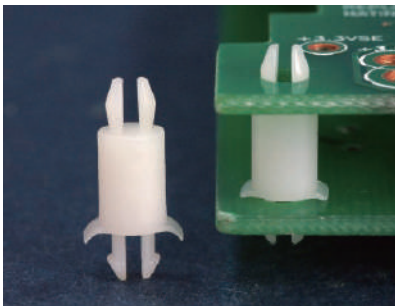

MOUNTING HOLE Ø3.3
THICKNESS 1.6~1.7

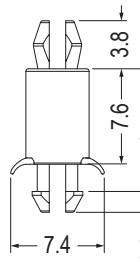

MOUNTING HOLE Ø3.2
THICKNESS 1.7~2.1

Part No.	Package
MSPH-7.5	1000

MOUNTING HOLE Ø4.3
THICKNESS 1.6~1.7

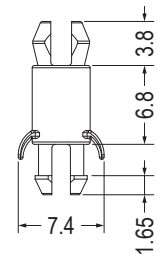

MOUNTING HOLE Ø4.0
THICKNESS 1.7~2.5

Part No.	Package
MSPH-6.8L	1000

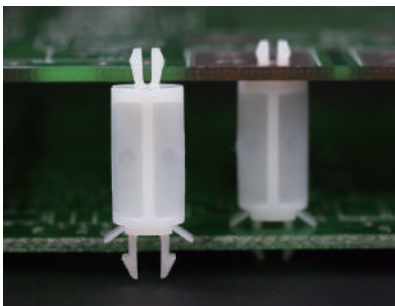

MOUNTING HOLE Ø3.3
THICKNESS 1.6

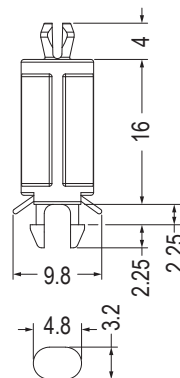

MOUNTING HOLE
THICKNESS 1.8~2.0

Part No.	Package
MSPQ-16	1000

PC板間隔柱 SPACER SUPPORT

用途：PC板與PC板間之固定，不佔空間。

1

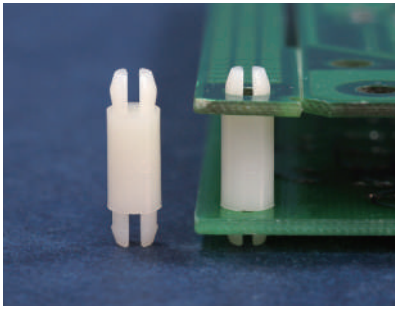

- Material: Nylon 66 (UL)
- Flame Class: 94V-2/94V-0
- Color: Natural/Black
- Unit: mm

MOUNTING HOLE $\varnothing 3.9$
THICKNESS 1.6

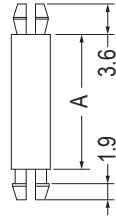

MOUNTING HOLE $\varnothing 3.9$
THICKNESS 1.6

【 MSP-15.9S 】

MOUNTING HOLE $\varnothing 4.0$
THICKNESS 1.6

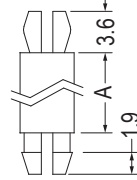

MOUNTING HOLE $\varnothing 4.0$
THICKNESS 1.6

Part No.	A	Package
MSP-3	3.2	1000
MSP-4	4.0	
MSP-4.5	4.5	
MSP-5	5.0	
MSP-6	6.3	
MSP-7	7.0	
MSP-8	8.0	
MSP-9	9.5	
MSP-10	10.5	
MSP-12	12.7	
MSP-14	14.0	
MSP-15	15.9	
MSP-15.9S	15.9	
MSP-19	19.0	
MSP-22	22.0	

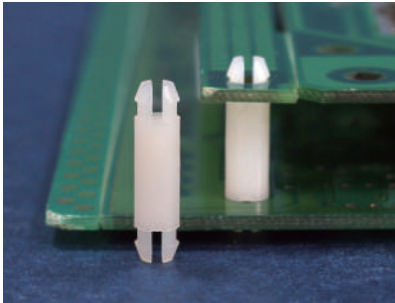

MOUNTING HOLE $\varnothing 4.0$
THICKNESS 1.6

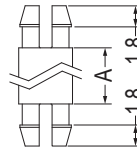

MOUNTING HOLE $\varnothing 4.0$
THICKNESS 1.6

Part No.	A	Package
DMSP-4.8	4.8	1000
DMSP-6.4	6.4	
DMSP-11.1	11.1	

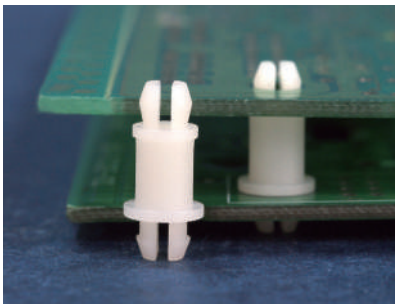

MOUNTING HOLE $\varnothing 4.0$
THICKNESS 1.6

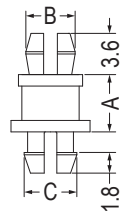

MOUNTING HOLE $\varnothing 4.0$
THICKNESS 1.6

Part No.	A	B	C	Package
DMSPS-5	5.0	4.3	4.6	1000
DMSPS-6.4	6.4	4.4	4.6	
DMSPS-7.9	7.9	4.3	4.6	
DMSPS-12.7	12.7	4.3	4.6	
DMSPS-17.5	17.5	4.3	4.6	
DMSPS-17.5S	17.5	4.2	4.25	

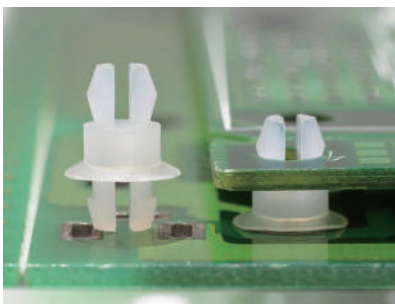

MOUNTING HOLE $\varnothing 3.9$
THICKNESS 1.6

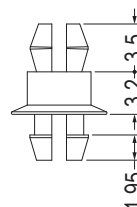

MOUNTING HOLE $\varnothing 3.9$
THICKNESS 1.6

MOUNTING HOLE $\varnothing 3.96$
THICKNESS 1.58

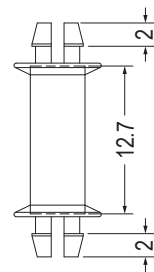

MOUNTING HOLE $\varnothing 3.96$
THICKNESS 1.58

- Color: Green



Part No.	Package
MSPV-3	1000

Part No.	Package
★MSPY-12.7	1000

PC板間隔柱 SPACER SUPPORT

用途：PC板與PC板間之固定，不佔空間。

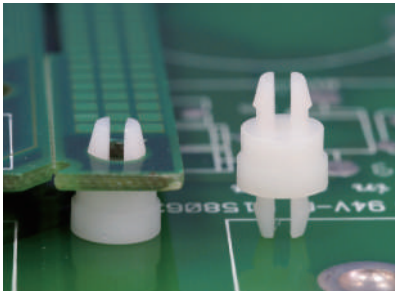

- Material: Nylon 66 (UL)
- Flame Class: 94V-2/94V-0
- Color: Natural/Black
- Unit: mm

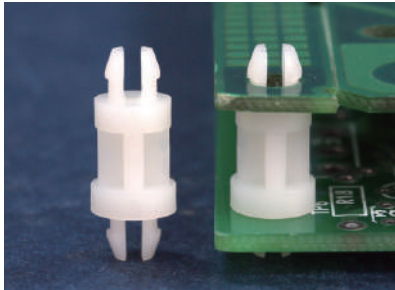

MOUNTING HOLE Ø4.0
THICKNESS 1.57

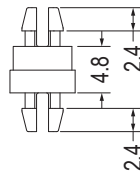

MOUNTING HOLE Ø4.0
THICKNESS 1.57

Part No.	Package
SP1-4.8	2000

MOUNTING HOLE Ø4.0
THICKNESS 1.6

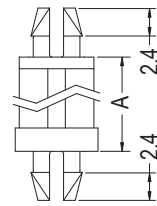

MOUNTING HOLE Ø4.0
THICKNESS 1.6

Part No.	A	Package
MSPM-5	4.8	1000
MSPM-24	23.8	

MOUNTING HOLE Ø4.0
THICKNESS 1.6

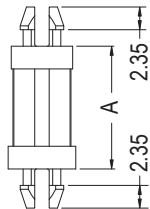

MOUNTING HOLE Ø4.0
THICKNESS 1.6

MOUNTING HOLE Ø4.0
THICKNESS 1.6

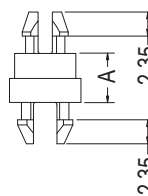

MOUNTING HOLE Ø4.8
THICKNESS 1.6

MOUNTING HOLE Ø4.0
THICKNESS 1.6

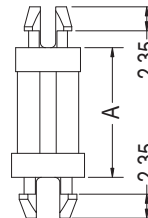

MOUNTING HOLE Ø4.8
THICKNESS 1.6

【 MSPK45-4.8 】

Part No.	A	Package
MSPK45-4.8	4.8	2000
MSPK45-6.4	6.4	
MSPK45-9.5	9.5	
MSPK45-12.7	12.7	1000
MSPK45-15.9	15.9	
MSPK45-19.1	19.1	
MSPK45-22.2	22.2	
MSPK45-25.4	25.4	

MOUNTING HOLE Ø4.8
THICKNESS 1.6

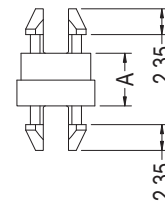

MOUNTING HOLE Ø4.8
THICKNESS 1.6

MOUNTING HOLE Ø4.8
THICKNESS 1.6

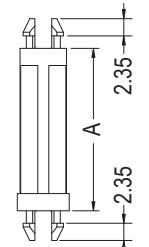

MOUNTING HOLE Ø4.8
THICKNESS 1.6

【 MSPK4.8-4.8 】

Part No.	A	Package
MSPK4.8-4.8	4.8	2000
MSPK4.8-6.4	6.4	
MSPK4.8-9.5	9.5	
MSPK4.8-12.7	12.7	1000
MSPK4.8-15.9	15.9	
MSPK4.8-19.1	19.1	
MSPK4.8-22.2	22.2	
MSPK4.8-25.4	25.4	
MSPK4.8-31.7	31.75	

Part No.	A	Package
MSP1-6.4	6.4	1000
MSP1-9.5	9.5	
MSP1-10	10.0	
MSP1-12.7	12.7	
MSP1-15.9	15.9	
MSP1-17	17.0	
MSP1-19.1	19.1	
MSP1-22.2	22.2	
MSP1-25.4	25.4	

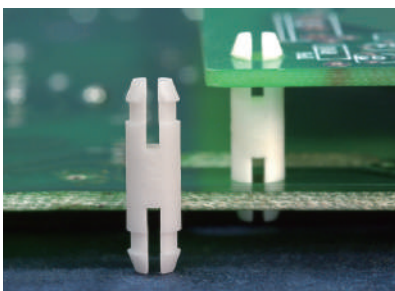
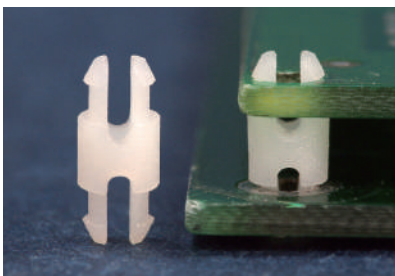

MOUNTING HOLE Ø3.0
THICKNESS 1.6

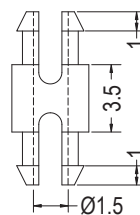

MOUNTING HOLE Ø3.0
THICKNESS 1.6

Part No.	Package
SSDU1-3.5	1000

MOUNTING HOLE Ø4.0
THICKNESS 1.6

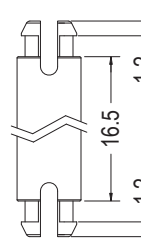

MOUNTING HOLE Ø4.0
THICKNESS 1.6

Part No.	Package
SSDUA-16.5	1000

MOUNTING HOLE Ø4.0
THICKNESS 1.6

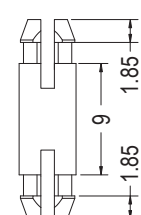

MOUNTING HOLE Ø4.0
THICKNESS 1.6

Part No.	Package
DMSA-9	1000

PC板間隔柱 SPACER SUPPORT

用途：PC板與PC板間之固定，不佔空間。

1

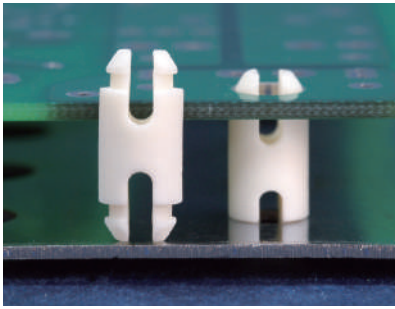

- Material: Nylon 66 (UL)
- Flame Class: 94V-2/94V-0
- Color: Natural/Black
- Unit: mm

MOUNTING HOLE Ø5.2
THICKNESS: T

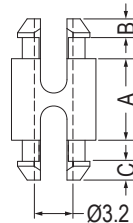

Part No.	A	B	C	T	Package
SSDU-9.2	9.2	1.55	1.55	1.6	1000
SSDU-9.6	9.6	1.85	1.85	1.2	

MOUNTING HOLE Ø5.2
THICKNESS: T

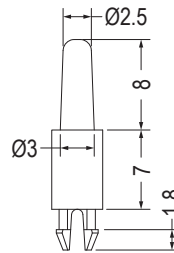
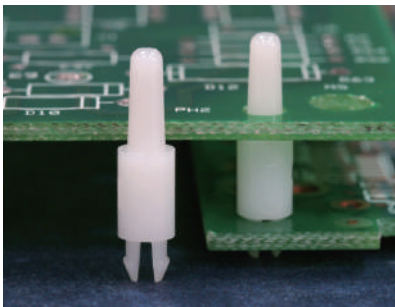

MOUNTING HOLE Ø3.2
THICKNESS 1.6

Part No.	Package
MSPE-7	1000

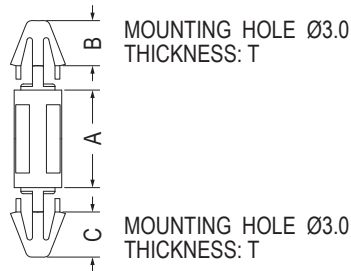
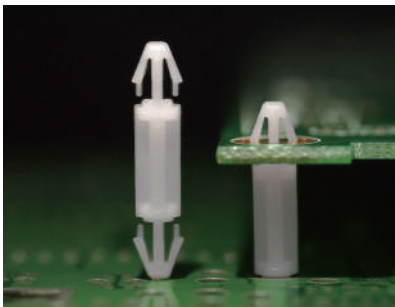

MOUNTING HOLE Ø3.0
THICKNESS: T

MOUNTING HOLE Ø3.0
THICKNESS: T

Part No.	A	B	C	T	Package
LCVU-8	8.0	3.7	3.7	1.2~1.8	1000
LCVU-9	9.0	3.55	3.55	2.0	
LCVU-10	10.0	3.7	3.7	1.2~1.8	

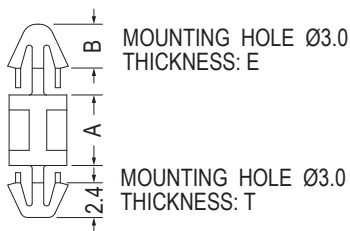

MOUNTING HOLE Ø3.0
THICKNESS: E

MOUNTING HOLE Ø3.0
THICKNESS: T

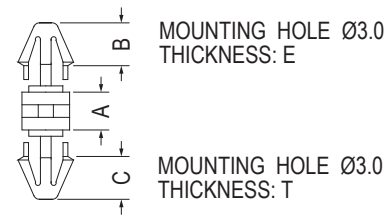

MOUNTING HOLE Ø3.0
THICKNESS: E

MOUNTING HOLE Ø3.0
THICKNESS: T

Part No.	A	B	E	T	Package
LCVA-2	2.0	3.1	1.6	0.8~1.0	2000
LCVA-2.5	2.5	3.0	0.8~1.0	1.6	
LCVA-4	4.0	3.1	1.6	0.8~1.0	
LCVA-5	5.0	3.1	1.6	0.8~1.0	

Part No.	A	B	C	E	T	Package
LCV-2.5	2.5	3.4	3.4	1.6	1.6	1000
LCV-3	3.0	3.55	3.55	1.6	1.6	
LCV-5	5.0	3.4	3.4	1.8	1.8	
LCV-6	6.0	3.6	3.6	1.2~1.7	0.8~1.0	

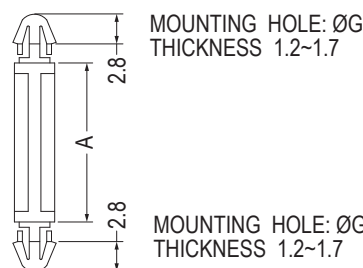
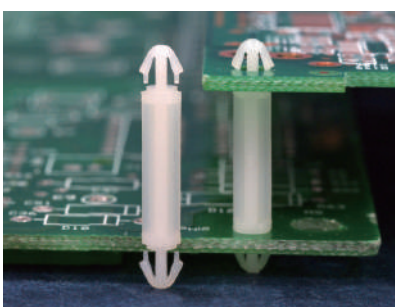

MOUNTING HOLE: ØG
THICKNESS 1.2~1.7

MOUNTING HOLE: ØG
THICKNESS 1.2~1.7

Part No.	A	G	Package
LCJ-14	14.0	3.0	1000
LCJ-15	15.0	3.2	
LCJ-19	19.0	3.0	
LCJ-21	21.0	3.0	

PC板間隔柱 SPACER SUPPORT

用途：PC板與PC板間之固定，不佔空間。

- Material: Nylon 66 (UL)
- Flame Class: 94V-2/94V-0
- Color: Natural/Black
- Unit: mm

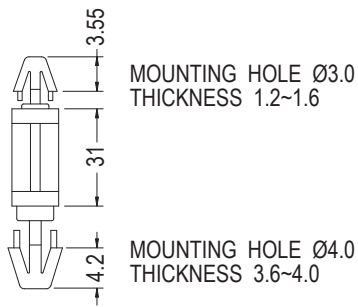
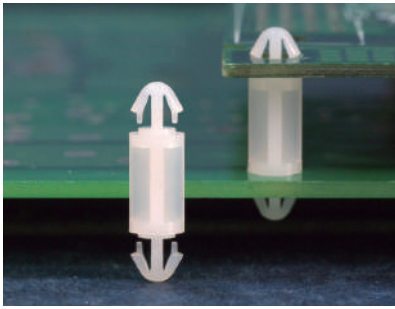

Part No.	Package
LCX-31	2000

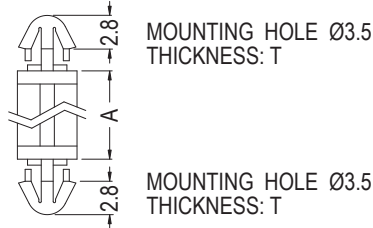

Part No.	A	T	Package
LCI-2.5	2.5	1.2~1.7	2000
LCI-3	3.0	1.2~1.7	
LCI-3.5	3.5	1.2~1.7	
LCI-4	4.0	1.2~1.7	
LCI-4.5	4.5	1.2~1.7	
LCI-5	5.0	1.2~1.7	
LCI-5.5	5.5	1.2~1.7	

Part No.	A	T	Package
LCI-6	6.0	1.2~1.7	1000
LCI-6.5	6.35	1.2~1.7	
LCI-7	7.0	1.2~1.7	
LCI-8	8.0	1.2~1.7	
LCI-9	9.0	1.2~1.7	
LCI-10	10.0	1.2~1.7	
LCI-10L	10.0	2.38	
LCI-11	11.0	1.2~1.7	
LCI-12	12.0	1.2~1.7	
LCI-15	15.0	1.2~1.7	
LCI-15(2)	15.0	1.6~2.4	
LCI-20	20.0	1.2~1.7	
LCI-22	22.0	1.2~1.7	
LCI-30L	30.0	1.6~2.4	500

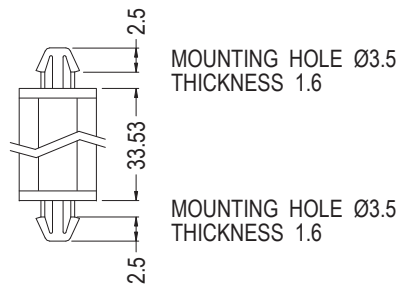
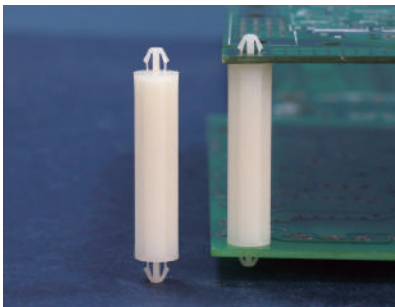

Part No.	Package
LDE-33	1000

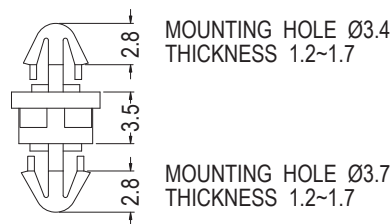
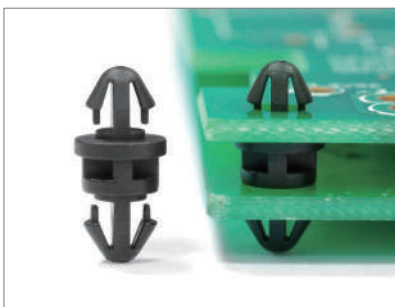

Part No.	Package
LCIA-3.5	1000

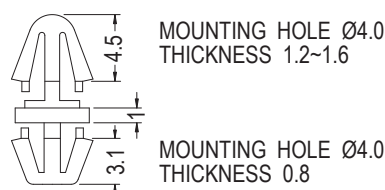
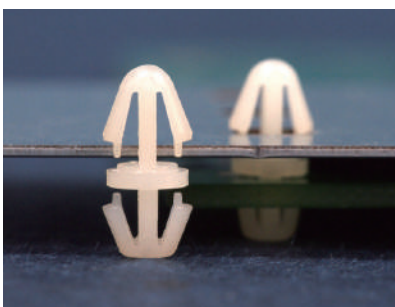

Part No.	Package
LCK-1	1000

PC板間隔柱 SPACER SUPPORT

用途：PC板與PC板間之固定，不佔空間。

1

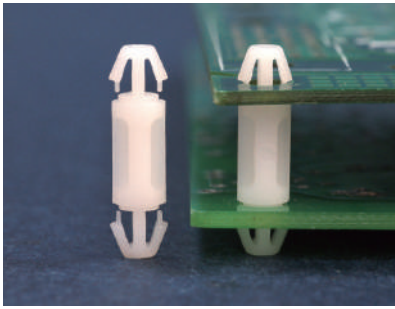

- Material: Nylon 66 (UL)
- Flame Class: 94V-2/94V-0
- Color: Natural/Black
- Unit: mm

MOUNTING HOLE $\varnothing 4.0$
THICKNESS 1.2~1.7

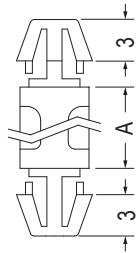

MOUNTING HOLE $\varnothing 4.0$
THICKNESS 1.2~1.7

Part No.	A	Package
LCC-3S	3.0	2000
LCC-3	3.5	
LCC-4	4.0	
LCC-5	5.0	
LCC-6S	6.0	
LCC-6	6.4	
LCC-7	7.0	
LCC-8	8.0	1000
LCC-9.5	9.5	
LCC-10S	10.0	
LCC-10	10.5	
LCC-11.5	11.5	
LCC-12S	12.0	

Part No.	A	Package
LCC-12	12.7	1000
LCC-14	14.0	
LCC-15	15.9	
LCC-18	18.0	
LCC-19	19.0	
LCC-20	20.0	
LCC-25	25.0	
LCC-25.4	25.4	
LCC-27	27.0	
LCC-30	30.0	
LCC-34	34.0	500
LCC-40	40.0	
LCC-45	45.0	
LCC-55	55.0	
LCC-69	69.0	
LCC-71	71.2	
LCC-72	72.0	
LCC-74	74.2	
LCC-80	80.0	

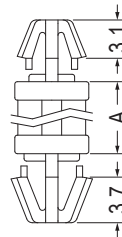
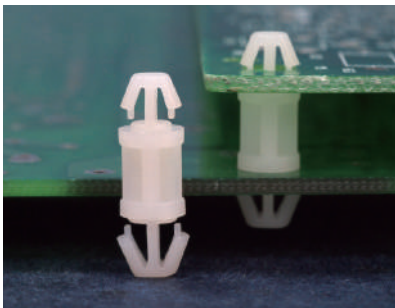

MOUNTING HOLE $\varnothing 4.0$
THICKNESS 1.6

MOUNTING HOLE $\varnothing 4.8$
THICKNESS 1.6

Part No.	A	Package
LCBM-3	3.0	1000
LCBM-4	4.0	
LCBM-6	6.0	
LCBM-8	8.0	
LCBM-10	10.0	
LCBM-12	12.0	
LCBM-14	14.0	
LCBM-16	16.0	
LCBM-18	18.0	

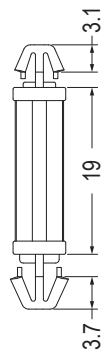

MOUNTING HOLE $\varnothing 4.0$
THICKNESS 1.6

MOUNTING HOLE $\varnothing 4.8$
THICKNESS 2.4

Part No.	Package
LCBM-19L	1000

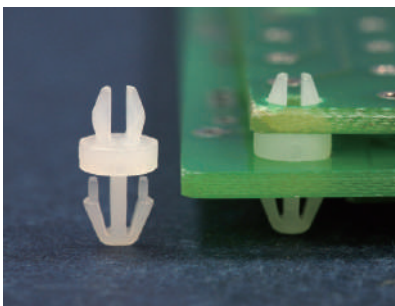

MOUNTING HOLE $\varnothing 2.6$
THICKNESS 1.0

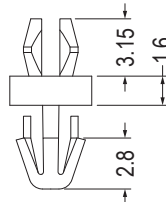

MOUNTING HOLE $\varnothing 2.8$
THICKNESS 1.6

Part No.	Package
MSPA-1.6	2000

MOUNTING HOLE $\varnothing 2.8$
THICKNESS 1.6

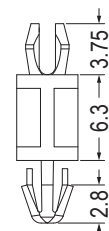

MOUNTING HOLE $\varnothing 2.8$
THICKNESS 1.6

Part No.	Package
MSPA-6.3L	1000

PC板間隔柱 SPACER SUPPORT

用途：PC板與PC板間之固定，不佔空間。

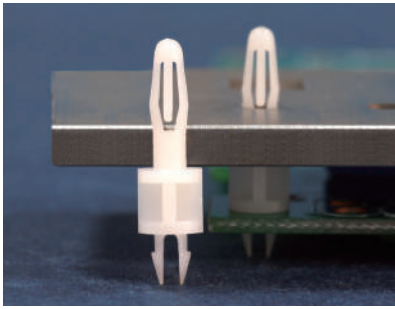

- Material: Nylon 66 (UL)
- Flame Class: 94V-2/94V-0
- Color: Natural/Black
- Unit: mm

MOUNTING HOLE Ø3.0
THICKNESS 4.0

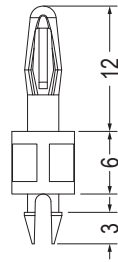

MOUNTING HOLE Ø3.0
THICKNESS 1.6

Part No.	Package
LMSA-6	1000

MOUNTING HOLE Ø3.2
THICKNESS 1.6

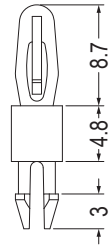

MOUNTING HOLE Ø3.2
THICKNESS 2.6

Part No.	Package
★LMSE-4.8	1000



- Material: Nylon 66 (UL)
- Flame Class: 94V-2/94V-0
- Color: Natural/Black
- Unit: mm

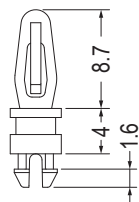

MOUNTING HOLE Ø3.2
THICKNESS 1.6

MOUNTING HOLE Ø3.2
THICKNESS 1.0~1.2

Part No.	Package
LMSB-4	1000

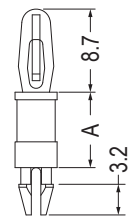
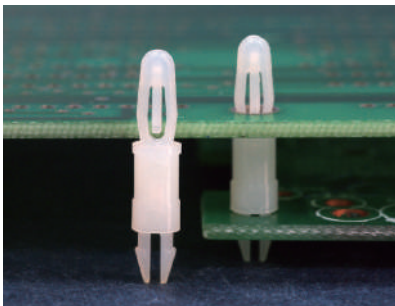

MOUNTING HOLE Ø3.2
THICKNESS 1.6~1.8

MOUNTING HOLE Ø3.2
THICKNESS 1.6

Part No.	A	Package
LMSP-8	7.9	1000
LMSP-9.5	9.5	
LMSP-16	15.9	

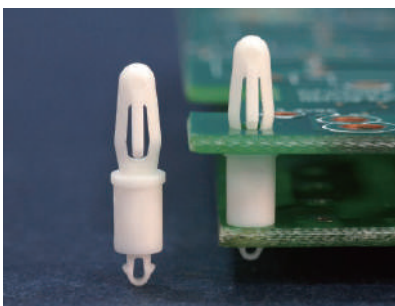

- Material: Nylon 66 (UL)
- Flame Class: 94V-2/94V-0
- Color: Natural/Black
- Unit: mm

MOUNTING HOLE Ø3.2
THICKNESS 1.6~1.7

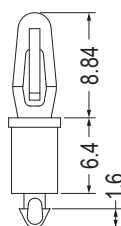

MOUNTING HOLE Ø2.0
THICKNESS 1.0~1.2

Part No.	Package
LCPL-6.4	1000

MOUNTING HOLE Ø3.5
THICKNESS 1.6

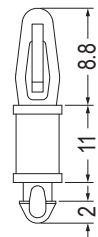

MOUNTING HOLE Ø2.6
THICKNESS 1.6

Part No.	Package
LCPLB-11	1000

PC板間隔柱 SPACER SUPPORT

用途：PC板與PC板間之固定，不佔空間。

1

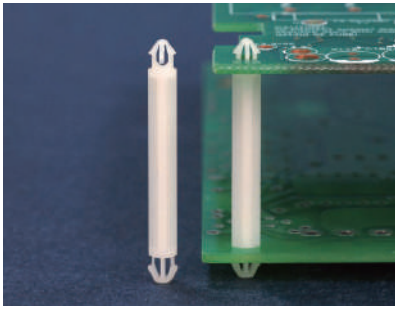

- Material: Nylon 66 (UL)
- Flame Class: 94V-2/94V-0
- Color: Natural/Black
- Unit: mm

MOUNTING HOLE Ø3.3
THICKNESS 1.6~2.1

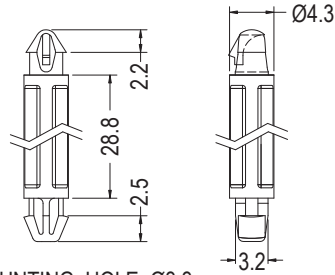

MOUNTING HOLE Ø3.3
THICKNESS 1.6

Part No.	Package
LCOA-28.8	1000

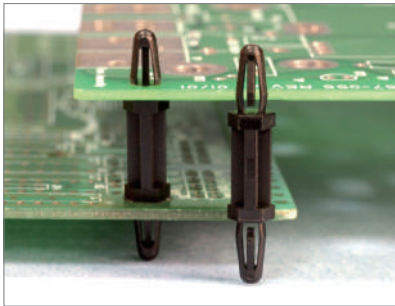

- Material: Nylon 66 (UL)
- Flame Class: 94V-2/94V-0
- Color: Natural/Black
- Unit: mm

MOUNTING HOLE Ø4.0
THICKNESS 1.6



MOUNTING HOLE Ø4.0
THICKNESS 1.6

Part No.	Package
LCSF-15	1000

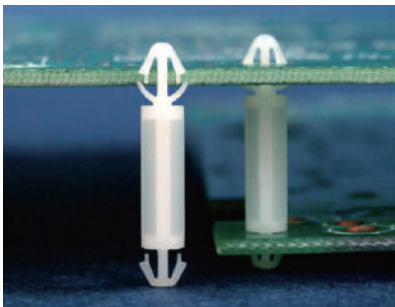

- Material: Nylon 66 (UL)
- Flame Class: 94V-2/94V-0
- Color: Natural/Black
- Unit: mm

MOUNTING HOLE Ø3.0
THICKNESS 1.6

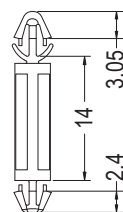

MOUNTING HOLE Ø3.0
THICKNESS: T

Part No.	T	Package
LCGA-14	0.8~1.0	1000
LCGA-14S	0.6	

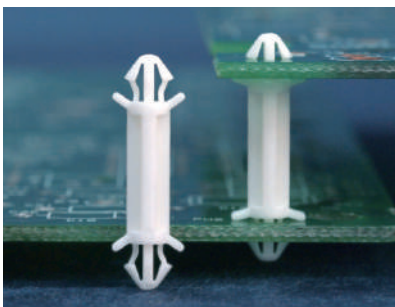

- Material: Nylon 66 (UL)
- Flame Class: 94V-2/94V-0
- Color: Natural/Black
- Unit: mm

MOUNTING HOLE Ø3.0
THICKNESS 1.2~1.6

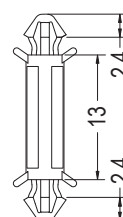

MOUNTING HOLE Ø3.0
THICKNESS 1.2~1.6

Part No.	Package
CBSA-13	1000

PC板間隔柱 SPACER SUPPORT

用途：PC板與PC板間之固定，不佔空間。

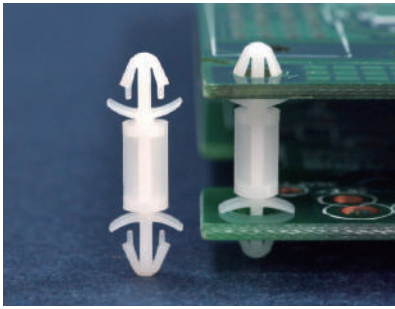

- Material: Nylon 66 (UL)
- Flame Class: 94V-2/94V-0
- Color: Natural/Black
- Unit: mm

MOUNTING HOLE Ø3.0
THICKNESS 1.2~2.0

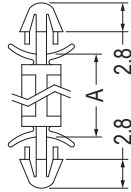

MOUNTING HOLE Ø3.0
THICKNESS 1.2~2.0

Part No.	A	Package
LCF-3	3.2	1000
LCF-4	4.0	
LCF-5	5.0	
LCF-6S	6.0	
LCF-6	6.35	
LCF-7	7.0	
LCF-8	8.0	
LCF-9	9.5	
LCF-10.6	10.6	

Part No.	A	Package
LCF-11	11.2	1000
LCF-12	12.0	
LCF-14.4	14.4	
LCF-15	15.0	
LCF-16	16.0	
LCF-17	17.0	
LCF-20	20.2	
LCF-22	22.0	
LCF-25	25.4	

MOUNTING HOLE Ø3.0
THICKNESS 1.2~2.0

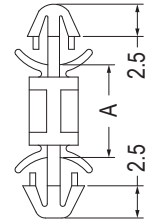

MOUNTING HOLE Ø3.5
THICKNESS 1.6~2.0

Part No.	A	Package
LCFO-3	3.0	1000
LCFO-3.5	3.5	
LCFO-4	4.0	
LCFO-4.8	4.8	
LCFO-6	6.0	
LCFO-6.4	6.4	
LCFO-7	7.0	
LCFO-8	8.0	
LCFO-9	9.0	
LCFO-10	10.0	
LCFO-11.5	11.5	
LCFO-12.7	12.7	
LCFO-14	14.0	
LCFO-16	16.0	

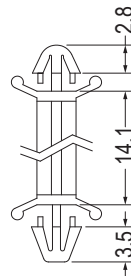
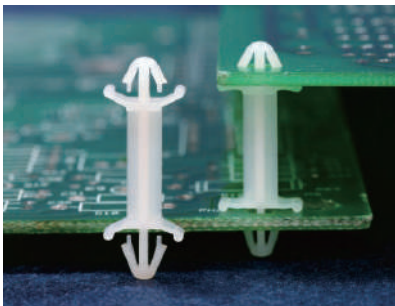

MOUNTING HOLE Ø3.5
THICKNESS 1.0

MOUNTING HOLE Ø3.5
THICKNESS 1.6

Part No.	Package
CBCS-14	1000

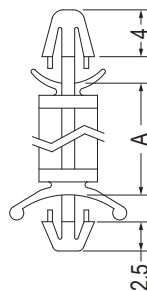
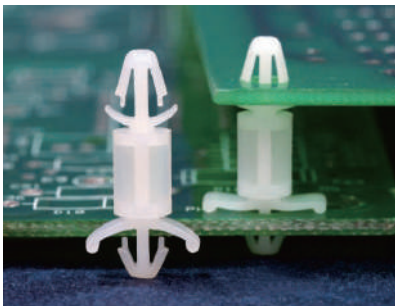

MOUNTING HOLE Ø3.5
THICKNESS 1.6

MOUNTING HOLE Ø3.5
THICKNESS 0.8~2.0

Part No.	A	Package
LCD-3	3.2	2000
LCD-4	4.0	
LCD-5	4.8	1000
LCD-6	6.4	
LCD-7	7.0	
LCD-8	8.0	
LCD-9	9.6	
LCD-11	11.2	
LCD-12	12.7	
LCD-14	14.0	
LCD-16	16.0	
LCD-18	18.0	
LCD-19	19.1	
LCD-27	27.5	

PC板間隔柱 SPACER SUPPORT

用途：PC板與PC板間之固定，不佔空間。

1

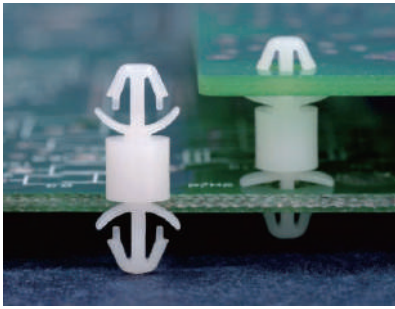

- Material: Nylon 66 (UL)
- Flame Class: 94V-2/94V-0
- Color: Natural/Black
- Unit: mm

MOUNTING HOLE Ø3.5
THICKNESS 1.6~2.0

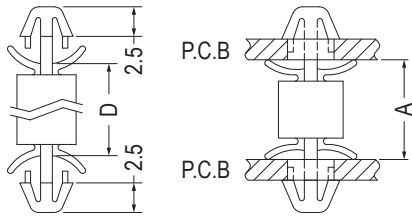

MOUNTING HOLE Ø3.5
THICKNESS 1.6~2.0

Part No.	A	D	Package
LCO-5	5.0	3.6	1000
LCO-6.4	6.4	5.0	
LCO-8	8.0	4.7	

MOUNTING HOLE Ø3.5
THICKNESS 1.6~2.0

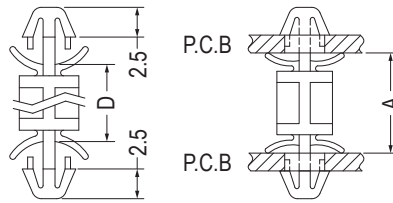

MOUNTING HOLE Ø3.5
THICKNESS 1.6~2.0

Part No.	A	D	Package
LCO-10	10.0	8.6	1000
LCO-11	11.0	9.6	
LCO-12.7	12.7	11.3	
LCO-15.9	15.9	14.5	

MOUNTING HOLE Ø3.5
THICKNESS 2.0~2.5

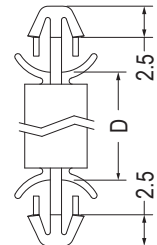

MOUNTING HOLE Ø3.5
THICKNESS 2.0~2.5



Part No.	D	Package
LCO-10L	10.1	1000
LCO-10.5L	10.5	

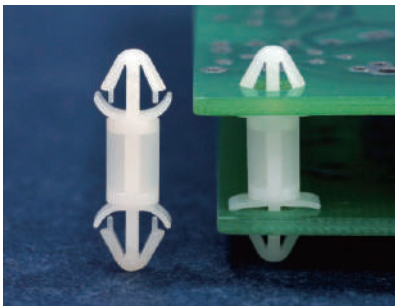

MOUNTING HOLE Ø4.0
THICKNESS 1.6

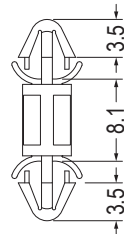

MOUNTING HOLE Ø4.0
THICKNESS 1.6

Part No.	Package
LCFB-8	1000

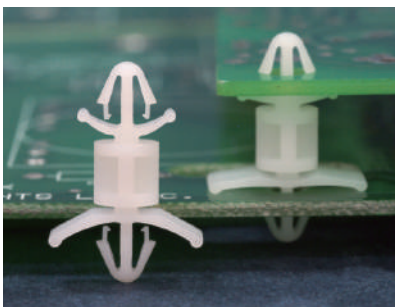

MOUNTING HOLE Ø4.0
THICKNESS 1.6

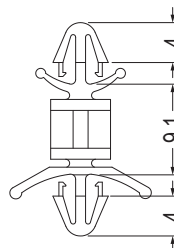

MOUNTING HOLE Ø4.0
THICKNESS 1.6

Part No.	Package
LCBJ-9	1000

MOUNTING HOLE Ø4.0
THICKNESS 0.8~1.7

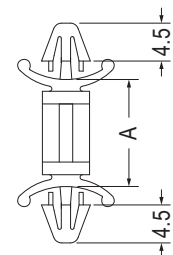

MOUNTING HOLE Ø4.0
THICKNESS 0.8~1.7

Part No.	A	Package
LCTA-4.8	4.8	2000
LCTA-12.7	12.7	1000

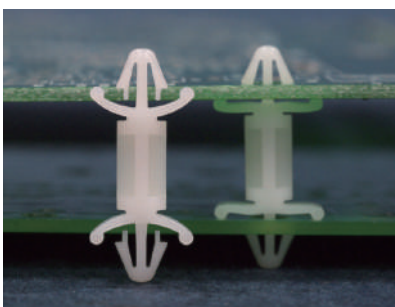

PC板間隔柱 SPACER SUPPORT

用途：PC板與PC板間之固定，不佔空間。

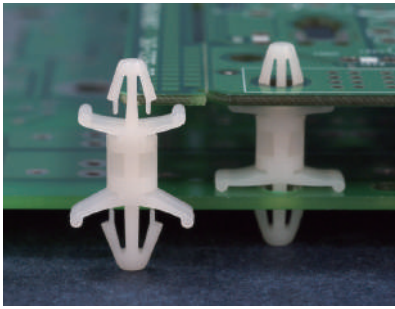

- Material: Nylon 66 (UL)
- Flame Class: 94V-2/94V-0
- Color: Natural/Black
- Unit: mm

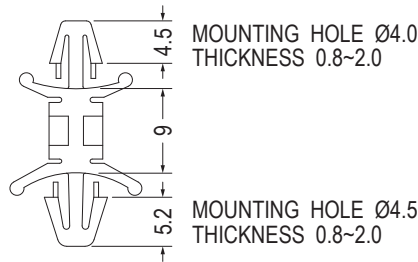

Part No.	Package
LCT-9	1000

MOUNTING HOLE Ø4.0
THICKNESS 1.0

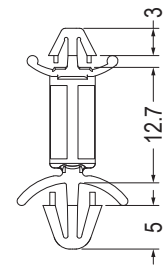

MOUNTING HOLE Ø4.8
THICKNESS 1.6

Part No.	Package
LCBD-12.7	1000

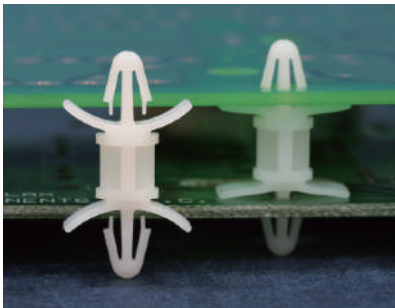

MOUNTING HOLE Ø4.0
THICKNESS: T

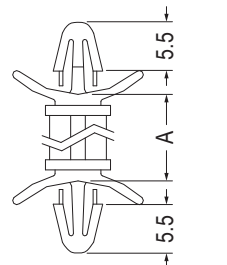

MOUNTING HOLE Ø4.0
THICKNESS: T

Part No.	A	T	Package
LCEO-5	4.8	0.8~2.0	1000
LCEO-6	6.4	0.8~2.0	
LCEO-8	7.9	0.8~2.0	
LCEO-9	9.5	0.8~2.0	
LCEO-12	12.7	0.8~2.0	
LCEO-12L	11.9	1.2~2.3	
LCEO-15	15.9	0.8~2.0	
LCEO-19	19.0	0.8~2.0	
LCEO-22	22.2	0.8~2.0	

MOUNTING HOLE Ø4.0
THICKNESS 1.6~2.0

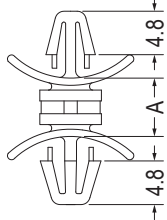

MOUNTING HOLE Ø4.8
THICKNESS 0.8~2.0

Part No.	A	Package
LCBZ-4.8	4.8	1000
LCBZ-6.4	6.4	

MOUNTING HOLE Ø4.8
THICKNESS 0.8~2.0

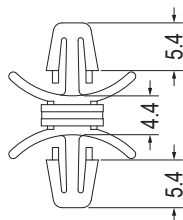

MOUNTING HOLE Ø4.8
THICKNESS 0.8~2.0

Part No.	Package
LCBYR-4.8	1000

MOUNTING HOLE Ø4.8
THICKNESS 0.8~2.0

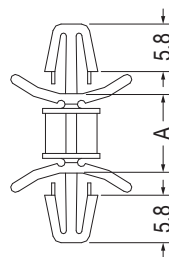

MOUNTING HOLE Ø4.8
THICKNESS 0.8~2.0

Part No.	A	Package
LCBY-4.8	4.8	1000
LCBY-6.4	6.4	
LCBY-9.5	9.5	
LCBY-12.7	12.7	
LCBY-15.9	15.9	
LCBY-19.1	19.1	
LCBY-22.2	22.2	

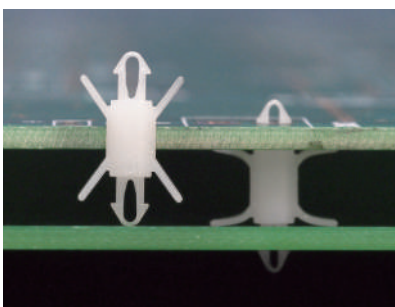

MOUNTING HOLE Ø2.0
THICKNESS 0.8~1.6

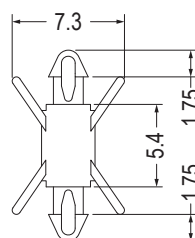

MOUNTING HOLE Ø2.0
THICKNESS 0.8~1.6

Part No.	Package
MADG-5.4	2000

PC板間隔柱 SPACER SUPPORT

用途：PC板與PC板間之固定，不佔空間。

1

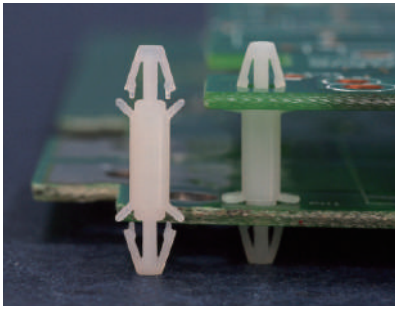

- Material: Nylon 66 (UL)
- Flame Class: 94V-2/94V-0
- Color: Natural/Black
- Unit: mm

MOUNTING HOLE Ø3.0
THICKNESS 1.6

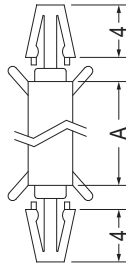

MOUNTING HOLE Ø3.0
THICKNESS 1.6

Part No.	A	Package
LCA-6	6.3	1000
LCA-8	8.0	
LCA-10	10.0	
LCA-11	11.0	
LCA-12	12.7	

MOUNTING HOLE Ø3.0
THICKNESS 0.8~2.0

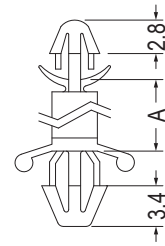

MOUNTING HOLE Ø4.0
THICKNESS 1.2~2.6

Part No.	A	Package
LCH-3	3.5	1000
LCH-4	4.0	
LCH-5	5.0	
LCH-6	6.3	
LCH-7	7.4	
LCH-8	8.5	
LCH-10	10.0	
LCH-11	11.0	
LCH-12	12.7	
LCH-15	15.9	

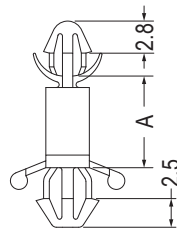
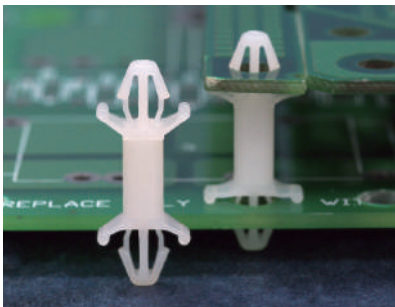
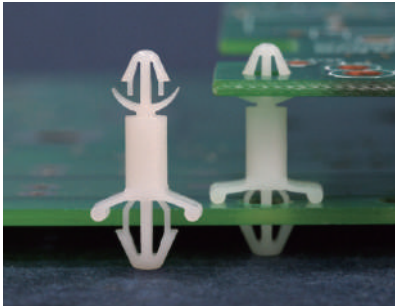

MOUNTING HOLE Ø3.0
THICKNESS 0.7~1.6

MOUNTING HOLE Ø4.0
THICKNESS 0.8~2.5

Part No.	A	Package
LCH-8S	8.0	1000
LCH-10S	10.0	
LCH-15S	13.0	

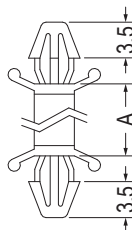

MOUNTING HOLE Ø3.5
THICKNESS 0.8~2.0

MOUNTING HOLE Ø3.5
THICKNESS 0.8~2.0

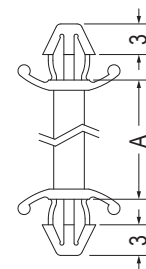

MOUNTING HOLE Ø4.0
THICKNESS 1.6

MOUNTING HOLE Ø4.0
THICKNESS 1.6

MOUNTING HOLE Ø3.5
THICKNESS 0.8~2.0

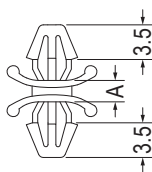

MOUNTING HOLE Ø3.5
THICKNESS 0.8~2.0

【 CBSS-2S 】

Part No.	A	Package
CBSS-2	2.1	2000
CBSS-2S	2.1	
CBSS-2.2	2.2	
CBSS-4.8	4.8	
CBSS-7	7.0	
CBSS-10	10.0	
CBSS-12.7	12.7	
CBSS-14	14.0	
CBSS-17	17.0	

Part No.	A	Package
CBLSS-6	4.2	1000
CBLSS-8	6.2	
CBLSS-10	8.2	
CBLSS-12	10.2	
CBLSS-13	11.2	
CBLSS-14	12.2	
CBLSS-16	14.2	
CBLSS-16.8	15.0	
CBLSS-18	16.2	
CBLSS-20	18.2	
CBLSS-42	40.2	

PC板間隔柱 SPACER SUPPORT

用途：固定PC板於機板上，免工具易拆卸。

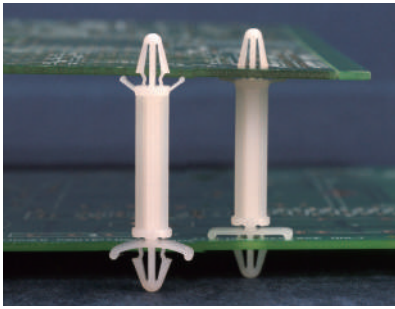

- Material: Nylon 66 (UL)
- Flame Class: 94V-2/94V-0
- Color: Natural/Black
- Unit: mm

MOUNTING HOLE Ø4.0
THICKNESS 0.8~1.7

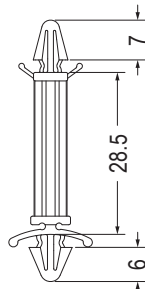

MOUNTING HOLE Ø4.8
THICKNESS 0.8~1.7

Part No.	Package
LCBSA-28.5	500

MOUNTING HOLE Ø4.0
THICKNESS 0.8~1.7

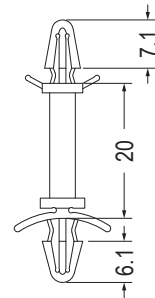

MOUNTING HOLE Ø4.8
THICKNESS 1.8~2.7

Part No.	Package
LCBSA-20L	500

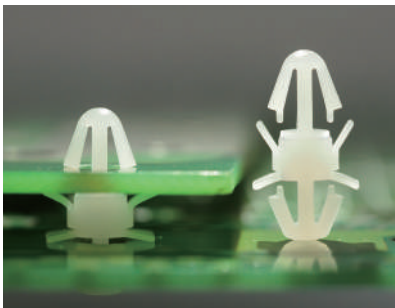

- Material: Nylon 66 (UL)
- Flame Class: 94V-2/94V-0
- Color: Natural/Black
- Unit: mm

用途：PC板與PC板間之固定，不佔空間。

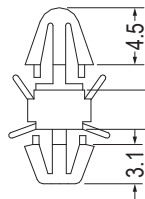

MOUNTING HOLE Ø4.0
THICKNESS 1.6

MOUNTING HOLE Ø4.0
THICKNESS 0.8

Part No.	Package
LCL-3.2	2000

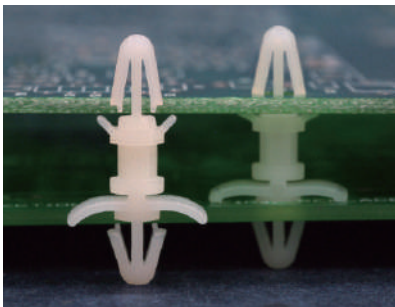

- Material: Nylon 66 (UL)
- Flame Class: 94V-2/94V-0
- Color: Natural/Black
- Unit: mm

用途：固定PC板於機板上，免工具易拆卸。

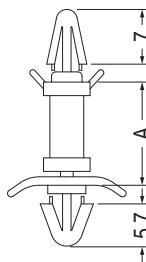

MOUNTING HOLE Ø4.0
THICKNESS 1.6

MOUNTING HOLE Ø4.8
THICKNESS 0.8~2.0

Part No.	A	Package
LCB-5	5.0	1000
LCB-6	6.3	
LCB-8	8.0	
LCB-10	10.0	
LCB-12	12.7	
LCB-15	15.9	
LCB-20	20.0	
LCB-25	25.0	

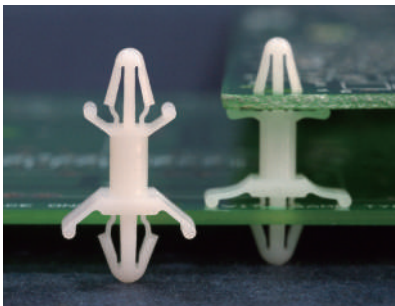

MOUNTING HOLE Ø4.0
THICKNESS 1.6

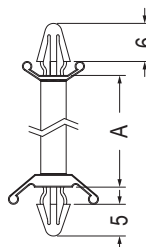

MOUNTING HOLE Ø4.0
THICKNESS 0.8~2.2

MOUNTING HOLE Ø4.0
THICKNESS 1.6

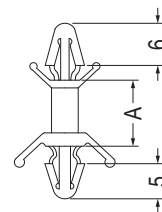

MOUNTING HOLE Ø4.8
THICKNESS 0.8~2.2

【CBSB-45】

Part No.	A	Package
CBS-3.8	3.8	1000
CBS-5	4.6	
CBS-6	6.3	
CBS-8	7.93	
CBS-9	9.2	
CBS-12	12.5	
CBS-15	15.7	
CBS-19	19.0	
CBS-22	22.0	
CBS-25	25.4	
CBS-28	28.6	
CBSB-45	45.0	

PC板間隔柱 SPACER SUPPORT

用途：固定PC板於機板上，免工具易拆卸。

1

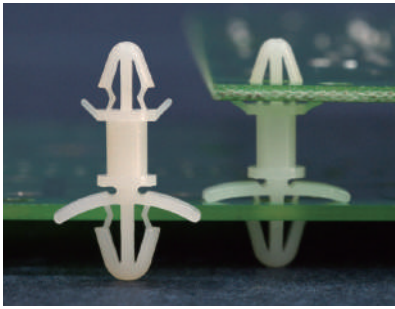

- Material: Nylon 66 (UL)
- Flame Class: 94V-2/94V-0
- Color: Natural/Black
- Unit: mm

MOUNTING HOLE $\varnothing 4.0$
THICKNESS 1.6

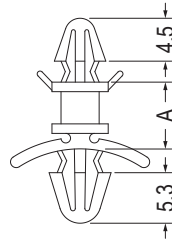

MOUNTING HOLE $\varnothing 4.8$
THICKNESS 0.8-2.2

Part No.	A	Package
LCBS-4	4.0	1000
LCBS-5	5.0	
LCBS-6	6.35	
LCBS-7	7.0	
LCBS-9	9.2	
LCBS-10	10.0	
LCBS-12	12.5	
LCBS-15	15.7	
LCBS-19	19.0	500
LCBS-20	20.0	
LCBS-22	22.0	
LCBS-25	25.4	
LCBS-28	28.6	
LCBS-30	30.0	
LCBS-35	35.0	
LCBS-38	38.0	
LCBS-45	45.0	

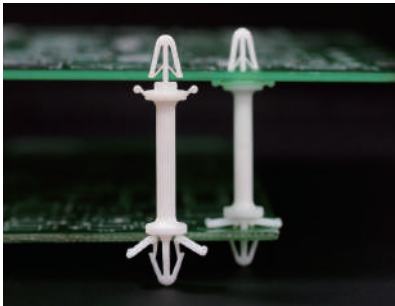

MOUNTING HOLE $\varnothing 4.0$
THICKNESS 1.6

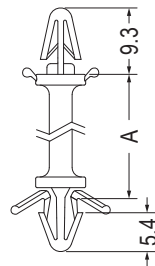

MOUNTING HOLE $\varnothing 4.8$
THICKNESS 2.0

Part No.	A	Package
LCBB-6.35	6.35	1000
LCBB-9.5	9.5	
LCBB-12.7	12.7	
LCBB-15.9	15.87	
LCBB-22.2	22.22	
LCBB-25.4	25.4	

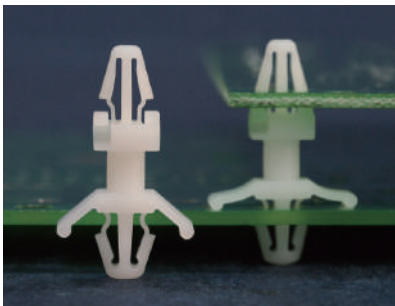

MOUNTING HOLE $\varnothing 4.0$
THICKNESS 1.2-2.0

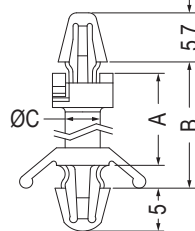

MOUNTING HOLE $\varnothing 4.8$
THICKNESS 0.8-2.0

Part No.	A	B	C	Package
VCBS-9	5.9	9.8		1000
VCBS-11	7.5	11.4	4.0	
VCBS-14	10.5	14.4	4.0	
VCBS-16	12.7	16.6	4.0	
VCBS-17	13.8	17.7	4.0	
VCBS-20	17.0	20.9	4.0	
VCBS-24	20.2	24.1	4.5	
VCBS-27	23.3	27.2	4.5	
VCBS-30	26.5	30.4	4.5	
VCBS-33	29.7	33.6	4.5	
VCBS-39	36.0	39.9	4.5	

MOUNTING HOLE $\varnothing 4.0$
THICKNESS 1.2-2.0

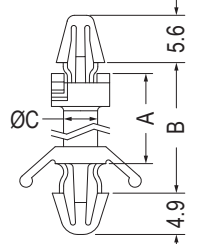

MOUNTING HOLE $\varnothing 4.8$
THICKNESS 0.8-3.0

Part No.	A	B	C	Package
VCBSL-9	5.0	9.8		1000
VCBSL-11	6.6	11.4	4.0	
VCBSL-14	9.6	14.4	4.0	
VCBSL-16	11.8	16.6	4.0	
VCBSL-17	12.9	17.7	4.0	
VCBSL-24	19.3	24.1	4.5	
VCBSL-27	22.4	27.2	4.5	
VCBSL-30	25.6	30.4	4.5	
VCBSL-33	28.8	33.6	4.5	
VCBSL-39	35.1	39.9	4.5	

PC板間隔柱 SPACER SUPPORT

用途：固定PC板於機板上，免工具易拆卸。

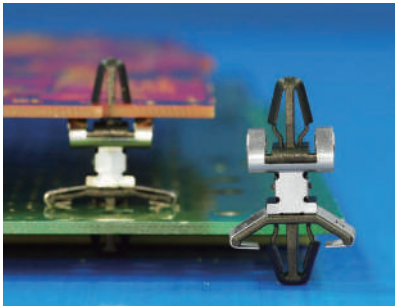

- Material: Nylon 66 (UL)
- Flame Class: 94V-2/94V-0
- Color: Natural/Black
- Unit: mm

MOUNTING HOLE $\varnothing 4.0$
THICKNESS 1.6~2.0

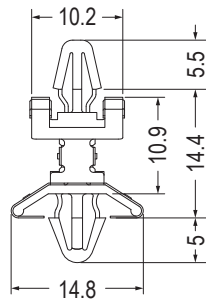

MOUNTING HOLE $\varnothing 4.8$
THICKNESS 1.0~2.0

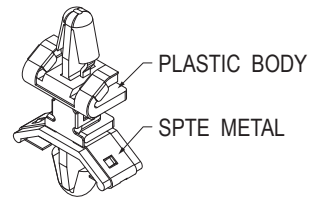

Part No.	Part No.	Package
VCBA-14.4F	VCBA-14.4ST	1000
	VCBA-14.4	

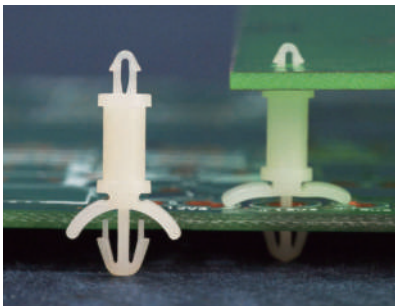

MOUNTING HOLE $\varnothing 2.0$
THICKNESS 1.6

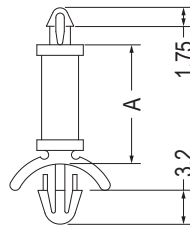

MOUNTING HOLE $\varnothing 3.0\sim\varnothing 3.2$
THICKNESS 0.8~2.0

Part No.	A	Package
LCMA-3.2	3.2	1000
LCMA-4.8	4.8	
LCMA-6.4	6.4	
LCMA-7.9	7.9	
LCMA-9.5	9.5	
LCMA-11.1	11.1	
LCMA-12.7	12.7	
LCMA-14.3	14.3	
LCMA-15.9	15.9	
LCMA-17	17.0	

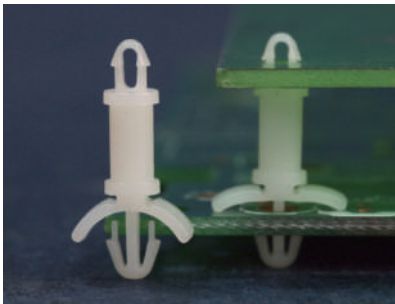

MOUNTING HOLE $\varnothing 2.5$
THICKNESS 1.6

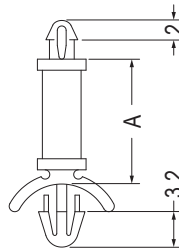

MOUNTING HOLE $\varnothing 3.0\sim\varnothing 3.2$
THICKNESS 0.8~2.0

Part No.	A	Package
LCMD-3.2	3.2	1000
LCMD-4.8	4.8	
LCMD-6.4	6.4	
LCMD-7.9	7.9	
LCMD-9.5	9.5	
LCMD-11.1	11.1	
LCMD-12.7	12.7	
LCMD-14.3	14.3	
LCMD-15.9	15.9	
LCMD-17	17.0	

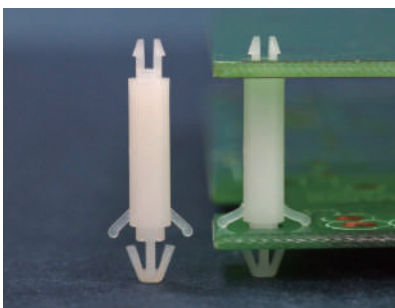

- Material: Nylon 66 (UL)
- Flame Class: 94V-2/94V-0
- Color: Natural/Black
- Unit: mm

用途：PC板與PC板間之固定，不佔空間。

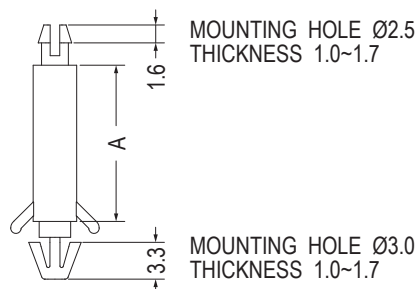

MOUNTING HOLE $\varnothing 2.5$
THICKNESS 1.0~1.7

MOUNTING HOLE $\varnothing 3.0$
THICKNESS 1.0~1.7

Part No.	A	Package
LCAB-12	12.0	1000
LCAB-14	14.0	

PC板間隔柱 SPACER SUPPORT

用途：固定PC板於機板上，免工具易拆卸。

1

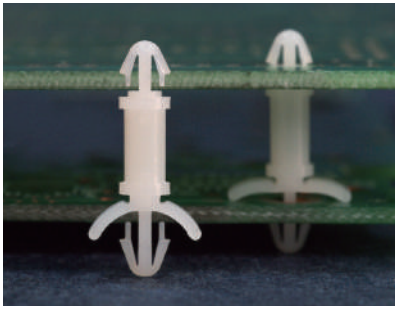

- Material: Nylon 66 (UL)
- Flame Class: 94V-2/94V-0
- Color: Natural/Black
- Unit: mm

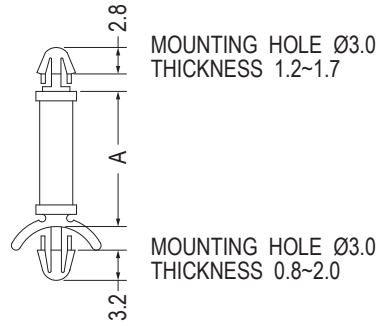

Part No.	A	Package
LCG-3	3.2	1000
LCG-5	4.8	
LCG-6	6.4	
LCG-8	7.9	
LCG-9	9.5	
LCG-11	11.1	
LCG-12	12.7	
LCG-14	14.3	
LCG-15	15.9	
LCG-17	17.0	
LCG-18	18.0	
LCG-19	19.0	
LCG-20	20.0	
LCG-26	26.0	

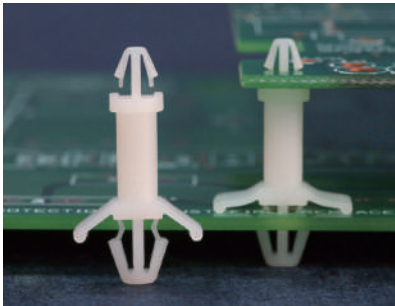

MOUNTING HOLE Ø3.0
THICKNESS 1.4~1.6

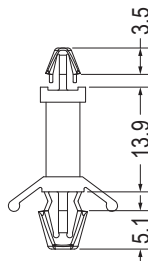

MOUNTING HOLE Ø4.8~Ø5.0
THICKNESS 0.8~2.0

Part No.	Package
LCBUA-13.9	1000

MOUNTING HOLE Ø3.0
THICKNESS 1.2~1.7

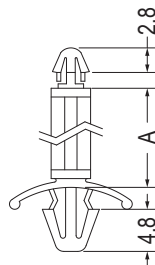

MOUNTING HOLE Ø4.8
THICKNESS 0.8~2.2

Part No.	A	Package
LCBT-3	3.2	1000
LCBT-5	4.8	
LCBT-6	6.3	
LCBT-8	8.0	
LCBT-10	10.0	
LCBT-12	12.0	
LCBT-14	14.0	
LCBT-16	16.0	
LCBT-18	18.0	
LCBT-25	25.0	

MOUNTING HOLE Ø3.5
THICKNESS 1.2~1.7

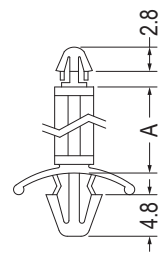

MOUNTING HOLE Ø4.8
THICKNESS 0.8~2.2

Part No.	A	Package
LCBU-3	3.2	1000
LCBU-5	5.0	
LCBU-6	6.3	
LCBU-8	8.0	
LCBU-10	10.0	
LCBU-12	12.0	
LCBU-14	14.0	
LCBU-16	16.0	
LCBU-18	18.0	
LCBU-25	25.0	

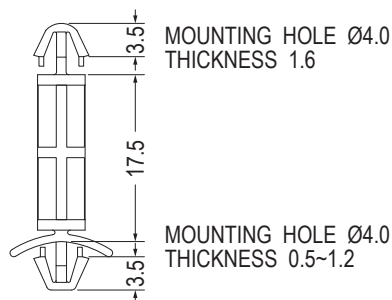
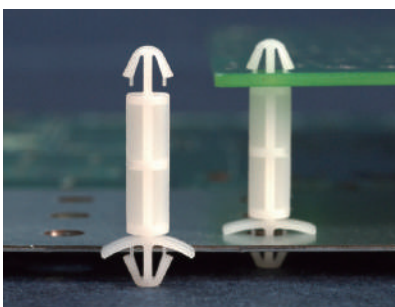

Part No.	Package
LCGB-17.5	1000

PC板間隔柱 SPACER SUPPORT

用途：固定PC板於機板上，免工具易拆卸。

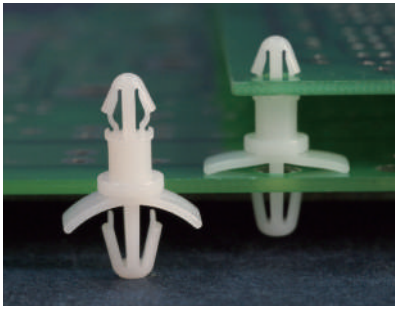

- Material: Nylon 66 (UL)
- Flame Class: 94V-2/94V-0
- Color: Natural/Black
- Unit: mm

MOUNTING HOLE Ø4.0
THICKNESS 1.6

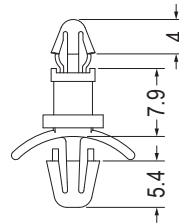

Part No.	Package
LCBC-8	1000

MOUNTING HOLE Ø4.8
THICKNESS 0.8-2.0

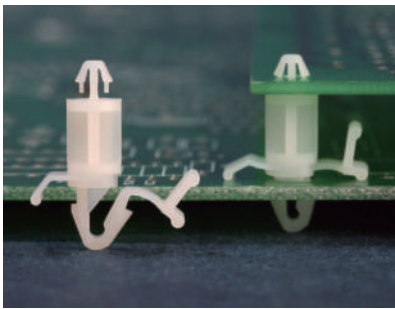

- Material: Nylon 66 (UL)
- Flame Class: 94V-2/94V-0
- Color: Natural/Black
- Unit: mm

用途：PC板與PC板間之固定，不佔空間，可在板上拆卸。

MOUNTING HOLE Ø3.0
THICKNESS 1.6

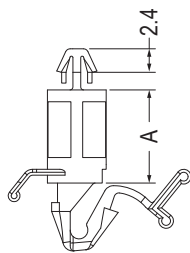

MOUNTING HOLE Ø4.8
THICKNESS 0.8-1.6

Part No.	A	Package
KLCBS-9.5	9.5	1000
KLCBS-12.7	12.7	
KLCBS-15.9	15.9	
KLCBS-19.1	19.1	

MOUNTING HOLE Ø3.5
THICKNESS 1.6

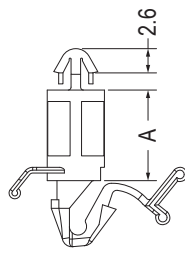

MOUNTING HOLE Ø4.8
THICKNESS 0.8-1.6

Part No.	A	Package
KLCBM-9.5	9.5	1000
KLCBM-12.7	12.7	
KLCBM-15.9	15.9	
KLCBM-19.1	19.1	

MOUNTING HOLE Ø4.0
THICKNESS 1.6

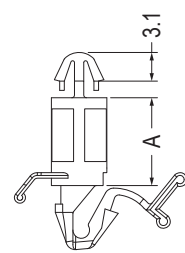

MOUNTING HOLE Ø4.8
THICKNESS 0.8-1.6

Part No.	A	Package
KLCBL-9.5	9.5	1000
KLCBL-12.7	12.7	
KLCBL-15.9	15.9	
KLCBL-19.1	19.1	

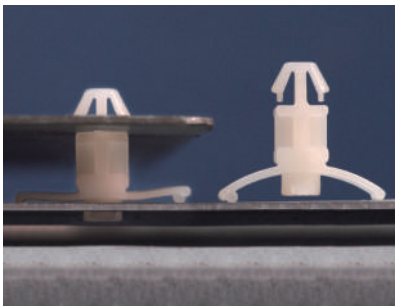

- Material: Nylon 66 (UL)
- Flame Class: 94V-2/94V-0
- Color: Natural/Black
- Unit: mm

MOUNTING HOLE Ø4.0
THICKNESS 1.0

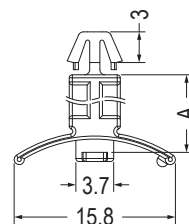

MOUNTING HOLE
THICKNESS 0.6-1.0

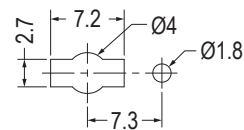

Part No.	A	Package
LCBA-5.6	5.6	1000
LCBA-7.6	7.6	

PC板間隔柱 SPACER SUPPORT

用途：固定PC板於機板上，免工具易拆卸。

1

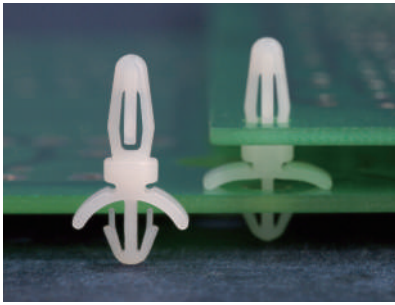

- Material: Nylon 66 (UL)
- Flame Class: 94V-2/94V-0
- Color: Natural/Black
- Unit: mm

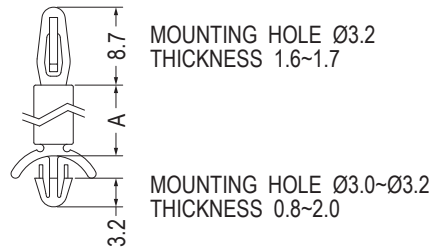

Part No.	A	Package
LCSE-3.2	3.2	1000
LCSE-4.8	4.8	
LCSE-6.4	6.4	
LCSE-7.9	7.9	
LCSE-9.5	9.5	
LCSE-11.1	11.1	
LCSE-12.7	12.7	
LCSE-14.3	14.3	
LCSE-15.9	15.9	
LCSE-17	17.0	

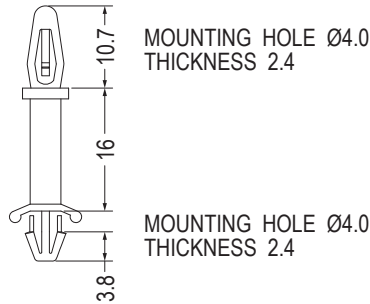
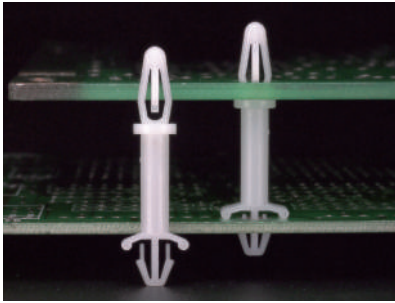

Part No.	Package
LCSJ-16	1000

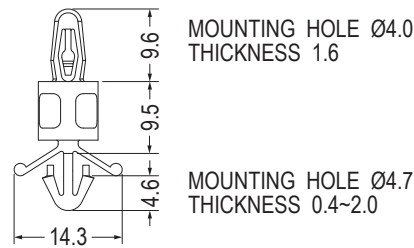
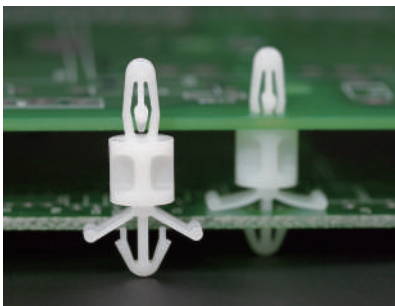

Part No.	Package
LCSH-9.5	1000

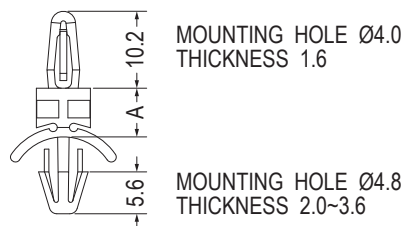
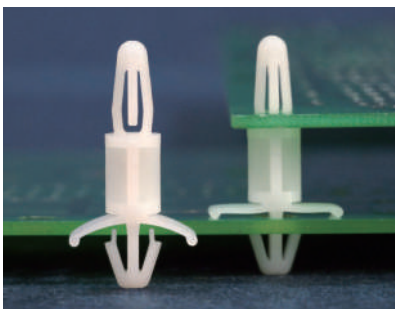

Part No.	A	Package
LCSA-6.4	6.4	1000
LCSA-9.5	9.5	

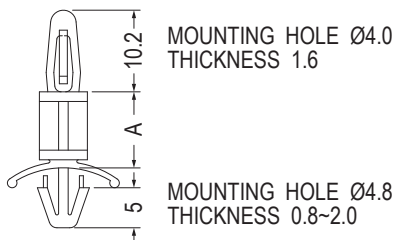

Part No.	A	Package
LCS-3	3.5	1000
LCS-5	4.8	
LCS-6	6.0	
LCS-6A	6.4	
LCS-8	7.9	
LCS-9	9.5	

Part No.	A	Package
LCS-11	11.1	1000
LCS-12	12.7	
LCS-16	15.9	
LCS-19	19.1	
LCS-22	22.2	
LCS-24	24.0	
LCS-25	25.4	
LCS-27.5	27.5	
LCS-28	28.6	
LCS-31.1	31.1	
LCS-31.7	31.7	
LCS-35	34.9	

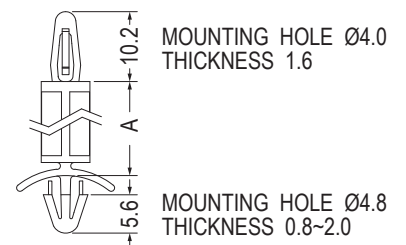

Part No.	A	Package
HLCS-4.8	4.8	1000
HLCS-6.4	6.4	
HLCS-9.5	9.5	
HLCS-12.7	12.7	
HLCS-15.9	15.9	
HLCS-25.4	25.4	
HLCS-40	40.0	500
HLCS-49	49.0	

PC板間隔柱 SPACER SUPPORT

用途：固定PC板於機板上，免工具易拆卸。

- Material: Nylon 66 (UL)
- Flame Class: 94V-2/94V-0
- Color: Natural/Black
- Unit: mm

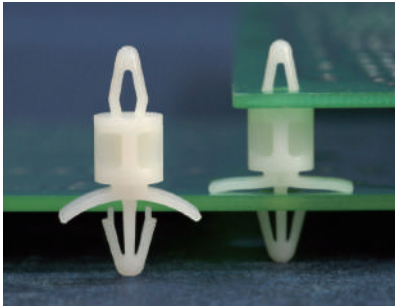
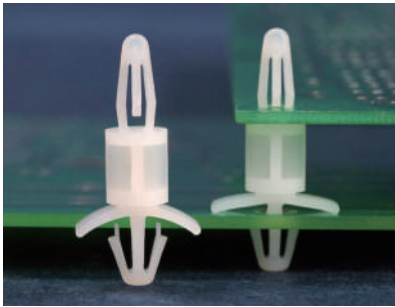

MOUNTING HOLE Ø4.0
THICKNESS 2.4

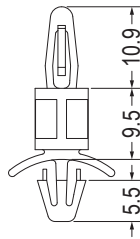

MOUNTING HOLE Ø4.8
THICKNESS 1.6

Part No.	Package
LCSLR-9.5	1000

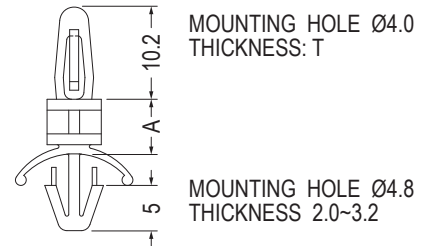

MOUNTING HOLE Ø4.0
THICKNESS: T

MOUNTING HOLE Ø4.8
THICKNESS 2.0~3.2

Part No.	A	T	Package
LCSD-4.8	4.8	1.6	1000
LCSD-9.5	9.5	1.6	
LCSD-12.7	12.7	1.6	
LCSL-4.8	4.8	2.0~3.2	

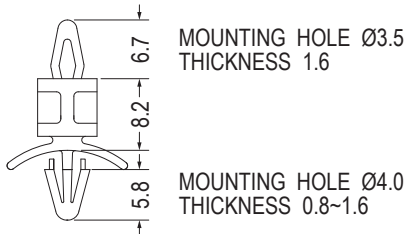

MOUNTING HOLE Ø3.5
THICKNESS 1.6

MOUNTING HOLE Ø4.0
THICKNESS 0.8~1.6

Part No.	Package
LCPA-8.2	1000

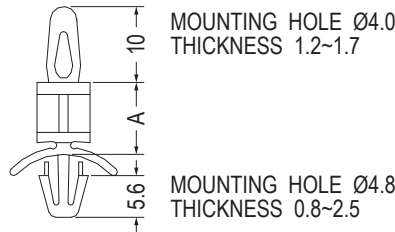

MOUNTING HOLE Ø4.0
THICKNESS 1.2~1.7

MOUNTING HOLE Ø4.8
THICKNESS 0.8~2.5

Part No.	A	Package
LCP-7.9	7.9	1000
LCP-9	9.5	
LCP-12.7	12.7	
LCP-22	22.2	

MOUNTING HOLE Ø4.0
THICKNESS 1.2~1.7

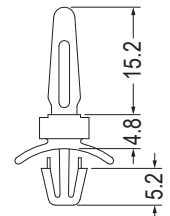

MOUNTING HOLE Ø4.8
THICKNESS 0.8~2.0

Part No.	Package
LCY-4.8	1000

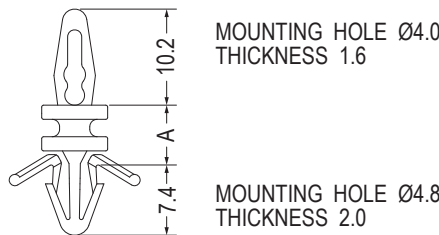
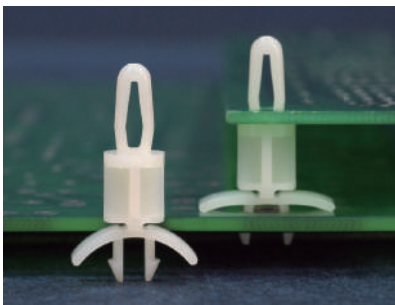
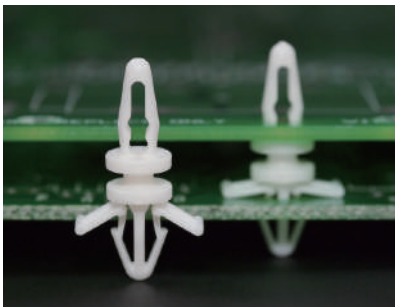

MOUNTING HOLE Ø4.0
THICKNESS 1.6

MOUNTING HOLE Ø4.8
THICKNESS 2.0

Part No.	A	Package
LCPD-6.35	6.35	1000
★LCPD-9.5	9.52	

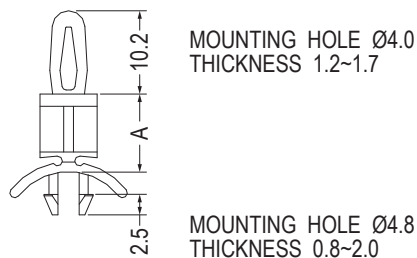

MOUNTING HOLE Ø4.0
THICKNESS 1.2~1.7

MOUNTING HOLE Ø4.8
THICKNESS 0.8~2.0

Part No.	A	Package
UCBS-5	4.8	1000
UCBS-6	6.4	
UCBS-9	9.5	
UCBS-12	12.7	
UCBS-15	15.9	
UCBS-19	19.1	
UCBS-22	22.2	

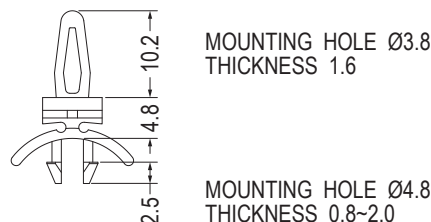

MOUNTING HOLE Ø3.8
THICKNESS 1.6

MOUNTING HOLE Ø4.8
THICKNESS 0.8~2.0

Part No.	Package
UCBS-5A	1000

PC板間隔柱 SPACER SUPPORT

用途：固定PC板於機板上，免工具易拆卸。

1

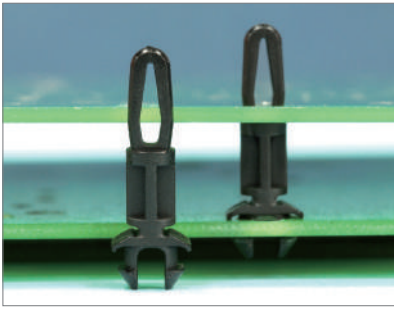

- Material: Nylon 66 (UL)
- Flame Class: 94V-2/94V-0
- Color: Natural/Black
- Unit: mm

MOUNTING HOLE Ø4.0
THICKNESS 1.2~1.7

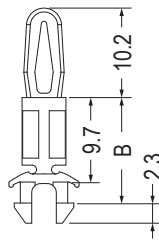

MOUNTING HOLE Ø5.4
THICKNESS: T

Part No.	B	T	Package
UCBSL-9	11.7	1.6	1000
UCBSL-10	12.0	2.2	

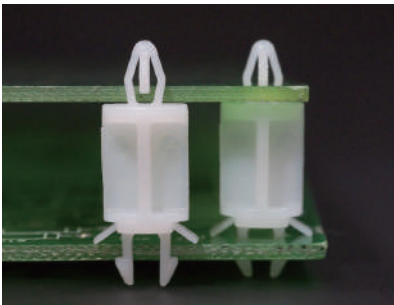

MOUNTING HOLE Ø3.3
THICKNESS 1.6

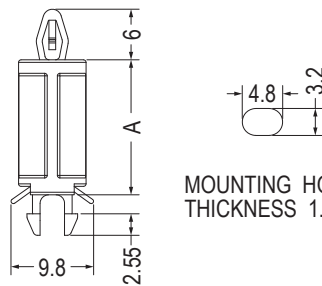

MOUNTING HOLE
THICKNESS 1.8~2.0

Part No.	A	Package
LMSD-12	12.0	1000
LMSD-16	16.0	

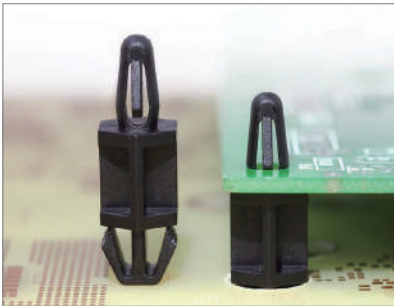

MOUNTING HOLE Ø4.0
THICKNESS 1.6

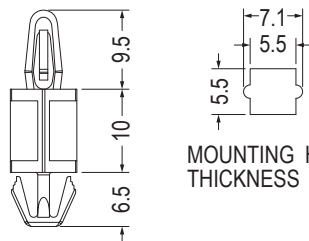

MOUNTING HOLE
THICKNESS 0.8~1.6

Part No.	Package
LCSI-10	1000

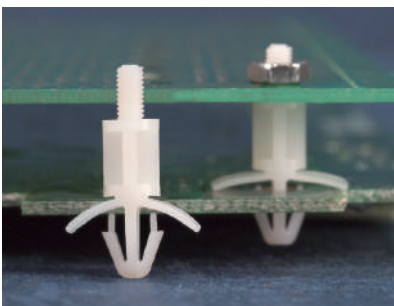

- Material: Nylon 66 (UL)
- Flame Class: 94V-2/94V-0
- Color: Natural/Black
- Unit: mm

用途：固定PC板於機板上，一頭配合螺母使用，不旋轉。

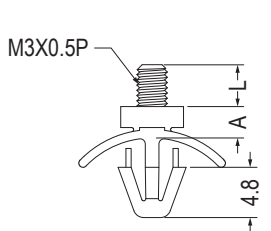

【 LCDS3-3, LCDS3-4 】

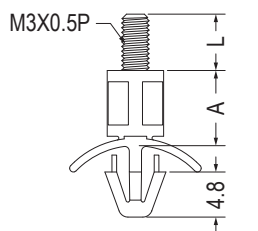

MOUNTING HOLE Ø4.8
THICKNESS 0.8~2.5

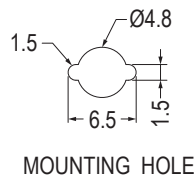

MOUNTING HOLE

Part No.	A	L	Package
LCDS3-3	3.0	4.0	1000
LCDS3-4	4.0	4.0	
LCDS3-5	5.0	4.0	
LCDS3-6	6.0	6.0	
LCDS3-7	7.0	6.0	
LCDS3-8	8.0	6.0	
LCDS3-9	9.0	6.0	
LCDS3-10	10.0	6.0	
LCDS3-11	11.0	6.0	
LCDS3-12	12.0	6.0	
LCDS3-13	13.0	6.0	
LCDS3-14	14.0	6.0	
LCDS3-15	15.0	6.0	

PC板間隔柱 SPACER SUPPORT

用途：固定PC板於機板上，一頭配合螺母使用，不旋轉。

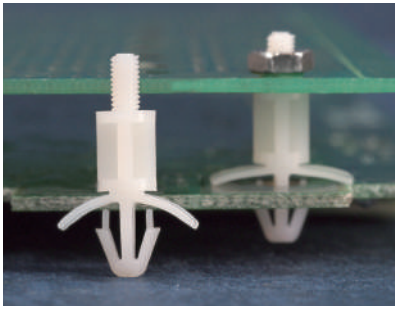

- Material: Nylon 66 (UL)
- Flame Class: 94V-2/94V-0
- Color: Natural/Black
- Unit: mm

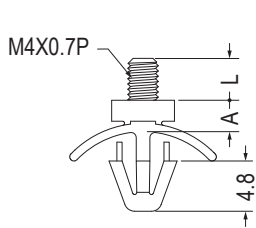

[LCDS4-3, LCDS4-4]

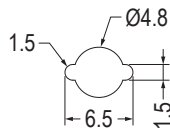
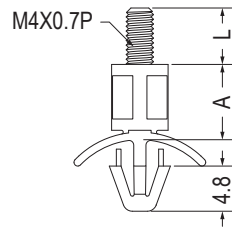

MOUNTING HOLE THICKNESS 0.8~2.5

Part No.	A	L	Package
LCDS4-3	3.0	4.0	1000
LCDS4-4	4.0	4.0	
LCDS4-5	5.0	4.0	
LCDS4-6	6.0	6.0	
LCDS4-7	7.0	6.0	
LCDS4-8	8.0	6.0	
LCDS4-9	9.0	6.0	
LCDS4-10	10.0	6.0	
LCDS4-11	11.0	6.0	
LCDS4-12	12.0	6.0	
LCDS4-13	13.0	6.0	
LCDS4-14	14.0	6.0	
LCDS4-15	15.0	6.0	

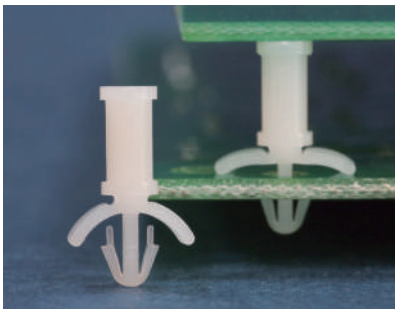

- Material: Nylon 66 (UL)
- Flame Class: 94V-2/94V-0
- Color: Natural/Black
- Unit: mm

用途：一端固定於機板上，另一端支撐PC板，避免下陷造成短路，PC板免鑽孔。

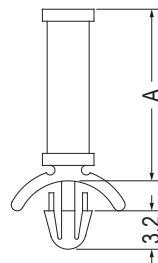

MOUNTING HOLE Ø3.0 THICKNESS 0.8~2.0

Part No.	A	Package
LBS-3	3.2	1000
LBS-5	4.8	
LBS-6	6.4	
LBS-8	7.9	
LBS-9	9.5	
LBS-11	11.1	
LBS-12	12.7	
LBS-14	14.3	
LBS-15	15.9	
LBS-17	17.0	
LBS-19	19.0	
LBS-20	20.0	
LBS-26	26.0	

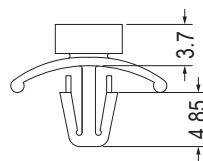
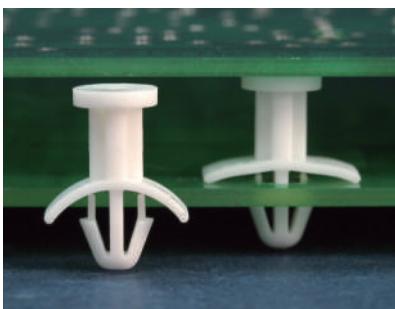

MOUNTING HOLE Ø4.0 THICKNESS 1.0~2.0

Part No.	Package
LASB-3.7	1000

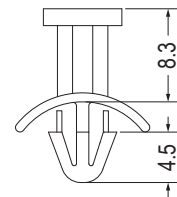

MOUNTING HOLE Ø4.5 THICKNESS 0.8~2.0

Part No.	Package
LASD-8.3	1000

PC板間隔柱 SPACER SUPPORT

1

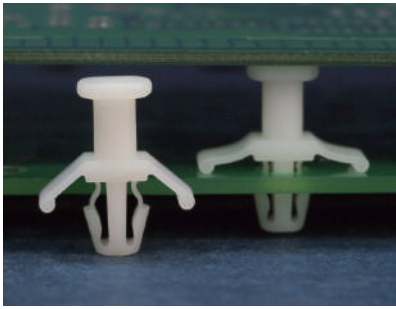

- Material: Nylon 66 (UL)
- Flame Class: 94V-2/94V-0
- Color: Natural/Black
- Unit: mm

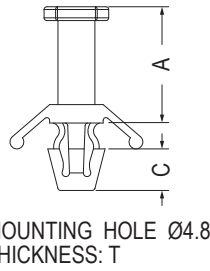

Part No.	A	C	T	Package
LASY-4.6	4.6	4.6	0.8~2.5	1000
LASY-9.3	9.3	4.5	0.5~2.3	
LASY-12.6	12.6	4.5	0.5~2.3	
LASY-15.9	15.9	4.5	0.5~2.3	

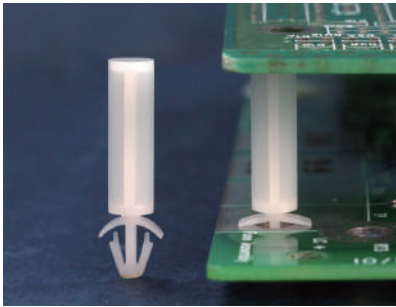
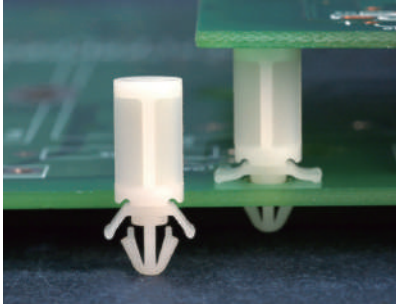

用途：一端固定於機板上，另一端支撐PC板，避免下陷造成短路，PC板免鑽孔。

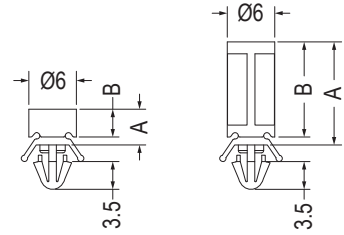

【LASE-4.5】 MOUNTING HOLE $\varnothing 3.5$
THICKNESS 1.2~1.6

Part No.	A	B	Package
LASE-4.5	4.5	3.5	1000
LASE-7	7.0	6.0	
LASE-12	12.0	11.0	

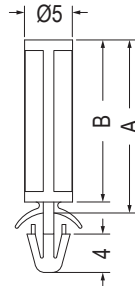

MOUNTING HOLE $\varnothing 3.5$
THICKNESS 1.6

Part No.	A	B	Package
LASJ-17	17.0	15.9	1000
LASJ-18	18.0	16.9	
LASJ-20	20.0	18.9	

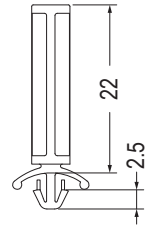

MOUNTING HOLE $\varnothing 3.5$
THICKNESS 0.8~1.8

Part No.	Package
LASH-22	1000

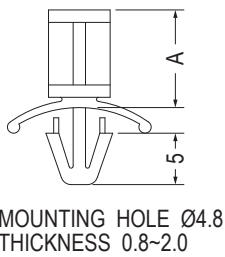

Part No.	A	Package
LAS-3	3.5	1000
LAS-5	4.8	
LAS-6	6.0	
LAS-6A	6.4	
LAS-8	7.9	
LAS-9	9.5	
LAS-11	11.1	
LAS-12	12.7	
LAS-16	15.9	

Part No.	A	Package
LAS-19	19.1	1000
LAS-22	22.2	
LAS-24	24.0	
LAS-25	25.4	
LAS-27.5	27.5	
LAS-28	28.6	
LAS-31.1	31.1	
LAS-31.7	31.7	
LAS-35	34.9	500

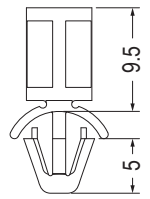

MOUNTING HOLE $\varnothing 4.8\sim\varnothing 5.0$
THICKNESS 0.8~2.0

Part No.	Package
LASA-9.5	1000

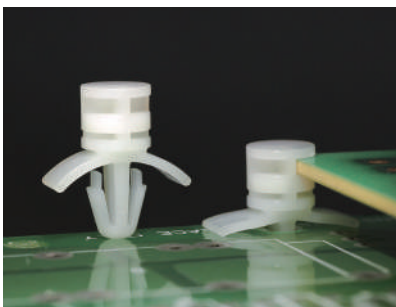

- Material: Nylon 66 (UL)
- Flame Class: 94V-2/94V-0
- Color: Natural/Black
- Unit: mm

用途：一端固定於機板上，另一端卡於PC板內。

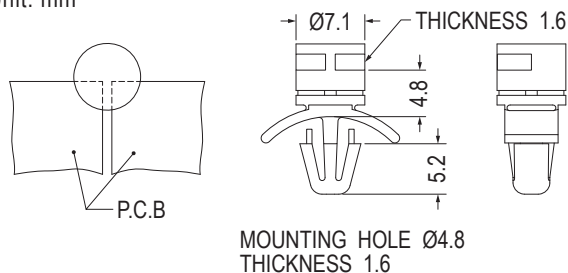

NEW

Part No.	Package
LASL-4.8	1000

PC板間隔柱 SPACER SUPPORT

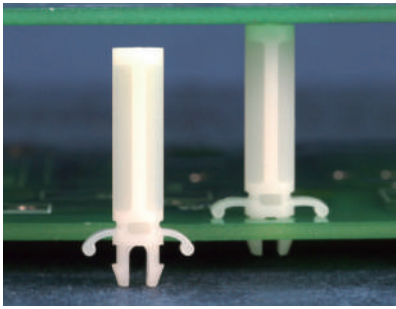

- Material: Nylon 66 (UL)
- Flame Class: 94V-2/94V-0
- Color: Natural/Black
- Unit: mm

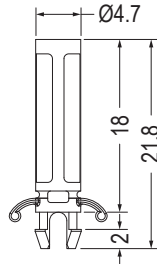

MOUNTING HOLE Ø4.0
THICKNESS 1.2~1.6

Part No.	Package
LASF-18	1000

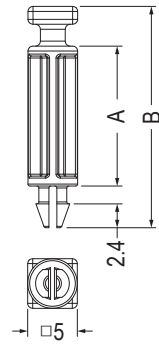
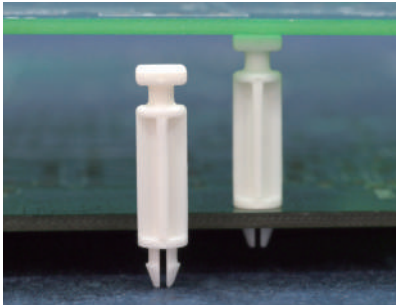

MOUNTING HOLE Ø3.0
THICKNESS 1.6

Part No.	A	B	Package
MSA-14.1	14.1	22.3	1000
MSA-24.3	24.3	32.5	

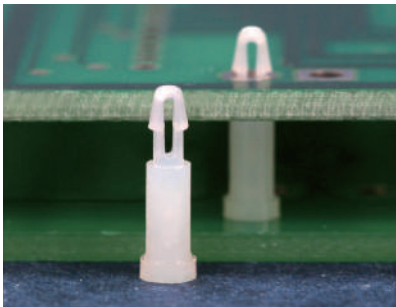

- Material: Nylon 66 (UL)
- Flame Class: 94V-2/94V-0
- Color: Natural/Black
- Unit: mm

MOUNTING HOLE Ø1.5
THICKNESS 1.0

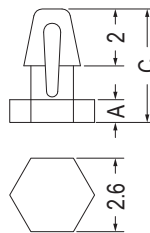

Part No.	A	C	Package
MASD-0.8	0.8	4.0	2000
MASD-2	2.0	5.2	

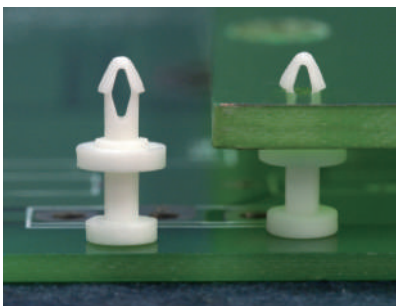

MOUNTING HOLE Ø1.5
THICKNESS 1.6

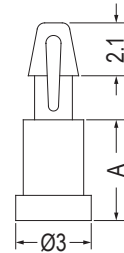

Part No.	A	Package
MASS-2	2.0	2000
MASS-2.5	2.5	
MASS-3	3.0	
MASS-3.5	3.5	
MASS-4	4.0	
MASS-5	5.0	
MASS-6	6.0	
MASS-6.5	6.5	

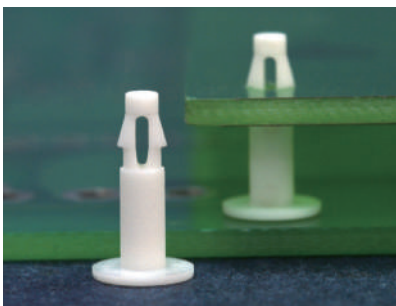

MOUNTING HOLE Ø2.0
THICKNESS 1.6

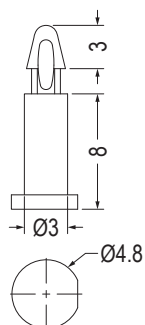

Part No.	Package
MAL-8	1000

MOUNTING HOLE Ø2.0
THICKNESS 2.4

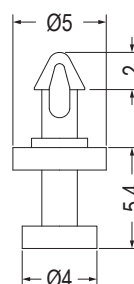

Part No.	Package
MASL-5.4	1000

MOUNTING HOLE Ø2.0
THICKNESS: T

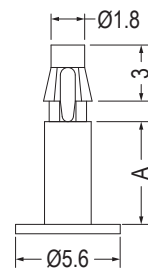

Part No.	A	T	Package
MAST-6	5.5	1.0	1000
MAST-18	18.3	1.6	

PC板間隔柱 SPACER SUPPORT

用途：支撐PC板，使中間不致震動，載重而凹陷短路。

1

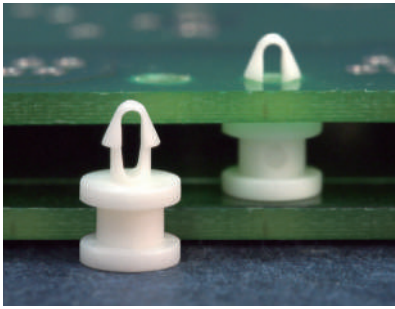

- Material: Nylon 66 (UL)
- Flame Class: 94V-2/94V-0
- Color: Natural/Black
- Unit: mm

MOUNTING HOLE Ø2.0
THICKNESS 1.4

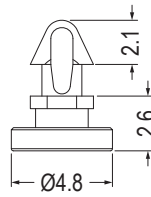

Part No.	Package
MABA-2.6	2000

MOUNTING HOLE Ø2.0
THICKNESS 1.6

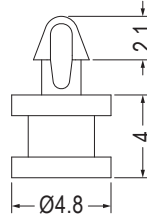

Part No.	Package
MAB-4	1000

MOUNTING HOLE Ø2.0
THICKNESS 1.0

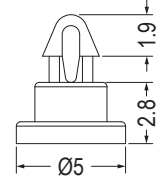

Part No.	Package
MA-2.8S	2000

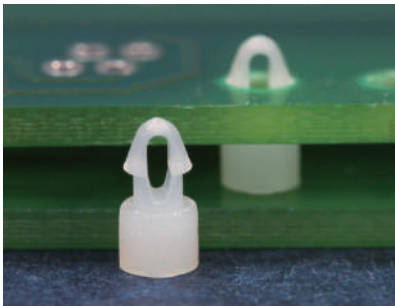
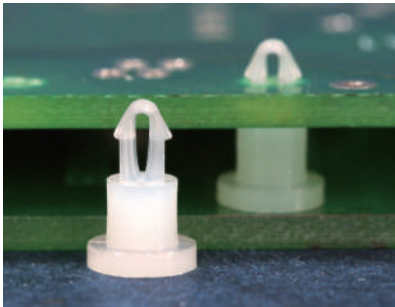

MOUNTING HOLE Ø2.0
THICKNESS 1.0

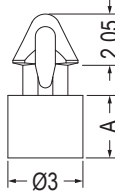

Part No.	A	Package
MA-2.5S	2.5	2000
MA-3S-1	3.0	

MOUNTING HOLE Ø2.0
THICKNESS 1.6

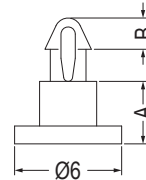

Part No.	A	B	Package
MA-2.7DL	2.7	1.9	2000
MA-3.5DL	3.5	1.75	
MA-3.85DL	3.85	1.9	
MA-4.5DL	4.5	1.9	
MA-5DL	5.0	1.9	
MA-6.5DL	6.5	1.9	

MOUNTING HOLE Ø2.0
THICKNESS: T

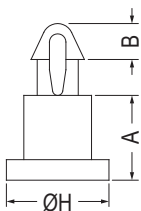

Part No.	A	B	H	T	Package
MA-1.8	1.8	1.9	4.2	1.6	2000
MA-2	2.0	1.9	4.2	1.6	
MA-2L	2.0	2.05	4.8	2.0	
MA-2.5	2.5	1.9	4.1	1.6	
MA-2.5L	2.5	2.0	4.8	1.6	
MA-3	3.0	1.9	4.8	1.6	
MA-3SA	3.0	1.8	4.2	1.6	
MA-3S	3.0	1.8	4.2	1.6	
MA-3.2	3.2	1.9	4.8	1.6	
MA-3.2-1	3.2	2.1	4.8	1.6	
MA-3.5	3.5	1.9	4.2	1.6	
MA-3.5L	3.5	2.0	4.8	1.6	
MA-3.75	3.75	2.0	4.8	1.6	
MA-4	4.0	1.9	4.8	1.6	
MA-4.5	4.5	1.9	4.2	1.6	
MA-4.7	4.7	1.9	4.8	1.6	
MA-5	5.0	1.9	4.8	1.6	
MA-5.6	5.6	2.0	4.2	1.6	
MA-6	6.0	1.9	5.0	1.6	
MA-6.5	6.5	1.9	5.0	1.6	
MA-6.75	6.75	1.9	5.0	1.6	
MA-8	8.0	1.9	5.0	1.6	
MA-9	9.0	1.9	5.0	1.6	

MOUNTING HOLE Ø2.5
THICKNESS 1.0

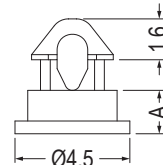

Part No.	A	Package
MAMS-1.5	1.5	2000
MAMS-1.7	1.7	
MAMS-5	5.0	

MOUNTING HOLE Ø2.5
THICKNESS 1.0

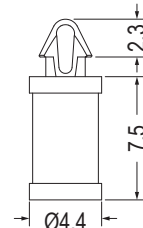

Part No.	Package
MAMS-7.5	1000

PC板間隔柱 SPACER SUPPORT

用途：支撐PC板，使中間不致震動，載重而凹陷短路。

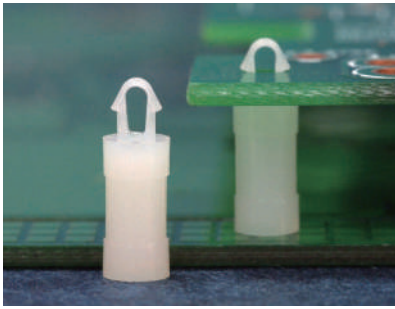

- Material: Nylon 66 (UL)
- Flame Class: 94V-2/94V-0
- Color: Natural/Black
- Unit: mm

MOUNTING HOLE Ø2.6
THICKNESS 1.6

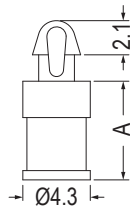

【 MAM-6.35L 】

MOUNTING HOLE Ø2.5
THICKNESS 1.6

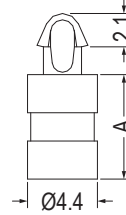

Part No.	A	Package
MAM-6.35L	6.35	2000
MAM-6.8	6.8	
MAM-7	7.0	
MAM-8	8.0	
MAM-8.4	8.4	
MAM-9	9.0	
MAM-9.5	9.5	
MAM-11	11.1	
MAM-12.7	12.7	
MAM-15.9	15.9	



MOUNTING HOLE Ø2.5
THICKNESS 1.6~1.8

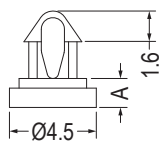

【 MAM-1.5L 】

MOUNTING HOLE Ø2.5
THICKNESS 1.4~1.6

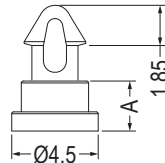

【 MAM-2.6 】

Part No.	A	Package
MAM-1.5	1.5	2000
MAM-1.5L	1.5	
MAM-2	2.0	
MAM-2.5	2.5	
MAM-2.6	2.6	
MAM-2.7	2.7	
MAM-3	3.0	
MAM-3.2	3.2	
MAM-3.5	3.5	
MAM-4	4.0	
MAM-4.5	4.5	
MAM-4.8	4.8	
MAM-5	5.0	
MAM-5.7	5.7	
MAM-6	6.0	
MAM-6.4	6.4	

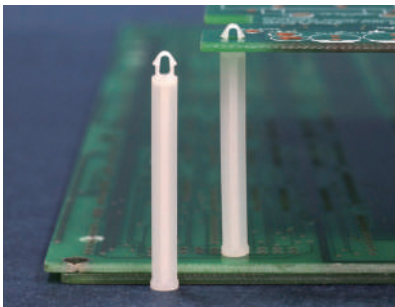

MOUNTING HOLE Ø2.5
THICKNESS 1.6

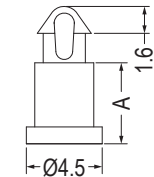

【 MAM-4.8, MAM-6.4 】

MOUNTING HOLE Ø2.5
THICKNESS 1.6~1.8

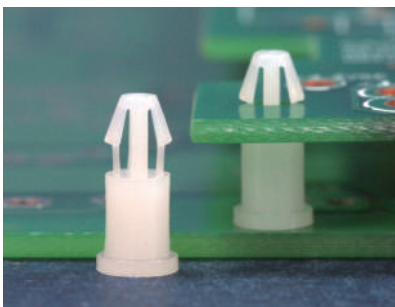
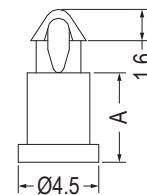

MOUNTING HOLE Ø2.7
THICKNESS 1.6

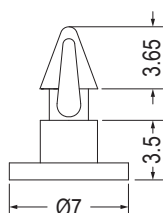

Part No.	Package
MAMA-3.5	1000

MOUNTING HOLE Ø3.0
THICKNESS 1.6

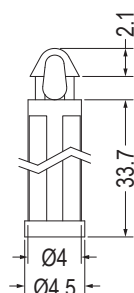

Part No.	Package
MAL-34	1000

MOUNTING HOLE Ø3.0
THICKNESS: T

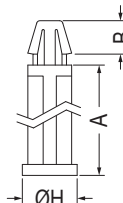

【 DCC-20S 】

MOUNTING HOLE Ø3.0
THICKNESS: T

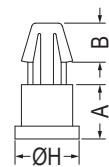

Part No.	A	B	H	T	Package
DCC-2	2.0	3.1	5.0	1.2~1.6	2000
DCC-2.5	2.5	3.1	5.0	1.2~1.6	
DCC-2.7	2.7	3.1	5.0	1.2~1.6	
DCC-3	3.0	3.1	5.0	1.2~1.6	
DCC-3.2	3.2	3.1	5.0	1.2~1.6	
DCC-3.5	3.5	3.1	5.0	1.2~1.6	
DCC-4	4.0	3.1	5.0	1.2~1.6	
DCC-4.5	4.5	3.1	5.0	1.2~1.6	
DCC-5	5.0	3.1	5.0	1.2~1.6	
DCC-5S	5.0	2.6	5.0	0.8~1.2	
DCC-5.5	5.5	3.1	5.0	1.2~1.6	
DCC-6	6.0	3.1	5.0	1.2~1.6	
DCC-6.2	6.2	3.1	5.0	1.2~1.6	
DCC-6.5	6.5	3.1	5.0	1.2~1.6	
DCC-9.5L	9.5	3.1	6.0	1.2~1.6	
DCC-20S	20.0	3.1	5.0	0.8	

PC板間隔柱 SPACER SUPPORT

用途：支撐PC板，使中間不致震動，載重而凹陷短路。

1

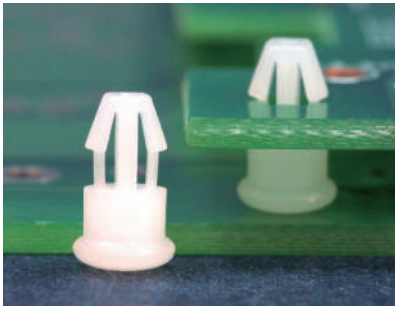

- Material: Nylon 66 (UL)
- Flame Class: 94V-2/94V-0
- Color: Natural/Black
- Unit: mm

MOUNTING HOLE $\varnothing 3.0$
THICKNESS 1.6

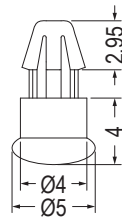

Part No.	Package
DCE-4	1000

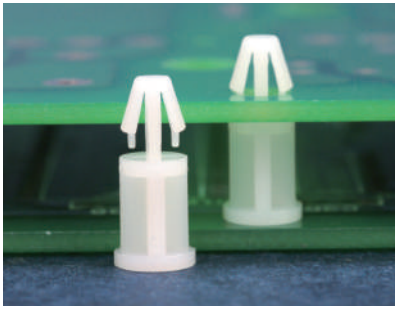

MOUNTING HOLE $\varnothing 3.5$
THICKNESS 0.8~1.6

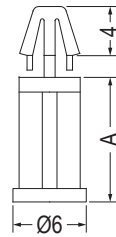

Part No.	A	Package
MCM-8	8.0	1000
MCM-14.5	14.5	



MOUNTING HOLE $\varnothing 3.7$
THICKNESS 1.6

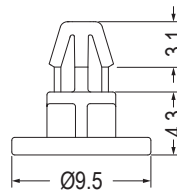

Part No.	Package
DCCA-4.3	1000

MOUNTING HOLE $\varnothing 4.0$
THICKNESS 1.2~1.6

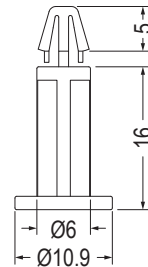

Part No.	Package
MCO-16	1000

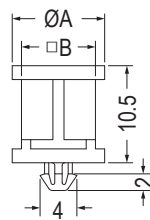
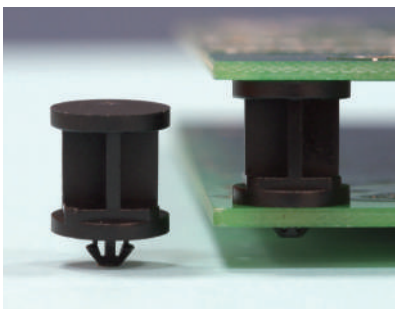

MOUNTING HOLE $\varnothing 3.0$
THICKNESS: T

Part No.	A	B	T	Package
TCBA-10.5S	7.5	6.0	1.0	1000
TCBA-10.5	10.0	8.0	1.0	
TCBA-10.5L	10.0	8.0	1.6	

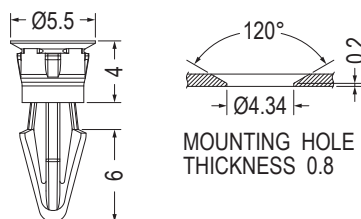

MOUNTING HOLE $\varnothing 3.0\sim\varnothing 3.18$
THICKNESS 1.6

Part No.	Package
DCCB-4.1	1000

PC板間隔柱 SPACER SUPPORT

用途：支撐PC板，使中間不致震動，載重而凹陷短路。

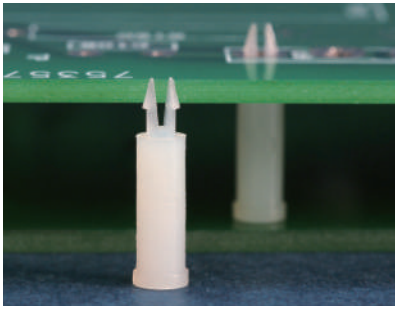

- Material: Nylon 66 (UL)
- Flame Class: 94V-2/94V-0
- Color: Natural/Black
- Unit: mm

MOUNTING HOLE $\varnothing 2.0$
THICKNESS 1.2~1.8

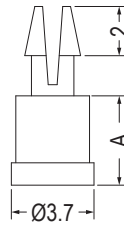

Part No.	A	Package
MS-4	4.0	2000
MS-5	5.0	
MS-10	10.0	

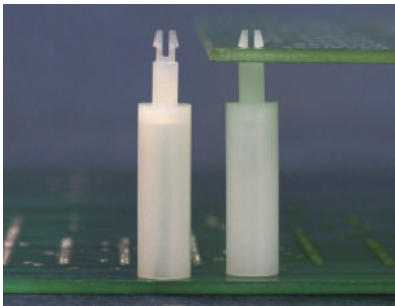

MOUNTING HOLE $\varnothing 2.2$
THICKNESS 1.6

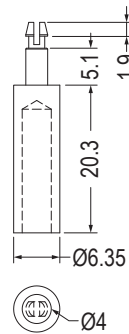

Part No.	Package
PCLS-25	1000

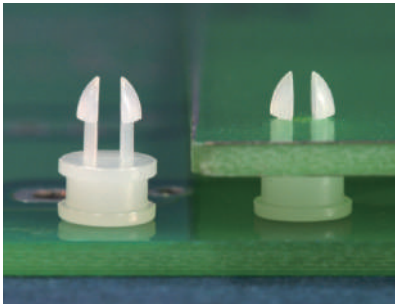

MOUNTING HOLE $\varnothing 2.3$
THICKNESS 1.6

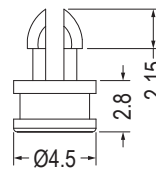

Part No.	Package
MSB-2.8	1000

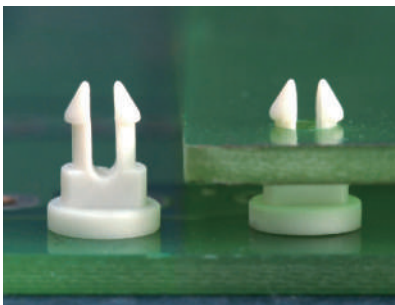

- Material: PBT (UL)
- Flame Class: 94V-0
- Color: Natural
- Unit: mm

MOUNTING HOLE $\varnothing 2.5$
THICKNESS 1.6

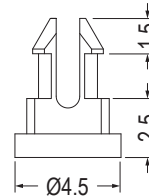

Part No.	Package
MSM-2.5	1000

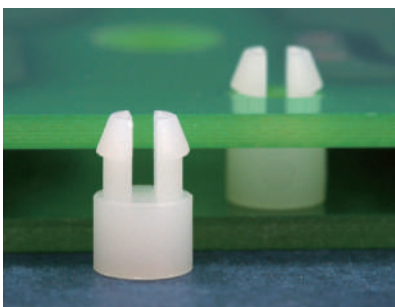

- Material: Nylon 66 (UL)
- Flame Class: 94V-2/94V-0
- Color: Natural/Black
- Unit: mm

MOUNTING HOLE $\varnothing 3.9$
THICKNESS 1.6

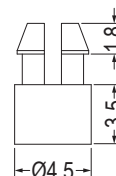

Part No.	Package
MSMA-3.5	2000

PC板間隔柱 SPACER SUPPORT

1



- Material: Nylon 66 (UL)
- Flame Class: 94V-2/94V-0
- Color: Natural/Black
- Unit: mm

MOUNTING HOLE Ø2.5
THICKNESS 1.6

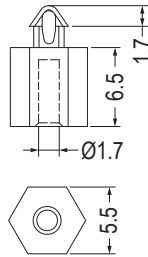

Part No.	Package
MAE2.5-6.5	2000

MOUNTING HOLE Ø2.5
THICKNESS 1.6

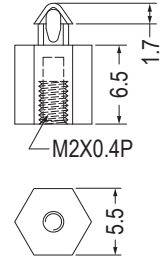

• MAE2.5-6.5T為已攻牙M2X0.4P

Part No.	Package
MAE2.5-6.5T	2000

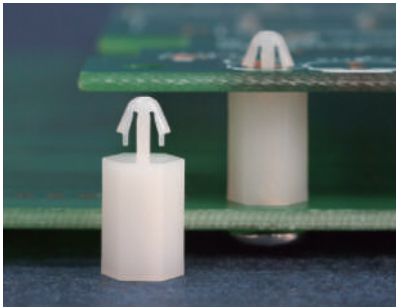

- Material: Nylon 66 (UL)
- Flame Class: 94V-2/94V-0
- Color: Natural/Black
- Unit: mm

用途：PC板端直接壓入固定，另一端可配合M3螺絲或自攻螺絲固定。

MOUNTING HOLE Ø3.0
THICKNESS 1.6

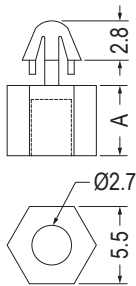

Part No.	A	Package
MAE-4	4.0	1000
MAE-5	5.0	2000
MAE-6	6.0	
MAE-7	7.0	
MAE-8	8.0	
MAE-9	9.0	
MAE-10	10.0	1000
MAE-11	11.0	
MAE-12	12.0	
MAE-13	13.0	

Part No.	A	Package
MAE-14	14.0	1000
MAE-15	15.0	
MAE-16	16.0	
MAE-17	17.0	
MAE-18	18.0	
MAE-19	19.0	
MAE-20	20.0	
MAE-22	22.0	
MAE-23.5	23.5	
MAE-26	26.0	

MOUNTING HOLE Ø3.0
THICKNESS 1.6

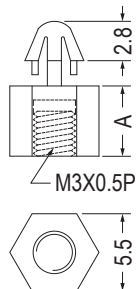

• MAE-XT為已攻牙M3X0.5P

Part No.	A	Package
MAE-5T	5.0	2000
MAE-6T	6.0	
MAE-7T	7.0	
MAE-8T	8.0	
MAE-9T	9.0	
MAE-10T	10.0	1000
MAE-11T	11.0	
MAE-12T	12.0	
MAE-13T	13.0	
MAE-14T	14.0	
MAE-15T	15.0	

Part No.	A	Package
MAE-16T	16.0	1000
MAE-17T	17.0	
MAE-18T	18.0	
MAE-19T	19.0	
MAE-20T	20.0	
MAE-22T	22.0	
MAE-23.5T	23.5	
MAE-26T	26.0	
MAE-26.5T	26.5	
MAE-27T	27.0	

PC板間隔柱 SPACER SUPPORT

用途：PC板端直接壓入固定，另一端可配合M3螺絲或自攻螺絲固定。

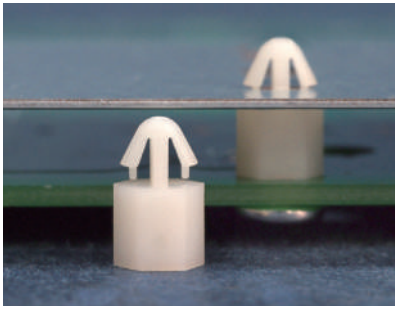

- Material: Nylon 66 (UL)
- Flame Class: 94V-2/94V-0
- Color: Natural/Black
- Unit: mm

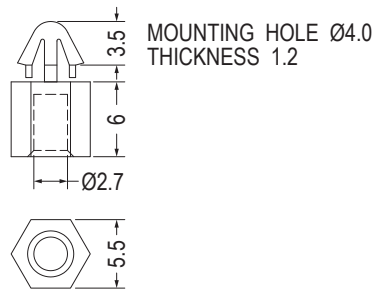

Part No.	Package
MAE4D-6	1000

MOUNTING HOLE Ø4.0
THICKNESS 1.2

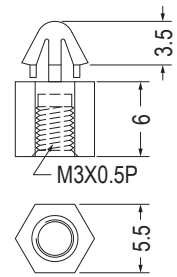

• MAE4D-6T為已攻牙M3X0.5P

Part No.	Package
MAE4D-6T	1000

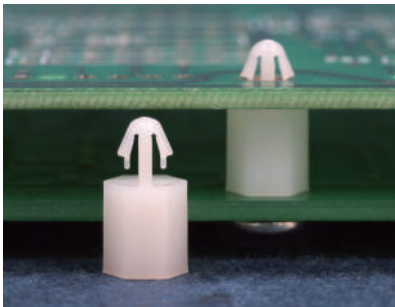

- Material: Nylon 66 (UL)
- Flame Class: 94V-2/94V-0
- Color: Natural/Black
- Unit: mm

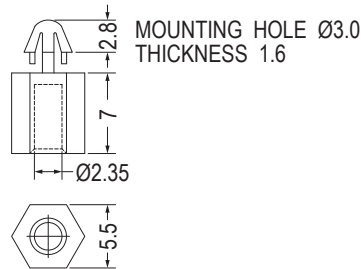

Part No.	Package
MAE7-440	2000

用途：PC板端直接壓入固定，另一端可配合螺絲或自攻螺絲固定。

MOUNTING HOLE Ø3.0
THICKNESS 1.6

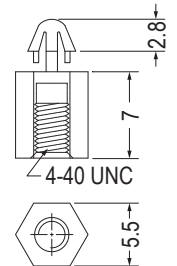

• MAE7-440T為已攻牙4-40UNC

Part No.	Package
MAE7-440T	2000

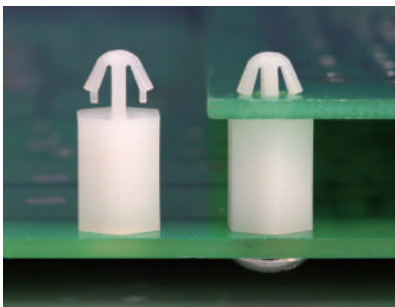

- Material: Nylon 66 (UL)
- Flame Class: 94V-2/94V-0
- Color: Natural/Black
- Unit: mm

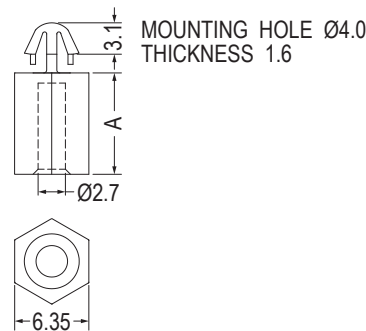

Part No.	A	Package
MAE43-5	5.0	2000
MAE43-6	6.0	
MAE43-7	7.0	
MAE43-8	8.0	
MAE43-9	9.0	
MAE43-10	10.0	
MAE43-11	11.0	
MAE43-12.7	12.7	
MAE43-14	14.0	
MAE43-15	15.0	
MAE43-15.9	15.9	
MAE43-20	20.0	

用途：PC板端直接壓入固定，另一端可配合M3螺絲或自攻螺絲固定。

MOUNTING HOLE Ø4.0
THICKNESS 1.6

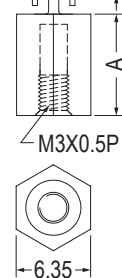

• MAE43-XT為已攻牙M3X0.5P

Part No.	A	Package
MAE43-5T	5.0	2000
MAE43-6T	6.0	
MAE43-7T	7.0	
MAE43-8T	8.0	
MAE43-9T	9.0	
MAE43-10T	10.0	
MAE43-11T	11.0	
MAE43-12.7T	12.7	
MAE43-14T	14.0	
MAE43-15T	15.0	
MAE43-15.9T	15.9	
MAE43-20T	20.0	

MOUNTING HOLE Ø4.0
THICKNESS 1.85

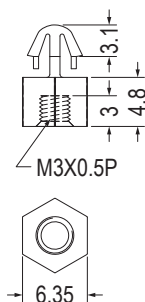

Part No.	Package
MAE43-4.8LT	1000

PC板間隔柱 SPACER SUPPORT

1

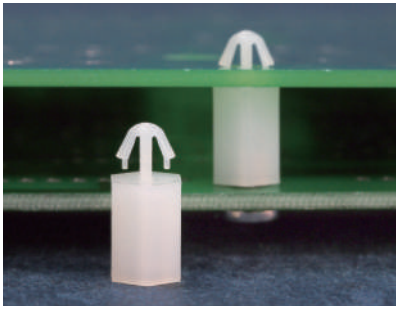

- Material: Nylon 66 (UL)
- Flame Class: 94V-2/94V-0
- Color: Natural/Black
- Unit: mm

MOUNTING HOLE Ø4.0
THICKNESS 1.6

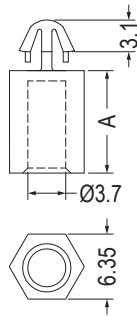

Part No.	A	Package
MAE4-5	5.0	2000
MAE4-6	6.0	
MAE4-7	7.0	
MAE4-8	8.0	
MAE4-9	9.0	
MAE4-10	10.0	
MAE4-11	11.0	
MAE4-12.7	12.7	
MAE4-14	14.0	
MAE4-15	15.0	
MAE4-15.9	15.9	
MAE4-20	20.0	

用途：PC板端直接壓入固定，另一端可配合M4螺絲或自攻螺絲固定。

MOUNTING HOLE Ø4.0
THICKNESS 1.6

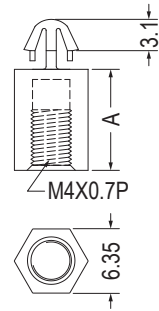

• MAE4-XT為已攻牙M4X0.7P

Part No.	A	Package
MAE4-5T	5.0	2000
MAE4-6T	6.0	
MAE4-7T	7.0	
MAE4-8T	8.0	
MAE4-9T	9.0	
MAE4-10T	10.0	
MAE4-11T	11.0	
MAE4-12.7T	12.7	
MAE4-14T	14.0	
MAE4-15T	15.0	
MAE4-15.9T	15.9	
MAE4-20T	20.0	

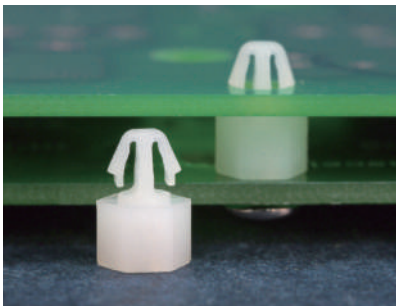

- Material: Nylon 66 (UL)
- Flame Class: 94V-2/94V-0
- Color: Natural/Black
- Unit: mm

MOUNTING HOLE Ø4.0
THICKNESS 1.6

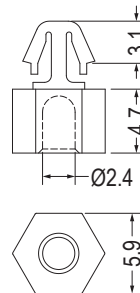

用途：機板部分用鐵板自攻螺絲固定，另一頭直接壓入PC板。

Part No.	Package
MCI-4.7	1000

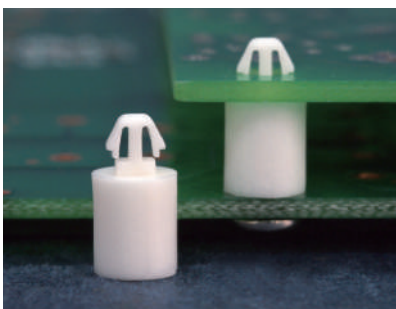

- Material: Nylon 66 (UL)
- Flame Class: 94V-2/94V-0
- Color: Natural/Black
- Unit: mm

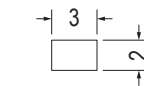
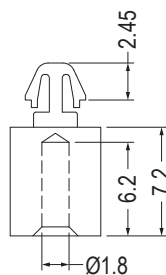

MOUNTING HOLE
THICKNESS 1.6

Part No.	Package
MCSH-7.2	1000

PC板間隔柱 SPACER SUPPORT

用途：支撐PC板，使中間不致震動，載重而凹陷短路。

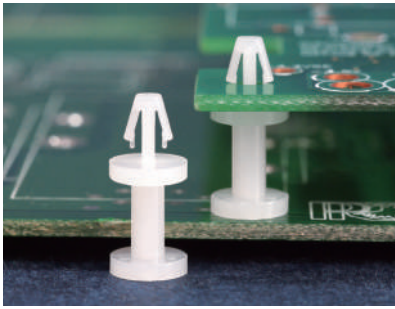

- Material: Nylon 66 (UL)
- Flame Class: 94V-2/94V-0
- Color: Natural/Black
- Unit: mm

MOUNTING HOLE Ø3.0
THICKNESS 1.6

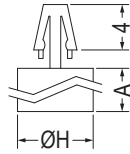

MOUNTING HOLE Ø3.0
THICKNESS: T

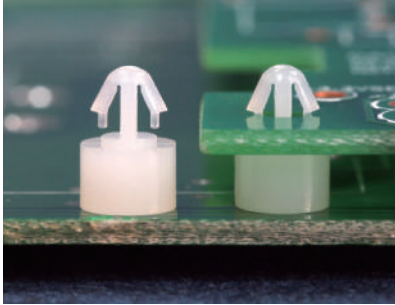
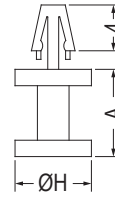

Part No.	A	H	Package
DCB-2	2.0	6.5	2000
DCB-2.5	2.5	6.5	
DCB-3	3.0	6.8	
DCB-3.5	3.5	6.8	1000
DCB-4	4.0	6.8	

Part No.	A	H	T	Package
DCB-5	5.0	6.0	1.6	1000
DCB-5.8	5.8	6.9	1.6	
DCB-6	6.0	6.8	1.6	
DCB-6.5	6.5	6.0	1.6	
DCB-7	7.0	6.0	1.6	
DCB-8	8.0	6.8	1.6	
DCB-8(2)	8.0	6.8	2.1	
DCB-10	10.0	6.8	1.6	
DCB-15	15.0	6.0	1.6	
DCB-15L	15.0	15.0	1.6	
DCB-15S	15.0	6.0	1.6	

MOUNTING HOLE Ø3.0
THICKNESS: T

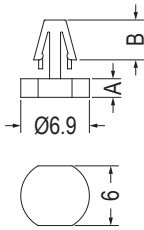

[DCB-2D,
DCB-3D,
DCB-3.5D]

MOUNTING HOLE Ø3.0
THICKNESS: T

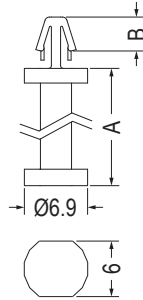

[DCB-15D]

MOUNTING HOLE Ø3.0
THICKNESS: T

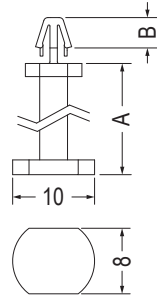

[DCB-16DL,
DCB-20DL]

MOUNTING HOLE Ø3.0
THICKNESS: T

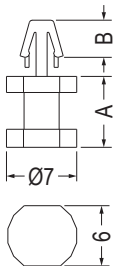

Part No.	A	B	T	Package
DCB-2D	2.0	3.5	1.2~1.7	2000
DCB-3D	3.0	3.7	1.2~1.6	
DCB-3.5D	3.5	4.0	1.2~1.6	
DCB-4D	4.0	3.6	1.2~1.7	1000
DCB-4.5D	4.5	3.6	1.2~1.7	
DCB-5D	5.0	3.6	1.2~1.7	
DCB-5.5D	5.5	4.0	1.2~1.6	
DCB-7D	7.0	4.0	1.2~1.6	

Part No.	A	B	T	Package
DCB-8D	8.0	3.85	1.2~1.7	1000
DCB-8.5D	8.5	4.0	1.2~1.7	
DCB-9D	9.0	4.0	1.2~1.6	
DCB-11D	11.0	3.7	1.2~1.6	
DCB-12D	12.0	4.0	1.2~1.6	
DCB-13D	13.0	4.0	1.2~1.6	
DCB-15D	15.0	3.7	1.2~1.6	
DCB-16DL	16.0	3.7	1.2~1.6	
DCB-20DL	20.0	3.7	1.2~1.6	

MOUNTING HOLE Ø3.0
THICKNESS 3.0

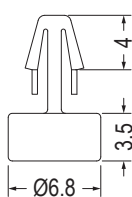

Part No.	Package
DCBA-3.5	1000

MOUNTING HOLE Ø3.1
THICKNESS 1.6

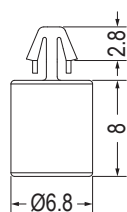

Part No.	Package
DCBA-8	1000

MOUNTING HOLE Ø3.5
THICKNESS 1.6

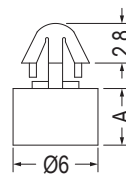

Part No.	A	Package
PDC-3	3.0	2000
PDC-3.5	3.5	
PDC-4	4.0	

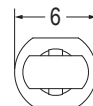

MOUNTING HOLE Ø3.5
THICKNESS 1.6

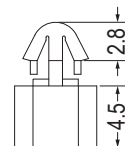

Part No.	Package
PDC-4.5D	2000

PC板間隔柱 SPACER SUPPORT

用途：支撐PC板，使中間不致震動，載重而凹陷短路。

1

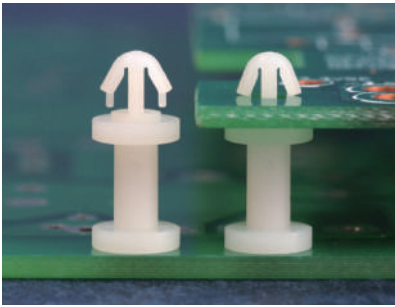

- Material: Nylon 66 (UL)
- Flame Class: 94V-2/94V-0
- Color: Natural/Black
- Unit: mm

MOUNTING HOLE Ø3.5
THICKNESS: T

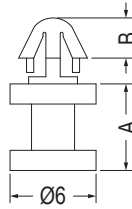

Part No.	A	B	T	Package
PDC-5	5.0	2.8	1.6	2000
PDC-9	9.0	2.8	1.6	
PDC-10	10.0	2.6	1.8	

MOUNTING HOLE Ø3.5
THICKNESS: T

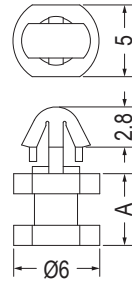

Part No.	A	T	Package
PDC-5.5D	5.5	1.6	2000
PDC-6D	6.0	1.6	
PDC-6.5D	6.5	1.6	
PDC-7D	7.0	1.6	
PDC-13D	13.0	1.2~1.7	
PDC-13.5D	13.5	1.6	
PDC-26D	26.0	1.6	



MOUNTING HOLE Ø3.5
THICKNESS 1.6

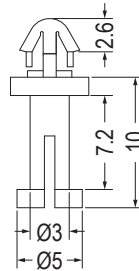

Part No.	Package
MCN-10	1000

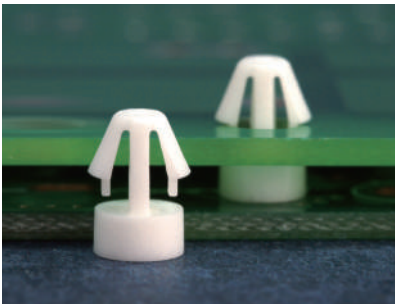

MOUNTING HOLE Ø4.0
THICKNESS: T

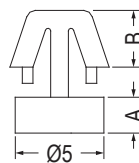

Part No.	A	B	T	Package
MC-2	2.0	3.1	1.2~1.7	2000
MC-2-1.2	2.0	3.5	0.8~1.0	
MC-2.5	2.5	3.65	1.2~1.7	1000

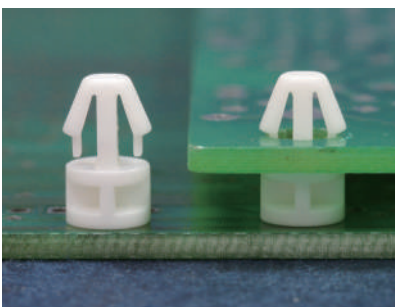

MOUNTING HOLE Ø4.0
THICKNESS 1.2~1.6

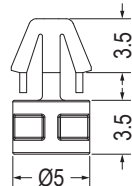

Part No.	Package
MC-3.5-1	1000

MOUNTING HOLE Ø4.0
THICKNESS 1.6

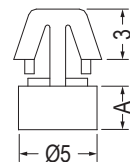

Part No.	A	Package
MC-3	3.0	2000
MC-3.2	3.2	
MC-3.5	3.5	
MC-4	4.0	
MC-5	5.0	

PC板間隔柱 SPACER SUPPORT

用途：支撐PC板，使中間不致震動，載重而凹陷短路。

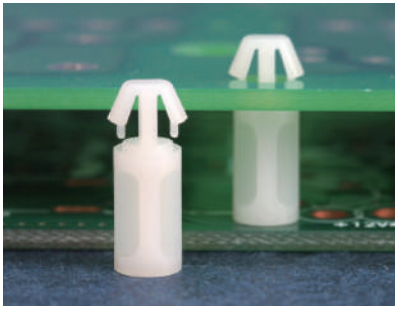

- Material: Nylon 66 (UL)
- Flame Class: 94V-2/94V-0
- Color: Natural/Black
- Unit: mm

P.C.B Ø4.0
THICKNESS 1.6

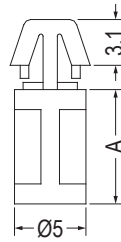

Part No.	A	Package
MC-6	6.3	2000
MC-7	7.0	
MC-7.5	7.5	
MC-8	8.0	
MC-8.5	8.5	
MC-9	9.0	
MC-10	10.0	1000
MC-11.5	11.5	
MC-12	12.7	
MC-16.4	16.4	

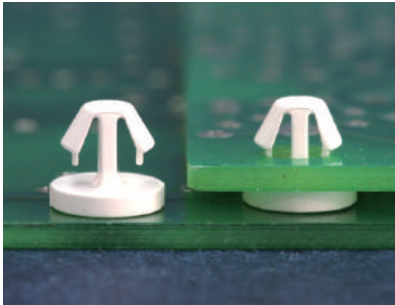

P.C.B Ø4.0
THICKNESS 1.6~1.9

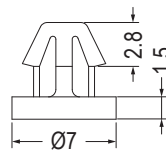

Part No.	Package
MCEA-1.9	1000

P.C.B Ø4.0
THICKNESS 1.6~1.8

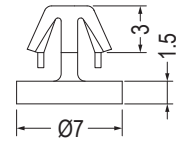

- Material: PC (UL)

Part No.	Package
MCE-1.9	1000

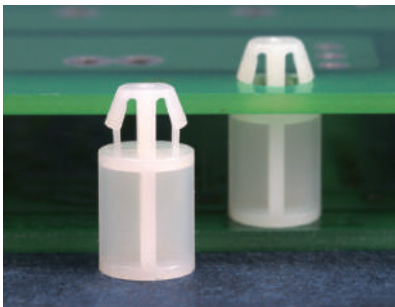

P.C.B Ø4.8
THICKNESS 1.6

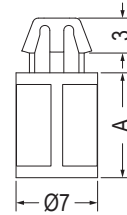

Part No.	A	Package
MCL-9	9.0	2000
MCL-16	16.0	

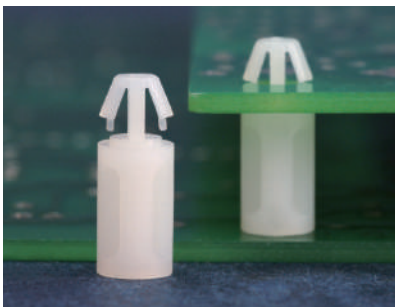

- Material: Nylon 66 (UL)
- Flame Class: 94V-2/94V-0
- Color: Natural/Black
- Unit: mm

P.C.B Ø4.0
THICKNESS 1.6

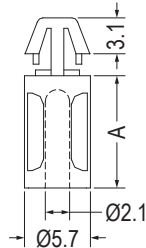

用途：支撐PC板，使中間不致震動，載重而凹陷短路，鐵板可鑽孔用螺絲固定。

Part No.	A	Package
MCH-6	6.35	1000
MCH-10	9.7	
MCH-12	12.7	

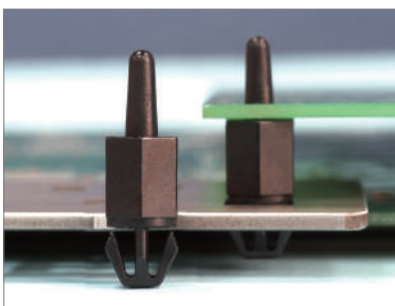

- Material: Nylon 66 (UL)
- Flame Class: 94V-2/94V-0
- Color: Natural/Black
- Unit: mm



用途：PC板直接壓入固定，另一端直接壓入機板固定，省時易拆裝。

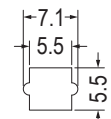
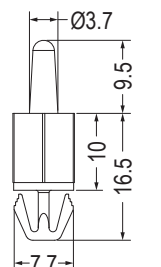

MOUNTING HOLE
THICKNESS 0.8~1.6

Part No.	Package
KVLMMA-10	1000

PC板間隔柱 SPACER SUPPORT

1

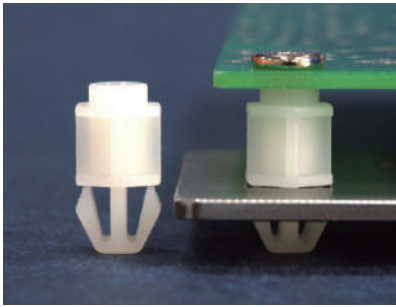

- Material: Nylon 66 (UL)
- Flame Class: 94V-2/94V-0
- Color: Natural/Black
- Unit: mm

用途：固定PC板於機板上，一頭配合螺絲使用，不旋轉。

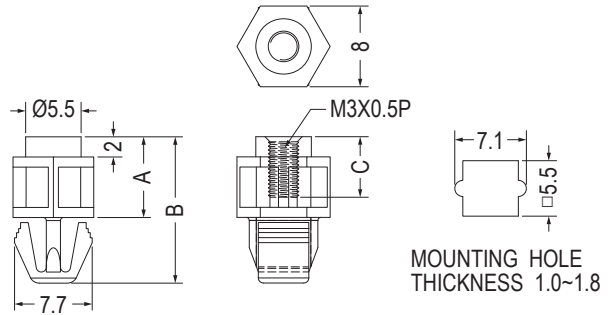

Part No.	A	B	C	Package
KVLM3-5	5.0	11.5	3.0	1000
KVLM3-6	6.0	12.5	4.0	
KVLM3-6.35	6.35	12.85	4.35	
KVLM3-8	8.0	14.5	6.0	
KVLM3-9.5	9.5	16.0	8.0	
KVLM3-10	10.0	16.5	8.0	
KVLM3-12	12.0	18.5	8.0	

Part No.	A	B	C	Package
KVLM3-12.7	12.7	19.2	8.0	1000
KVLM3-15.9	15.9	22.4	8.0	
KVLM3-18	18.0	24.5	8.0	
KVLM3-20	20.0	26.5	8.0	
KVLM3-22	22.0	28.5	8.0	
KVLM3-25.4	25.4	31.9	8.0	

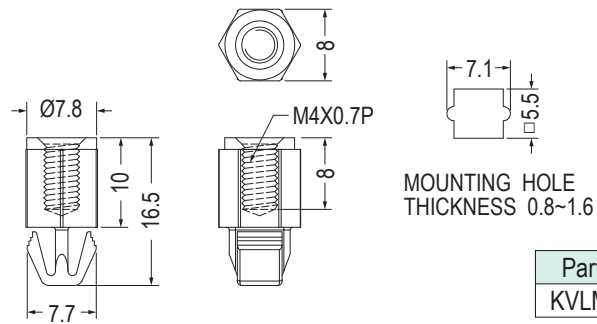
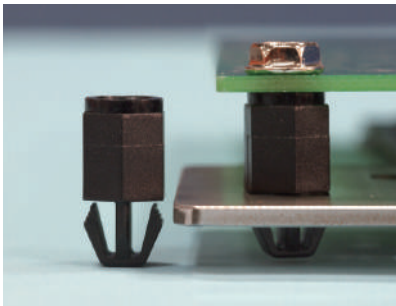

Part No.	Package
KVLM4-10	1000

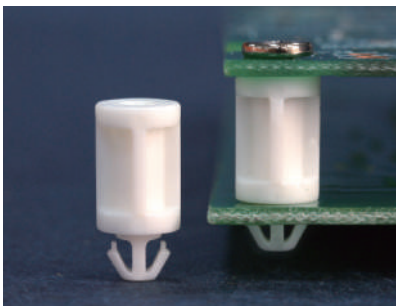

- Material: Nylon 66 (UL)
- Flame Class: 94V-2/94V-0
- Color: Natural/Black
- Unit: mm

用途：固定PC板於機板上，一頭配合螺絲使用。

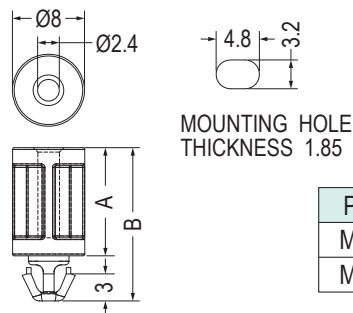

Part No.	A	B	Package
MCIA-12	12.0	17.0	1000
MCIA-16	16.0	21.0	

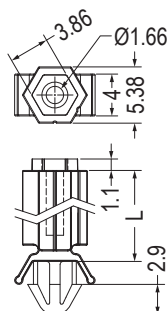
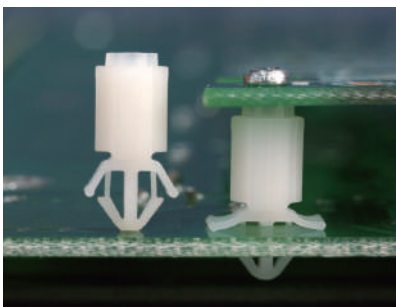

Part No.	L	Package
TCBC-8.7	8.7	1000
TCBC-13.7	13.7	

MOUNTING HOLE Ø4.0 THICKNESS 0.8~1.6

PC板間隔柱 SPACER SUPPORT

用途：固定PC板於機板上，一頭配合自攻螺絲使用。

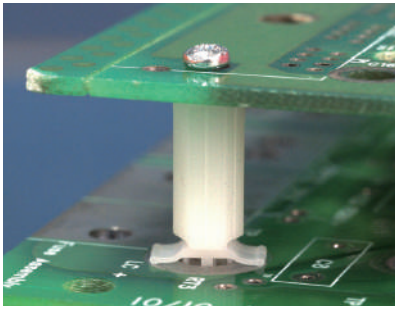

- Material: Nylon 66 (UL)
- Flame Class: 94V-2/94V-0
- Color: Natural/Black
- Unit: mm

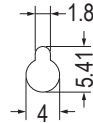
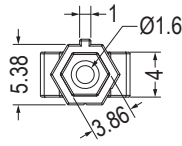

MOUNTING HOLE THICKNESS 0.8

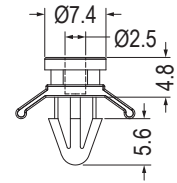

MOUNTING HOLE Ø4.8~Ø5.0 THICKNESS 2.0

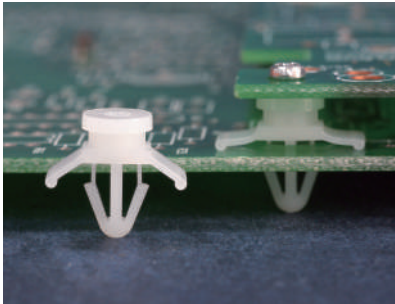
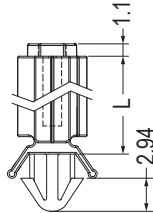

Part No.	L	Package
TCBE-8.7	8.7	1000
TCBE-13.7	13.7	

Part No.	Package
TCBD-4.8	1000

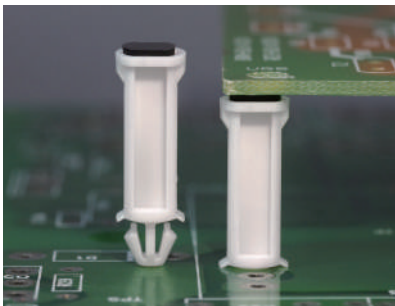

- Material: Nylon 66 (UL)
- Flame Class: 94V-2/94V-0
- Foot Material: Silicon Rubber (UL)
- Foot Flame Class: 94V-0
- Color: Natural/Black
- Unit: mm

用途：固定PC板於機板上，一頭有矽膠墊片支撐PC板，避免震動。

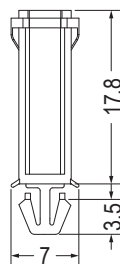

MOUNTING HOLE Ø4.0 THICKNESS 1.6

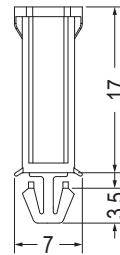

(SPACER SUPPORT)
【TCBH-17】

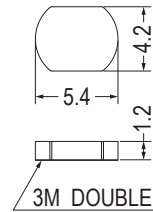

(FOOT)

3M DOUBLE ADHESIVE TAPE

【TF-1752I】



Part No.	Part No.	Package
TCBH-17F	TCBH-17	1000
	TF-1752I	
上述零件可單獨選購		

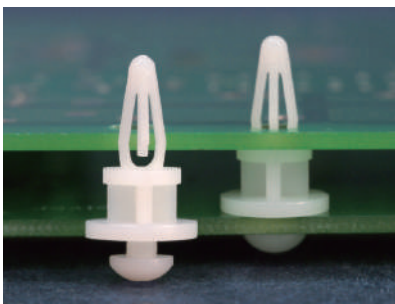

- Material: Nylon 66 (UL)
- Flame Class: 94V-2/94V-0
- Color: Natural/Black
- Unit: mm

用途：一般用於電腦機板固定。

P.C.B Ø4.0 THICKNESS 1.6

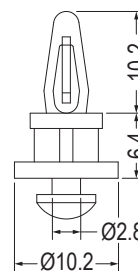

THICKNESS 1.6

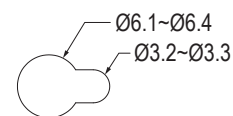

MOUNTING HOLE

Part No.	Package
ACBR-6	1000

PC板間隔柱 SPACER SUPPORT

用途：一般用於電腦機板固定。

1

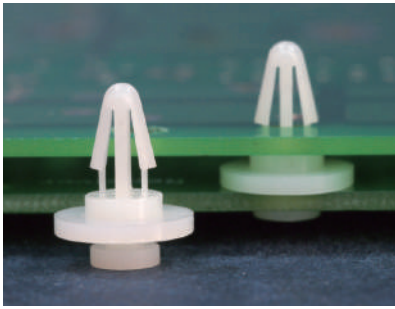

- Material: Nylon 66 (UL)
- Flame Class: 94V-2/94V-0
- Color: Natural/Black
- Unit: mm

P.C.B Ø4.0
THICKNESS 2.7

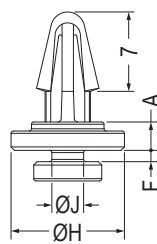

【ACB-2.3】

P.C.B Ø4.0
THICKNESS 1.6~2.0

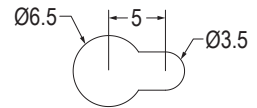
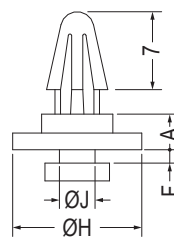

MOUNTING HOLE

Part No.	A	F	H	J	Package
ACB-2.3	2.5	1.0	10.0	2.8	1000
ACB-2.5	2.5	1.4	11.5	2.8	
ACB-3	3.2	1.2	11.6	3.2	

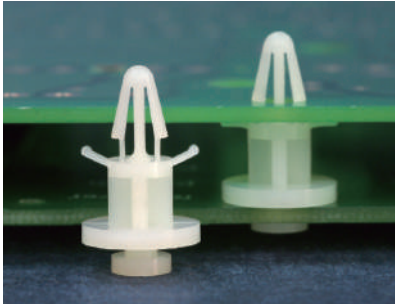

P.C.B Ø4.0
THICKNESS: T

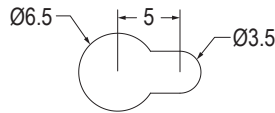
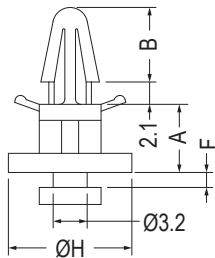

MOUNTING HOLE

Part No.	A	B	F	H	T	Package
ACB-5	5.0	7.0	1.3	11.7	1.6	1000
ACB-6	6.3	7.0	1.3	11.6	1.6	
ACB-8	8.0	7.0	1.4	11.6	1.6	
ACB-60	60.0	7.3	2.8	11.3	1.2~1.7	250
ACB-68	68.0	7.3	1.3	11.3	1.6	
ACB-74	74.0	7.3	1.3	11.3	1.6	

P.C.B Ø4.0
THICKNESS 1.6

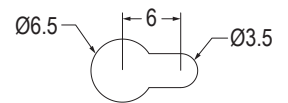
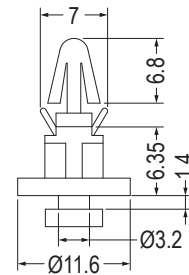

MOUNTING HOLE

Part No.	Package
MCB-6	500

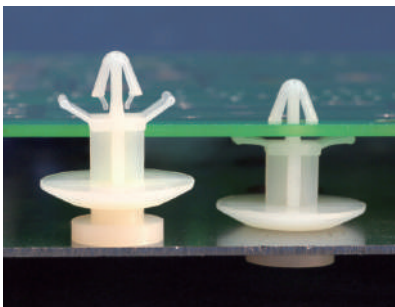

P.C.B Ø4.5
THICKNESS 1.2~2.0

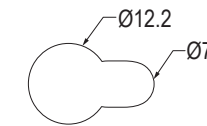
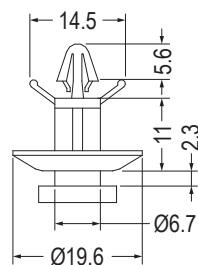

MOUNTING HOLE

Part No.	Package
MBC-11	500

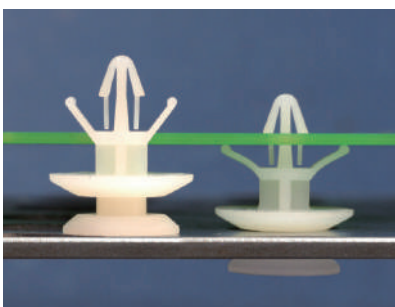

P.C.B Ø4.5~Ø4.8
THICKNESS 0.8~2.5

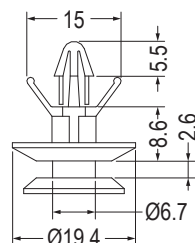

MOUNTING HOLE

Part No.	Package
MBD-10	500

PC板間隔柱 SPACER SUPPORT

用途：機板部份用鐵板自攻螺絲固定，另一頭直接壓入PC板。

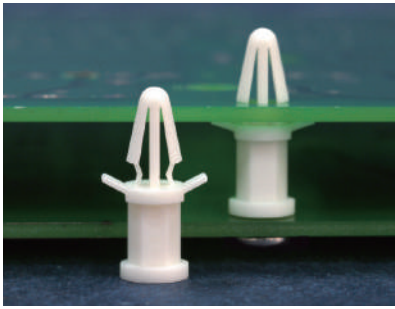

- Material: Nylon 66 (UL)
- Flame Class: 94V-2/94V-0
- Color: Natural/Black
- Unit: mm

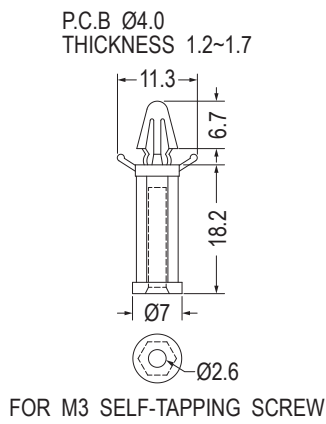

Part No.	Package
TCBS-18	1000

P.C.B Ø4.0
THICKNESS 1.2~1.9

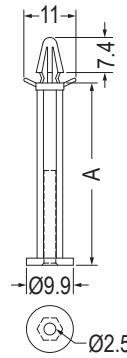

【 TCBS-38.5 】

FOR M3 SELF-TAPPING SCREW

P.C.B Ø4.0
THICKNESS 1.2~1.7

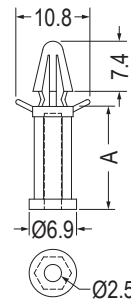

Part No.	A	Package
TCBS-5	5.0	1000
TCBS-6A	6.0	
TCBS-6	6.35	
TCBS-7	7.0	
TCBS-9.5	9.5	
TCBS-10	10.0	
TCBS-12.5	12.5	
TCBS-15	15.0	
TCBS-20	20.0	
TCBS-24.5	24.5	
TCBS-25	25.0	
TCBS-26	26.0	
TCBS-30	30.0	
TCBS-35	35.0	
TCBS-38.5	38.5	

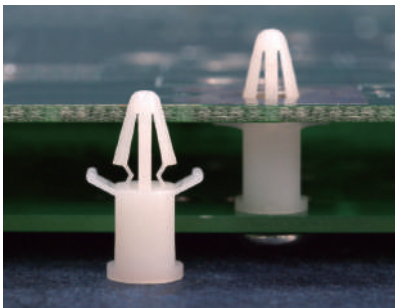

THICKNESS 1.2~1.7

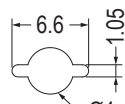
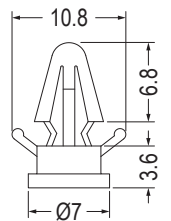

MOUNTING HOLE

THICKNESS 1.2~1.7

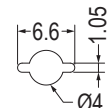
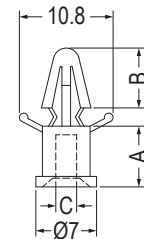

MOUNTING HOLE

FOR SCREW

Part No.	Package
TCBT-3.6	1000

Part No.	A	B	C	Screw	Package
TCBT-7	7.0	6.9	2.4	4-40 UNC	1000
TCBT-7.7	7.7	5.9	2.6	M3	
TCBT-8.5	8.5	6.9	2.6	M3	
TCBT-16	16.0	6.9	2.4	4-40 UNC	

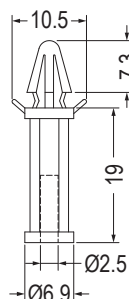
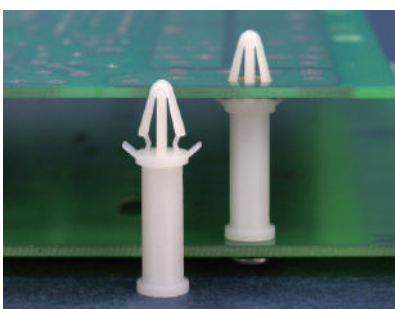

P.C.B THICKNESS 1.2~1.9

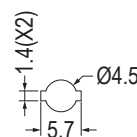

MOUNTING HOLE

FOR M3 SCREW

Part No.	Package
TCBT-19	1000

PC板間隔柱 SPACER SUPPORT

用途：支撐PC板，使中間不致震動，載重而凹陷短路。

1

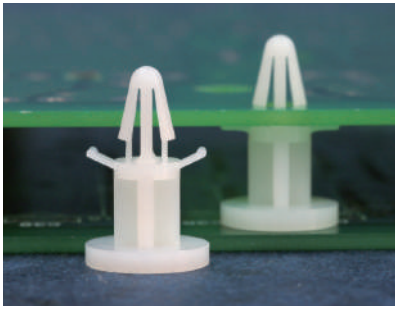

- Material: Nylon 66 (UL)
- Flame Class: 94V-2/94V-0
- Color: Natural/Black
- Unit: mm

MOUNTING HOLE Ø4.0
THICKNESS 1.2~1.7

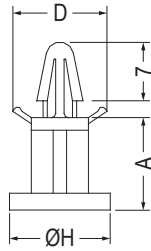

Part No.	A	D	H	Package
MBS-6	6.4	11.4	11.8	1000
MBS-8	8.0	11.4	11.8	
MBS-8.9S	8.9	11.1	8.0	
MBS-8.9	8.9	11.1	11.9	
MBS-9.5L	9.5	11.4	20.0	
MBS-10	10.0	11.4	12.0	
MBS-11	11.0	11.4	12.0	500
MBS-14	14.0	11.4	12.0	250
MBS-74	74.0	10.4	11.3	

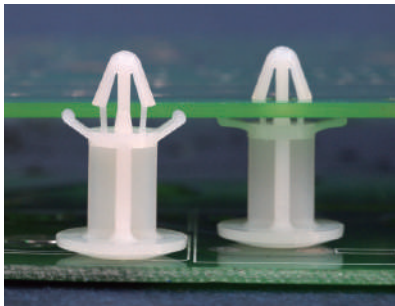

MOUNTING HOLE Ø4.5
THICKNESS 1.2~1.7

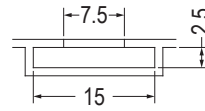
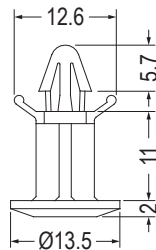

MOUNTING HOLE

Part No.	Package
MTD-11	500

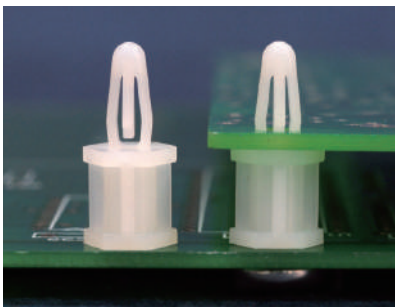

- Material: Nylon 66 (UL)
- Flame Class: 94V-2/94V-0
- Color: Natural/Black
- Unit: mm

用途：機板部份用M3.5鐵板自攻螺絲固定，另一頭直接壓入PC板。

MOUNTING HOLE Ø4.0
THICKNESS 1.6

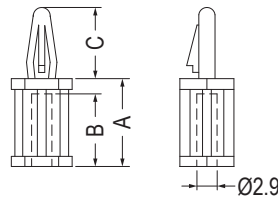

Part No.	A	B	C	Package
BS-6	6.4	4.8	10.2	1000
BS-9	9.5	8.0	10.2	
BS-12	12.7	11.0	10.2	
BS-14	14.0	12.7	10.2	
BS-15S	15.0	13.0	10.4	
BS-15	15.9	13.0	10.2	
BS-19	19.1	16.2	10.2	
BS-22	22.2	19.4	10.2	
BS-25	25.4	24.0	10.2	
BS-28	28.6	25.9	10.2	
BS-29	29.0	25.9	10.2	

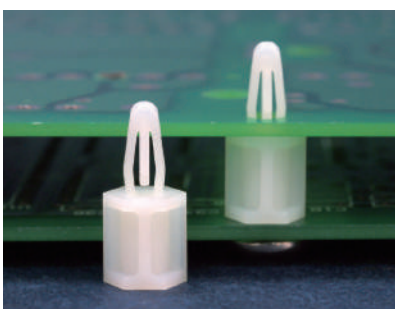

MOUNTING HOLE Ø4.0
THICKNESS 2.0

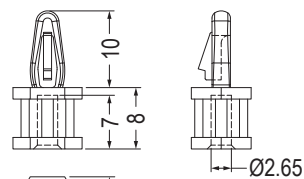

Part No.	Package
BS-8	1000

MOUNTING HOLE Ø4.0
THICKNESS 1.6

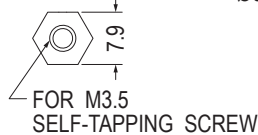
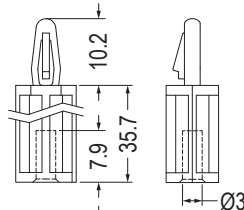

Part No.	Package
★BS-35.7	500

MOUNTING HOLE Ø4.0
THICKNESS 2.0

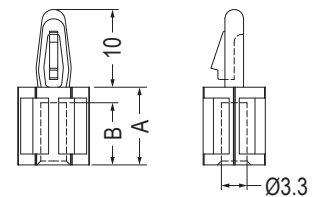

Part No.	A	B	Package
BS-10-1	10.0	8.0	1000
BS-20-1	20.0	12.0	1000

PC板間隔柱 SPACER SUPPORT

用途：機板部份用M3鐵板自攻螺絲固定，另一頭直接壓入PC板。

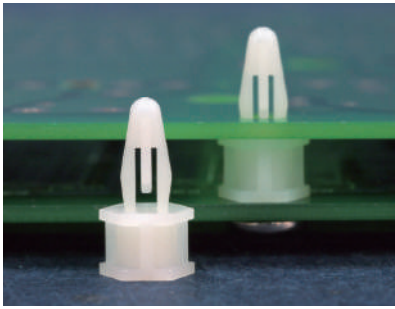

- Material: Nylon 66 (UL)
- Flame Class: 94V-2/94V-0
- Color: Natural/Black
- Unit: mm

MOUNTING HOLE Ø4.0
THICKNESS 1.2~1.7

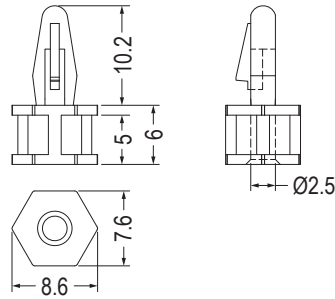

Part No.	Package
BSB-6	1000

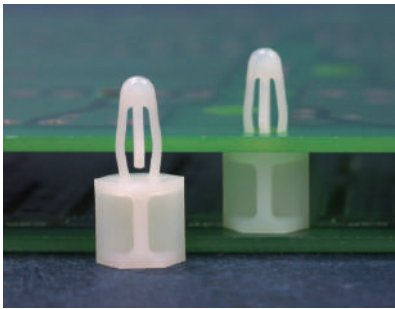

- Material: Nylon 66 (UL)
- Flame Class: 94V-2/94V-0
- Color: Natural/Black
- Unit: mm

用途：支撐PC板，使中間不致震動，載重而凹陷短路。

MOUNTING HOLE Ø4.2
THICKNESS 1.6

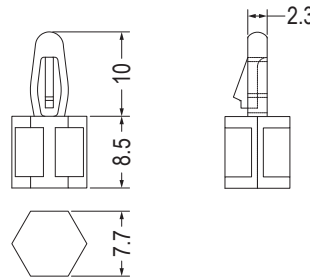

Part No.	Package
BSB-8.5	1000

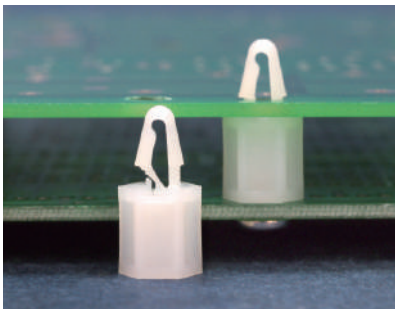

- Material: Nylon 66 (UL)
- Flame Class: 94V-2/94V-0
- Color: Natural/Black
- Unit: mm

用途：機板部份用M3.5鐵板自攻螺絲固定，另一頭直接壓入PC板。

MOUNTING HOLE Ø4.0
THICKNESS 1.6~2.0

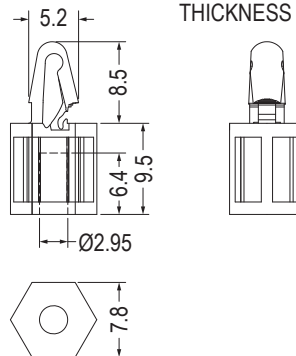

Part No.	Package
BSCL-9.5	1000

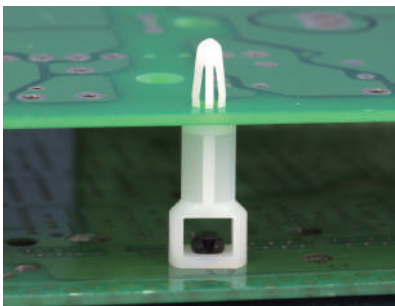

- Material: Nylon 66 (UL)
- Flame Class: 94V-2/94V-0
- Color: Natural/Black
- Unit: mm

用途：一端配合SR4系列鉚釘固定於機板上，一端固定於PC板上。

MOUNTING HOLE Ø4.0
THICKNESS 1.6

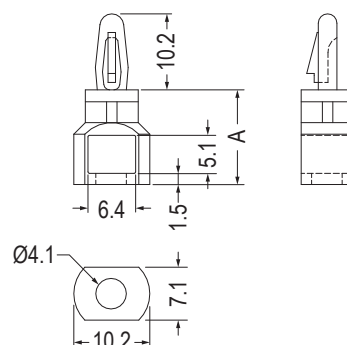

Part No.	A	Package
SRLCB-9	9.5	1000
SRLCB-11	11.1	
SRLCB-12	12.7	
SRLCB-15	15.9	
SRLCB-19.1	19.1	
SRLCB-22	22.2	
SRLCB-25	25.4	

PC板間隔柱 SPACER SUPPORT

用途：一端配合SR4系列鉚釘固定於機板上，一端固定於PC板上。

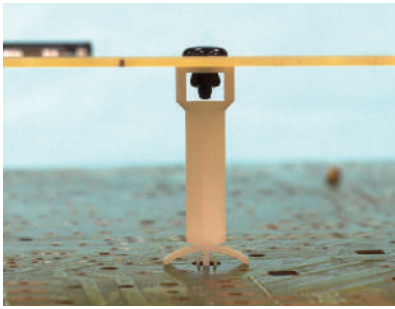

- Material: Nylon 66 (UL)
- Flame Class: 94V-2/94V-0
- Color: Natural/Black
- Unit: mm

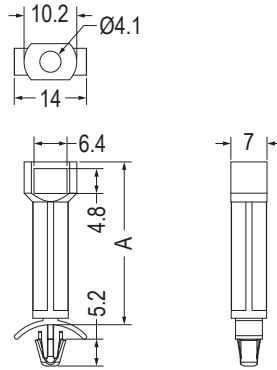
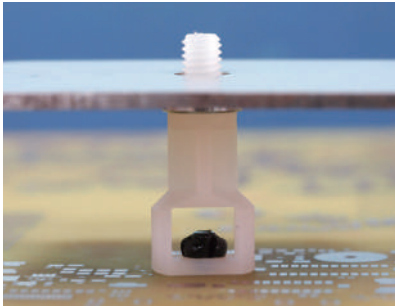

P.C.B Ø4.75~Ø4.8
THICKNESS 0.8~2.0

Part No.	A	Package
SRLA-29.5	29.5	1000
SRLA-31.5	31.5	

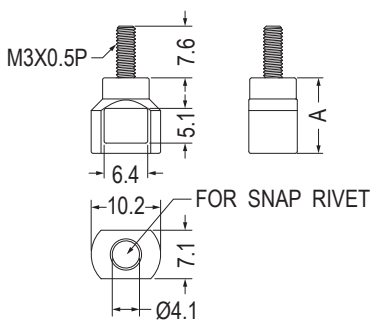

Part No.	A	Package
TCEB3-9.5	9.5	1000
TCEB3-11.1	11.1	

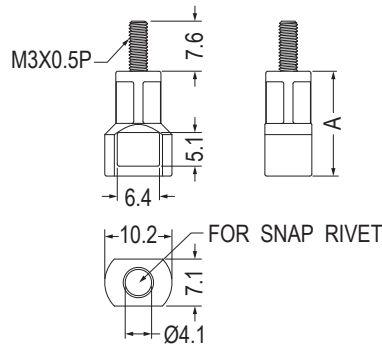

Part No.	A	Package
TCEB3-12.7	12.7	1000
TCEB3-15.9	15.9	
TCEB4-19.1	19.1	
TCEB4-22.2	22.2	
TCEB3-25.4	25.4	

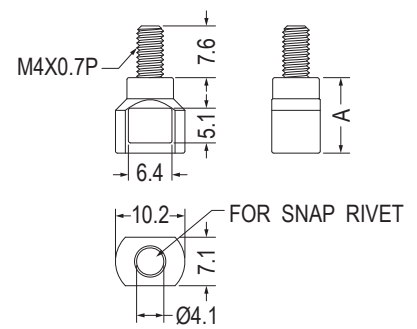

Part No.	A	Package
TCEB4-9.5	9.5	1000
TCEB4-11.1	11.1	

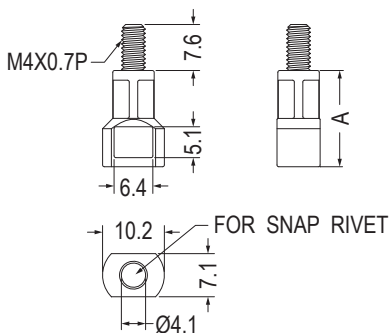

Part No.	A	Package
TCEB4-12.7	12.7	1000
TCEB4-15.9	15.9	
TCEB4-19.1	19.1	
TCEB4-22.2	22.2	
TCEB4-25.4	25.4	

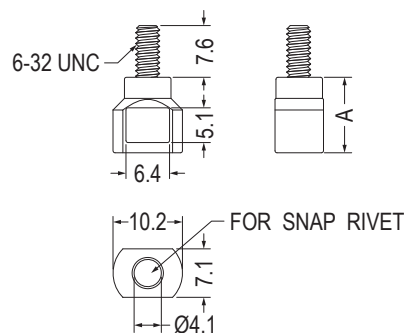

Part No.	A	Package
TCEB632-9.5	9.5	1000
TCEB632-11.1	11.1	

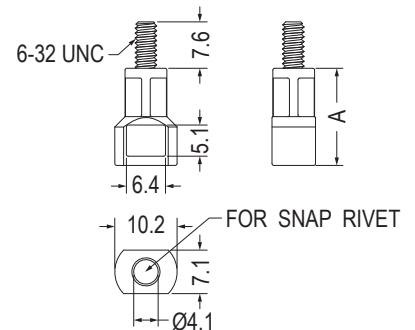

Part No.	A	Package
TCEB632-12.7	12.7	1000
TCEB632-15.9	15.9	
TCEB632-19.1	19.1	
TCEB632-22.2	22.2	
TCEB632-25.4	25.4	

PC板間隔柱 SPACER SUPPORT

用途：機板部份用螺絲固定，另一頭直接壓入PC板。

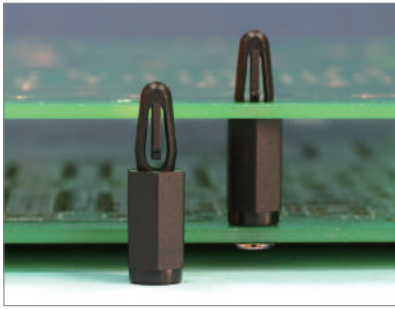

- Material: Nylon 66 (UL)
- Flame Class: 94V-2/94V-0
- Color: Natural/Black
- Unit: mm

MOUNTING HOLE Ø4.0
THICKNESS 1.6

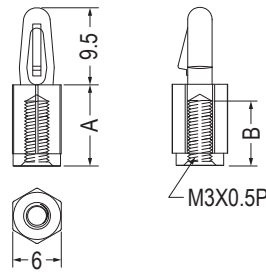

Part No.	A	B	Package
BSCB-10	10.0	8.0	1000
BSCB-12	12.0	8.0	
BSCB-15	15.0	10.0	
BSCB-25	25.0	10.0	

MOUNTING HOLE Ø4.0
THICKNESS 1.8

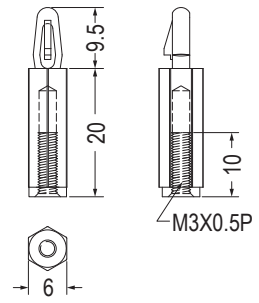

Part No.	Package
BSCB-20	1000

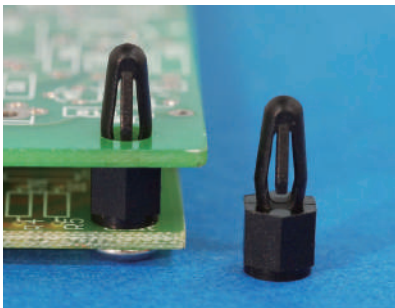

MOUNTING HOLE Ø4.0
THICKNESS 2.0

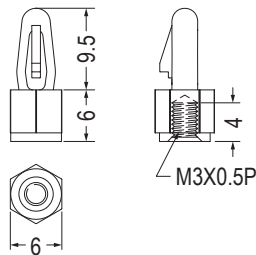

Part No.	Package
BSCB-6	1000

MOUNTING HOLE Ø4.0
THICKNESS 1.6

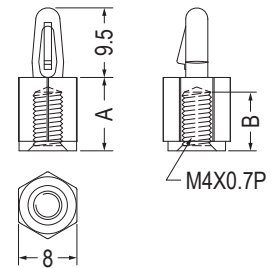

Part No.	A	B	Package
BSCB4-6	6.0	4.0	1000
BSCB4-8	8.0	6.0	
BSCB4-10	10.0	8.0	



- Material: Nylon 66 (UL)
- Flame Class: 94V-2/94V-0
- Color: Natural/Black
- Unit: mm

用途：機板部份用6-32鐵板自攻螺絲固定，另一頭直接壓入PC板。

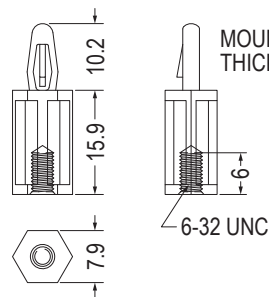

Part No.	Package
BSB632-15.9	1000

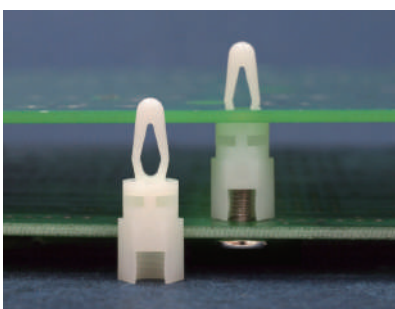

- Material: Nylon 66 (UL)
- Flame Class: 94V-2/94V-0
- Color: Natural/Black
- Unit: mm

用途：機板部份用螺絲固定，另一頭直接壓入PC板。

MOUNTING HOLE Ø4.0
THICKNESS 1.57

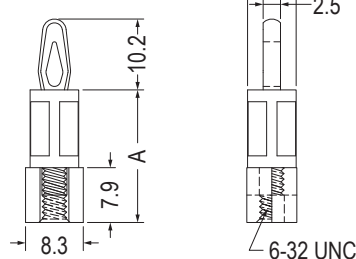

Part No.	A	Package
BSC632-9.5	9.5	1000
BSC632-12.7	12.7	
BSC632-15.9	15.9	
BSC632-19.1	19.1	
BSC632-22.2	22.2	
BSC632-25.4	25.4	

PC板間隔柱 SPACER SUPPORT

用途：機板部份用螺絲固定，另一頭直接壓入PC板。

1

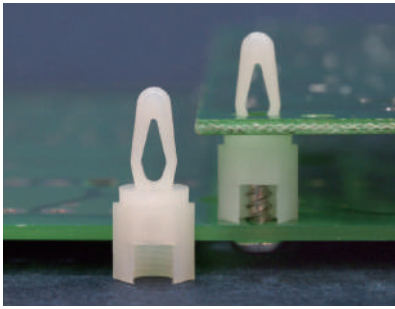

- Material: Nylon 66 (UL)
- Flame Class: 94V-2/94V-0
- Color: Natural/Black
- Unit: mm

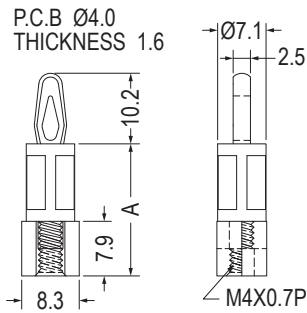

Part No.	A	Package
BSCM4-9.5	9.5	1000
BSCM4-12.7	12.7	
BSCM4-15.9	15.9	
BSCM4-19.1	19.1	
BSCM4-22.2	22.2	
BSCM4-25.4	25.4	

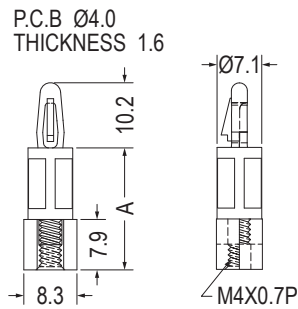
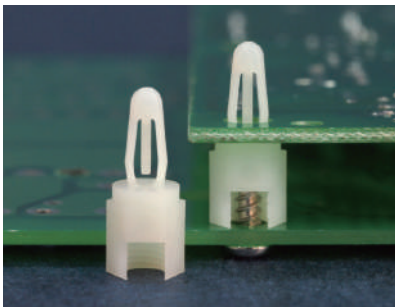

Part No.	A	Package
BSDM4-9.5	9.5	1000
BSDM4-12.7	12.7	
BSDM4-15.9	15.9	
BSDM4-19.1	19.1	
BSDM4-22.2	22.2	
BSDM4-25.4	25.4	

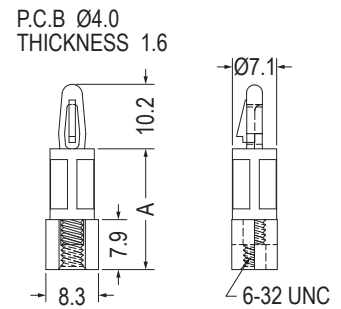

Part No.	A	Package
BSD632-9.5	9.5	1000
BSD632-12.7	12.7	
BSD632-15.9	15.9	
BSD632-19.1	19.1	
BSD632-22.2	22.2	
BSD632-25.4	25.4	

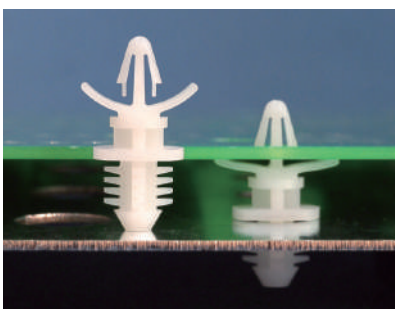

- Material: Nylon 66 (UL)
- Flame Class: 94V-2/94V-0
- Color: Natural/Black
- Unit: mm

用途：一端固定於木頭或音箱上，另一端固定於PC板上。

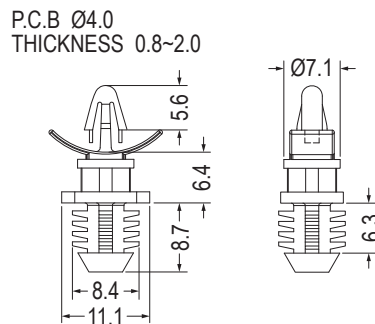

HOLE IN PANEL Ø7.9 THICKNESS 6.4

Part No.	Package
WBHC-6.4	1000

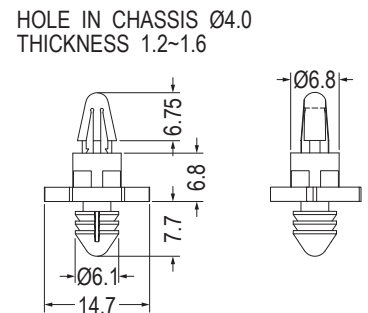

HOLE IN WOODENWARE Ø6.0 THICKNESS 7.0

Part No.	Package
ACBW-6.8	1000

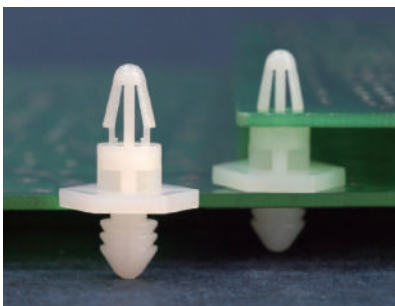

PC板間隔柱 SPACER SUPPORT

用途：一端固定於木頭或音箱上，另一端固定於PC板上。

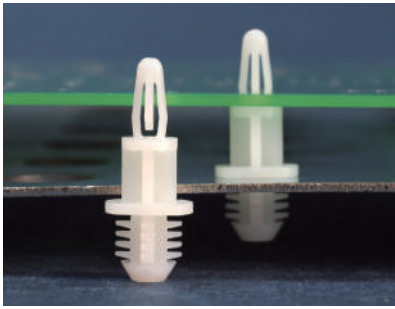

- Material: Nylon 66 (UL)
- Flame Class: 94V-2/94V-0
- Color: Natural/Black
- Unit: mm

P.C.B Ø4.0
THICKNESS 1.2~1.7

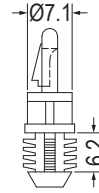
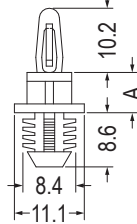

HOLE IN PANEL Ø7.9
THICKNESS 6.4

Part No.	A	Package
WBH-5	4.8	1000
WBH-6	6.4	
WBH-9	9.5	
WBH-11	11.1	
WBH-12	12.7	
WBH-16	15.9	
WBH-19	19.1	
WBH-22	22.2	
WBH-25	25.4	

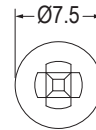
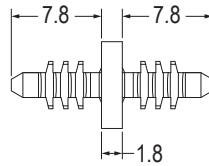
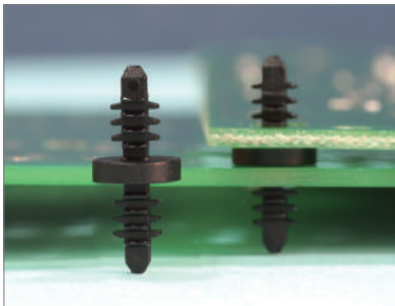

MOUNTING HOLE Ø4.0
THICKNESS 2.6~6.3

Part No.	Package
WBHB-1.8	1000



- Material: Nylon 66 (UL)
- Flame Class: 94V-2/94V-0
- Color: Natural/Black
- Unit: mm

用途：一端固定於機板上，另一端支撐PC板，避免下陷造成短路，PC板免鑽孔。

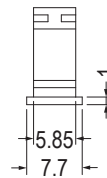
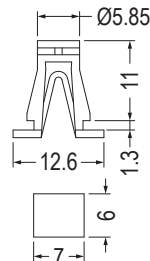

MOUNTING HOLE

Part No.	Package
PAA-11	1000

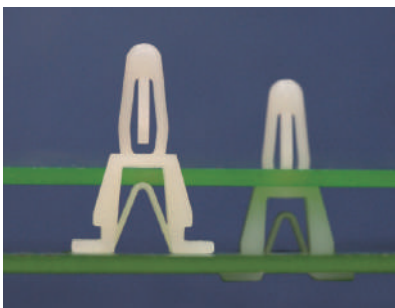

- Material: Nylon 66 (UL)
- Flame Class: 94V-2/94V-0
- Color: Natural/Black
- Unit: mm

用途：固定PC板於機板上，不會突出機板底部，外觀美麗。

P.C.B Ø4.0
THICKNESS 0.8~1.7

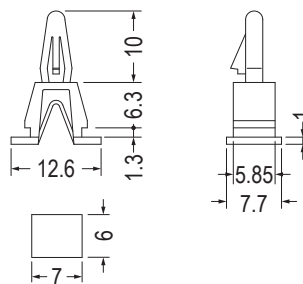

MOUNTING HOLE

Part No.	Package
PCC-6	2000

P.C.B Ø4.0
THICKNESS 1.2~1.7

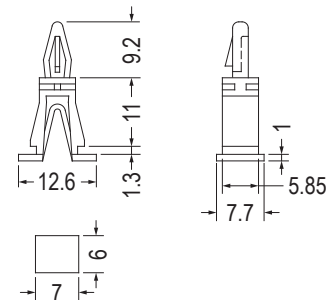

MOUNTING HOLE

Part No.	Package
PCC-11	1000

PC板間隔柱 SPACER SUPPORT

用途：支撐PC板，使中間不致震動，載重而凹陷短路，吸震力強。

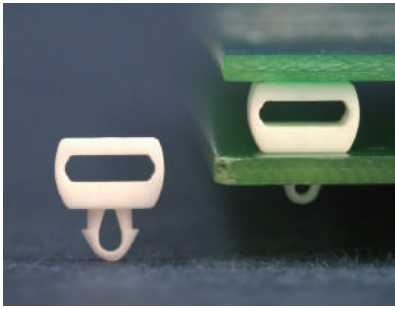

- Material: Nylon 66 (UL)
- Flame Class: 94V-2/94V-0
- Color: Natural/Black
- Unit: mm

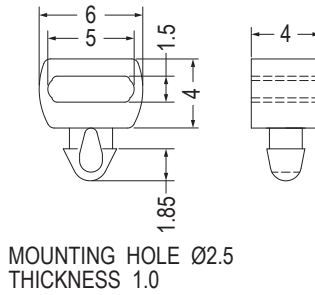

Part No.	Package
LIJ-4	2000

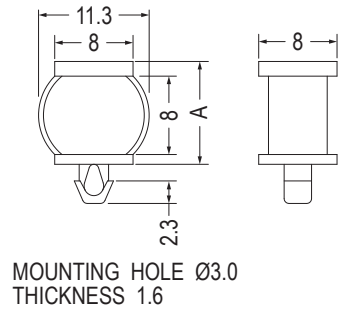

Part No.	A	Package
LIO-10	10.0	2000
LIO-10.5	10.5	

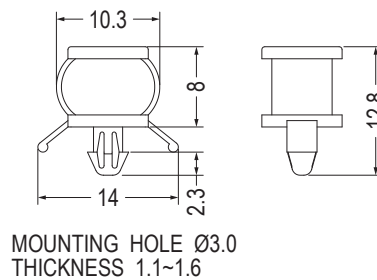
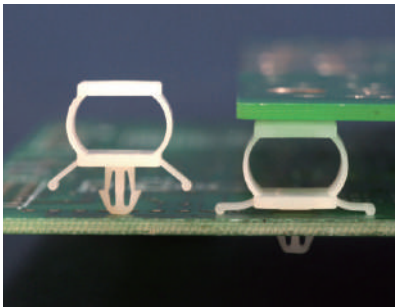

Part No.	Package
LIO-8	2000



- Material: Nylon 66 (UL)
- Flame Class: 94V-2/94V-0
- Color: Natural/Black
- Unit: mm

用途：配合螺絲固定電漿面板於機殼上，可靠不脫落。

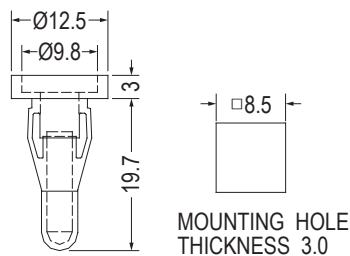

Part No.	Package
YES-3	500

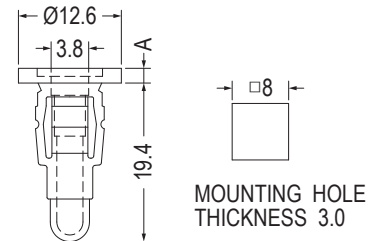

Part No.	A	Package
YES-08	0.8	500
YES-32	3.2	
YES-48	4.8	

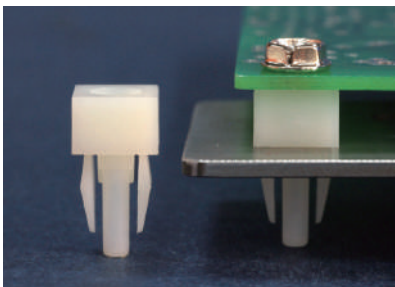

- Material: Nylon 66 (UL)
- Flame Class: 94V-2/94V-0
- Color: Natural/Black
- Unit: mm

用途：可搭配自攻牙螺絲用於PC板之固定。

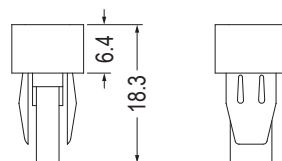
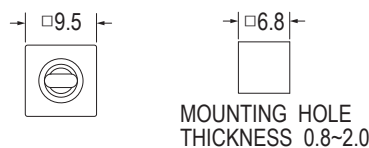

Part No.	Package
ES-1	2000

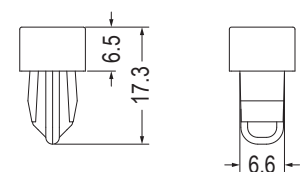

Part No.	Package
ES-2	1000

PC板間隔柱 SPACER SUPPORT

用途：配合螺絲用於PC板之固定或當螺絲固定座。

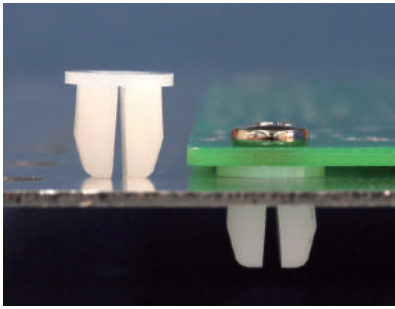

- Material: Nylon 66 (UL)
- Flame Class: 94V-2/94V-0
- Color: Natural/Black
- Unit: mm

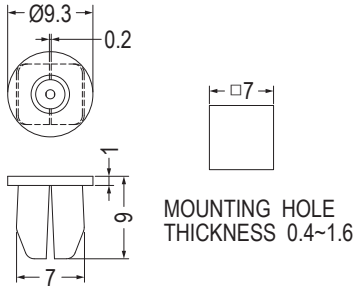

Part No.	Package
ESS-1	1000

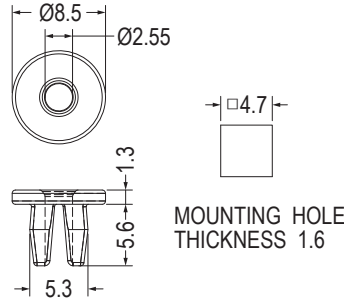

Part No.	Package
ESS-3	1000

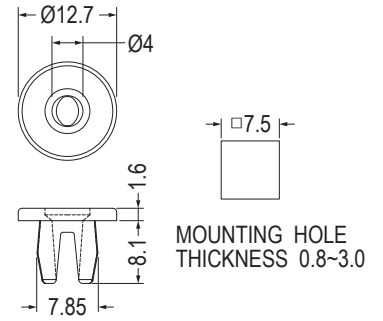

Part No.	Package
ESS-4	1000

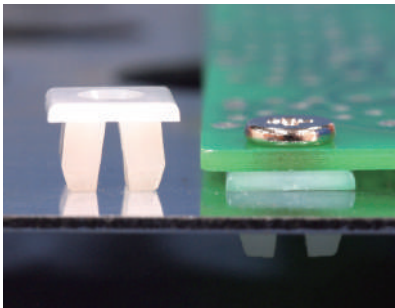

- Material: Nylon 66 (UL)
- Flame Class: 94V-2/94V-0
- Color: Natural/Black
- Unit: mm

用途：配合螺絲用於PC板之固定。

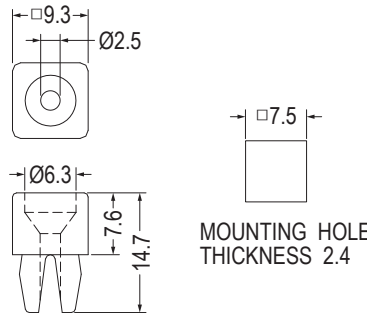

Part No.	Package
ESS-7.6	1000

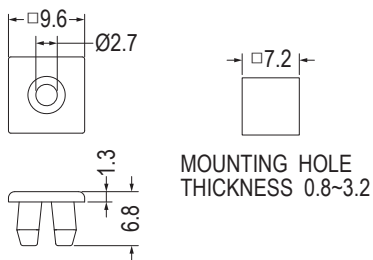

Part No.	Package
ESS-2	1000

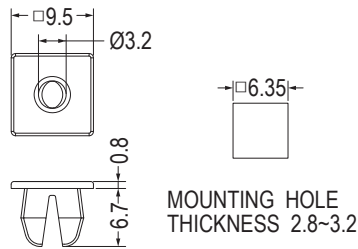

Part No.	Package
ESS-5	1000

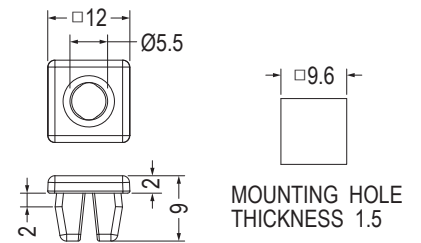

Part No.	Package
ESS6-2.5	1000

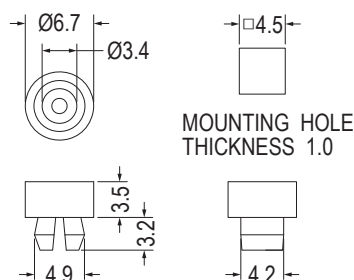
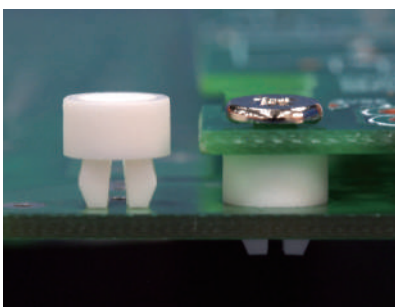

Part No.	Package
ETSA-3.5	1000

PC板間隔柱 SPACER SUPPORT

用途：配合螺絲用於PC板之固定。

1

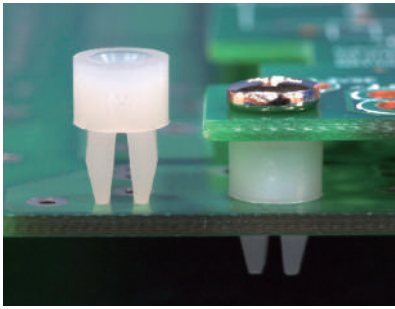

- Material: Nylon 66 (UL)
- Flame Class: 94V-2/94V-0
- Color: Natural/Black
- Unit: mm

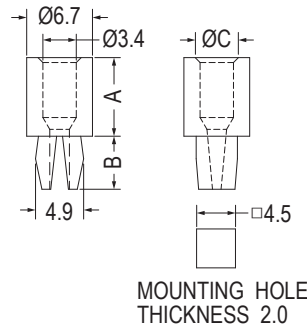

Part No.	A	B	C	Package
ETS-3	3.0	5.4	4.4	2000
ETS-3-1	3.0	5.4	5.0	
ETS-3.2	3.2	5.4	4.4	
ETS-3.2-1	3.2	5.4	5.0	
ETS-3.2-2	3.2	4.0	5.0	
ETS-3.4	3.4	5.4	4.4	
ETS-3.6	3.6	5.4	5.0	
ETS-4.6	4.6	5.4	4.4	
ETS-4.8	4.8	5.4	4.4	
ETS-6.3	6.3	5.4	4.4	
ETSS-6.5	6.5	4.0	4.4	
ETS-7M	7.0	4.0		
ETS-7	7.0	5.0		
ETS-8	8.0	5.4	4.4	
ETS-10	10.0	5.4	4.4	
ETS-12	12.7	5.4	4.4	
ETS-16	15.9	5.4	4.4	
ETS-19	19.1	5.4	4.4	

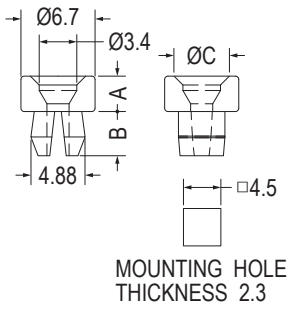

【 ETS-3.2-2 】

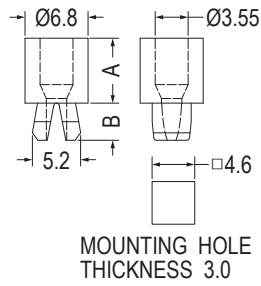

【 ETS-7M 】

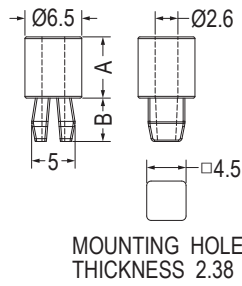

【 ETS-7 】

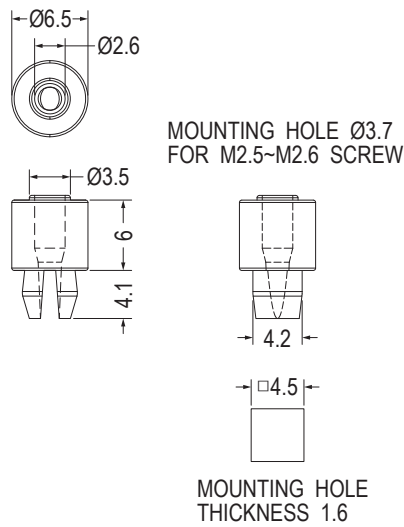
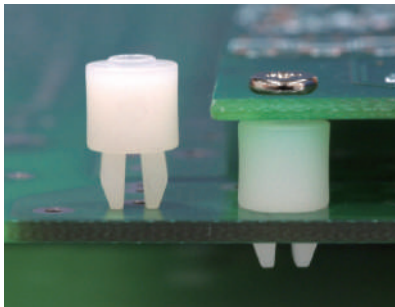

Part No.	Package
ETSB-6	1000

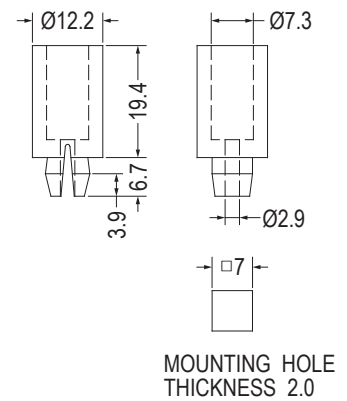

Part No.	Package
ESS-19	1000

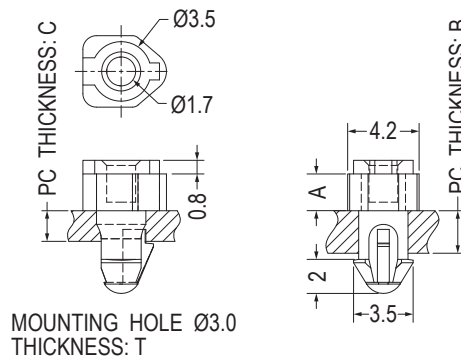
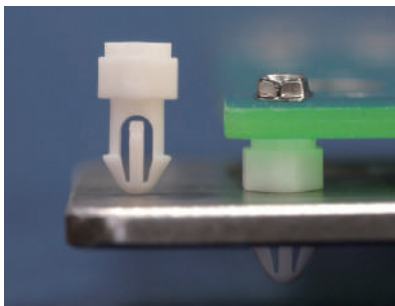
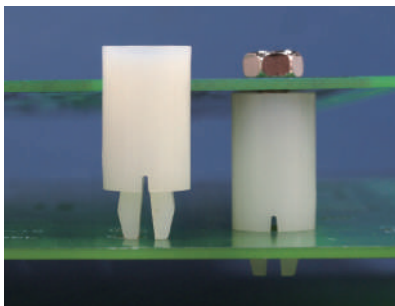

Part No.	A	B	C	T	Package
BSE-2.2	2.16	2.5	1.6	1.6~2.5	1000
BSE-2.2L	2.2	3.3	2.0	1.7~3.05	

PC板間隔柱 SPACER SUPPORT

用途：固定PC板於機板上，PC板用螺絲固定，易拆卸。

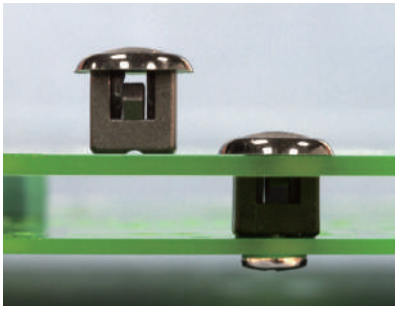

- Material: Nylon 66 (UL)
- Flame Class: 94V-2/94V-0
- Color: Natural/Black
- Unit: mm

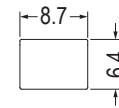
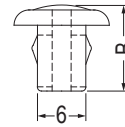
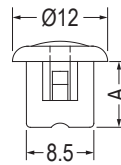

MOUNTING HOLE THICKNESS 0.8-2.0

Part No.	A	B	Package
LHC-8	8.4	10.8	1000
LHC-12	12.5	14.9	

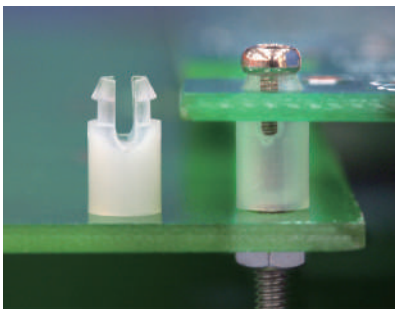

- Material: Nylon 66 (UL)
- Flame Class: 94V-2/94V-0
- Color: Natural/Black
- Unit: mm

用途：快速固定PC板於機板上，如配合螺絲可將PC板固定於木板上。

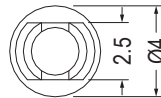

P.C.B Ø3.0 THICKNESS: T

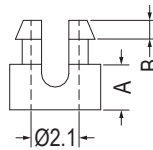

FOR M2 SCREW

P.C.B Ø3.0 THICKNESS 1.3

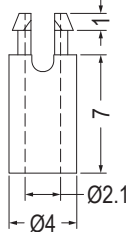

FOR M2 SCREW

Part No.	Package
SS3-7(1.3)	1000

Part No.	A	B	T	Package
SS1-2	2.0	1.2	0.8~1.0	2000
SS1-2.5	2.5	1.2	0.8~1.0	
SS1-3	3.0	1.2	0.8~1.0	
SS1-3.5	3.5	1.2	0.8~1.0	
SS1-4	4.0	1.2	0.8~1.0	
SS1-4.5	4.5	1.2	0.8~1.0	
SS1-5	5.0	1.2	0.8~1.0	
SS1-5.5	5.5	1.2	0.8~1.0	
SS1-6	6.0	1.2	0.8~1.0	
SS1-2L	2.0	1.0	1.6	
SS1-2.5L	2.5	1.0	1.6	
SS1-3L	3.0	1.0	1.6	

Part No.	A	B	T	Package
SS1-2S	2.0	0.5	0.8~1.0	2000
SS1-2.5S	2.5	0.5	0.8~1.0	
SS1-3S	3.0	0.5	0.8~1.0	
SS1-3.5S	3.5	0.5	0.8~1.0	
SS1-4S	4.0	0.5	0.8~1.0	
SS1-4.5S	4.5	0.5	0.8~1.0	
SS1-5S	5.0	0.5	0.8~1.0	
SS1-5.5S	5.5	0.5	0.8~1.0	
SS1-6S	6.0	0.5	0.8~1.0	
SS1-2L	2.0	1.0	1.6	
SS1-2.5L	2.5	1.0	1.6	
SS1-3L	3.0	1.0	1.6	
SS1-3.5L	3.5	1.0	1.6	
SS1-4L	4.0	1.0	1.6	
SS1-4.5L	4.5	1.0	1.6	
SS1-5L	5.0	1.0	1.6	
SS1-5.5L	5.5	1.0	1.6	
SS1-6L	6.0	1.0	1.6	
SS1-8L	8.0	1.0	1.6	
SS1-9L	9.0	1.0	1.6	

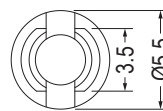
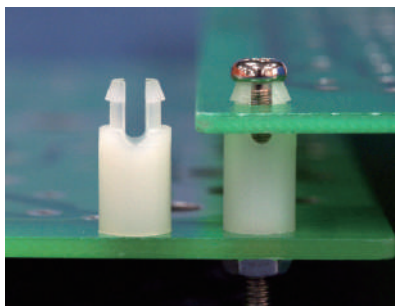

P.C.B Ø4.0 THICKNESS: T

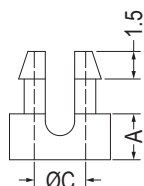

FOR SCREW

Part No.	A	C	T	Screw	Package
SS2-2.5U	2.5	2.1	1.6~1.8	M2	2000
SS2-2.5S	2.5	2.7	1.6	M2.6	
SS2-3S	3.0	2.7	1.6	M2.6	
SS2-4S	4.0	2.7	1.6	M2.6	
SS2-5S	5.0	2.7	1.6	M2.6	
SS2-6S	6.0	2.7	1.6	M2.6	
SS2-2.5	2.5	2.8	1.6~1.8	M2.6	
SS2-3	3.0	2.8	1.6~1.8	M2.6	
SS2-4	4.0	2.8	1.6~1.8	M2.6	
SS2-5	5.0	2.8	1.6~1.8	M2.6	
SS2-5.4	5.4	2.8	1.6~1.8	M2.6	
SS2-6	6.0	2.8	1.6~1.8	M2.6	
SS2-8	8.0	2.8	1.6~1.8	M2.6	
SS2-9.5	9.5	2.8	1.6~1.8	M2.6	

PC板間隔柱 SPACER SUPPORT

用途：快速固定PC板於機板上，如配合螺絲可將PC板固定於木板上。

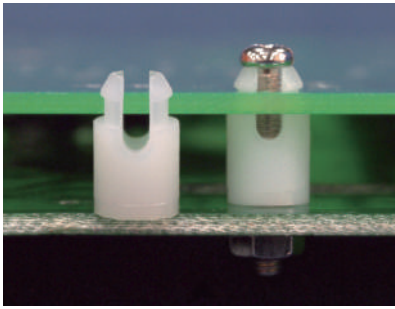

- Material: Nylon 66 (UL)
- Flame Class: 94V-2/94V-0
- Color: Natural/Black
- Unit: mm

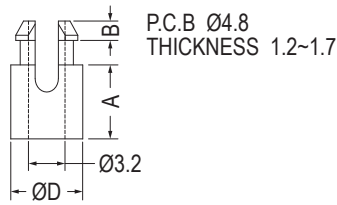

FOR M3 SCREW

Part No.	A	B	D	Package
SS-7	7.0	1.5	6.5	1000
SS-7.4	7.4	1.7	6.5	
SS-8	7.9	1.5	6.4	
SS-10	9.5	1.5	6.4	
SS-10A	9.5	1.7	6.5	
SS-11	11.1	1.5	6.4	
SS-12A	12.0	1.5	6.4	
SS-12	12.7	1.5	6.4	
SS-14	14.2	1.5	6.4	
SS-14.5	14.55	1.5	6.4	
SS-15	15.0	1.5	6.4	
SS-16	15.9	1.5	6.4	
SS-17.2	17.2	1.5	6.4	
SS-19	19.1	1.5	6.4	
SS-22	22.2	1.5	6.4	
SS-25	25.4	1.5	6.4	

P.C.B Ø4.8
THICKNESS 1.0~1.2

P.C.B Ø4.8
THICKNESS 1.2~1.7

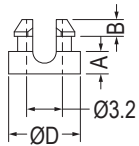

FOR M3 SCREW
【SS-2S】

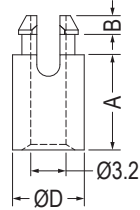

FOR M3 SCREW
【SS-10A】

Part No.	A	B	D	Package
★SS-2S	2.0	1.5	6.4	1000
SS-2.4	2.4	1.5	6.4	
SS-3	3.2	1.5	6.4	
SS-3.5	3.5	1.5	6.4	
SS-4	4.0	1.5	6.4	
SS-4.5	4.5	1.5	6.4	
SS-5	4.8	1.5	6.4	
SS-5A	5.0	1.5	6.4	
SS-6	6.4	1.5	6.4	

P.C.B Ø4.8
THICKNESS 1.6

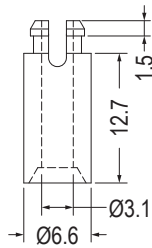

FOR M3 SCREW

Part No.	Package
SSA-12.7	1000

P.C.B Ø5.8
THICKNESS 1.6

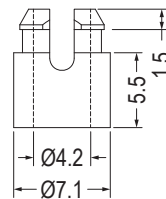

FOR M3.5 or M4 SCREW

Part No.	Package
SSA4-5.5	1000

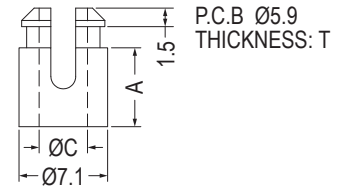

FOR M4 SCREW

Part No.	A	C	T	Package
SSU4-6.3	6.35	3.9	1.2~1.7	1000
SSU4-6.3L	6.35	4.3	1.6	
SSU4-9.5	9.5	3.9	1.2~1.7	
SSU4-9.5L	9.53	4.3	1.6	
SSU4-12.7	12.7	3.9	1.2~1.7	
★SSU4-12.7L	12.7	4.3	1.6	
SSU4-15.9	15.9	3.9	1.2~1.7	

P.C.B Ø5.9
THICKNESS 1.8

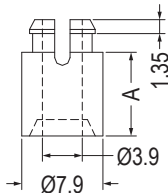

FOR M3.5 SCREW

Part No.	A	Package
SS3.5-6.3	6.3	1000
SS3.5-9.5	9.5	
SS3.5-12.7	12.7	
SS3.5-15	15.9	

P.C.B Ø5.9
THICKNESS 1.2~1.7

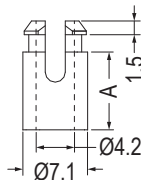

FOR M3.5 or M4 SCREW

Part No.	A	Package
SS4-3	3.0	1000
SS4-4	4.0	
SS4-4.6	4.6	
SS4-5	5.0	
SS4-6	6.4	
SS4-8	7.9	
SS4-9	9.5	
SS4-11	11.1	

P.C.B Ø5.9
THICKNESS 1.8

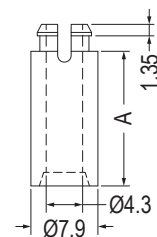

FOR M4 SCREW

【SS4-16L】

Part No.	A	Package
SS4-12S	12.0	1000
SS4-12	12.7	
SS4-16	15.9	
SS4-16L	15.9	
SS4-17	17.0	
SS4-19	19.1	
SS4-22	22.2	500
SS4-25	25.4	
SS4-30	30.0	

P.C.B Ø6.0
THICKNESS 1.6

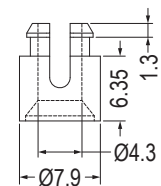

FOR M4 SCREW

Part No.	Package
SSUA4-6.3L	1000

PC板間隔柱 SPACER SUPPORT

用途：直接壓入板內固定。

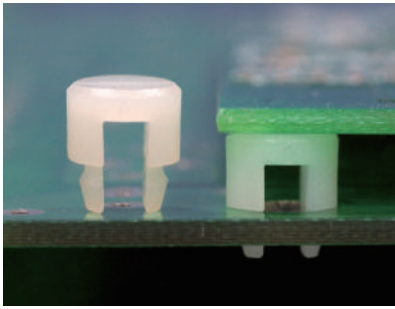

- Material: Nylon 66 (UL)
- Flame Class: 94V-2/94V-0
- Color: Natural/Black
- Unit: mm

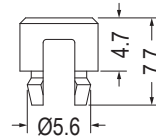

CHASSIS Ø5.0
THICKNESS 0.8

Part No.	Package
CUS-5	2000

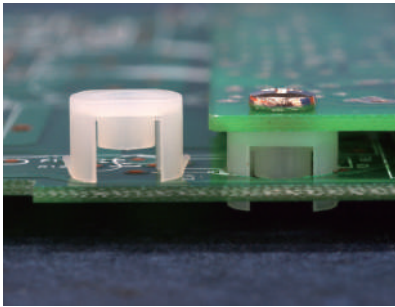

- Material: Nylon 66 (UL)
- Flame Class: 94V-2/94V-0
- Color: Natural/Black
- Unit: mm

用途：一頭直接壓入機板固定，另一頭用螺絲貫穿固定於機板，一般用於DVD內部之PC板固定。

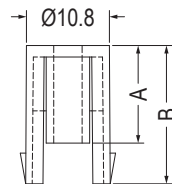
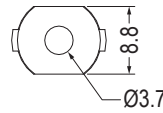

依照使用者的螺絲大小挖孔

(Hole must be based on the size of your screw)



MOUNTING HOLE

Part No.	A	B	Package
DVDS-5	5.0	7.8	500
DVDS-9	9.4	14.7	
DVDS-12	12.7	18.1	

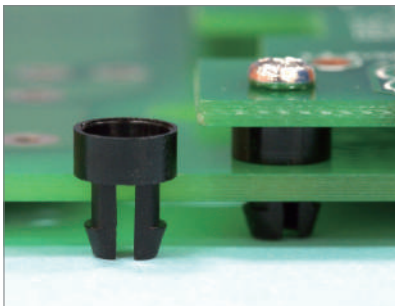

- Material: Nylon 66 (UL)
- Flame Class: 94V-2/94V-0
- Color: Natural/Black
- Unit: mm

用途：用於機器之面板固定，配合螺絲使用。

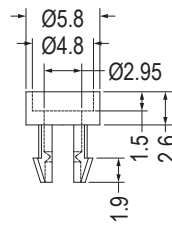

CHASSIS Ø4.0
THICKNESS 2.3~2.5

Part No.	Package
SOR-2	2000

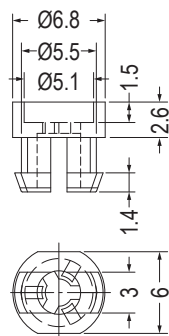
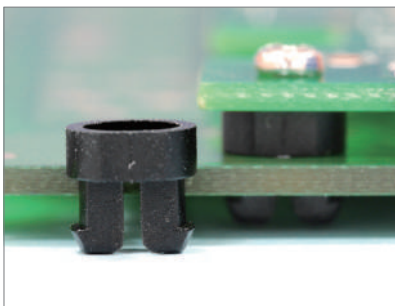

CHASSIS Ø5.5
THICKNESS 2.3~2.5

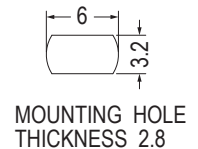
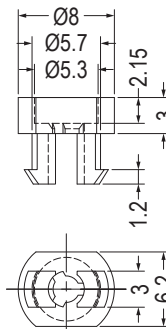

MOUNTING HOLE
THICKNESS 2.8

FOR M2.5 or M2.6 SCREW

Part No.	Package
SOR-1	2000

Part No.	Package
SOR-3	2000

PC板間隔柱 SPACER SUPPORT

用途：固定PC板於機板上，免工具，易拆卸。



- Material: Nylon 66 (UL)
- Flame Class: 94V-2/94V-0
- Color: Natural/Black
- Unit: mm

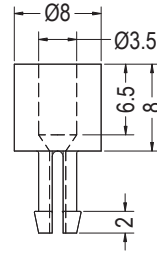

CHASSIS Ø3.5
THICKNESS 5.5

Part No.	Package
SSUL-8	1000

1

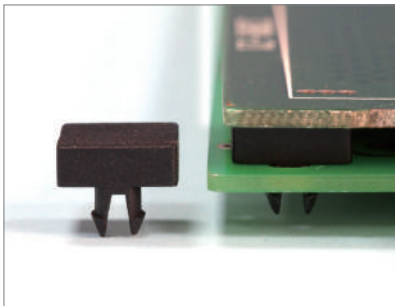

- Material: Nylon 66 (UL)
- Flame Class: 94V-2/94V-0
- Color: Natural/Black
- Unit: mm

用途：用於PC板墊高及支撐。

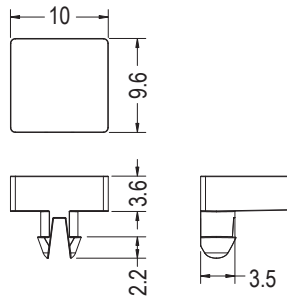

P.C.B Ø3.8
THICKNESS 2.5

Part No.	Package
LIES-1	1000

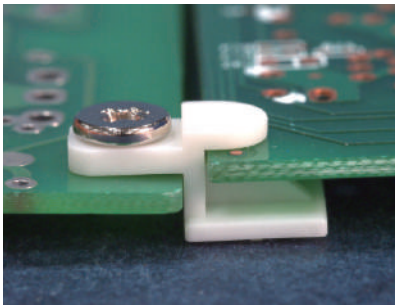

- Material: Nylon 66 (UL)
- Flame Class: 94V-2/94V-0
- Color: Natural/Black
- Unit: mm

用途：用於主機板或PC板固定。

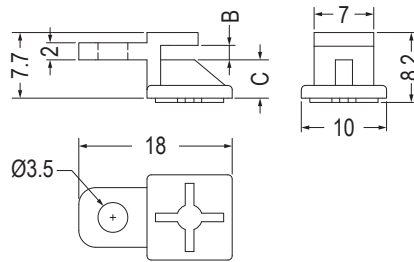

Part No.	B	C	Package
UBD-1	1.7	4.5	1000
UBD-2	2.0	4.15	

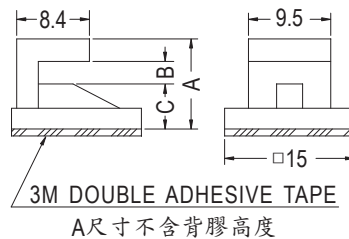
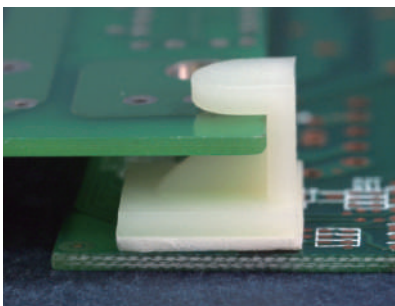

Part No.	A	B	C	Package
UB-6A	10.4	2.6	5.1	1000
UB-8A	11.9	2.4	7.0	
UB-10A	14.1	2.5	9.1	
UB-11A	15.0	2.5	10.0	
UB-12A	16.1	2.5	11.1	

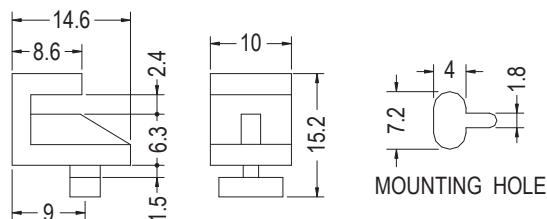

Part No.	Package
UB-6E	1000

PC板間隔柱 SPACER SUPPORT

用途：用於主機板或PC板固定。

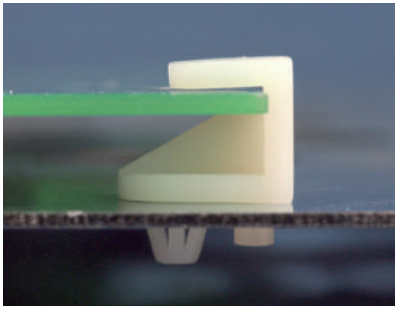

- Material: Nylon 66 (UL)
- Flame Class: 94V-2/94V-0
- Color: Natural/Black
- Unit: mm

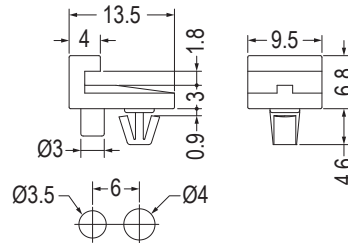

MOUNTING HOLE THICKNESS 0.8

Part No.	Package
UB-3S	1000

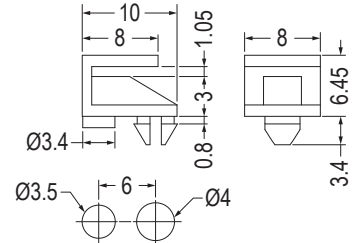

MOUNTING HOLE THICKNESS 0.8

Part No.	Package
UB-4	1000

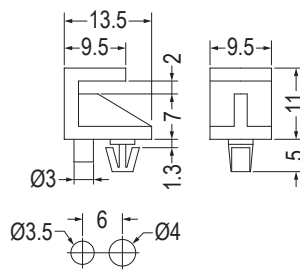

MOUNTING HOLE THICKNESS 1.0

Part No.	Package
UB-6	1000

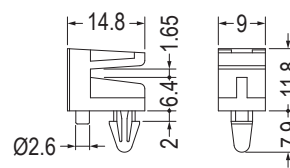

MOUNTING HOLE THICKNESS 1.6

Part No.	Package
UB-6D	1000

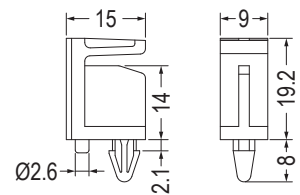

MOUNTING HOLE THICKNESS 1.6

Part No.	Package
UB-14D	1000

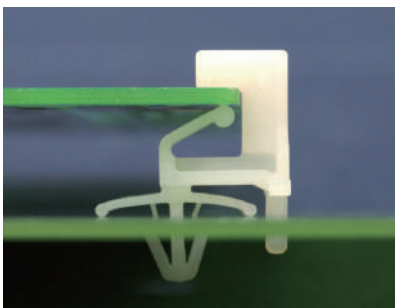

- Material: Nylon 66 (UL)
- Flame Class: 94V-2/94V-0
- Color: Natural/Black
- Unit: mm

用途：支撐PC板，使中間不致震動，載重而凹陷短路。

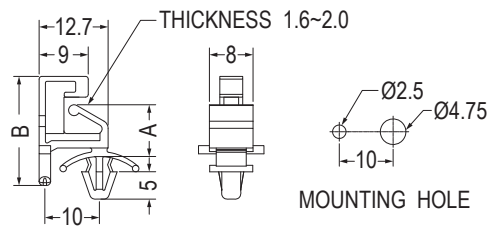

CHASSIS Ø4.8 THICKNESS 0.8~2.0

Part No.	A	B	Package
WLCF-6	6.3	16.8	1000
WLCF-8	8.0	18.5	
WLCF-9	9.5	20.0	
WLCF-12	12.7	23.2	
WLCF-16	15.9	26.4	

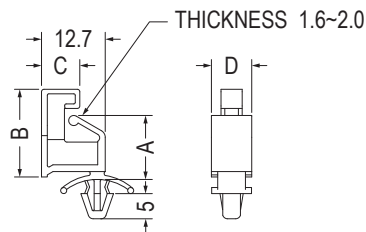
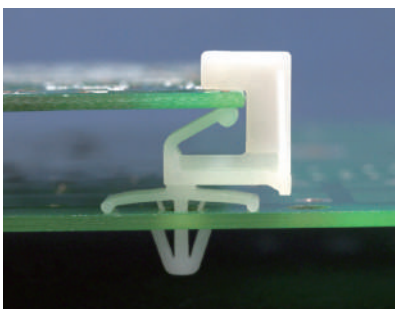

CHASSIS Ø4.8 THICKNESS 0.8~2.0

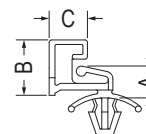

【 ULCF-6~ULCF-8S 】

Part No.	A	B	C	D	Package
ULCF-6	6.3	11.0	9.0	8.0	1000
ULCF-8	8.0	12.7	9.0	8.0	
ULCF-8S	8.0	12.7	7.6	6.0	
ULCF-9	9.5	14.2	9.0	8.0	
ULCF-12	12.7	17.4	9.0	8.0	
ULCF-16	15.9	20.6	9.0	8.0	

PC板間隔柱 SPACER SUPPORT

1

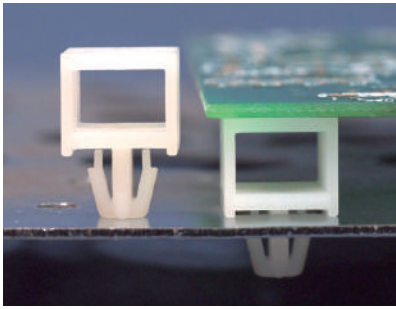

- Material: Nylon 66 (UL)
- Flame Class: 94V-2/94V-0
- Color: Natural/Black
- Unit: mm

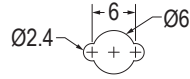
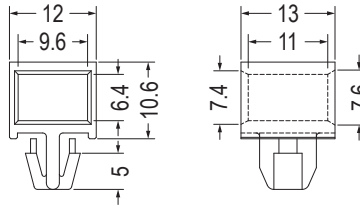

MOUNTING HOLE THICKNESS: T

Part No.	T	Package
LDD-10	1.6~1.8	500
LDD-10(2)	1.8~2.0	

用途：固定PC板於機板上，維修方便不佔空間。

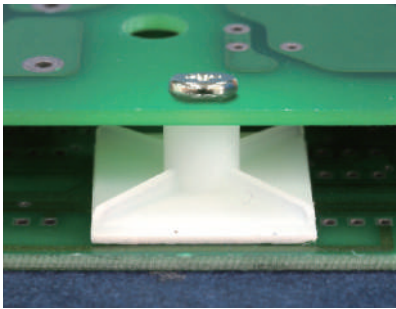

- Material: Nylon 66 (UL)
- Flame Class: 94V-2/94V-0
- Color: Natural/Black
- Unit: mm

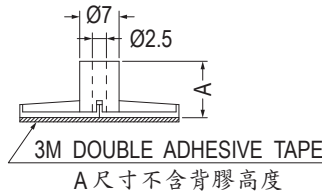
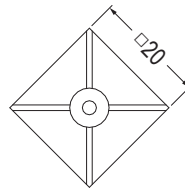

用途：背膠式，用於不能鑽孔之機板與PC板間之固定，配合螺絲使用，拆卸方便。

Part No.	A	Package
ASR-5	4.2	500
ASR-6	5.6	
ASR-7	6.2	
ASR-8	7.2	
ASR-9	8.2	
ASR-11	10.0	
ASR-12.7	11.9	
ASR-14.5	13.6	
ASR-15.9	15.1	
ASR-17.5	16.3	
ASR-19.1	18.3	

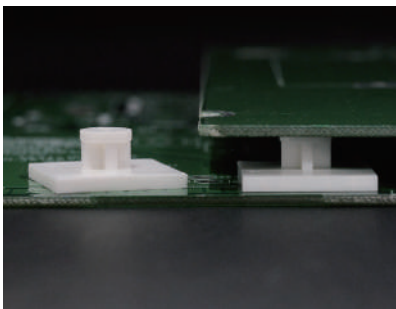

- Material: Nylon 66 (UL)
- Flame Class: 94V-2/94V-0
- Color: Natural/Black
- Unit: mm

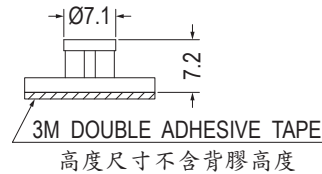
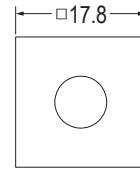

用途：背膠式，用於不能鑽孔之機板與PC板間之固定。

Part No.	Package
AST-7.2	500

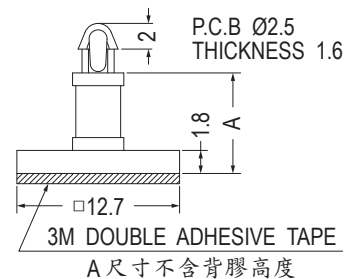
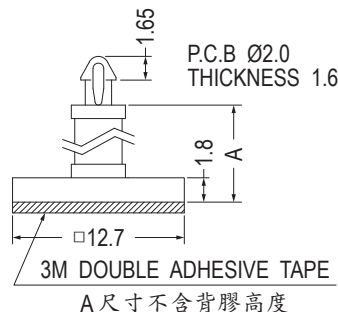
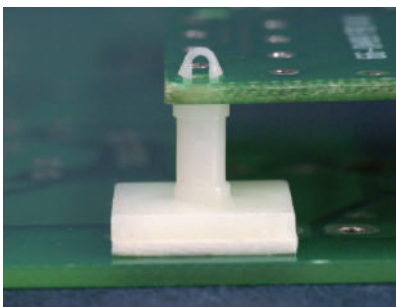

Part No.	A	Package
ISS-4.8	4.0	1000
ISS-6.4	5.6	
ISS-8	7.2	
ISS-9.5	8.7	
ISS-11.1	10.3	
ISS-12.7	11.9	
ISS-15.9	15.1	
ISS-19.1	18.3	

Part No.	A	Package
GSS-4.8	4.0	1000
GSS-6.4	5.6	
GSS-8	7.2	
GSS-9.5	8.7	
GSS-11.1	10.3	
GSS-12.7	11.9	
GSS-14.3	13.5	
GSS-15.9	15.1	
GSS-19.1	18.3	

PC板間隔柱 SPACER SUPPORT

用途：背膠式，用於不能鑽孔之機板與PC板間之固定。

- Material: Nylon 66 (UL)
- Flame Class: 94V-2/94V-0
- Color: Natural/Black
- Unit: mm

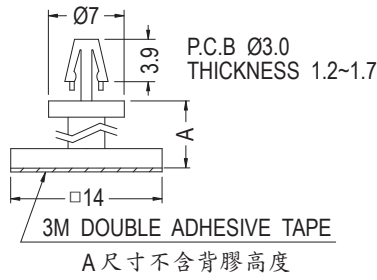
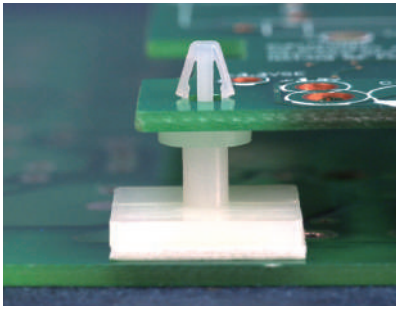

• Patented (專利品)

Part No.	A	Package
BSS-6	5.6	1000
BSS-9	8.0	
BSS-12	11.9	

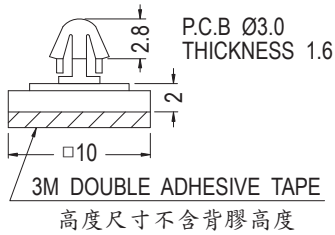

Part No.	Package
CSSA-2	1000

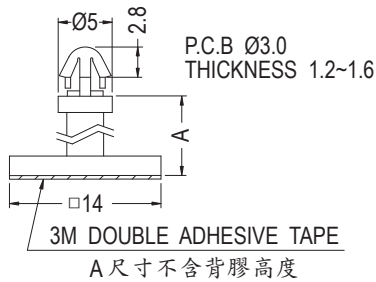

Part No.	A	Package
CSS-3.5	2.7	1000
CSS-5	4.0	
CSS-6.4	5.6	
CSS-8	7.2	
CSS-10	9.2	
CSS-11	9.7	
CSS-12.7	11.9	

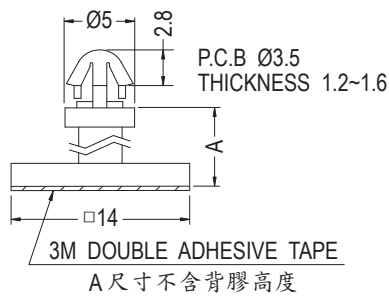
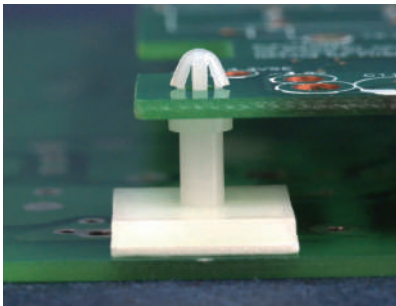

Part No.	A	Package
FSS-3.5	2.7	1000
FSS-5	4.0	
FSS-6.4	5.6	
FSS-8	7.2	
FSS-10	9.2	
FSS-12.7	11.9	

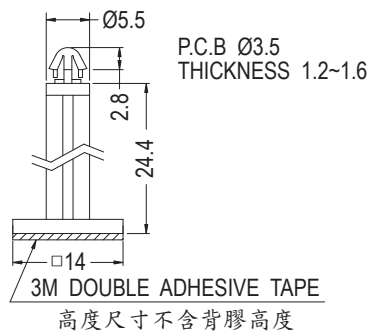
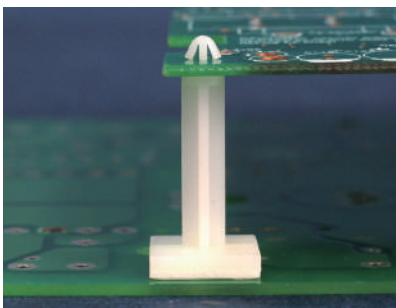

Part No.	Package
FSL-25	1000

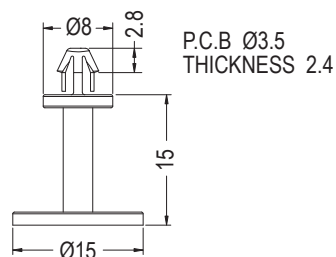
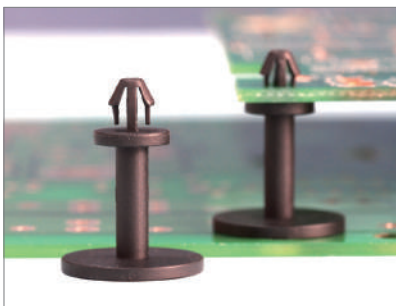

Part No.	Package
FSSA-15	1000

PC板間隔柱 SPACER SUPPORT

用途：背膠式，用於不能鑽孔之機板與PC板間之固定。

1

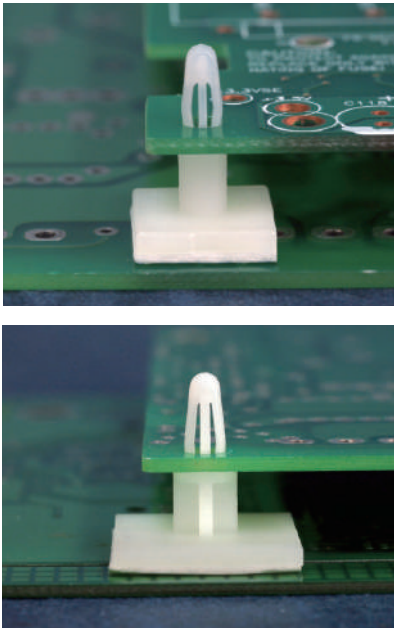

- Material: Nylon 66 (UL)
- Flame Class: 94V-2/94V-0
- Color: Natural/Black
- Unit: mm

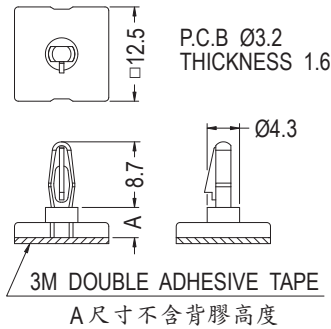

Part No.	A	Package
JSS-4.8	4.0	500
JSS-6.4	5.6	
JSS-7.9	6.8	
JSS-8.4	7.5	
JSS-9.5	8.5	
JSS-11	10.6	
JSS-12.7	11.7	
JSS-15.9	15.0	

• 背膠高度以0.9為標準

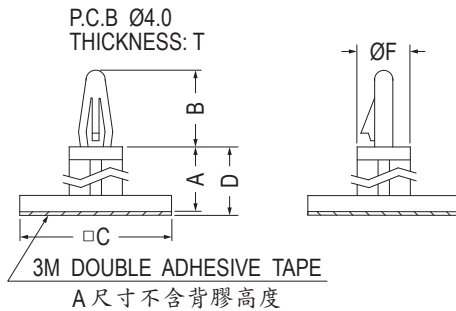

Part No.	A	B	C	D	F	T	Package
ASS-5	4.6	10.0	20.0	5.5	7.0	1.2~1.7	500
ASS-6	5.5	10.0	20.0	6.4	7.0	1.2~1.7	
ASS-6L	5.5	10.2	17.8	6.4	6.9	1.2~1.6	
ASS-8	7.2	10.0	20.0	8.1	7.0	1.2~1.7	
★ASS-9.5L	8.6	10.2	17.8	9.5	7.0	1.2~1.6	
ASS-10	9.0	10.0	20.0	9.9	7.0	1.2~1.7	
ASS-12.7L	11.8	10.2	18.0	12.7	6.9	1.2~1.6	
ASS-12	12.0	10.0	20.0	12.9	7.0	1.2~1.7	
ASS-15	15.4	10.0	20.0	16.3	7.0	1.2~1.7	
ASS-15.3S	15.3	8.0	17.8	16.2	7.1	1.2~1.6	
ASS-15.9L	15.0	10.2	18.0	15.9	6.9	1.2~1.6	
ASS-18.5	18.5	10.0	18.0	19.4	6.8	1.2~2.0	

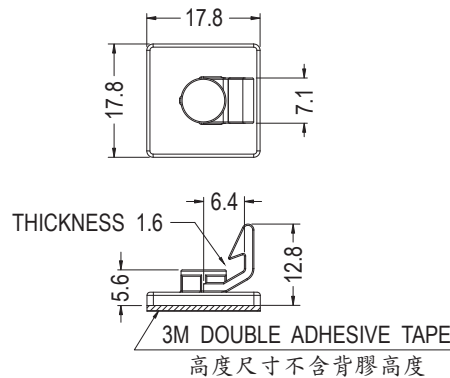
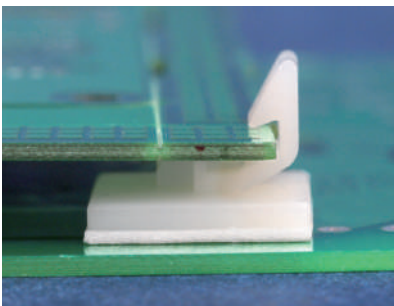

Part No.	Package
ULCK-6.4	1000



- Material: Nylon 66 (UL)
- Flame Class: 94V-2/94V-0
- Color: Natural/Black
- Unit: mm

用途：PC板直接壓入固定，另一頭用螺絲固定，省時易拆卸。

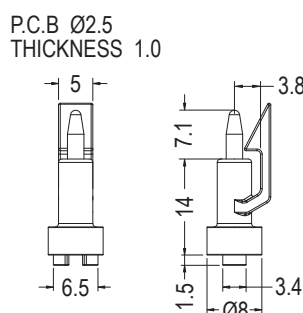

Part No.	Package
ULCI-11	1000

PC板間隔柱 SPACER SUPPORT

用途：PC板直接壓入固定，另一頭用螺絲固定，省時易拆卸。



- Material: Nylon 66 (UL)
- Flame Class: 94V-2/94V-0
- Color: Natural/Black
- Unit: mm

P.C.B Ø2.5
THICKNESS 1.0

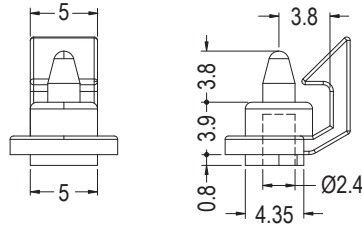

Part No.	Package
ULCIJ-4	1000



P.C.B Ø3.3
THICKNESS 1.0

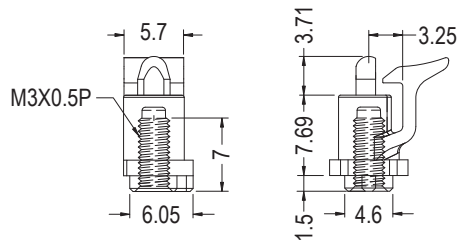

Part No.	Package
ULCD-7.8	1000

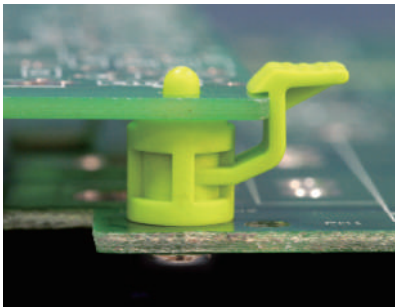

P.C.B Ø3.3
THICKNESS 1.6

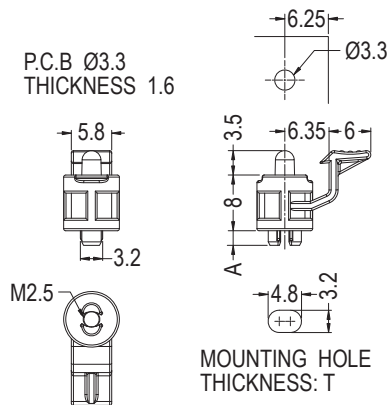

- Color: Natural/Black/Green

Part No.	A	T	Package
ULCH-2	2.1	2.16	1000
ULCH-2S	1.5	1.6	

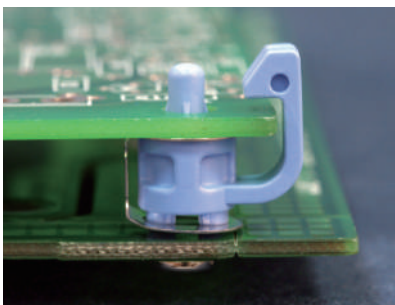

- Material: Nylon 66 (UL)
- Ground Terminal Material: SPTE
- Flame Class: 94V-2/94V-0
- Color: Natural/Black/Blue
- Unit: mm

用途：PC板與PC板之固定，加強導電幫助接地，不佔空間。

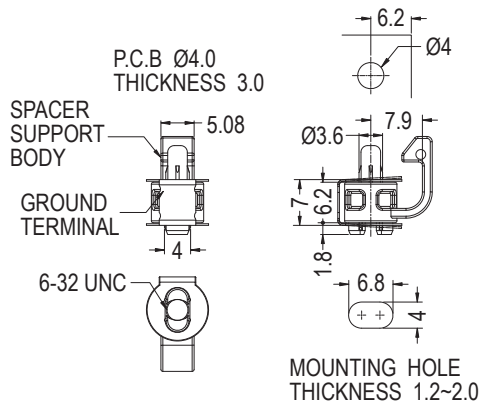

Part No.	Package
ULCH-1	1000

PC板間隔柱 SPACER SUPPORT

用途：PC板直接壓入固定，另一頭用螺絲固定，省時易拆卸。

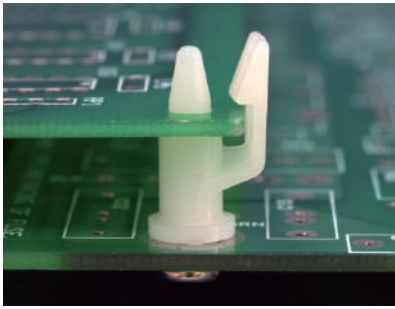

- Material: Nylon 66 (UL)
- Flame Class: 94V-2/94V-0
- Color: Natural/Black
- Unit: mm

P.C.B Ø4.0
THICKNESS 1.2~1.6

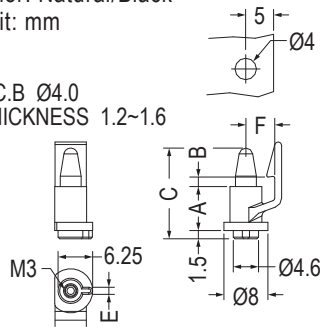

Part No.	A	B	C	E	F	Package
ULCC-6	6.3	1.73	14.8	1.3	5.25	500
ULCC-8	8.0	1.7	16.5	1.3	5.25	
ULCC-10	10.0	2.24	19.0	1.4	5.25	
ULCC-12	12.0	1.75	19.8	1.4	5.25	
ULCC-19	18.55	1.9	27.05	1.3	5.5	

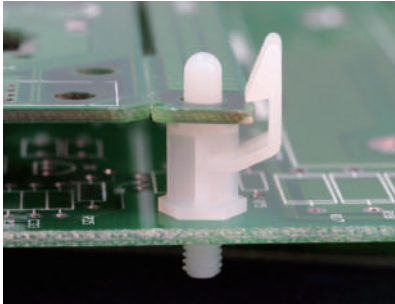

- Material: Nylon 66 (UL)
- Flame Class: 94V-2/94V-0
- Color: Natural/Black
- Unit: mm

MOUNTING HOLE
THICKNESS 1.6

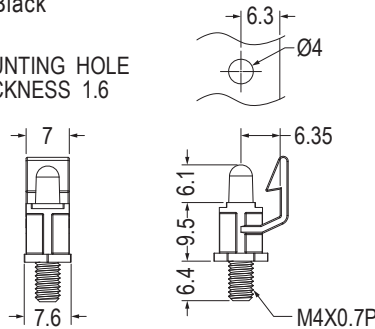

Part No.	Package
ULCBM4-9.5	1000



- Material: Nylon 66 (UL)
- Flame Class: 94V-2/94V-0
- Color: Natural/Black
- Unit: mm

P.C.B Ø3.3
THICKNESS 1.57

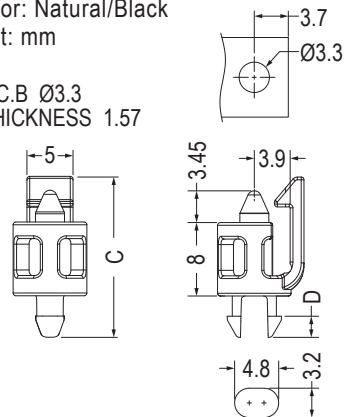

用途：PC板直接壓入固定，另一頭直接壓入機板固定，省時易拆裝。

Part No.	C	D	T	Package
ULCSA-8	17.45	2.3	2.13	1000
ULCSA-8S	16.5	1.9	1.57	

MOUNTING HOLE
THICKNESS: T



P.C.B Ø3.3
THICKNESS 1.57

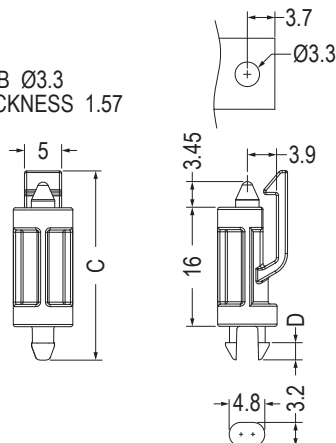

Part No.	C	D	T	Package
ULCSA-16	25.45	2.3	2.13	1000
ULCSA-16S	24.5	1.9	1.57	

MOUNTING HOLE
THICKNESS: T

PC板間隔柱 SPACER SUPPORT

用途：PC板直接壓入固定，另一頭直接壓入機板固定，省時易折裝。

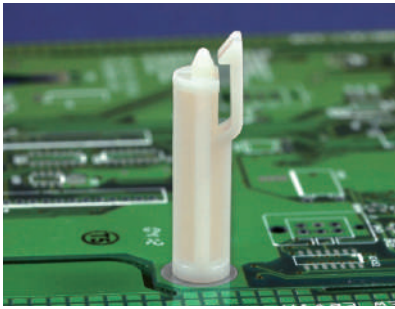

- Material: Nylon 66 (UL)
- Flame Class: 94V-2/94V-0
- Color: Natural/Black
- Unit: mm

P.C.B Ø3.3
THICKNESS 1.57

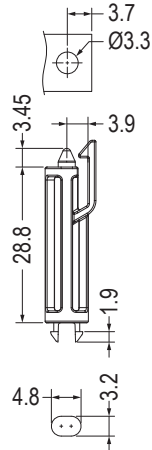

MOUNTING HOLE
THICKNESS 1.57

Part No.	Package
ULCSA-28.8S	500

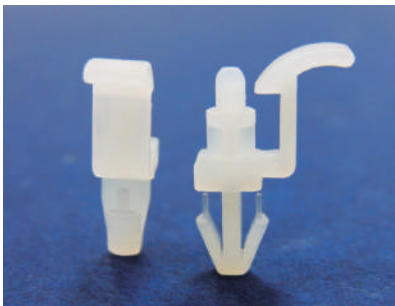

P.C.B Ø2.35
THICKNESS 1.0

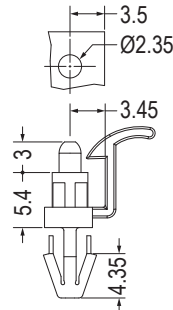
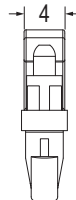

CHASSIS Ø4.0
THICKNESS 2.4

Part No.	Package
ULCBA-5	1000



HOLE IN P.C.B
THICKNESS 1.3

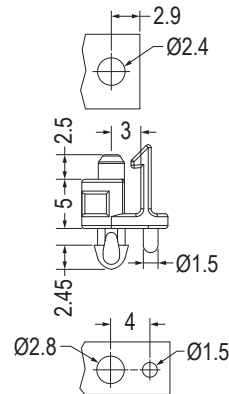

MOUNTING HOLE
THICKNESS 1.7

Part No.	Package
ULCSD-5	1000

HOLE IN P.C.B
THICKNESS: E

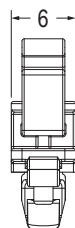

HOLE IN P.C.B
THICKNESS: T

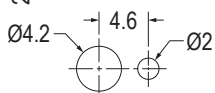
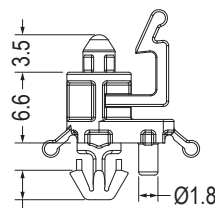
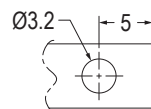

Part No.	E	T	Package
ULCSF-6.6	1.6	1.93	1000
ULCSF-6.6L	1.4~1.8	2.3~2.7	
ULCSF-6.6XL	1.4~1.8	2.52~3.08	
ULCSF-6.6XXL	1.4~1.8	2.83~3.47	

PC板間隔柱 SPACER SUPPORT

用途：PC板直接壓入固定，另一頭直接壓入機板固定，省時易拆裝。

1

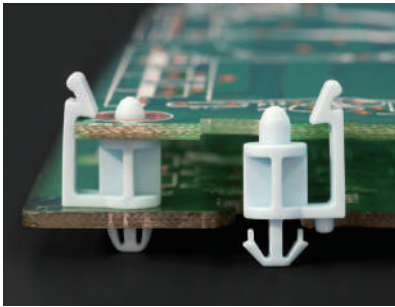

- Material: Nylon 66 (UL)
- Flame Class: 94V-2/94V-0
- Color: Natural/Black/Blue
- Unit: mm

HOLE IN P.C.B
THICKNESS 1.6

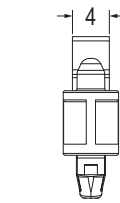

MOUNTING HOLE
THICKNESS 2.0

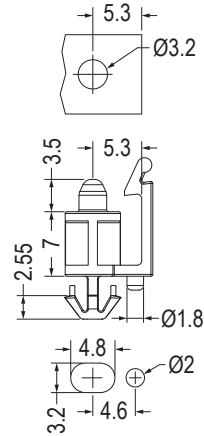

Part No.	Package
ULCSE-7	1000

HOLE IN P.C.B
THICKNESS 1.6

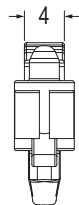

MOUNTING HOLE
THICKNESS: T

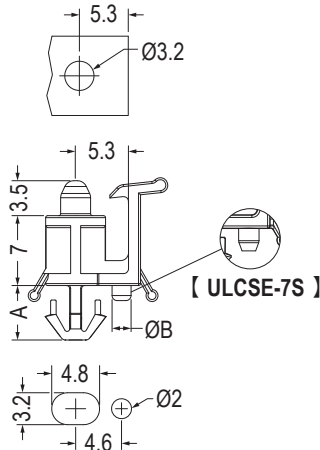

Part No.	A	B	T	Package
ULCSE-7S	4.35	1.8	1.6	1000
ULCSE-7L	5.0	1.9	2.34	
ULCSE-7L1	5.45	1.9	2.4	



P.C.B Ø2.6
THICKNESS 0.8~1.0

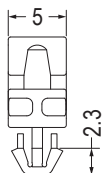

MOUNTING HOLE
THICKNESS 1.4~1.6

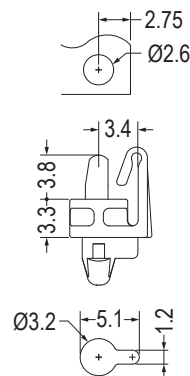

Part No.	Package
LCUE-3.3	2000

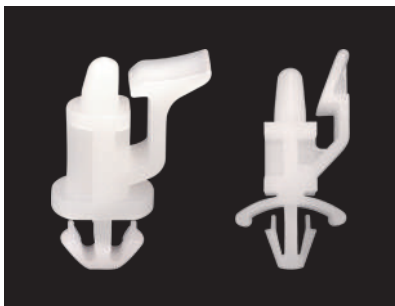

P.C.B Ø3.4
THICKNESS 1.2

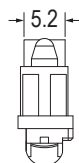

MOUNTING HOLE
THICKNESS 1.6

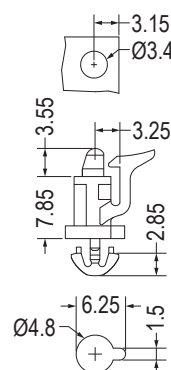

P.C.B Ø4.0
THICKNESS 0.8~1.6

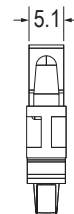

CHASSIS Ø4.0
THICKNESS 0.8~2.0

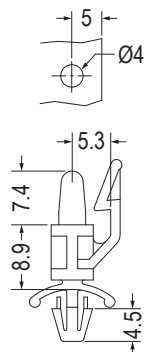

Part No.	Package
ULCBA-7.8	1000

Part No.	Package
ULCE-9	1000

PC板間隔柱 SPACER SUPPORT

用途：用於不能鑽孔之機板與PC板間之固定。

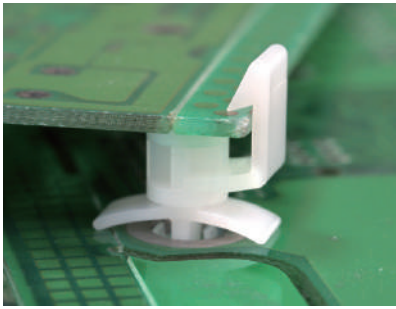

- Material: Nylon 66 (UL)
- Flame Class: 94V-2/94V-0
- Color: Natural/Black
- Unit: mm

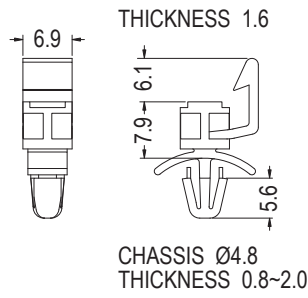

Part No.	Package
ULCCBB-7.9	1000

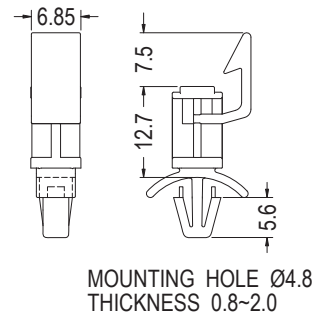

Part No.	Package
ULCCBB-12.7L	1000



- Material: Nylon 66 (UL)
- Flame Class: 94V-2/94V-0
- Color: Natural/Black/Blue
- Unit: mm

用途：支撐PC板，使中間不致震動，載重而凹陷短路。

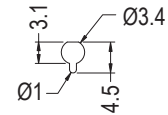
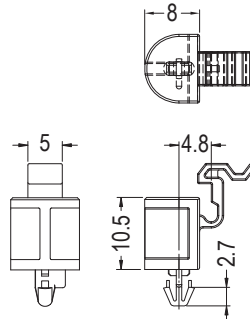

MOUNTING HOLE THICKNESS 2.4

Part No.	Package
LCUA-11	1000



- Material: Nylon 66 (UL)
- Flame Class: 94V-2/94V-0
- Color: Natural/Black/Green
- Unit: mm

用途：PC板直接壓入固定，另一頭直接壓入機板固定，省時易拆裝。

P.C.B Ø3.2 THICKNESS 1.6

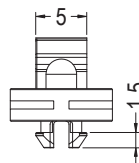

MOUNTING HOLE THICKNESS 1.0

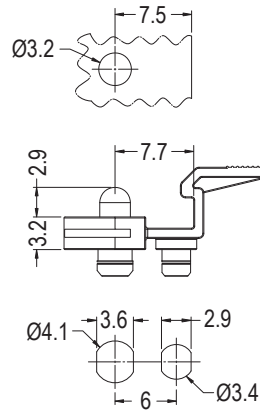

Part No.	Package
LCUAD-1	1000



- Material: Nylon 66 (UL)
- Flame Class: 94V-2/94V-0
- Color: Natural/Black
- Unit: mm

P.C.B Ø4.0 THICKNESS 1.6

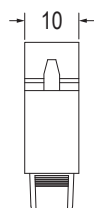

MOUNTING HOLE THICKNESS 0.8~2.4

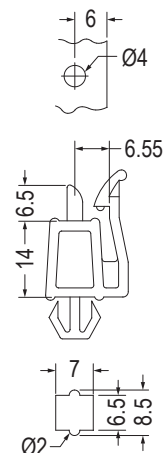

Part No.	Package
KES-15	500

PC板間隔柱 SPACER SUPPORT

用途：PC板直接壓入固定，另一頭直接壓入機板固定，省時易拆裝。

- Material: Nylon 66 (UL)
- Flame Class: 94V-2/94V-0
- Color: Natural/Black
- Unit: mm

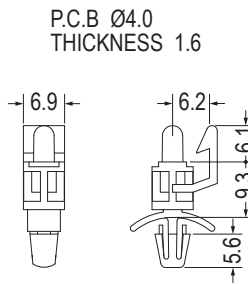
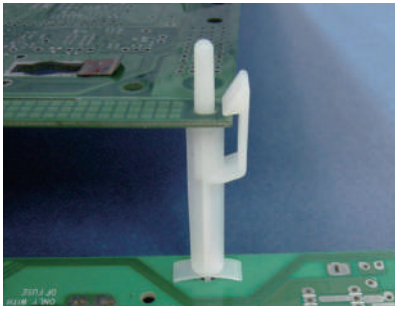

CHASSIS Ø4.8
THICKNESS 1.6-2.2

Part No.	Package
ULCB-9S	500

P.C.B Ø4.0
THICKNESS 1.6

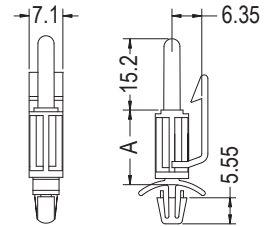

CHASSIS Ø4.8
THICKNESS 1.6

Part No.	A	Package
ULCB-15	15.9	500
ULCB-38	38.1	

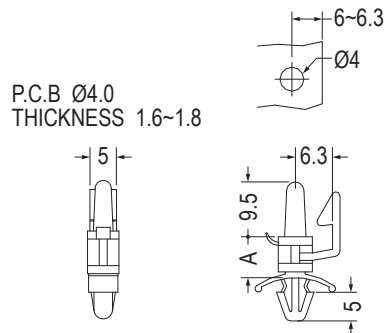
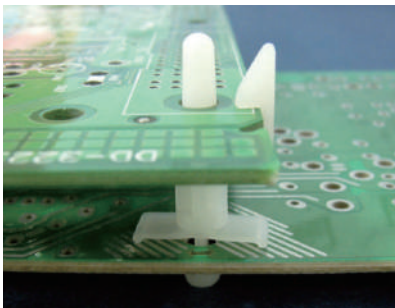

CHASSIS Ø4.8
THICKNESS 0.5-2.0

Part No.	A	Package
ULCB-6	6.3	1000
ULCB-8	8.0	
ULCB-9	9.5	
ULCB-10	10.0	
ULCB-12	12.7	
ULCB-16	15.9	
ULCB-19.1	19.1	
ULCB-23	23.0	

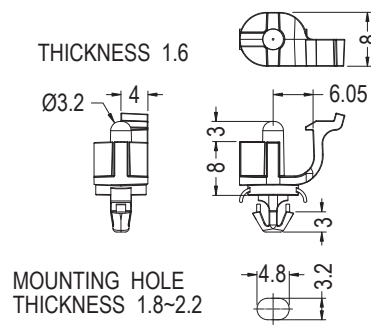
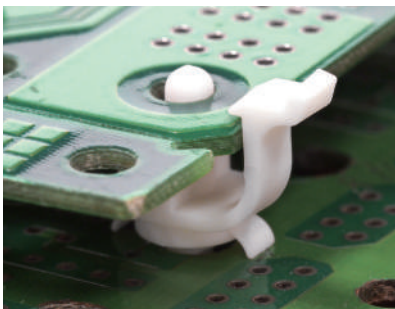

MOUNTING HOLE
THICKNESS 1.8-2.2

Part No.	Package
LCUAC-2L	1000

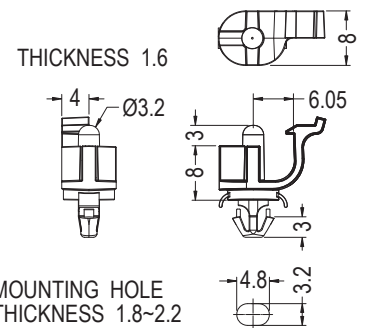

MOUNTING HOLE
THICKNESS 1.8-2.2

- Color: Natural/Black/Green/Gary

Part No.	Package
LCUAC-2R	1000

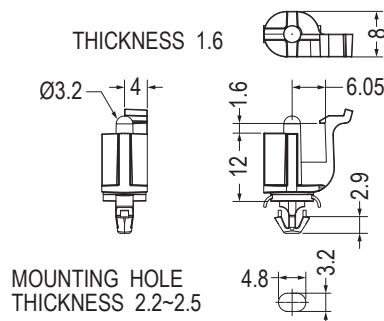
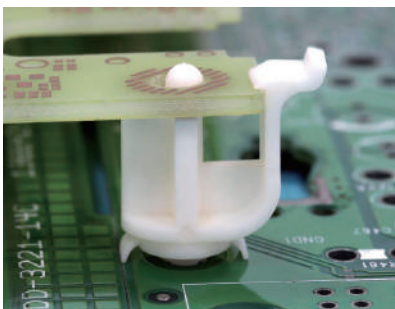

MOUNTING HOLE
THICKNESS 2.2-2.5

Part No.	Package
LCUAC-3L	1000

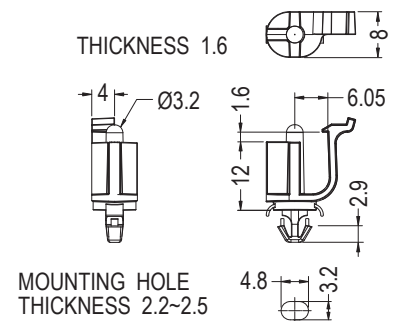

MOUNTING HOLE
THICKNESS 2.2-2.5

Part No.	Package
LCUAC-3R	1000

PC板間隔柱 SPACER SUPPORT

用途：PC板直接壓入固定，另一頭直接壓入機板固定，省時易拆裝。

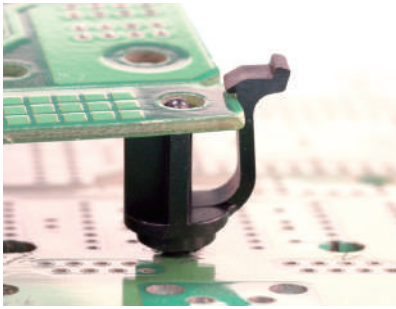

- Material: Nylon 66 (UL)
- Flame Class: 94V-2/94V-0
- Color: Natural/Black
- Unit: mm

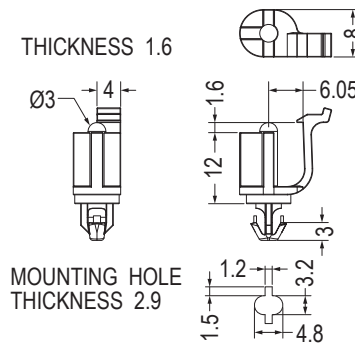

Part No.	Package
LCUAC-7L	1000

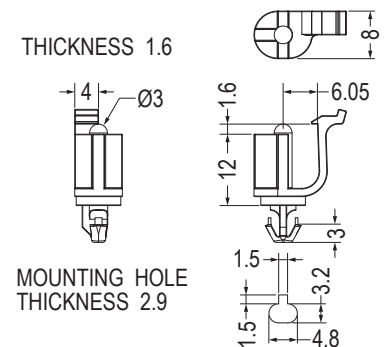

Part No.	Package
LCUAC-7R	1000

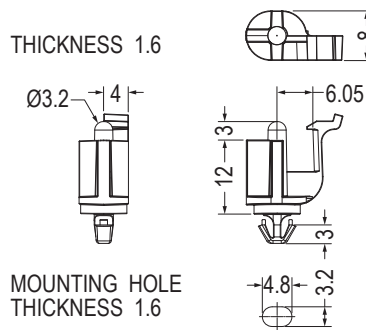
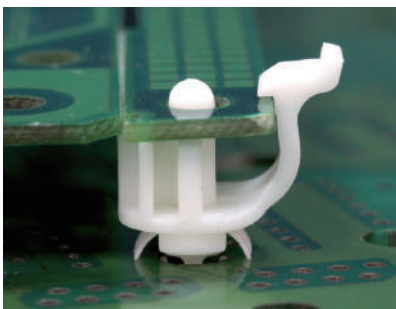

Part No.	Package
LCUAC-8L	1000

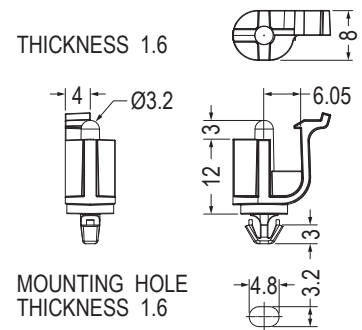

Part No.	Package
LCUAC-8R	1000

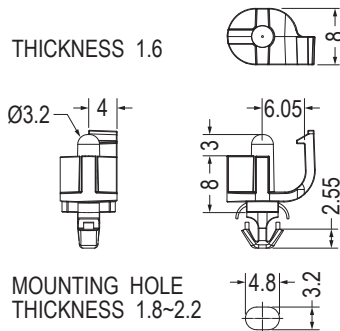

Part No.	Package
LCUAC-9L	1000

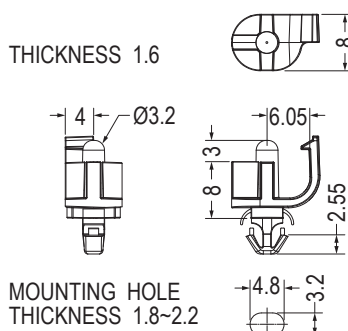

Part No.	Package
LCUAC-9R	1000

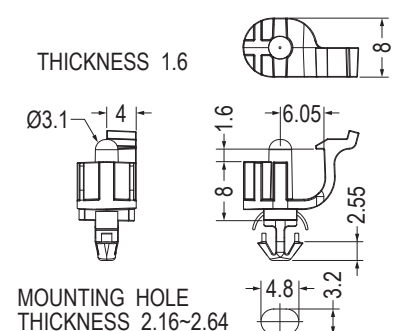

Part No.	Package
LCUAC-11L	1000

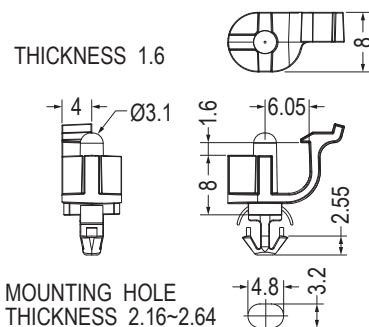

Part No.	Package
LCUAC-11R	1000

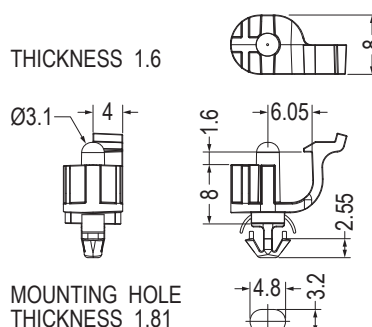

Part No.	Package
LCUAE-8L	1000

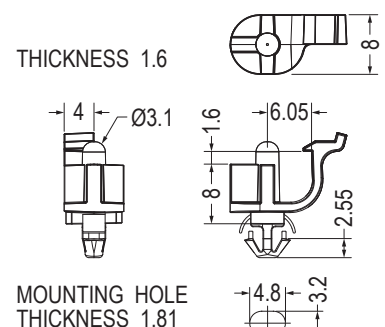

Part No.	Package
LCUAE-8R	1000

PC板間隔柱 SPACER SUPPORT

用途：PC板直接壓入固定，另一頭直接壓入機板固定，省時易拆裝。

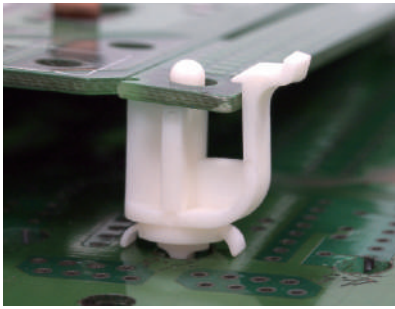

- Material: Nylon 66 (UL)
- Flame Class: 94V-2/94V-0
- Color: Natural/Black
- Unit: mm

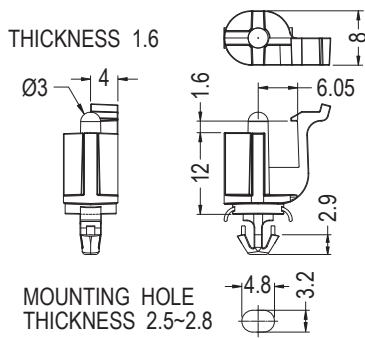

Part No.	Package
LCUAE-12L	1000

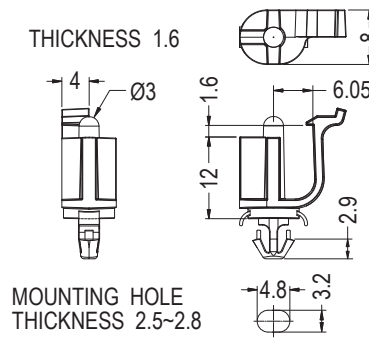

Part No.	Package
LCUAE-12R	1000

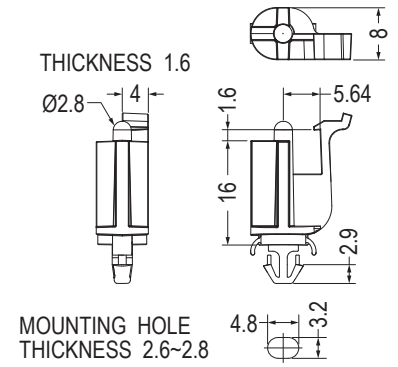

Part No.	Package
LCUAE-16LA	1000

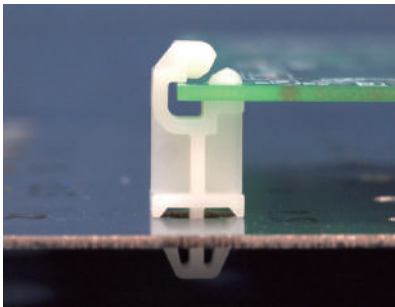

- Material: Nylon 66 (UL)
- Flame Class: 94V-2/94V-0
- Color: Natural/Black
- Unit: mm

用途：用於PC板固定及墊高，拆卸方便。

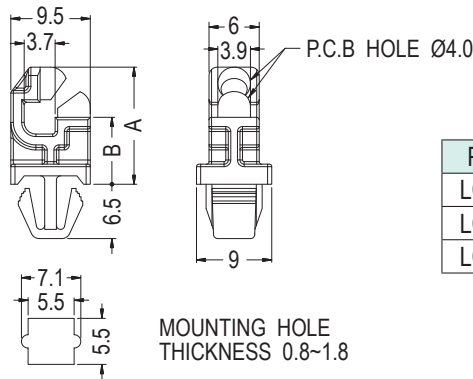

Part No.	A	B	Package
LCMM-8	14.0	8.0	1000
LCMM-12	18.0	12.0	
LCMM-18	24.0	18.0	

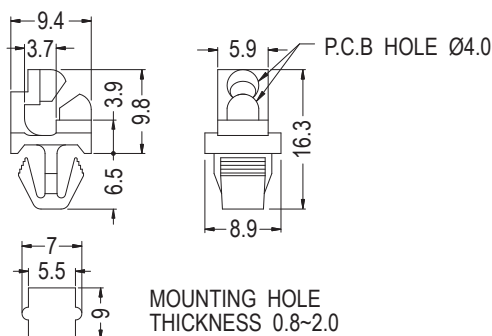
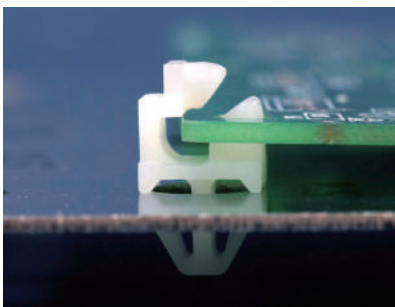

Part No.	Package
LCMM-4	1000

PC板間隔柱 SPACER SUPPORT

用途：將PC板固定於機殼上，PC板可前後30°移動。



- Material: Nylon 66 (UL)
- Flame Class: 94V-2/94V-0
- Color: Natural/Black
- Unit: mm

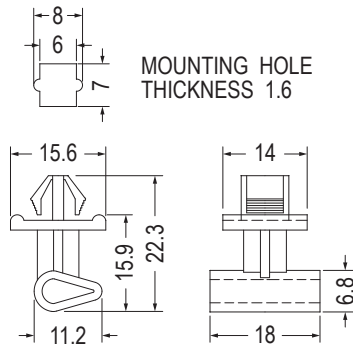

Part No.	Package
PS-16	500

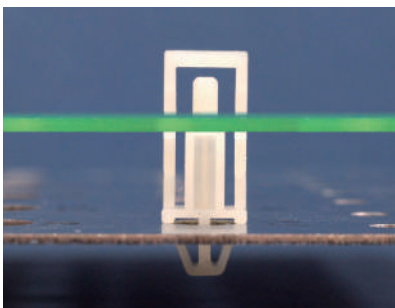

- Material: Nylon 66 (UL)
- Flame Class: 94V-2/94V-0
- Color: Natural/Black
- Unit: mm

用途：用於PC板固定及墊高，拆卸方便。

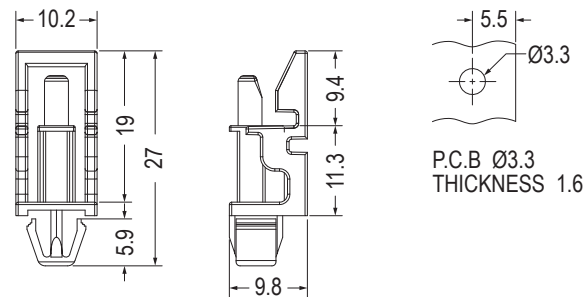

Part No.	Package
KEMS-11.3	500

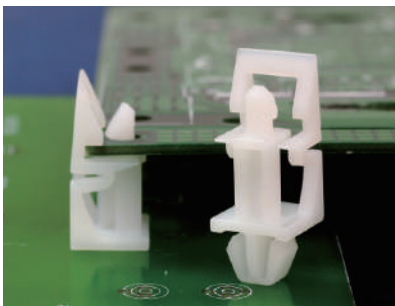

CHASSIS HOLE THICKNESS 0.8~1.2

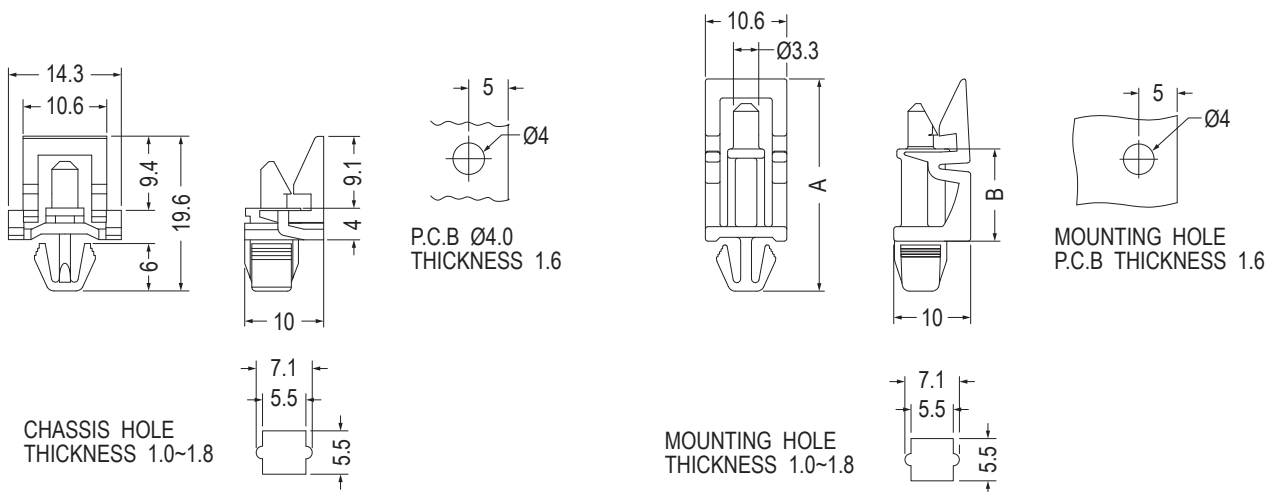
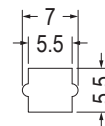

Part No.	Package
KEML-4	500

Part No.	A	B	Package
KEML-10	25.6	10.0	500
KEML-12	27.6	12.0	1000

PC板間隔柱 SPACER SUPPORT

用途：用於PC板與機板之固定。

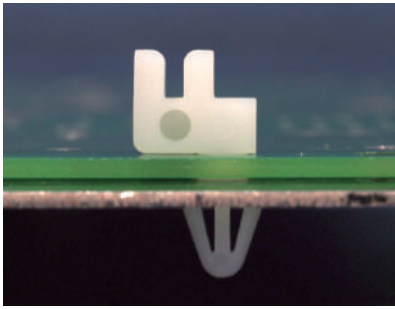

- Material: Nylon 66 (UL)
- Flame Class: 94V-2/94V-0
- Color: Natural/Black
- Unit: mm

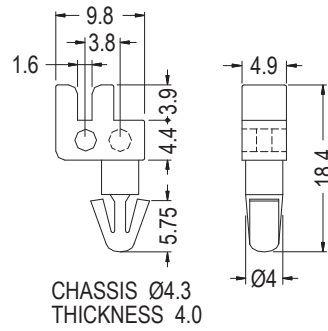

Part No.	Package
LCU-18	2000



- Material: Nylon 66 (UL)
- Flame Class: 94V-2/94V-0
- Color: Natural/Black
- Unit: mm

用途：背膠式，用於PC板端直接壓入固定。

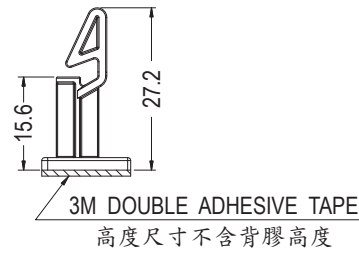
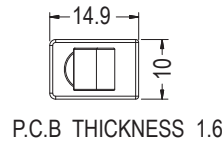

Part No.	Package
ULCKA-15.6	1000

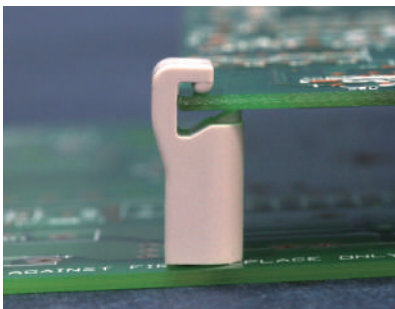

- Material: PC+ABS
- Color: Natural/Gray
- Unit: mm

用途：用於PCB固定及墊高，拆裝方便。

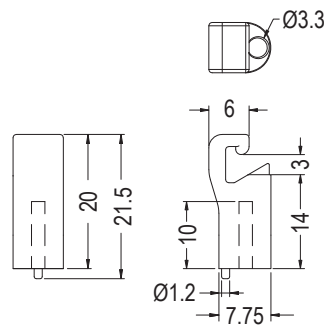

Part No.	Package
KESS-19	500

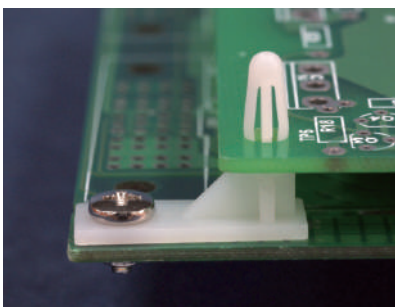

- Material: Nylon 66 (UL)
- Flame Class: 94V-2/94V-0
- Color: Natural/Black
- Unit: mm

用途：機板部分用螺絲固定，另一頭直接壓入PC板。

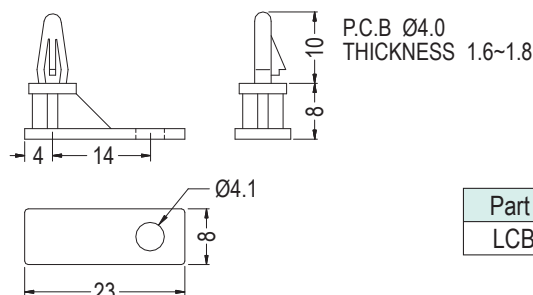

Part No.	Package
LCBL-8	1000

PC板間隔柱 SPACER SUPPORT

用途：用於PC板與機板之固定。

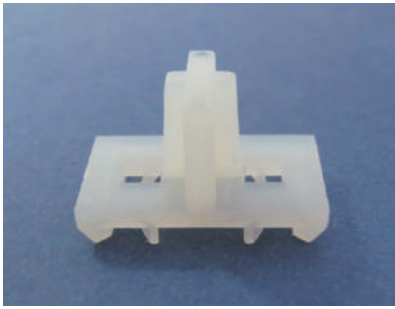

- Material: Nylon 66 (UL)
- Flame Class: 94V-2/94V-0
- Color: Natural/Black
- Unit: mm

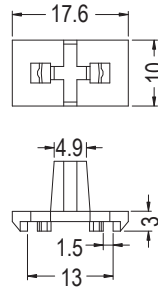

Part No.	Package
LIH-8	2000

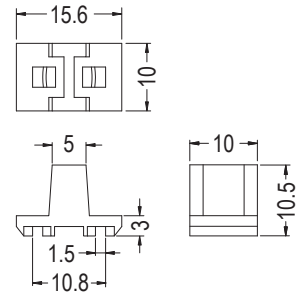

Part No.	Package
MOU-01	2000

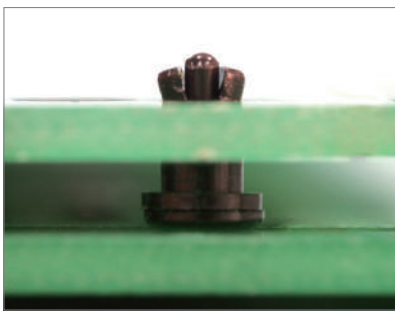

- Material: Nylon 66 (UL)
- Flame Class: 94V-2/94V-0
- Color: Natural/Black
- Unit: mm

用途：用於PC板與機板間墊高，省時方便。

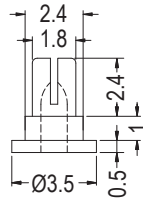

【 SRMA-2A 】

CHASSIS Ø1.8
THICKNESS 1.0~1.2

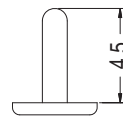

【 SRMA-2B 】

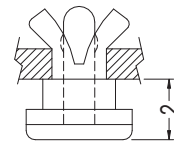

組裝示意圖

Part No.	組裝方式	Package
SRMA-2	不組裝	2000
SRMA-2F	SRMA-2A	
	SRMA-2B	
	組裝	

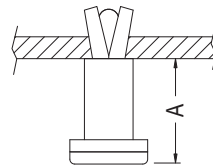
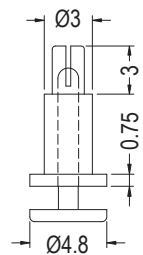
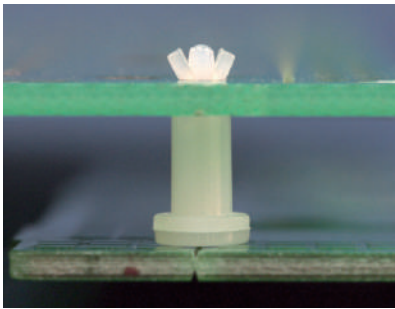

組裝示意圖

CHASSIS Ø2.0
THICKNESS 0.8~1.6

Part No.	A	Package
SRMA-3	3.0	2000
SRMA-3.5	3.5	
SRMA-4	4.0	
SRMA-5	5.0	
SRMA-6	6.5	
SRMA-9	9.0	

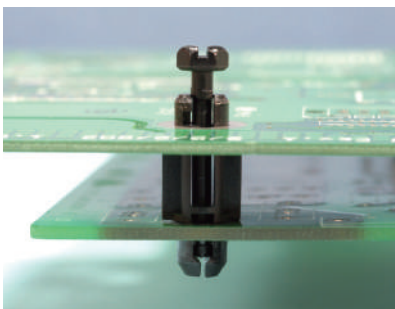

- Clip Material: PC (UL)/94V-2
- Pin Material: Nylon 66 (UL)/94V-2
- Color: Black
- Unit: mm

用途：用於PC板與機板間之固定易裝卸。

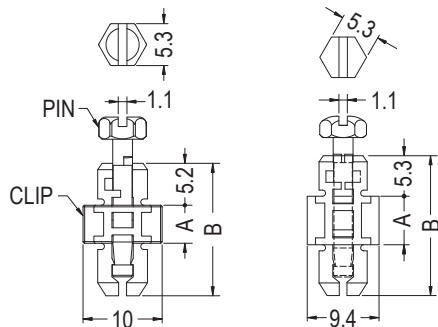

CHASSIS Ø6.3~Ø6.4
THICKNESS 1.4~2.4

【 SCMB-4.8 】

CHASSIS Ø6.4~Ø6.5
THICKNESS 0.8~1.6

Part No.	A	B	Package
SCMB-4.8	4.8	16.6	1000
SCMB-6.3	6.35	18.3	
SCMB-9.5	9.5	21.45	
SCMB-12.7	12.7	24.65	
SCMB-15.9	15.9	27.85	
SCMB-19.1	19.1	31.05	

間隔柱 SPACER

用途：用於零件之固定。



- Material: PC (UL)
- Flame Class: 94V-2
- Color: Natural/Black
- Unit: mm

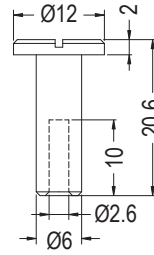

Part No.	Package
SMHC-1	1000

PC板間隔柱 SPACER SUPPORT

用途：PC板與PC板間之固定，不佔空間。

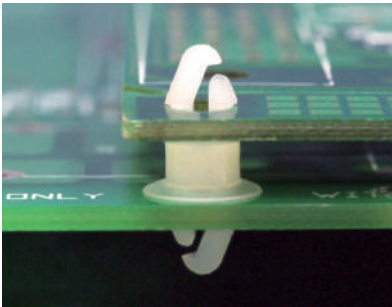

- Material: Nylon 66 (UL)/PC (UL)
- Flame Class: 94V-2/94V-0
- Color: Natural/Black
- Unit: mm

P.C.B Ø4.0
THICKNESS 1.6~1.9

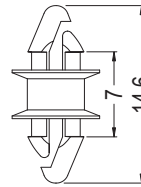

Part No.	Package
MSPR-3	1000

P.C.B Ø4.0
THICKNESS 1.6~1.9

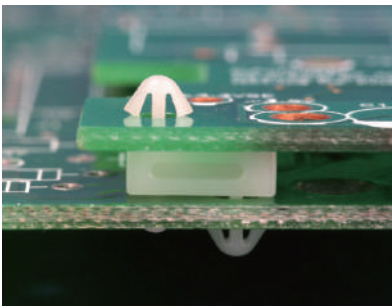

- Material: Nylon 66 (UL)
- Flame Class: 94V-2/94V-0
- Color: Natural/Black
- Unit: mm

用途：兩片PC板間隔之固定。

P.C.B Ø3.2
THICKNESS 1.6

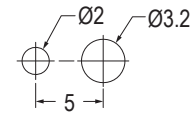
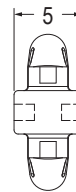
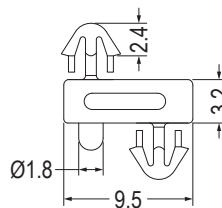

MOUNTING HOLE

P.C.B Ø3.2
THICKNESS 1.6

Part No.	Package
LUCE-1	1000

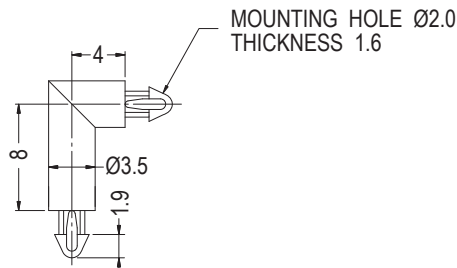
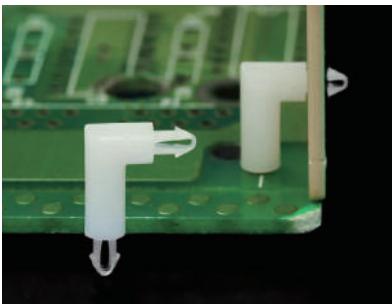

MOUNTING HOLE Ø2.0
THICKNESS 1.6

Part No.	Package
EM-682	2000

PC板固定座 PCB MOUNTING BLOCK

用途：用於PC板固定，使PC板與機板成90°固定。

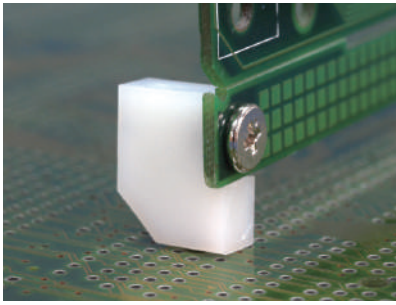

- Material: Nylon 66 (UL)
- Flame Class: 94V-2/94V-0
- Color: Natural/Black
- Unit: mm

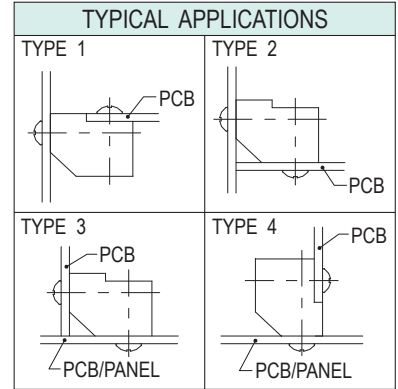
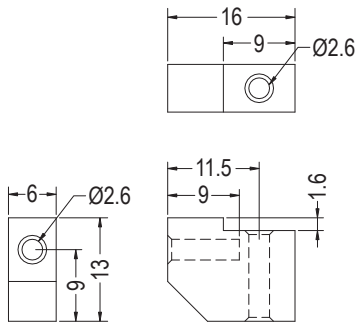

Part No.	Package
PMB-1	500

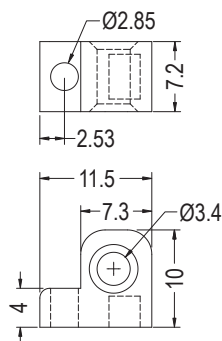
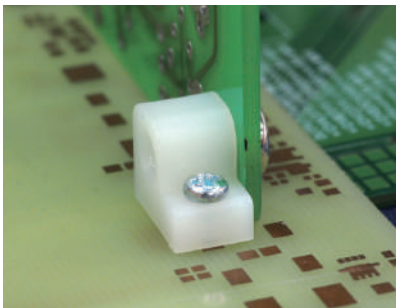

Part No.	Package
PMB-2	500

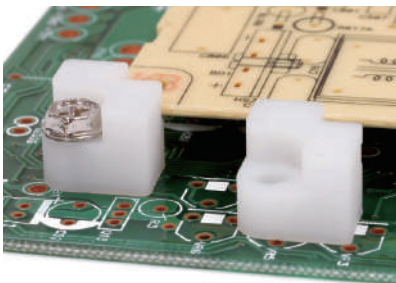

- Material: Nylon 66 (UL)
- Flame Class: 94V-2/94V-0
- Color: Natural/Black
- Unit: mm

用途：快速固定PC板於機板上。

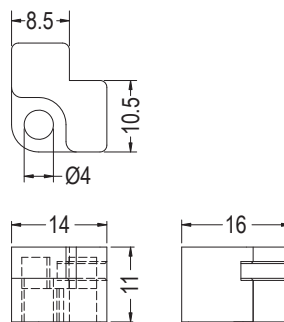

Part No.	Package
TCEA-1	1000



- Material: PC (UL)
- Flame Class: 94V-2/94V-0
- Color: Transparent
- Unit: mm

用途：配合螺絲，固定PC板於機板上。

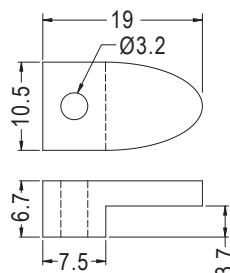

Part No.	Package
HW2839	1000

PC板固定扣 PCB HINGE

用途：一端固定於機板或PC板上，另一端固定於PC板上成90°。

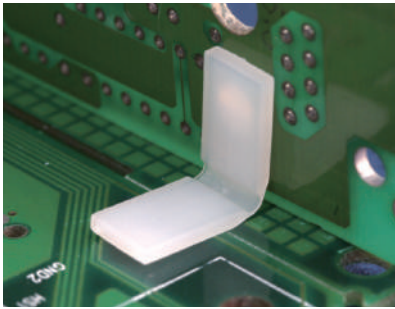

- Material: Nylon 66 (UL)
- Flame Class: 94V-2/94V-0
- Color: Natural/Black
- Unit: mm

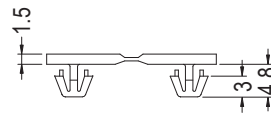

P.C.B Ø4.0
THICKNESS 1.6~1.8

Part No.	Package
LPZ-1	1000

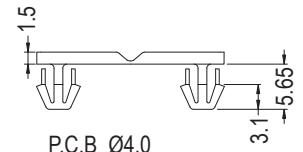

P.C.B Ø4.0
THICKNESS 2.36

Part No.	Package
LPZ-9	1000

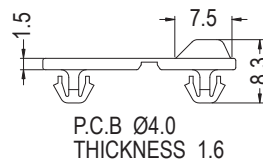
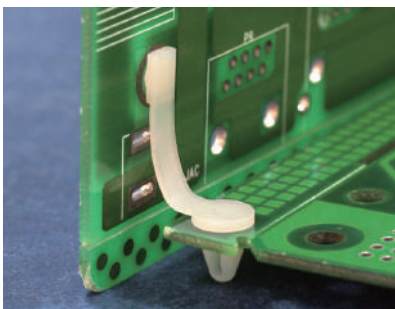

P.C.B Ø4.0
THICKNESS 1.6

Part No.	Package
LPZ-6	1000

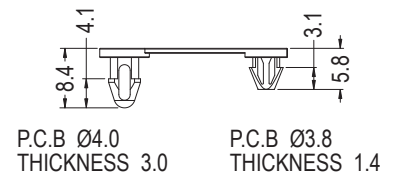

P.C.B Ø4.0 THICKNESS 3.0 P.C.B Ø3.8 THICKNESS 1.4

Part No.	Package
LPZ-2	1000

固定片 BRACKET

用途：快速固定PC板於機板上。

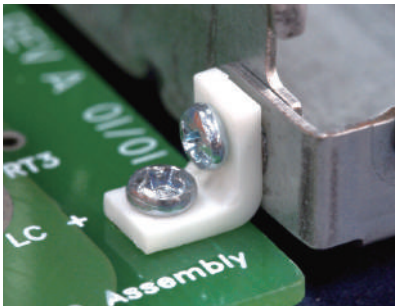

- Material: Nylon 66 (UL)
- Flame Class: 94V-2/94V-0
- Color: Natural/Black
- Unit: mm

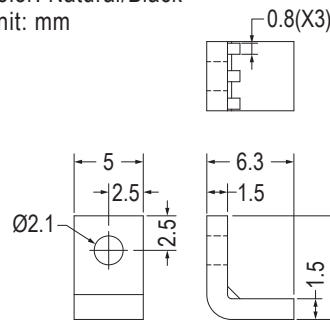

Part No.	Package
DELT-19	1000

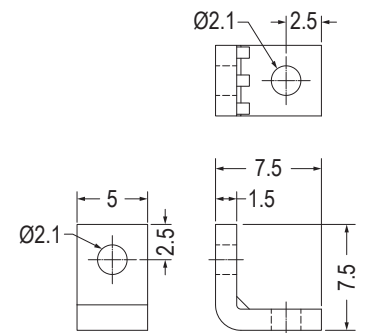

Part No.	Package
DELT-25	1000

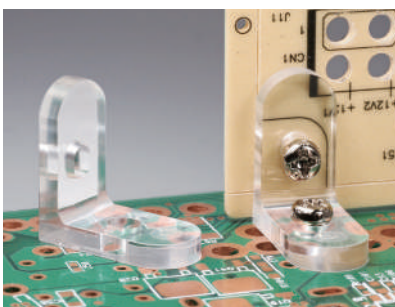

- Material: PC (UL)
- Flame Class: 94V-2
- Color: Transparent
- Unit: mm

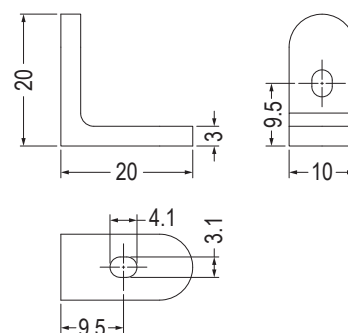

Part No.	Package
LPZA-1	1000



PC板間隔柱 SPACER SUPPORT

用途：用於散熱片之絕緣。

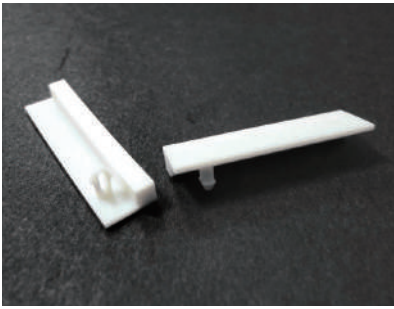

- Material: Nylon 66 (UL)
- Flame Class: 94V-2/94V-0
- Color: Natural/Black
- Unit: mm

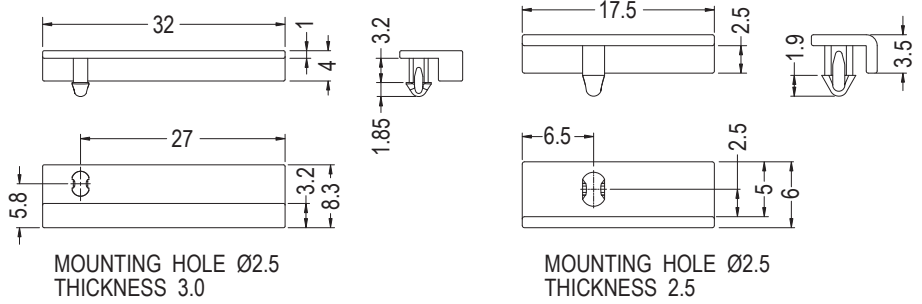

Part No.	Package
CGLF-32	1000

Part No.	Package
CGLE-18	1000



- Material: Nylon 66 (UL)
- Flame Class: 94V-2/94V-0
- Color: Natural/Black
- Unit: mm

用途：做為PC板與機板之絕緣。

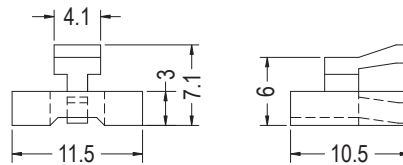

Part No.	Package
JYCE-1	1000

間隔柱 SPACER SUPPORT

用途：用於PC板與機板間之固定。

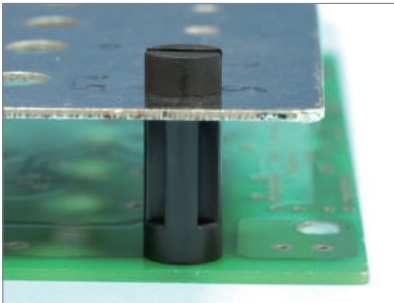

- Material: Nylon 66 (UL)
- Flame Class: 94V-2/94V-0
- Color: Natural/Black
- Unit: mm

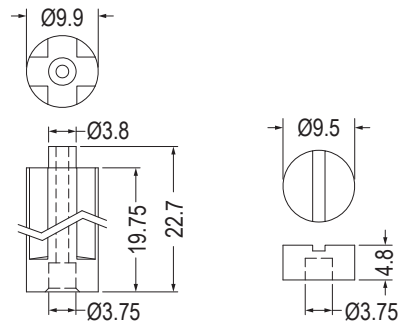

【 JYCE-2A 】

【 JYCE-2B 】

Part No.	Package
JYCE-2	500

圓體間隔柱 ROUND SPACER

用途：做為PC板與機板間之墊高與絕緣用。

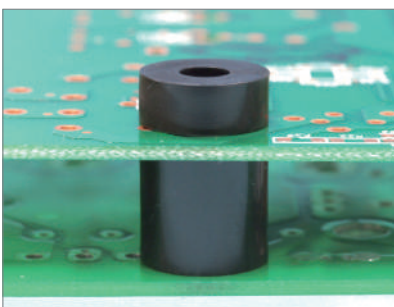

- Material: POM (UL)
- Flame Class: 94HB
- Color: Natural/Black
- Unit: mm

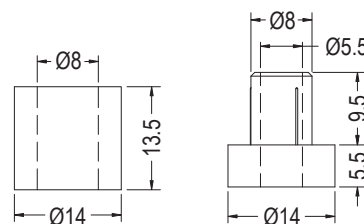

【 RXS-13.5 】

【 RXS-1 】

Part No.	Package
RXS-1	500
RXS-13.5	

圓體間隔柱 ROUND SPACER

用途：用於零件之絕緣使用，RSUA-1A 與RSUA-1B需配合使用。



- Material: POM (UL)
- Flame Class: 94HB
- Color: Black
- Unit: mm

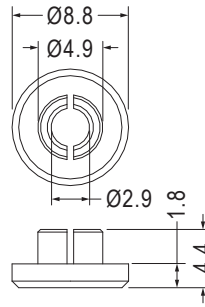

Part No.	Package
RSUA-1A	1000

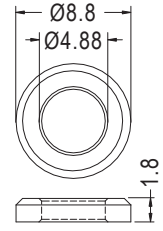

Part No.	Package
RSUA-1B	1000

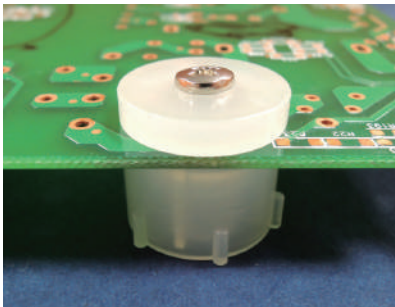

- Material: PC (UL)
- Flame Class: 94V-0
- Color: Natural
- Unit: mm

用途：做為PC板與機板間之墊高與固定。

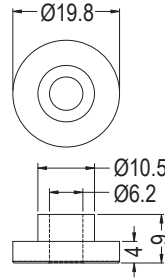

Part No.	Package
RLA-1	500

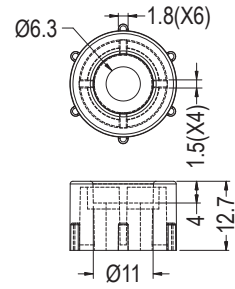

Part No.	Package
RLA-12.7	500

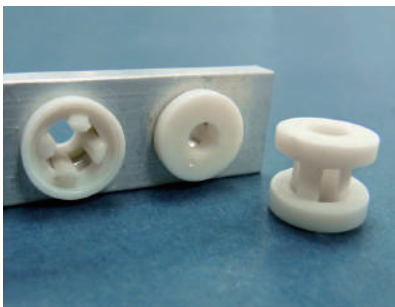

- Material: Nylon 66 (UL)
- Flame Class: 94V-2/94V-0
- Color: Natural/Black
- Unit: mm

用途：用於PC板與機板間之墊高與絕緣。

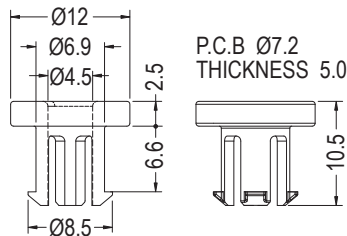

Part No.	Package
RML-1	1000

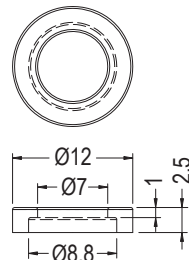

Part No.	Package
RML-25	1000

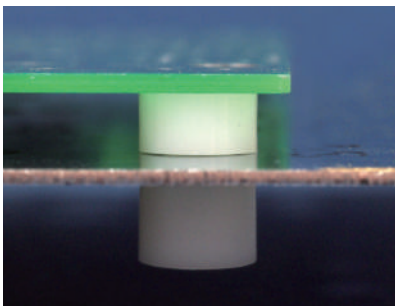

- Material: ABS (UL)
- Flame Class: 94HB
- Color: Natural
- Unit: mm

- Material: Nylon 66 (UL)
- Flame Class: 94V-2/94V-0
- Color: Natural
- Unit: mm

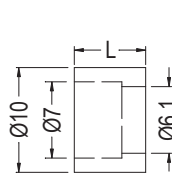

【 RMM- 】

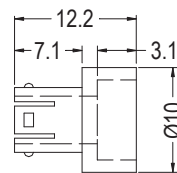

【 RMM-1 】

P.C.B Ø6.5
CHASSIS Ø4.0

Part No.	L	Package
RMM-1	RMM-75	7.5
	RMM-100	10.0
	RMM-150	15.0
		1000

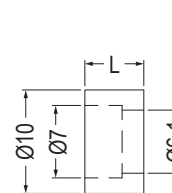

【 RMM- 】

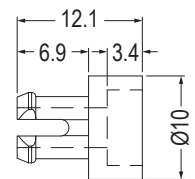

【 RMM-3 】

P.C.B Ø6.5
THICKNESS Ø2.4

Part No.	L	Package
RMM-3	RMM-57	5.7
	RMM-200	20.0
		1000

圓體間隔柱 ROUND SPACER

用途：用於PC板與機板間之墊高與絕緣。

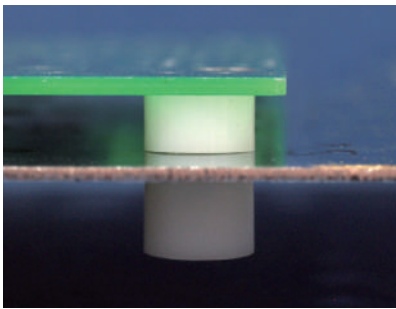

- Material: ABS (UL)
- Flame Class: 94HB
- Color: Natural
- Unit: mm

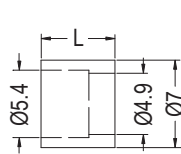

【 RSS- 】

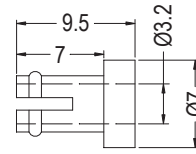

P.C.B Ø5.0
CHASSIS Ø3.5

【 RSS-1 】

- Material: Nylon 66 (UL)
- Flame Class: 94V-2/94V-0

Part No.	L	Package
RSS-60	6.0	1000
RSS-78	7.8	
RSS-105	10.5	
RSS-150	15.0	500
RSS-180	18.0	
RSS-200	20.0	
RSS-250	25.0	

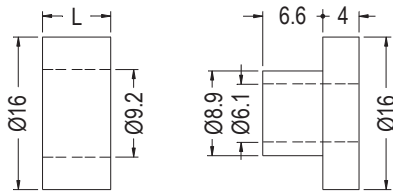

【 RXL- 】

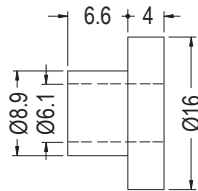

P.C.B Ø9.0
CHASSIS Ø6.0

【 RXL-1 】

Part No.	L	Package
RXL-5	5.0	500
RXL-7	7.5	
RXL-10	10.0	

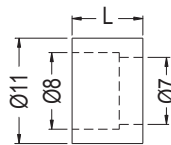

【 RLL- 】

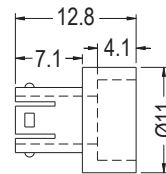

P.C.B Ø7.5
CHASSIS Ø4.5

【 RLL-1 】

Part No.	L	Package
RLL-57	5.7	1000
RLL-75	7.5	
RLL-100	10.3	500
RLL-150	15.0	1000
RLL-200	20.0	
RLL-254	25.4	

PC板間隔柱 SPACER SUPPORT

用途：做為PC板與機板之絕緣。

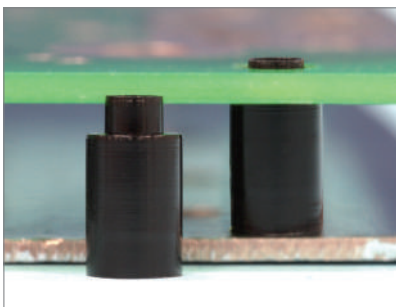

- Material: ABS (UL)
- Flame Class: 94HB
- Color: Natural/Black
- Unit: mm

- Material: POM
- Color: Black
- Unit: mm

- Material: N6T (UL)
- Flame Class: 94V-0
- Color: Black
- Unit: mm

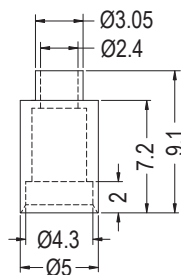

Part No.	Package
LASK-4	1000

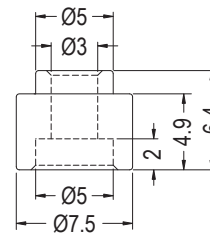

Part No.	Package
LASK-5	1000

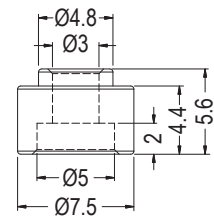

Part No.	Package
LASK-6	1000

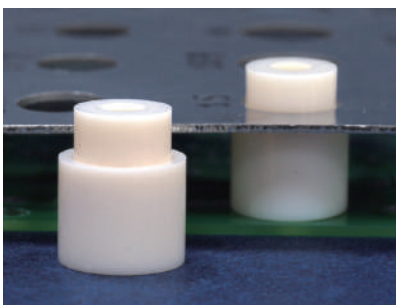

- Material: PC+ABS (UL)
- Flame Class: 94V-0
- Color: Natural
- Unit: mm

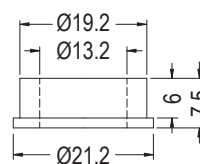

Part No.	Package
RCXL-1	1000

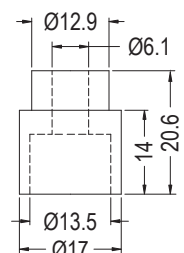

Part No.	Package
RCXL-14	1000

圓體間隔柱 ROUND SPACER

用途：做為板件與機板間之墊高與固定。

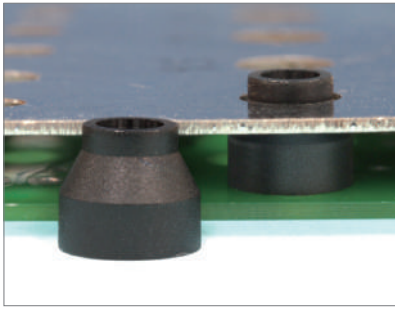

- Material: Nylon 66 (UL)
- Flame Class: 94V-2/94V-0
- Color: Natural/Black
- Unit: mm

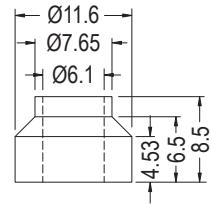
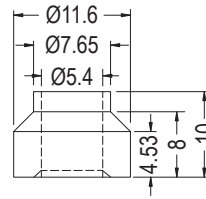

Part No.	Package
RC SL5-10	500

Part No.	Package
RC SL6-8.5	500

1



- Material: Nylon 6T (UL)
- Flame Class: 94V-0
- Color: Black
- Unit: mm

用途：做為螺絲或機板之絕緣用。

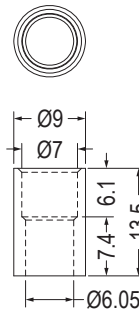

Part No.	Package
R7-13	1000

背膠式圓體間隔柱 ROUND SPACER WITH ADHESIVE TAPE

用途：背膠式，做為PC板之墊高。

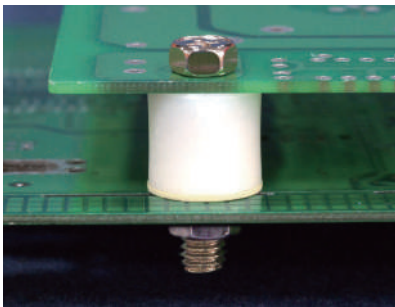

- Material: Nylon 66 (UL)
- Flame Class: 94V-2/94V-0
- Color: Natural/Black
- Unit: mm

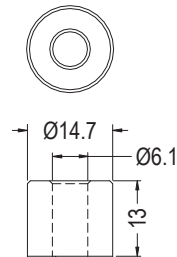

Part No.	Package
6-13A	1000

3M DOUBLE ADHESIVE TAPE

圓體間隔柱 ROUND SPACER

用途：做為PC板與機板之絕緣用。

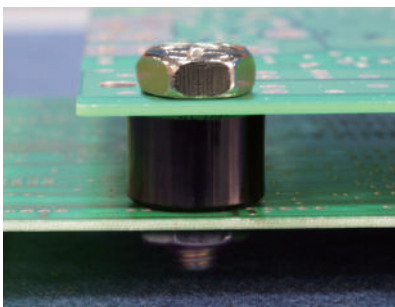

- Material: Nylon 66 (UL)
- Flame Class: 94V-2/94V-0
- Color: Natural/Black
- Unit: mm

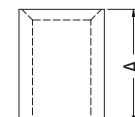
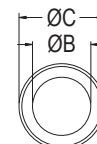
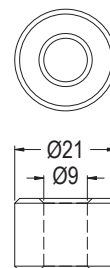

Part No.	Package
9-15	1000

Part No.	A	B	C	Package
KE3.5-2	2.0	3.5	6.3	2000
KE4.1-8	8.0	4.1	6.0	1000

圓體間隔柱 ROUND SPACER

用途：做為PC板與機板之絕緣用。



- Material: Nylon 66 (UL)
- Flame Class: 94V-2
- Color: Red
- Unit: mm

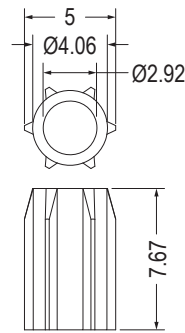

Part No.	Package
EM-733	2000

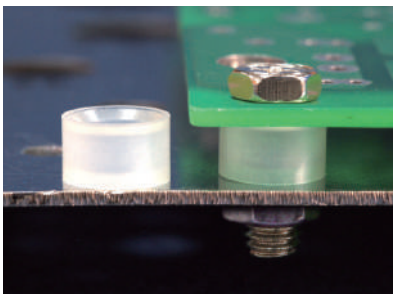

- Material: PC (UL)
- Flame Class: 94V-2/94V-0
- Color: Natural
- Unit: mm

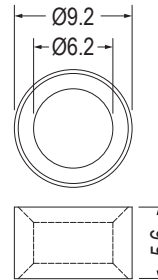

Part No.	Package
DELTA-3	1000

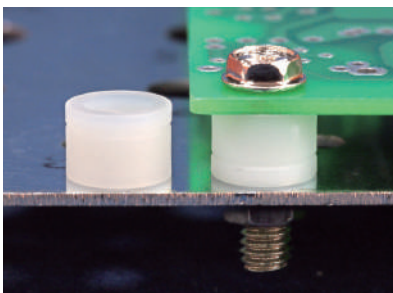

- Material: Nylon 66 (UL)
- Flame Class: 94V-2/94V-0
- Color: Natural/Black
- Unit: mm

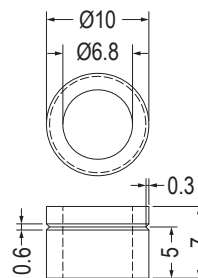

Part No.	Package
RR-1	1000

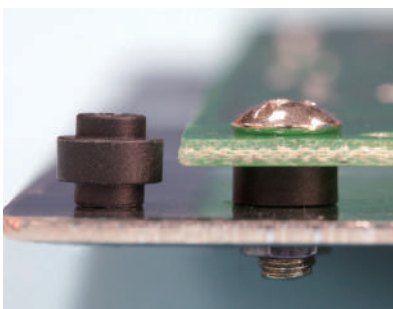

- Material: Nylon 6T (UL)
- Flame Class: 94V-0
- Color: Black
- Unit: mm

MOUNTING HOLE Ø4.5

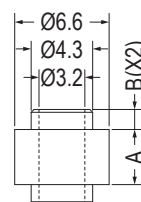

MOUNTING HOLE Ø4.5

Part No.	A	B	Package
LUS-2.7	2.7	1.5	1000
LUS-2.9	2.9	0.7	
LUS-3	3.0	0.7	
LUS-3.85	3.85	1.4	

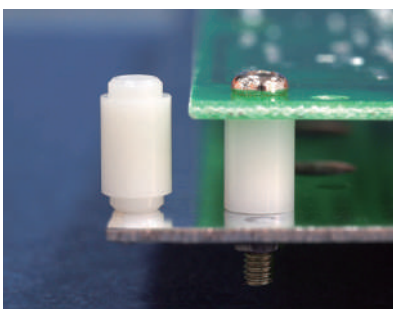

- Material: ABS (UL)
- Flame Class: 94HB
- Color: Natural
- Unit: mm

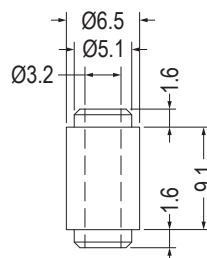

Part No.	Package
LUS-9.1	1000

- Material: Nylon 66 (UL)
- Flame Class: 94V-2/94V-0
- Color: Natural/Black
- Unit: mm

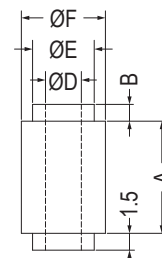

Part No.	A	B	D	E	F	Package
LUS-10	10.0	1.5	3.2	5.5	7.5	1000
LUS-74.5	74.5	1.0	6.5	8.0	10.0	500

圓體間隔柱 ROUND SPACER

用途：用於PC板與機板之絕緣。

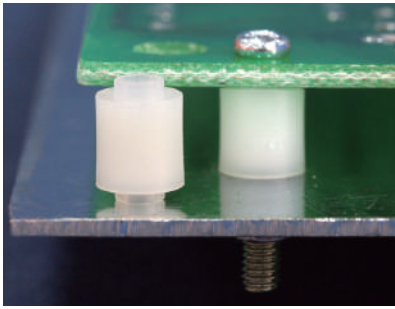

- Material: Nylon 66 (UL)
- Flame Class: 94V-2/94V-0
- Color: Natural/Black
- Unit: mm

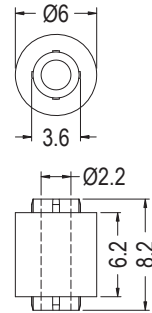

Part No.	Package
LUS2-8.2	1000

MOUNTING HOLE Ø3.5

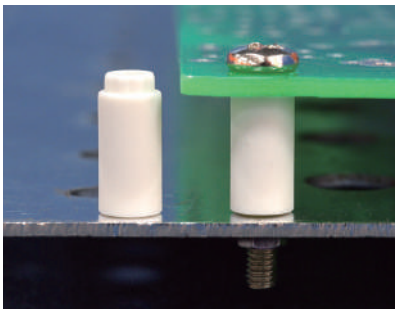

- Material: PBT (UL)
- Flame Class: 94V-0
- Color: Natural/Black
- Unit: mm

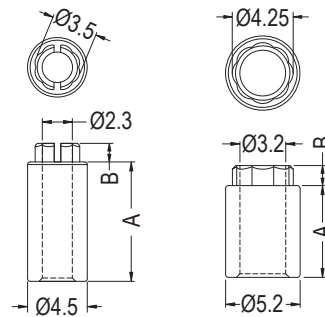

【 LUSS-6.2, LUSS-9 】

Part No.	A	B	Package
LUSS-6.2	6.2	1.0	1000
LUSS-6.4	6.4	1.4	
LUSS-7.1	7.07	1.4	
LUSS-9	9.0	1.4	
LUSS-9.4	9.43	1.4	
LUSS-10.1	10.06	1.4	

PC板間隔柱 SPACER SUPPORT

用途：PC板與PC板間之固定，不佔空間。

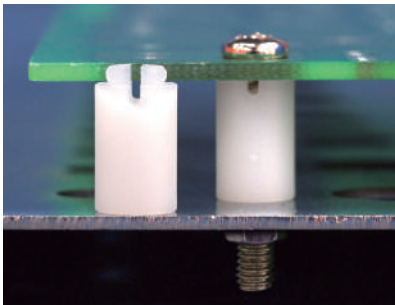

- Material: Nylon 66 (UL)
- Flame Class: 94V-2/94V-0
- Color: Natural/Black
- Unit: mm

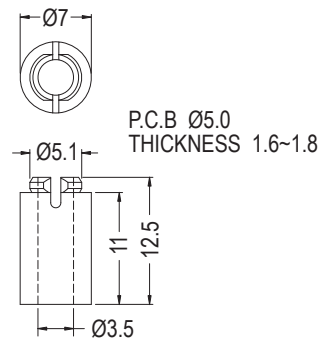

Part No.	Package
LUSA-11	1000

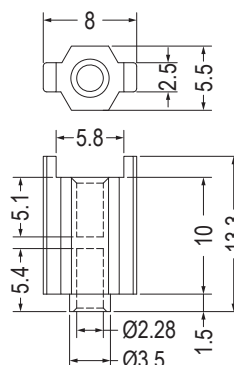
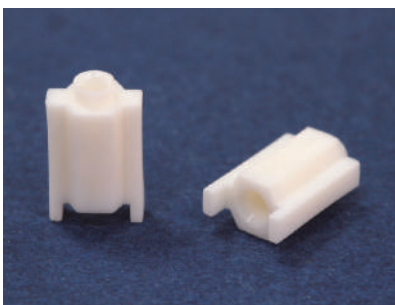

Part No.	Package
LUSB-10	1000

圓體間隔柱 ROUND SPACER

用途：做為PC板之墊高，尺寸齊全。

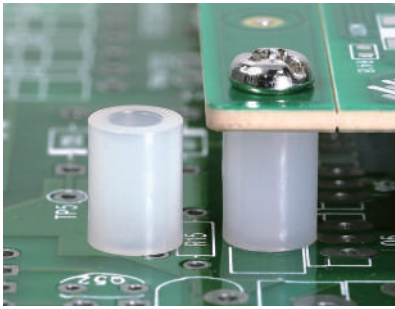

- Material: Nylon 66 (UL)/POM/TPE/PE/PC (UL)/ABS (UL)/PPS
- Flame Class: 94HB/94V-2/94V-0
- Color: Natural/Black
- Unit: mm

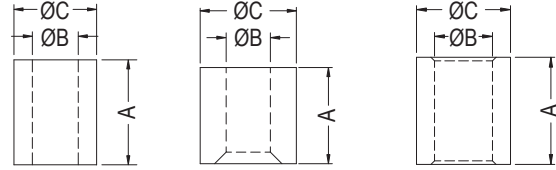

【 2.3-5, 2.3-5.5 】 【 4.9-4.5, 4.9-11.5, 4.9-13 】

Part No.	A(L)	B(ID)	C(OD)	Package	
0.7-1.6	1.6	0.7	2.0	1000	
0.7-3	3.0	0.71	2.2		
1.2-2.5	2.5	1.2	4.0		
1.2-3	3.0	1.2	3.2		
1.2-5	5.0	1.2	4.0		
1.2-6.35	6.35	1.2	3.2	2000	
1.2-7.6	7.6	1.2	4.0	1000	
1.4-3	3.0	1.4	3.5		
1.6-2	2.0	1.6	4.0		
1.6-4	4.0	1.6	4.0		
1.6-5.9	5.89	1.63	3.18		
1.7-11.3	11.3	1.7	3.0	1000	
2-3-1.9	1.9	2.02	3.0	2000	
2.05-3.5	3.5	2.05	3.0	1000	
2.1-2.1	2.1	2.1	2.4		
2.2-2.5	1.5	2.2	2.5	2000	
2.2-5	5.0	2.2	4.0	1000	
2.3-5	5.0	2.3	5.0		
2.3-5.5	5.5	2.3	5.0		
2.4-9.4	9.4	2.4	4.8		
2.5-2.15	2.15	2.5	4.0		
2.5-1655	16.0	2.5	5.5		
2.7-2.8	2.84	2.7	6.35		
2.7-6.7	6.71	2.7	6.35		
2.73-2.3	2.3	2.73	4.3		
2.8-3.8	3.8	2.8	4.3		
2.95-8	8.0	2.95	3.55		
3-25-6	25.0	3.0	6.0		
3.1-2	2.0	3.1	6.0		2000
3.1-2.2	2.2	3.1	8.0		
3.1-3.5	3.5	3.1	5.7		
★3.1-3.7	3.7	3.15	5.0		
3.1-4-6	4.0	3.1	6.0		
3.1-5	5.0	3.1	6.0	1000	
3.1-6	6.0	3.1	6.0		
★6-3.1-7.5	7.5	3.1	6.0		
3.1-7.5	7.5	3.1	8.0	2000	
3.1-8	8.0	3.1	6.0	1000	
3.1-3.8	3.85	3.15	5.0		
3.1-4	4.0	3.15	5.0		
3.2-2.2	2.2	3.2	5.5	2000	
3.2-2.5	2.5	3.2	4.2	1000	
3.2-3	3.0	3.2	5.8		
3.2-4.45	4.45	3.2	6.4		
3-5.8	5.85	3.2	5.0		
3.2-6.4	6.4	3.2	5.8		
6432-6.4	6.4	3.2	6.4		
3.2-6.8	6.8	3.2	4.5		
3.2-10	10.0	3.2	8.0		
3.35-5	5.0	3.35	8.0		
3.5-5.5	5.5	3.5	6.3		
3.55-10	10.0	3.55	6.0		

Part No.	A(L)	B(ID)	C(OD)	Package
3.55-31.8	31.8	3.55	6.35	1000
3.56-4.76	4.76	3.56	7.94	
3.56-9.53	9.53	3.56	6.35	
3.6-2	2.0	3.6	7.0	
3.6-19	19.0	3.6	8.0	
3.7-6.1	6.1	3.7	6.4	2000
3.7-9.5	9.5	3.73	6.35	1000
3.7-10	10.0	3.73	6.35	
3.8-0.5	0.5	3.8	5.3	2000
3.8-5.5	5.5	3.8	5.3	1000
3.9-5.3	5.3	3.9	8.0	
3.95-3.8	3.8	3.95	6.1	2000
4-4.8	4.8	4.0	7.5	
4.1-2.5	2.5	4.1	8.0	1000
4.2-2.4	2.4	4.2	7.5	2000
4.2-4.8	4.8	4.2	5.5	
4.2-8.5	8.5	4.2	10.0	1000
4.3-1.5	1.5	4.3	5.8	2000
4.3-5.5	5.5	4.3	5.8	
4.3-10.5	10.5	4.3	5.8	1000
4.3-15.5	15.5	4.3	5.8	
4.4-6	6.0	4.4	7.43	
4.4-6.4	6.4	4.4	9.5	2000
4.5-3.2	3.18	4.45	6.35	1000
4.5-2.75	2.75	4.5	6.0	
4.5-11	11.0	4.5	7.0	
4.5-11.5	11.5	4.5	7.0	
4.5-19.9	19.9	4.5	6.1	
4.7-3.5	3.5	4.7	6.0	1000
4.9-3	3.0	4.9	7.94	
4.9-4.5	4.5	4.9	7.94	
4.9-11.5	11.5	4.9	7.94	
4.9-13	13.0	4.9	7.94	
5-3.5	3.5	5.0	9.0	2000
5-4	4.0	5.0	12.0	
5-4.2	4.2	5.0	7.0	
5-6.5L	6.5	5.0	9.5	
5-7.9L	7.9	5.0	9.5	
5-38.1	38.1	5.0	7.9	1000
5-40	40.0	5.0	9.0	500
5.1-12.7	12.7	5.1	9.5	1000
5.2-2	2.0	5.2	6.8	
5.2-2.3	2.3	5.2	6.8	
5.2-3	3.0	5.2	6.8	
5.2-4.1	4.1	5.2	6.8	
5.2-6	6.0	5.2	10.0	
5.2-7.5	7.5	5.2	7.6	
5.2-11	11.0	5.2	7.6	
5.2-13	13.0	5.2	6.8	
★5.3-2.8	2.8	5.3	8.5	
5.4-122	122.0	5.4	9.53	250
5.5-4	4.0	5.5	15.0	1000

圓體間隔柱 ROUND SPACER

用途：做為PC板之墊高，尺寸齊全。

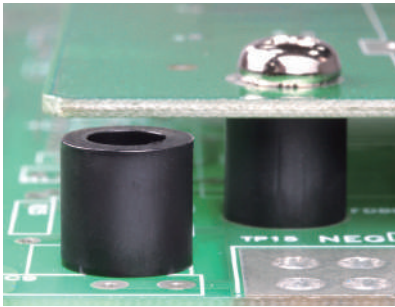

- Material: Nylon 66 (UL)/POM/TPE/PE/PC (UL)/ABS (UL)/PPS
- Flame Class: 94HB/94V-2/94V-0
- Color: Natural/Black
- Unit: mm

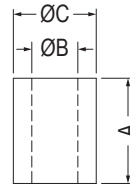

Part No.	A(L)	B(ID)	C(OD)	Package	
5.55-11.8	11.8	5.55	7.0	1000	
5-5	5.0	5.6	8.6		
5-6	6.0	5.6	8.6		
5-7.9	7.9	5.6	8.6		
5-8	8.0	5.6	8.6		
5-8.8	8.8	5.6	8.6		
5-11.8	11.8	5.6	8.6		
5-14	14.0	5.6	8.6		
5-16.5	16.5	5.6	8.6		
5-16.7	16.7	5.6	8.6		
5-17	17.0	5.6	8.6		
5-20	20.0	5.6	8.6		250
5.7-12.9	12.9	5.7	7.7		1000
5.7-14.1	14.1	5.7	7.7		
5.8-4.9	4.9	5.8	7.3		2000
5.8-14.4	14.4	5.8	7.3		
6-6	6.0	6.0	10.0	250	
6-22	22.0	6.0	15.0		
6.2-6S	6.0	6.2	10.0	1000	
★6.2-10	10.0	6.2	10.4		
6.2-12	12.0	6.2	10.4		
6.3-5	5.0	6.3	15.0	250	
6.3-20	20.0	6.3	12.7		
★6.35-3.2	3.2	6.35	9.1	1000	
6.35-7.1	7.1	6.35	8.0		
6.4-3	3.0	6.4	12.0	500	
6.4-10	10.0	6.4	20.0		
6.5-3	3.0	6.5	9.2	1000	
6-4.2	4.2	6.6	10.6		

Part No.	A(L)	B(ID)	C(OD)	Package	
6-4.8	4.8	6.6	9.1	1000	
6-16	15.7	6.6	9.1		
6.8-5	5.0	6.8	10.0		
6.9-12.7	12.7	6.9	12.7		
7-5.5	5.5	7.0	13.0		
7-8.7	8.7	7.0	10.0		
7.5-8.9	8.9	7.5	10.0		
7.5-29	29.0	7.5	11.0		250
8-16	15.7	8.1	10.7		1000
8.2-5.5	5.5	8.2	12.0		
★8.2-80	80.0	8.2	10.0	250	
8.4-5	5.0	8.4	16.0	1000	
8.5-4.6	4.6	8.5	10.3		
8.5-612	6.0	8.5	12.0		
8.5-8	7.9	8.5	11.0		
★9-2.5	2.5	9.0	15.0		
★9-4	4.0	9.0	15.0		
★9-10.5	10.5	9.0	15.0		
9.1-7.5	7.5	9.1	17.9		
9.25-4	4.0	9.25	12.25		
9.5-34	34.0	9.5	19.0		250
10-6	6.0	10.0	12.0		
1012-26	26.0	10.0	12.0	1000	
12-19	19.0	12.0	14.0		
12.4-5	5.0	12.4	22.0	250	
12.8-35	35.0	12.8	22.0		
13-5	5.0	13.0	24.0	500	
20.5-9.5	9.5	20.5	25.5		
29-16	16.0	29.5	33.5	250	

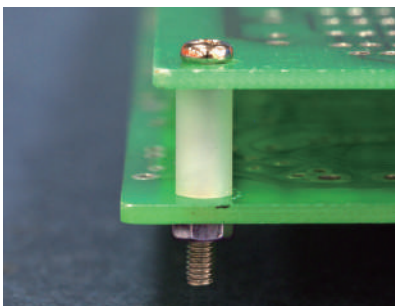

- Material: Nylon 66 (UL)/PBT (UL)
- Flame Class: 94V-2/94V-0
- Color: Natural/Black
- Unit: mm

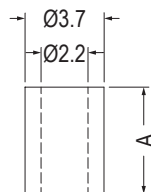

Part No.	A(L)	Package
2-1.8	1.8	2000
2-2	2.0	
2-2.5	2.5	
2-3	3.0	
2-3.2	3.2	
2-4	4.0	
2-4.3	4.3	
2-5	5.0	
2-5.3	5.3	
2-6	6.0	
2-7	7.0	

Part No.	A(L)	Package
2-8	8.0	2000
2-9	9.0	
2-9.5	9.5	
2-10	10.0	
2-11	11.0	
2-12	12.0	
2-13	13.0	
2-14	14.0	
2-15	15.0	
2-16	16.0	

圓體間隔柱 ROUND SPACER

用途：做為PC板之墊高，尺寸齊全。

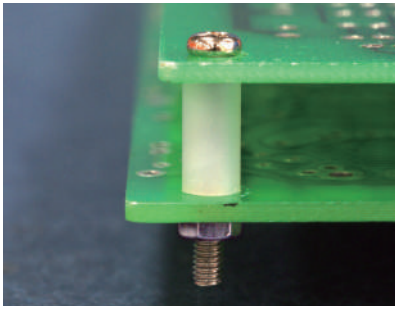

- Material: Nylon 66 (UL)/PBT (UL)
- Flame Class: 94V-2/94V-0
- Color: Natural/Black
- Unit: mm

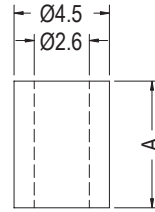

Part No.	A(L)	Package
2.6-2	2.0	2000
2.6-3	3.0	
2.6-4	4.0	
2.6-5	5.0	
2.6-6	6.0	
2.6-7	7.0	
2.6-8	8.0	
2.6-9	9.0	
2.6-10	10.0	
2.6-11	11.0	
2.6-12	12.0	
2.6-13	13.0	
2.6-14	14.0	
2.6-15	15.0	
2.6-16	16.0	

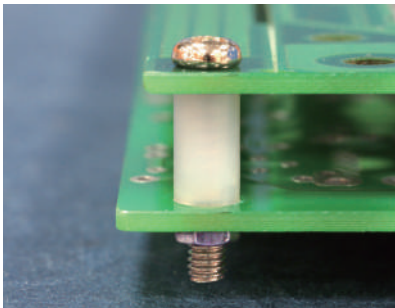

- Material: Nylon 66 (UL)
- Flame Class: 94V-2/94V-0
- Color: Natural/Black
- Unit: mm

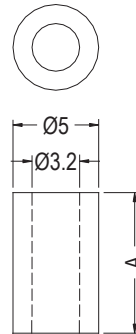

Part No.	A(L)	Package
3-1.5	1.5	2000
3-2	2.0	
3-2.5	2.5	
3-3	3.0	
3-3.3	3.3	
3-3.5	3.5	
3-4	4.0	
3-4.2	4.2	
3-4.5	4.5	
3-5	5.0	
3-5.1	5.05	
3-5.5	5.5	
3-6	6.0	
3-6.35	6.35	
3-7	7.0	
3-7.5	7.5	
3-8	8.0	
3-9	9.0	
3-9.5	9.5	
3-10	10.0	
3-10.5	10.5	
3-11	11.0	
3-12	12.0	

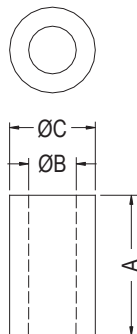

Part No.	A(L)	B(ID)	C(OD)	Package
3-20L	20.0	3.2	6.0	1000
3-38.1	38.1	3.05	6.35	

Part No.	A(L)	Package
3-13	13.0	1000
3-13.6	13.6	
3-14	14.0	
3-15	15.0	
3-15.5	15.5	
3-16	16.0	
3-16.5	16.5	
3-16.8	16.8	
3-17	17.0	
3-17.5	17.5	
3-18	18.0	
3-19	19.0	
3-20	20.0	
3-21	21.0	
3-22	22.0	
3-23	23.0	
3-24	24.0	
3-25	25.0	
3-26	26.0	
3-27	27.0	
3-28	28.0	
3-29	29.0	
3-30	30.0	
3-35	35.0	



圓體間隔柱 ROUND SPACER

用途：做為PC板之墊高，尺寸齊全。

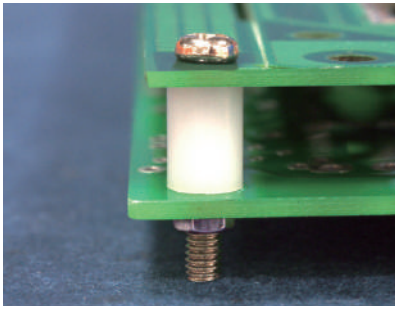

- Material: Nylon 66 (UL)
- Flame Class: 94V-2/94V-0
- Color: Natural/Black
- Unit: mm

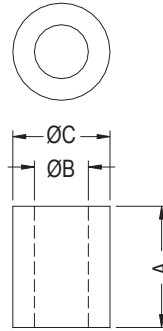

Part No.	A(L)	B(ID)	C(OD)	Package
3.5-1.6	1.6	3.5	6.3	2000
3.5-2	2.0	3.5	6.3	
3.5-3	3.0	3.5	6.3	
3.5-3.5	3.5	3.5	6.3	
3.5-4	4.0	3.5	6.3	
3.5-4.5	4.5	3.5	6.3	
3.5-5	5.0	3.5	6.3	
3.5-6	6.0	3.5	6.3	
3.5-6.4	6.4	3.5	6.3	
3.5-7	7.0	3.5	6.3	
3.5-7.5	7.5	3.5	6.3	
3.5-8	8.0	3.5	6.3	
3.5-9	9.0	3.5	6.3	
3.5-9.5	9.5	3.5	6.3	
3.5-10	10.0	3.5	6.3	
3.5-11	11.0	3.5	6.3	
3.5-12	12.0	3.5	6.3	
3.5-12.7	12.7	3.5	6.3	
3.5-13	13.0	3.5	6.3	
3.5-14	14.0	3.5	6.3	
3.5-15	15.0	3.5	6.3	
3.5-15.5	15.5	3.5	6.3	
3.5-16	16.0	3.5	6.3	
3.5-17	17.0	3.5	6.3	
3.5-17.7	17.7	3.5	6.3	
3.5-18	18.0	3.5	6.3	
3.5-19	19.0	3.5	6.3	
3.5-20	20.0	3.5	6.3	
3.5-21	21.0	3.7	6.3	
3.5-22	22.0	3.7	6.3	
3.5-23	23.0	3.7	6.3	
3.5-24	24.0	3.7	6.3	
3.5-25	25.0	3.7	6.3	
3.5-26	26.0	3.7	6.3	
3.5-27	27.0	3.7	6.3	
3.5-28	28.0	3.7	6.3	
3.5-28.5	28.57	3.55	6.35	
3.5-29	29.0	3.7	6.3	
3.5-30	30.0	3.7	6.3	
3.5-35	35.0	3.7	6.3	

Part No.	A(L)	B(ID)	C(OD)	Package
4-2	2.0	4.2	6.3	2000
4-3	3.0	4.2	6.3	
4-3.4	3.4	4.2	6.3	
4-3.5	3.5	4.2	6.3	
4-4	4.0	4.2	6.3	
4-4.83	4.83	4.2	6.3	
4-5	5.0	4.2	6.3	
4-6	6.0	4.2	6.3	
4-7	7.0	4.2	6.3	
4-7.5	7.5	4.2	6.3	
4-8	8.0	4.2	6.3	
4-8.5	8.5	4.2	6.3	
4-9	9.0	4.2	6.3	
4-9.5	9.5	4.2	6.3	
4-10	10.0	4.2	6.3	
4-11	11.0	4.2	6.3	
4-12	12.0	4.2	6.3	
4-12.7	12.7	4.2	6.3	
4-13	13.0	4.2	6.3	
4-14	14.0	4.2	6.3	
4-15	15.0	4.2	6.3	
4-16	16.0	4.2	6.3	
4-17	17.0	4.2	6.3	
4-18	18.0	4.2	6.3	
4-19	19.0	4.2	6.3	
4-20	20.0	4.2	6.3	
4-21	21.0	4.2	6.3	
4-22	22.0	4.2	6.3	
4-23	23.0	4.2	6.3	
4-24	24.0	4.2	6.3	
4-25	25.0	4.2	6.3	
4-26	26.0	4.2	6.3	
4-27	27.0	4.2	6.3	
4-28	28.0	4.2	6.3	
4-28.7	28.7	4.2	6.3	
4-29	29.0	4.2	6.3	
4-30	30.0	4.2	6.3	
4-40	40.0	4.2	6.3	
4-45	45.0	4.2	6.3	

間隔柱 SPACER SUPPORT

用途：做為PC板與PC板或機板間之固定不掉落。

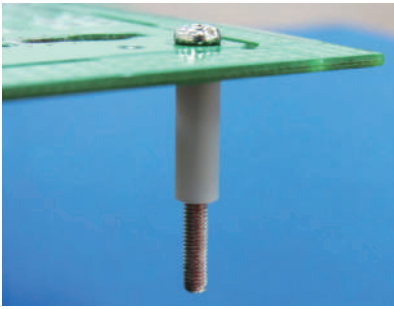

- Material: Nylon 66 (UL)
- Flame Class: 94V-2/94V-0
- Color: Natural/Black
- Unit: mm

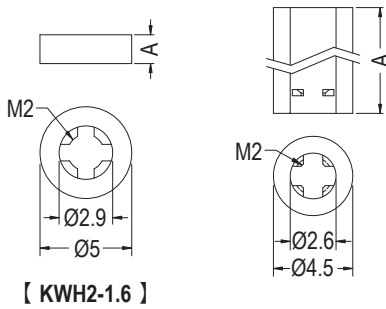

Part No.	A	Package
KWH2-1.6	1.57	2000
KWH2-2	2.0	
KWH2-3	3.0	
KWH2-3.5	3.5	
KWH2-4	4.0	
KWH2-5	5.0	
KWH2-6	6.0	
KWH2-6.3	6.3	
KWH2-7	7.0	
KWH2-8	8.0	
KWH2-9	9.0	
KWH2-9.5	9.5	
KWH2-10	10.0	
KWH2-11	11.0	
KWH2-11.5	11.5	
KWH2-12	12.0	
KWH2-12.7	12.7	
KWH2-13	13.0	
KWH2-14	14.0	

Part No.	A	Package
KWH2-15	15.0	2000
KWH2-15.9	15.9	
KWH2-16	16.0	
KWH2-17	17.0	
KWH2-18	18.0	
KWH2-19	19.0	
KWH2-20	20.0	1000
KWH2-21	21.0	
KWH2-22	22.0	
KWH2-23	23.0	
KWH2-24	24.0	
KWH2-25	25.0	
KWH2-25.4	25.4	
KWH2-26	26.0	
KWH2-27	27.0	
KWH2-28	28.0	
KWH2-29	29.0	
KWH2-30	30.0	

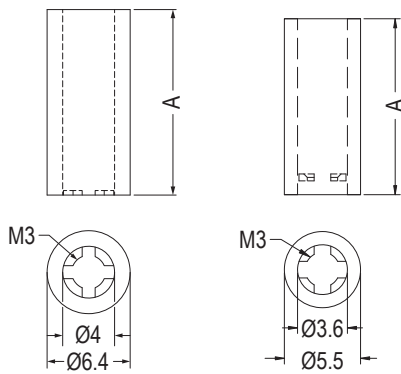

Part No.	A	Package
KWH3-1.5	1.5	2000
KWH3-2	2.0	
KWH3-3	3.0	
KWH3-3.2L	3.2	
KWH3-3.5	3.5	
KWH3-4	4.0	
KWH3-5	5.0	
KWH3-6	6.0	
KWH3-6.3	6.3	
KWH3-7	7.0	
KWH3-8	8.0	
KWH3-9	9.0	
KWH3-9.5	9.5	
KWH3-10	10.0	
KWH3-11	11.0	
KWH3-11.5	11.5	
KWH3-12	12.0	
KWH3-12.7	12.7	
KWH3-13	13.0	

Part No.	A	Package
KWH3-14	14.0	1000
KWH3-14.3L	14.3	
KWH3-15	15.0	
KWH3-15.9	15.9	
KWH3-16	16.0	
KWH3-17	17.0	
KWH3-18	18.0	
KWH3-19	19.0	
KWH3-20	20.0	
KWH3-21	21.0	
KWH3-22	22.0	
KWH3-23	23.0	
KWH3-24	24.0	
KWH3-25	25.0	
KWH3-25.4	25.4	
KWH3-26	26.0	
KWH3-27	27.0	
KWH3-28	28.0	
KWH3-29	29.0	
KWH3-30	30.0	

間隔柱 SPACER SUPPORT

用途：做為PC板與PC板或機板間之固定
不掉落。

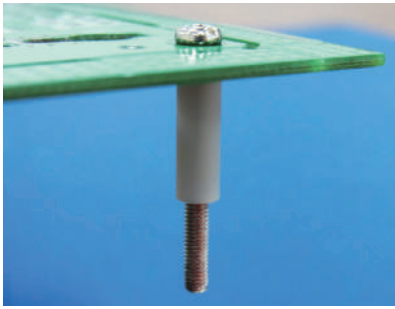

- Material: Nylon 66 (UL)
- Flame Class: 94V-2/94V-0
- Color: Natural/Black
- Unit: mm

1

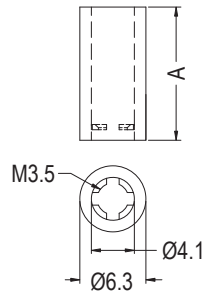

Part No.	A	Package
KWH3.5-2	2.0	2000
KWH3.5-3	3.0	
KWH3.5-4	4.0	
KWH3.5-5	5.0	
KWH3.5-6	6.0	
KWH3.5-6.3	6.3	
KWH3.5-7	7.0	
KWH3.5-8	8.0	
KWH3.5-9	9.0	
KWH3.5-10	10.0	
KWH3.5-11	11.0	
KWH3.5-12	12.0	
KWH3.5-12.7	12.7	
KWH3.5-13	13.0	
KWH3.5-14	14.0	
KWH3.5-15	15.0	
KWH3.5-15.9	15.9	

Part No.	A	Package
KWH3.5-16	16.0	2000
KWH3.5-17	17.0	
KWH3.5-18	18.0	
KWH3.5-19	19.0	
KWH3.5-20	20.0	
KWH3.5-21	21.0	1000
KWH3.5-22	22.0	
KWH3.5-23	23.0	
KWH3.5-24	24.0	
KWH3.5-25	25.0	
KWH3.5-25.4	25.4	
KWH3.5-26	26.0	
KWH3.5-27	27.0	
KWH3.5-28	28.0	
KWH3.5-29	29.0	
KWH3.5-30	30.0	

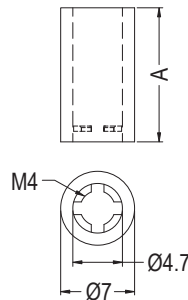
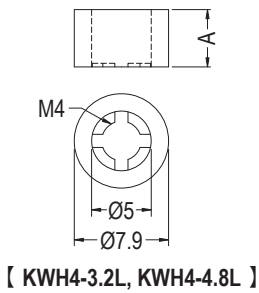

Part No.	A	Package
KWH4-2	2.0	2000
KWH4-3	3.0	
KWH4-3.2L	3.2	
KWH4-4	4.0	
KWH4-4.8L	4.8	
KWH4-5	5.0	
KWH4-6	6.0	
KWH4-6.3	6.3	
KWH4-7	7.0	
KWH4-8	8.0	
KWH4-9	9.0	
KWH4-9.5L	9.5	
KWH4-10	10.0	
KWH4-11	11.0	
KWH4-12	12.0	
KWH4-12.7	12.7	
KWH4-13	13.0	
KWH4-14	14.0	

Part No.	A	Package
KWH4-15	15.0	2000
KWH4-15.9	15.9	
KWH4-16	16.0	
KWH4-17	17.0	
KWH4-18	18.0	
KWH4-19	19.0	1000
KWH4-20	20.0	
KWH4-21	21.0	
KWH4-22	22.0	
KWH4-23	23.0	
KWH4-24	24.0	
KWH4-25	25.0	
KWH4-25.4	25.4	
KWH4-26	26.0	
KWH4-27	27.0	
KWH4-28	28.0	
KWH4-29	29.0	
KWH4-30	30.0	

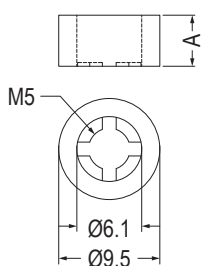
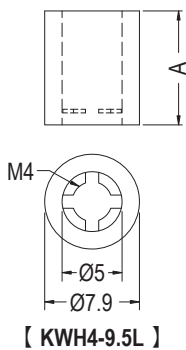

Part No.	A	Package
KWH5-3.2	3.2	2000
KWH5-4.8	4.8	
KWH5-6.4	6.4	1000
KWH5-7.9	7.9	
★KWH5-9.5	9.5	

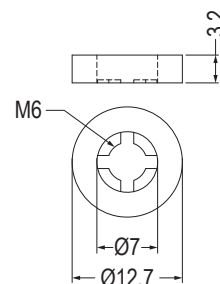

Part No.	Package
KWH6-3.2	1000

間隔柱 SPACER SUPPORT

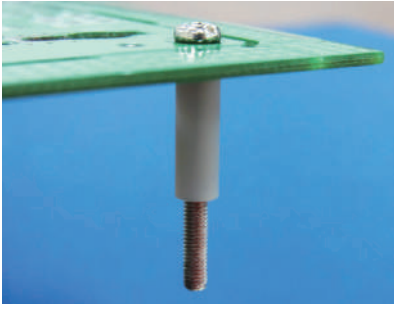

- Material: Nylon 66 (UL)
- Flame Class: 94V-2/94V-0
- Color: Natural/Black
- Unit: mm

用途：做為PC板與PC板或機板間之固定，不掉落。

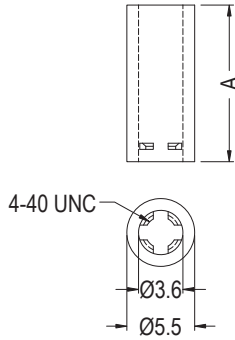

Part No.	A	Package
KWH440-2	2.0	2000
KWH440-3	3.0	
KWH440-4	4.0	
KWH440-5	5.0	
KWH440-6	6.0	
KWH440-6.3	6.3	
KWH440-7	7.0	
KWH440-8	8.0	
KWH440-9	9.0	
KWH440-9.5	9.5	
KWH440-10	10.0	
KWH440-11	11.0	
KWH440-12	12.0	
KWH440-12.7	12.7	
KWH440-13	13.0	
KWH440-14	14.0	
KWH440-15	15.0	

Part No.	A	Package
KWH440-15.9	15.9	2000
KWH440-16	16.0	
KWH440-17	17.0	
KWH440-18	18.0	
KWH440-19	19.0	
KWH440-20	20.0	1000
KWH440-21	21.0	
KWH440-22	22.0	
KWH440-23	23.0	
KWH440-24	24.0	
KWH440-25	25.0	
KWH440-25.4	25.4	
KWH440-26	26.0	
KWH440-27	27.0	
KWH440-28	28.0	
KWH440-29	29.0	
KWH440-30	30.0	

銅柱 STANDOFF

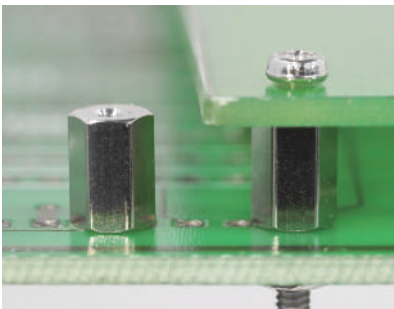

- Material: Brass
- Finish: Nickel Plated
- Unit: mm

用途：做為PC板與機板間之固定，六角型不滑動。

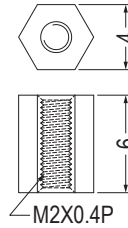

Part No.	Package
BHP2-6	1000

塑膠銅柱 STANDOFF

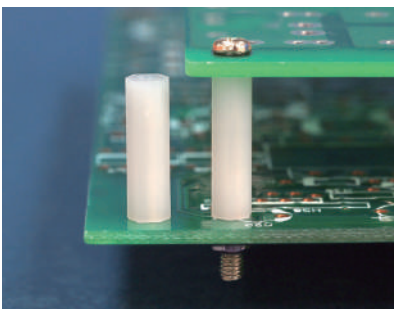

- Material: Nylon 66 (UL)
- Flame Class: 94V-2/94V-0
- Color: Natural/Black
- Unit: mm

用途：做為PC板與機板間之固定，六角型不滑動。

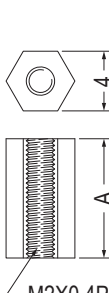

Part No.	A	Package
HPS2-4	4.0	1000
HPS2-4.5	4.5	
HPS2-5	5.0	
HPS2-6	6.0	
HPS2-7	7.0	
HPS2-8	8.0	
HPS2-9	9.0	
HPS2-10	10.0	
HPS2-11	11.0	
HPS2-12	12.0	
HPS2-12.7	12.7	

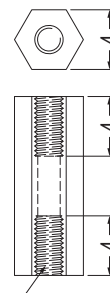

Part No.	A	Package
HPS2-13	13.0	1000
HPS2-14	14.0	
HPS2-15	15.0	
HPS2-16	16.0	
HPS2-17	17.0	
HPS2-18	18.0	
HPS2-19	19.0	
HPS2-20	20.0	
HPS2-21	21.0	
HPS2-22	22.0	
HPS2-23	23.0	
HPS2-24	24.0	
HPS2-25	25.0	

塑膠銅柱 STANDOFF

1

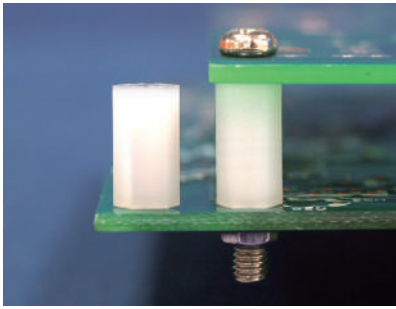

- Material: Nylon 66 (UL)
- Flame Class: 94V-2/94V-0
- Color: Natural/Black
- Unit: mm

用途：做為PC板與機板間之固定，六角型不滑動。

Part No.	A	Package
HP2-4	4.0	1000
HP2-5	5.0	
HP2-6	6.0	
HP2-7	7.0	
HP2-8	8.0	
HP2-9	9.0	
HP2-10	10.0	
HP2-11	11.0	
HP2-12	12.0	

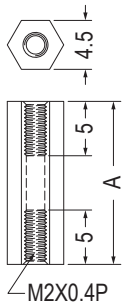
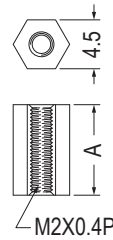

Part No.	A	Package
HP2-13	13.0	1000
HP2-14	14.0	
HP2-15	15.0	
HP2-16	16.0	
HP2-17	17.0	
HP2-18	18.0	
HP2-18.8	18.8	
HP2-19	19.0	

Part No.	A	Package
HP2-20	20.0	1000
HP2-21	21.0	
HP2-22	22.0	
HP2-23	23.0	
HP2-24	24.0	
HP2-25	25.0	
HP2-26	26.0	
HP2-27	27.0	
HP2-28	28.0	

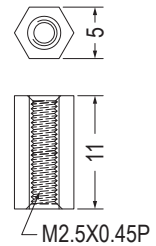

Part No.	Package
HPS2.5-11	1000

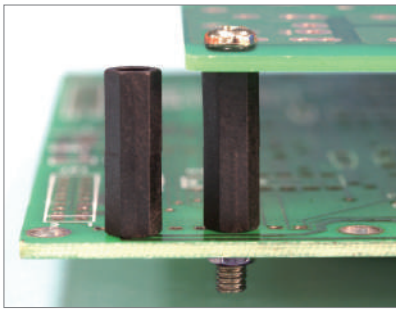

- Material: Nylon 6 (UL)
- Flame Class: 94HB
- Color: Black
- Unit: mm

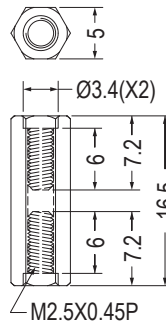

Part No.	Package
HPS2.5-16.5	1000

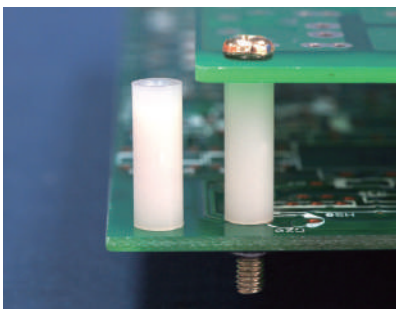

- Material: Nylon 66 (UL)
- Flame Class: 94V-2/94V-0
- Color: Natural/Black
- Unit: mm

用途：做為PC板與機板間之固定。

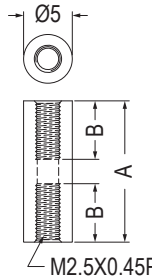

Part No.	A	B	Package
HPP25-14.5	14.5	6.0	1000
HPP25-20	20.0	9.0	

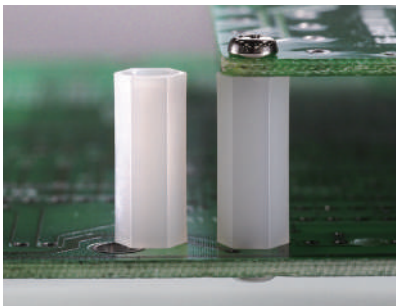

- Material: Nylon 66 (UL)
- Flame Class: 94V-2/94V-0
- Color: Natural/Black
- Unit: mm

用途：做為PC板與機板間之固定，六角型不滑動。

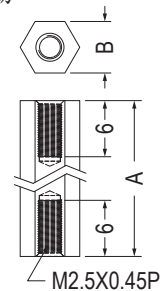
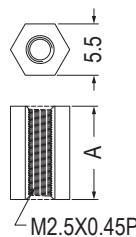

Part No.	A	Package
HP2.5-8	8.0	1000
HP2.5-10	10.0	

Part No.	A	B	Package
★HP2.5-15	15.0	5.5	1000
★HP2.5-15S	15.0	4.0	
★HP2.5-25	25.0	5.5	
★HP2.5-25S	25.0	4.0	
HP2.5-31	31.0	5.5	

塑膠銅柱 STANDOFF

用途：做為PC板與機板間之固定，六角型不滑動。

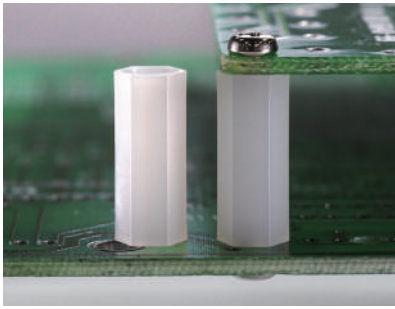

- Material: Nylon 66 (UL)
- Flame Class: 94V-2/94V-0
- Color: Natural/Black
- Unit: mm

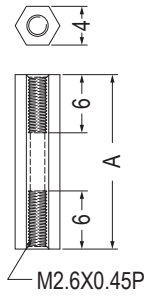

Part No.	A	Package
HPS2.6-18	18.0	1000
HPS2.6-19	19.0	
HPS2.6-31.75	31.75	

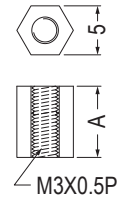

Part No.	A	Package
HPS-6	6.0	1000
HPS-8	8.0	
HPS-10	10.0	
HPS-12	12.0	

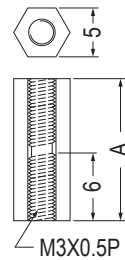
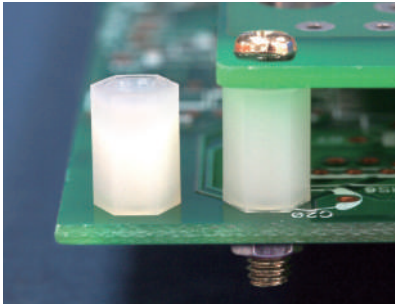

Part No.	A	Package
HPS-15	15.0	1000
HPS-17.4	17.4	
HPS-18	18.0	
HPS-20	20.0	
HPS-25	25.0	

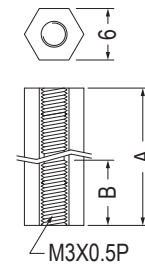
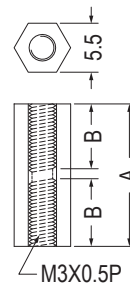
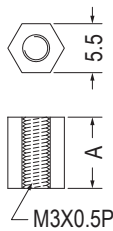

• 產品兩端皆有螺牙可供鎖付

【HP-34】

Part No.	A	Package
HP-4	4.0	1000
HP-5	5.0	
HP-6	6.0	
HP-6.3	6.35	
HP-7	7.0	
HP-8	8.0	
HP-8.5	8.5	
HP-9	9.0	
HP-9.5	9.5	
HP-10	10.0	
HP-10.5	10.5	
HP-11	11.0	
HP-12A	12.0	
HP-12	12.7	

Part No.	A	B	Package
HP-13.5	13.5	6.0	1000
HP-14	14.0	6.0	
HP-14.5	14.5	6.0	
HP-15	15.0	6.0	
HP-15.5	15.5	6.0	
HP-16	16.0	6.0	
HP-16.5	16.5	6.0	
HP-17	17.0	6.0	
HP-17.5	17.5	6.0	
HP-18	18.0	6.0	
HP-19	19.0	6.0	
HP-20	20.0	6.0	
HP-21.5	21.5	6.0	
HP-22	22.0	6.0	

Part No.	A	B	Package
HP-24	24.0	6.0	1000
HP-25	25.0	6.0	
HP-26	26.0	6.0	
HP-27	27.0	6.0	
HP-28	28.0	6.0	
HP-28.6	28.6	6.0	
HP-30	30.0	6.0	
HP-30.8	30.8	6.0	
HP-32	32.0	6.0	
HP-34	34.0	8.0	
HP-35	35.0	6.0	500
HP-37	37.0	6.0	
HP-38	38.0	6.0	
HP-40	40.0	6.0	
HP-42	42.0	6.0	
HP-45	45.0	6.0	
HP-47	47.0	6.0	
HP-49	49.0	6.0	
HP-50	50.0	6.0	
HP-52	52.0	6.0	
HP-54	54.0	6.0	
HP-55.5	55.5	8.0	
HP-60.2	60.2	6.0	
HP-70	70.0	10.0	
HP-76.7	76.7	8.5	

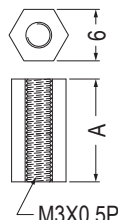

Part No.	A	Package
HPH-10	10.0	1000
HPH-12	12.0	
HPH-15	15.0	



塑膠銅柱 STANDOFF

用途：做為PC板與機板間之固定，六角型不滑動。

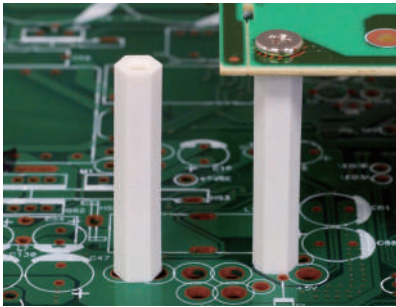

- Material: Nylon 66 (UL)
- Flame Class: 94V-2/94V-0
- Color: Natural/Black
- Unit: mm

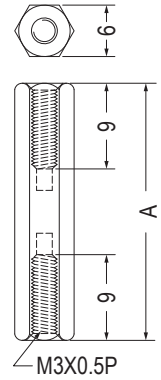
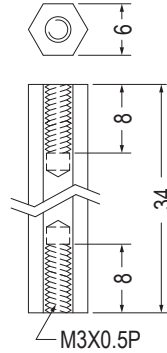

Part No.	Package
HPL-30	1000
HPH-34	500

Part No.	A	Package
HPL-30	30.0	500
HPL-40	40.0	

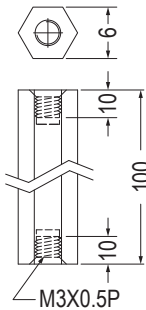
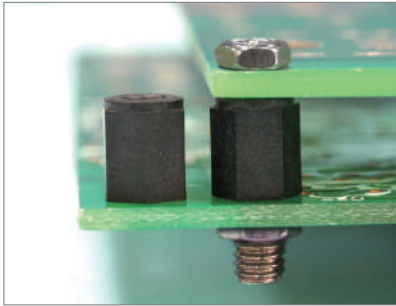

Part No.	Package
HPL-100	500

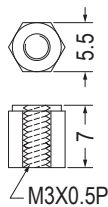

Part No.	Package
HPR3-7	1000

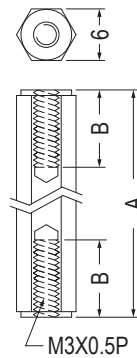

Part No.	A	B	Package
HPR-20	20.0	8.0	1000
HPR3-30	30.0	10.0	

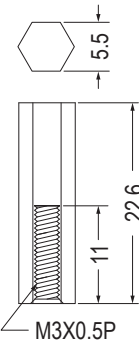

Part No.	Package
HPA3-22.6	1000

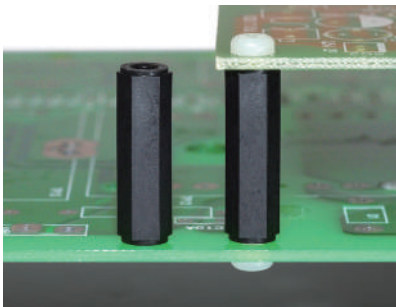

- Material: Nylon 6 (UL)+GF
- Flame Class: 94HB
- Color: Black

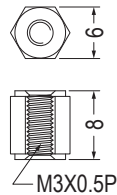

Part No.	Package
HPR-8	1000

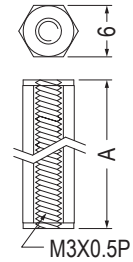

Part No.	A	Package
★HPR3-11	11.0	1000
HPR3-22	22.0	

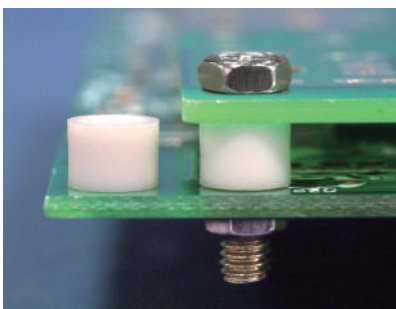

- Material: Nylon 66 (UL)
- Flame Class: 94V-2/94V-0
- Color: Natural/Black
- Unit: mm

用途：做為PC板與機板間之固定。

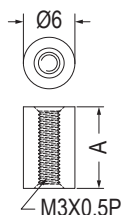

Part No.	A	Package
HPP3-9	9.0	1000
HPP3-9.5	9.5	

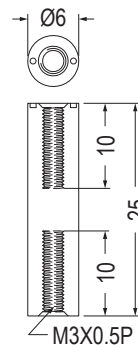

Part No.	Package
HPP3-25	1000

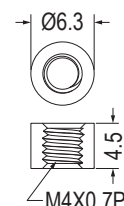

Part No.	Package
HPP4-4.5	1000

塑膠銅柱 STANDOFF

用途：做為PC板與機板間之固定，六角型不滑動。

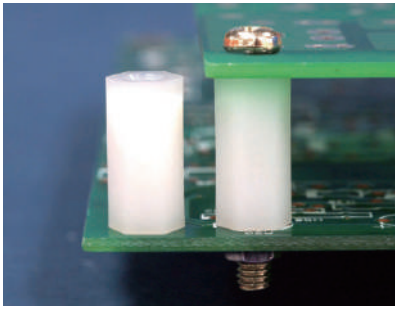

- Material: Nylon 66 (UL)
- Flame Class: 94V-2/94V-0
- Color: Natural/Black
- Unit: mm

NEW

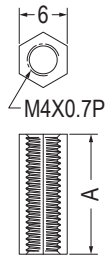

Part No.	A	Package
HPS4-6	6.0	1000
HPS4-8	8.0	
HPS4-10	10.0	
HPS4-12	12.0	
HPS4-15	15.0	
HPS4-18	18.0	
HPS4-20	20.0	

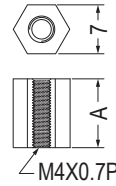

Part No.	A	Package
HP4-6	6.0	1000
HP4-7	7.0	
HP4-8	8.0	
HP4-9	9.0	
HP4-10	10.0	
HP4-11	11.0	
HP4-12	12.0	
HP4-12.7	12.7	

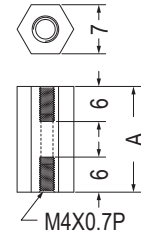

Part No.	A	Package
HP4-14	14.0	1000
HP4-16	16.0	
HP4-20	20.0	
HP4-25	25.0	
HP4-26	26.0	
HP4-30	30.0	
HP4-35	35.0	
HP4-40	40.0	
HP4-45S	45.0	
HP4-45	45.5	

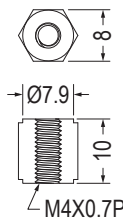
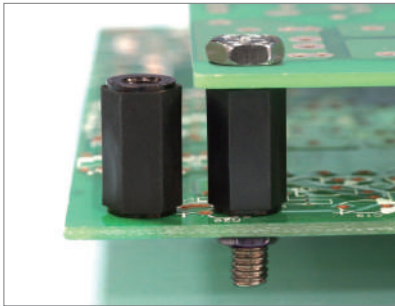

Part No.	Package
HPR4-10	1000

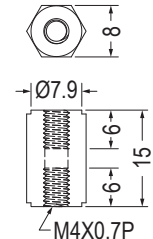

Part No.	Package
HPR4-15	1000

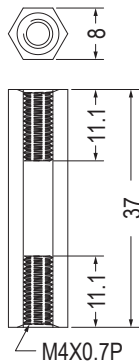

Part No.	Package
HPL4-37	1000

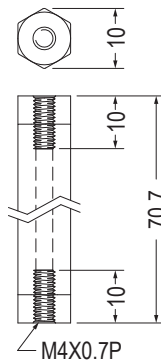

Part No.	Package
HPR4-70L	500

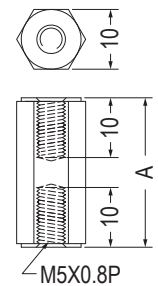

Part No.	A	Package
HPR5-25	25.0	1000
HPR5-45	45.0	500

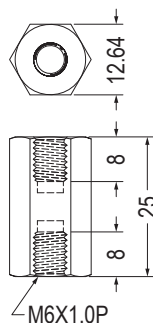
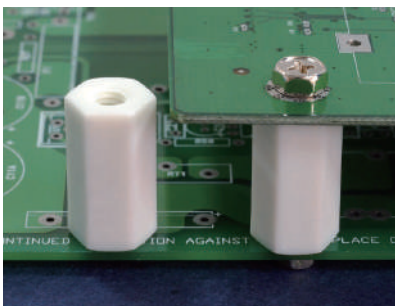

Part No.	Package
HP6-25	500

塑膠銅柱 STANDOFF

用途：做為牙管的延伸與對接。



- Material: PC+ABS (UL)
- Flame Class: 94V-0
- Color: Black
- Unit: mm

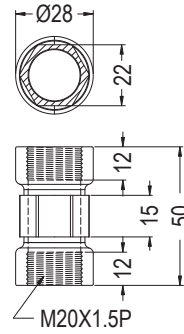

Part No.	Package
HP2050	1000



- Material: Nylon 66 (UL)
- Flame Class: 94V-2/94V-0
- Color: Natural/Black
- Unit: mm

用途：做為斷路器保護，避免誤觸。

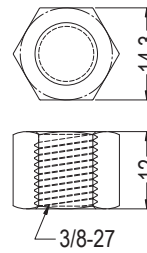

Part No.	Package
M-3/8-27	1000

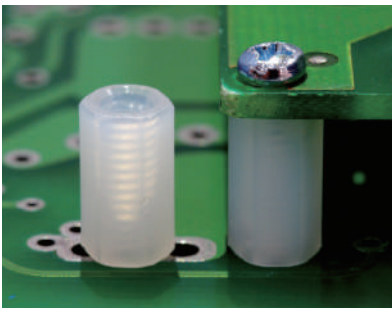

- Material: Nylon 66 (UL)
- Flame Class: 94V-2/94V-0
- Color: Natural/Black
- Unit: mm

用途：做為PC板與機板間之固定，六角型不滑動。

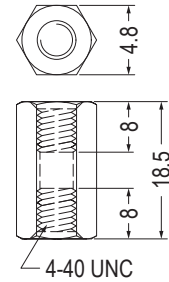
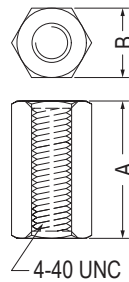

Part No.	A	B	Package
HP440-7.9S	7.9	4.75	1000
HP440-9.5	9.5	4.8	
HP440-15.9S	15.88	4.75	

Part No.	Package
HP440-18	1000

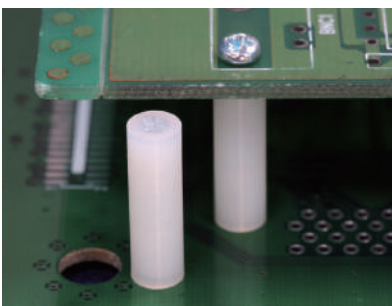

- Material: Nylon 66 (UL)
- Flame Class: 94V-2/94V-0
- Color: Natural/Black
- Unit: mm

用途：做為PC板與機板間之固定。

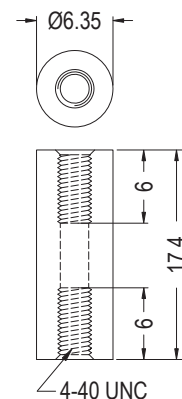
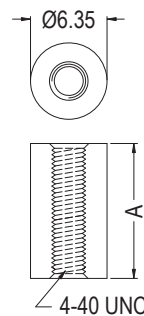
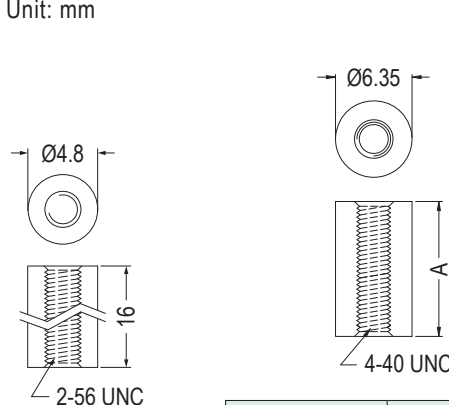

Part No.	Package
HP256-16	1000

Part No.	A	Package
HPP440-6.35	6.35	1000
HPP440-11.2	11.2	

Part No.	Package
HPP440-17.4	1000

塑膠銅柱 STANDOFF

用途：做為PC板與機板間之固定，六角型不滑動。

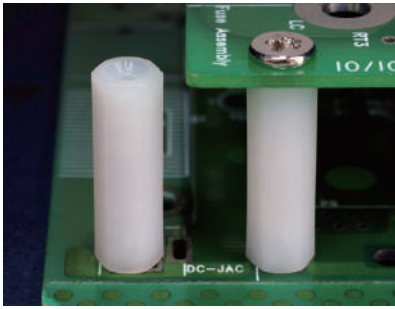

- Material: Nylon 66 (UL)
- Flame Class: 94V-2/94V-0
- Color: Natural/Black
- Unit: mm

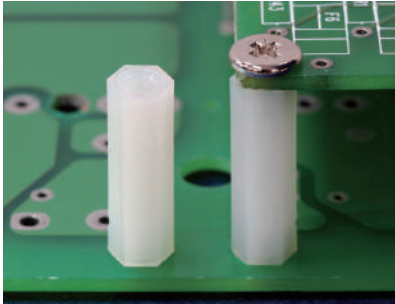
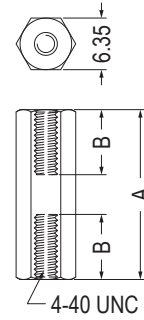
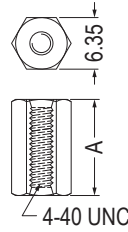

Part No.	A	Package
HP44L-6.35	6.35	1000
HP44L-8	8.0	
HP44L-9.5	9.5	
HP44L-12.7	12.7	
HP44L-15.9	15.9	
HP44L-19.1	19.1	

Part No.	A	B	Package
HP44L-22	22.2	9.0	1000
HP44L-23.8	23.8	6.4	
HP44L-25.4	25.4	9.0	
HP44L-28.6	28.6	6.4	

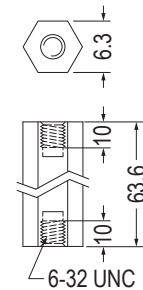
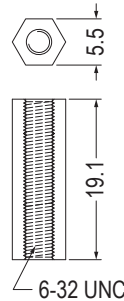
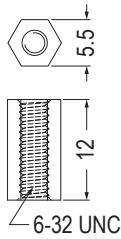

Part No.	Package
HPS632-12	1000

Part No.	Package
HPS632-19.1	1000

Part No.	Package
HP632-64	250

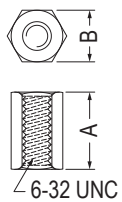

Part No.	A	B	Package
HP632-6.4	6.4	6.35	1000
HP632-9.5	9.5	6.35	
HP632-12.7	12.7	6.35	
HP632-15.9	15.9	6.35	
HP632-19.1	19.1	6.35	
HP632-22.2	22.2	6.35	
HP632-25.4	25.4	6.4	

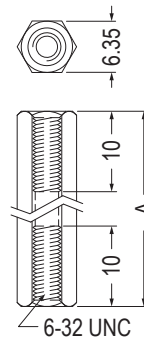

Part No.	A	Package
HP632-28.5	28.5	1000
HP632-31.8	31.8	
HP632-38.1	38.1	

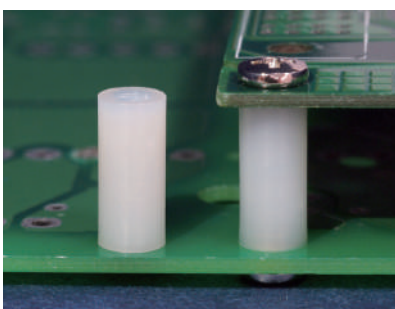

- Material: Nylon 66 (UL)
- Flame Class: 94V-2/94V-0
- Color: Natural/Black
- Unit: mm

用途：做為PC板與機板間之固定。

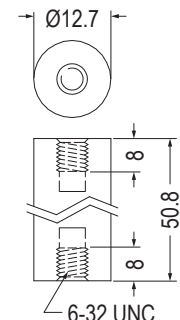
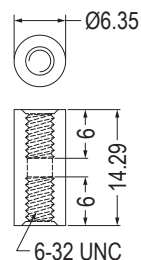

Part No.	Package
HPP632-14	1000

Part No.	Package
HPP632-51	200

塑膠銅柱 STANDOFF

用途：做為PC板與機板間之固定。

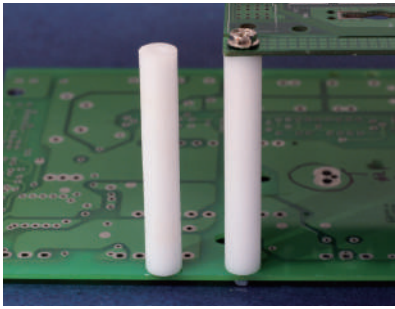

- Material: POM (UL)
- Flame Class: 94HB
- Color: Natural
- Unit: mm

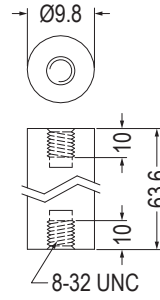

Part No.	Package
HPP10-64	250

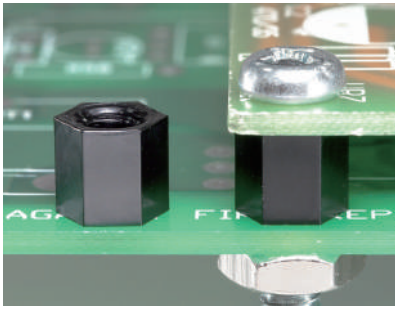

- Material: Nylon 66 (UL)
- Flame Class: 94V-2/94V-0
- Color: Natural/Black
- Unit: mm

用途：做為PC板與機板間之固定，六角型不滑動。

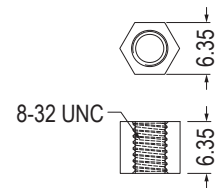
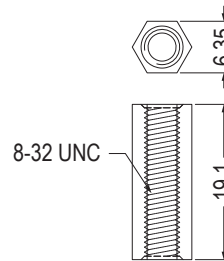
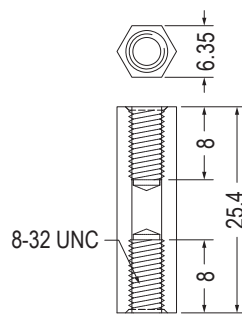

Part No.	Package
★HP832-25.4	1000

Part No.	Package
HP832-19.1	1000

Part No.	Package
HP832-6.35	1000

- Material: Nylon 46 (UL)
- Flame Class: 94V-2
- Color: Black

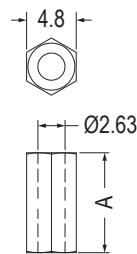
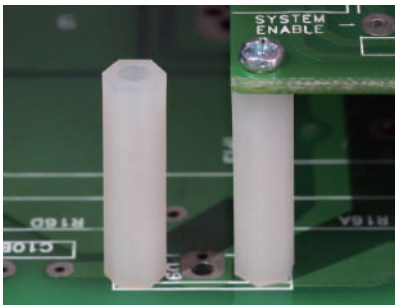

無攻牙

CLEAR WITHOUT TAPPING

Part No.	A	Package
HP48-20	20.0	1000
HP48-32	32.0	

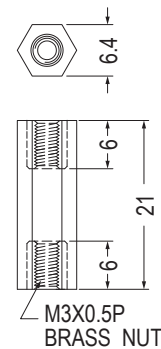
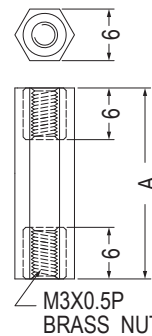
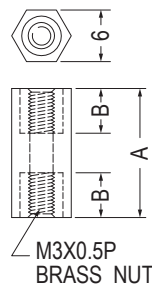
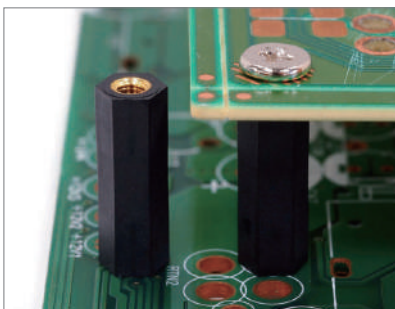

Part No.	A	B	Package
HPC-11.9	11.9	4.0	1000
HPC-15	15.0	4.5	

Part No.	A	Package
HPC-19	19.0	1000
HPC-30	30.0	
HPC-45	45.0	

Part No.	Package
HPC-21	1000

塑膠銅柱 STANDOFF

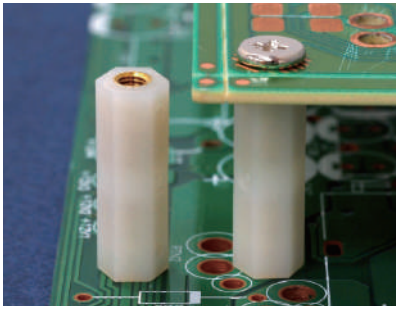

- Material: Nylon 66 (UL)
- Flame Class: 94V-2/94V-0
- Color: Natural/Black
- Unit: mm

用途：做為PC板與機板間之固定，六角型不滑動。

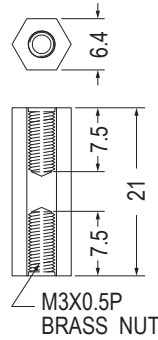

Part No.	Package
HPCA-21	1000

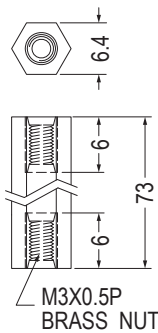

Part No.	Package
HPC-73	1000

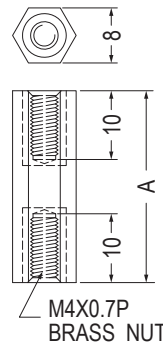

Part No.	A	Package
HPC4-30	30.0	250
HPC4-35	35.0	
HPC4-40	40.0	

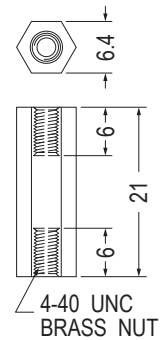

Part No.	Package
HPC44-21	1000

塑膠螺柱 THREADED SPACER

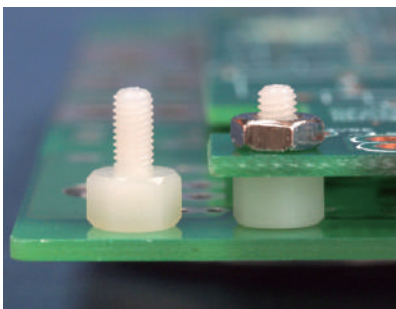

- Material: Nylon 66 (UL)
- Flame Class: 94V-2/94V-0
- Color: Natural/Black
- Unit: mm

用途：做為於零件之墊高。

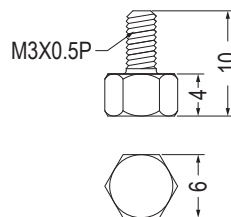

Part No.	Package
TPA-4	1000

塑膠銅柱 STANDOFF

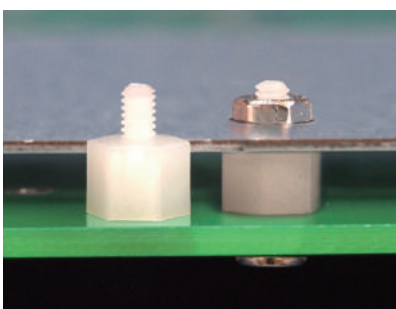

- Material: Nylon 66 (UL)
- Flame Class: 94V-2/94V-0
- Color: Natural/Black
- Unit: mm

用途：做為PC板與機板間之固定，一端配合螺絲，另一端配合螺帽使用。

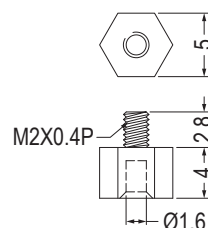

Part No.	Package
TP2L-4	1000

塑膠銅柱 STANDOFF

用途：做為PC板與機板間之固定，一端配合螺絲，另一端配合螺帽使用。

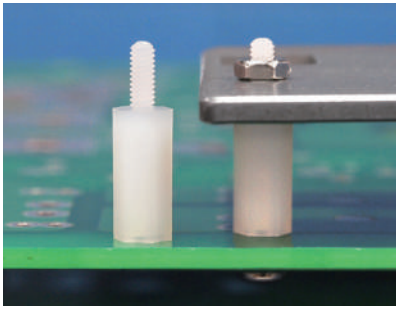

- Material: Nylon 66 (UL)
- Flame Class: 94V-2/94V-0
- Color: Natural/Black
- Unit: mm

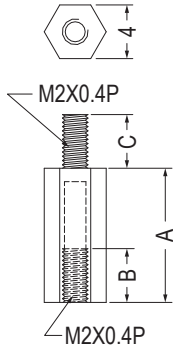

Part No.	A	B	C	Package
TP2-5S	5.0	3.0	4.0	1000
TP2-6.5S	6.5	4.0	4.0	
TP2-8S	8.0	4.0	4.0	
TP2-10S	10.0	4.0	4.0	
TP2-15S	15.0	4.0	4.0	
TP2-4	4.0	2.5	5.0	
TP2-5	5.0	3.0	5.0	
TP2-5.5	5.5	3.0	5.0	
TP2-6	6.0	4.0	5.0	
TP2-6.5	6.5	4.0	5.0	
TP2-7	7.0	4.0	5.0	
TP2-8	8.0	5.0	5.0	
TP2-9	9.0	5.0	5.0	
TP2-10	10.0	5.0	5.0	
TP2-11	11.0	5.0	5.0	
TP2-12	12.0	5.0	5.0	

Part No.	A	B	C	Package
TP2-13	13.0	5.0	5.0	1000
TP2-14	14.0	5.0	5.0	
TP2-15	15.0	5.0	5.0	
TP2-16	16.0	5.0	5.0	
TP2-17	17.0	5.0	5.0	
TP2-18	18.0	5.0	5.0	
TP2-19	19.0	5.0	5.0	
TP2-20	20.0	5.0	5.0	
TP2-21	21.0	5.0	5.0	
TP2-22	22.0	5.0	5.0	
TP2-23	23.0	5.0	5.0	
TP2-24	24.0	5.0	5.0	
TP2-25	25.0	5.0	5.0	
TP2-26	26.0	5.0	5.0	
TP2-27	27.0	5.0	5.0	
TP2-28	28.0	5.0	5.0	

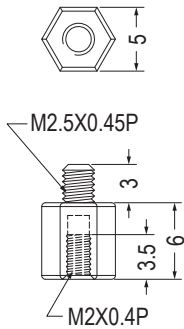

Part No.	Package
TP2.5-2-6	1000

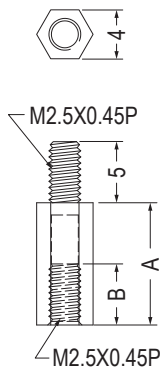

Part No.	A	B	Package
TP2.5-5	5.0	3.0	1000
TP2.5-6	6.0	4.0	
TP2.5-7	7.0	5.0	
TP2.5-8	8.0	5.0	
TP2.5-9	9.0	5.0	
TP2.5-10	10.0	5.0	
TP2.5-11	11.0	5.0	
TP2.5-12	12.0	5.0	
TP2.5-13	13.0	5.0	
TP2.5-14	14.0	5.0	
TP2.5-15	15.0	5.0	
TP2.5-16	16.0	5.0	

Part No.	A	B	Package
TP2.5-17	17.0	5.0	1000
TP2.5-18	18.0	5.0	
TP2.5-19	19.0	5.0	
TP2.5-20	20.0	5.0	
TP2.5-21	21.0	5.0	
TP2.5-22	22.0	5.0	
TP2.5-23	23.0	5.0	
TP2.5-24	24.0	5.0	
TP2.5-24.5	24.5	5.0	
TP2.5-25	25.0	5.0	
TP2.5-26	26.0	5.0	
TP2.5-27	27.0	5.0	
TP2.5-28	28.0	5.0	

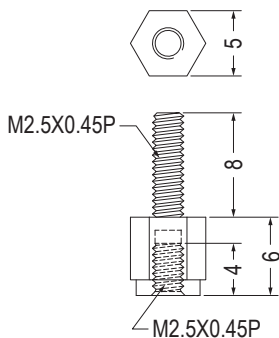

Part No.	Package
TP2.5-6L	1000

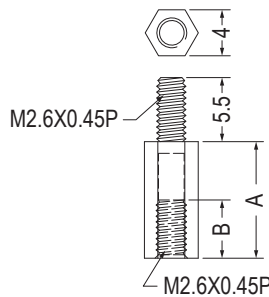

Part No.	A	B	Package
TP2.6-4	4.0	2.0	1000
TP2.6-5	5.0	3.0	
TP2.6-6	6.0	4.0	
TP2.6-7	7.0	5.0	
TP2.6-8	8.0	5.5	
TP2.6-9	9.0	5.5	
TP2.6-10	10.0	5.5	
TP2.6-11	11.0	5.5	
TP2.6-12	12.0	5.5	
TP2.6-12.7	12.7	5.5	

Part No.	A	B	Package
TP2.6-13	13.0	5.5	1000
TP2.6-14	14.0	5.5	
TP2.6-15	15.0	5.5	
TP2.6-16	16.0	5.5	
TP2.6-17	17.0	5.5	
TP2.6-18	18.0	5.5	
TP2.6-19	19.0	5.5	
TP2.6-20	20.0	5.5	
TP2.6-21	21.0	5.5	
TP2.6-22	22.0	5.5	
TP2.6-23	23.0	5.5	
TP2.6-24	24.0	5.5	
TP2.6-25	25.0	5.5	
TP2.6-26	26.0	5.5	
TP2.6-27	27.0	5.5	
TP2.6-28	28.0	5.5	

塑膠銅柱 STANDOFF

用途：做為PC板與機板間之固定，一端配合螺絲，另一端配合螺帽使用。

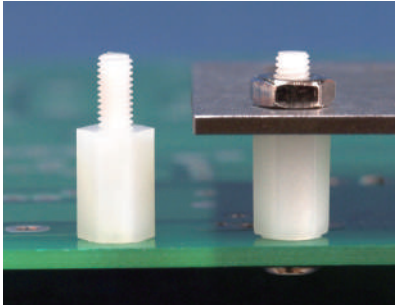
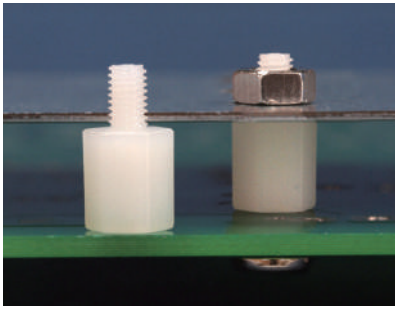

- Material: Nylon 66 (UL)
- Flame Class: 94V-2/94V-0
- Color: Natural/Black
- Unit: mm

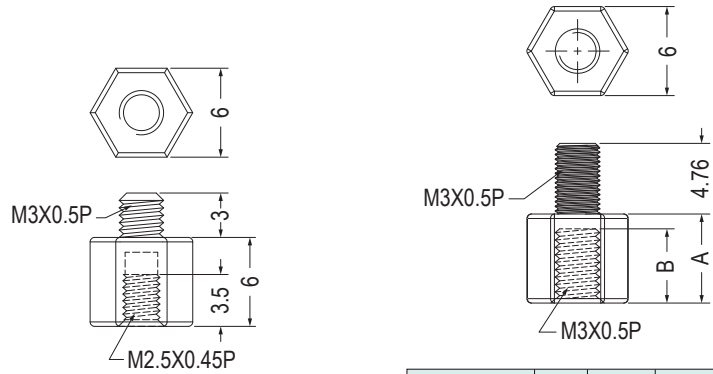

Part No.	Package
TP3-2.5-6	1000

Part No.	A	B	Package
★TP3-6	6.0	5.0	1000
TP3-7.5	7.5	6.25	

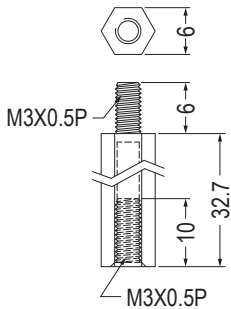

Part No.	Package
TP-32.7L	1000

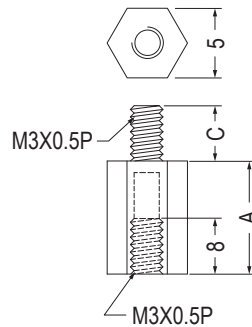

Part No.	A	C	Package
TPS-10S	10.0	5.0	1000
TPS-10	10.0	8.0	
TPS-12	12.0	8.0	
TPS-13	13.0	8.0	
TPS-15	15.0	8.0	
TPS-18	18.0	8.0	
TPS-20	20.0	8.0	
TPS-25	25.0	8.0	

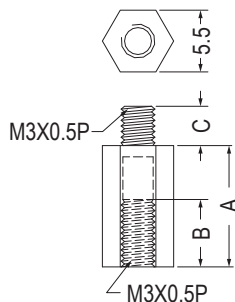

Part No.	A	B	C	Package
TP-5S	5.0	4.0	3.5	1000
TP-5SM	5.0	4.0	5.0	
TP-6S	6.0	4.0	5.0	
TP-7-4	7.0	5.0	4.0	
TP-9-4	9.0	6.0	4.0	
TP-10.8	10.8	6.0	3.5	
TP-11.2	11.2	6.0	3.5	
TP-16S	16.0	6.0	4.0	
TP-18S	18.0	6.0	5.0	
TP-20S	20.0	8.0	5.0	

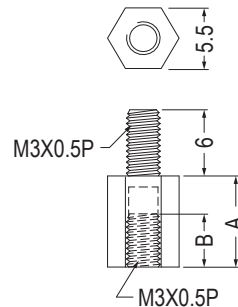

Part No.	A	B	Package
TP-4	4.0	3.0	1000
TP-5	5.0	3.0	
TP-6	6.0	4.0	
TP-7	7.0	5.0	
TP-7.5	7.5	5.0	
TP-8	8.0	6.0	
TP-8.5	8.5	6.0	
TP-9	9.0	6.0	
TP-9.5	9.5	6.0	
TP-10	10.0	6.0	
TP-10.5	10.5	6.0	
TP-10.8L	10.8	6.0	
TP-11	11.0	6.0	
TP-12A	12.0	6.0	
TP-12	12.7	6.0	
TP-13	13.0	6.0	

Part No.	A	B	Package
TP-14	14.0	6.0	1000
TP-15	15.0	6.0	
TP-15.5	15.5	6.0	
TP-16	16.0	6.0	
TP-16.5	16.5	6.0	
TP-17	17.0	6.0	
TP-18	18.0	6.0	
TP-18.5	18.5	6.0	
TP-19	19.0	6.0	
TP-20	20.0	8.0	
TP-21	21.0	6.0	
TP-22	22.0	6.0	
TP-24.5	24.5	6.0	
TP-25	25.0	6.0	
TP-27	27.0	6.0	
TP-28	28.0	6.0	
TP-28.5	28.5	6.0	
TP-30	30.0	8.0	
TP-33	33.0	6.0	
TP-34.5	34.5	6.0	
TP-35	35.0	6.0	
TP-36	36.0	6.0	
TP-37	37.0	6.0	
TP-40	40.0	6.0	
TP-45	45.0	6.0	
TP-53.5	53.5	6.0	
TP-55.5	55.5	8.0	

塑膠銅柱 STANDOFF

用途：做為PC板與機板間之固定，一端配合螺絲，另一端配合螺帽使用。

1

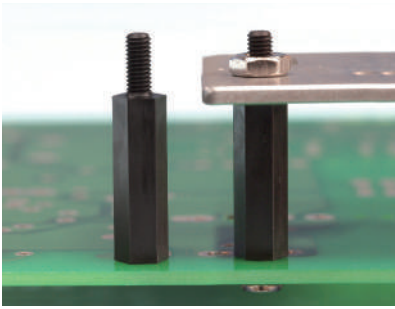

- Material: POM
- Color: Black
- Unit: mm

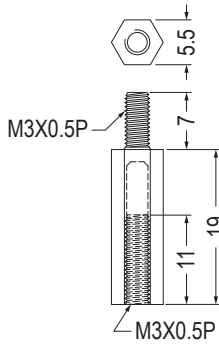

Part No.	Package
TPD-19	1000

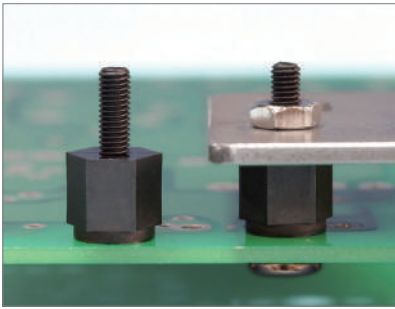

- Material: Nylon 66 (UL)
- Flame Class: 94V-2/94V-0
- Color: Natural/Black
- Unit: mm

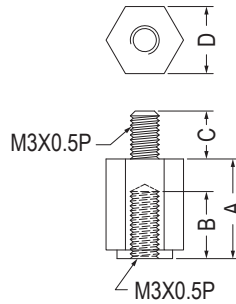

Part No.	A	B	C	D	Package
TP3-6L	6.0	4.0	8.0	6.0	1000
★TP3-8L	8.0	6.0	8.0	6.0	
TP3-10L	10.0	8.0	8.0	6.0	
TP3-10.4	10.4	7.0	5.0	7.0	
TP3-11L	11.0	9.0	8.0	6.0	
TP3-12L	12.0	10.0	8.0	6.0	
★TP3-15L	15.0	10.0	8.0	6.0	
TP3-18L	18.0	10.0	8.0	6.0	
★TP3-50L	50.0	10.0	8.0	6.0	500

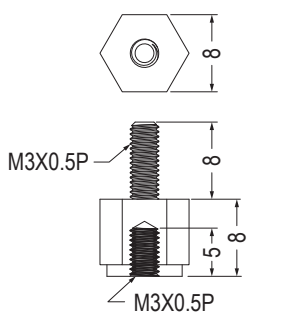
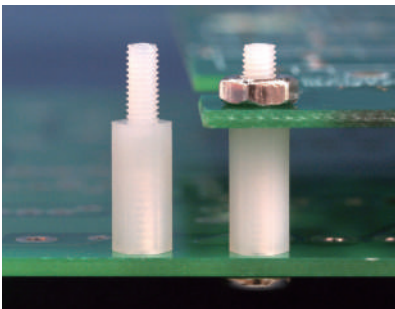

Part No.	Package
TP-8L	1000

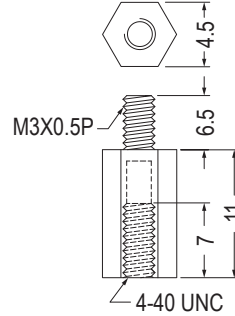

Part No.	Package
TPS44-11	1000

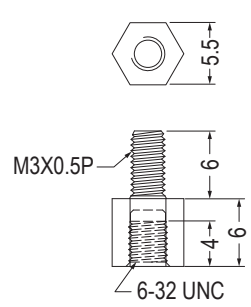

Part No.	Package
TPS632-6	1000

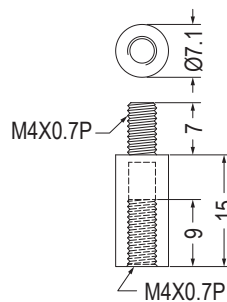
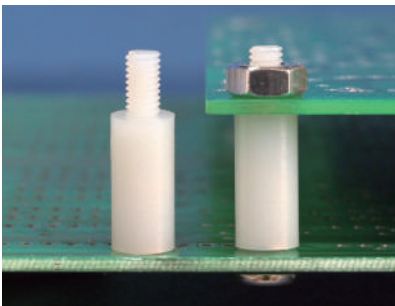

Part No.	Package
TPR4-15	1000

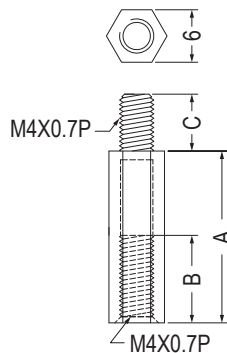
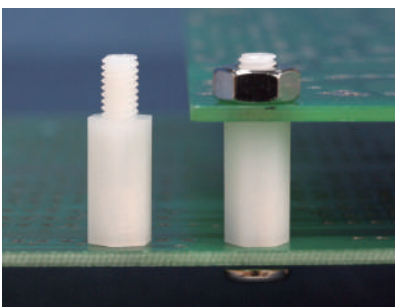

Part No.	A	B	C	Package
TPS4-10L	10.0	8.0	9.5	1000
TPS4-12L	12.0	8.0	9.5	
TPS4-13	13.0	6.0	6.5	
TPS4-15L	15.0	12.0	9.5	
★TPS4-20L	20.0	12.0	9.5	
TPS4-25L	25.0	12.0	9.5	
TPS4-30	30.0	10.0	6.5	
TPS4-55	55.0	10.0	6.5	

塑膠銅柱 STANDOFF

用途：做為PC板與機板間之固定，一端配合螺絲，另一端配合螺帽使用。

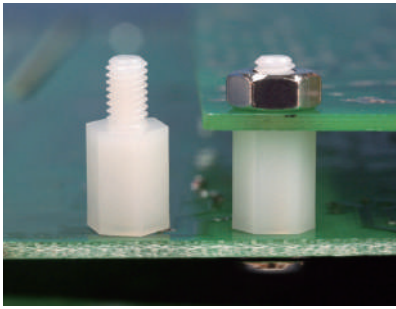

- Material: Nylon 66 (UL)
- Flame Class: 94V-2/94V-0
- Color: Natural/Black
- Unit: mm

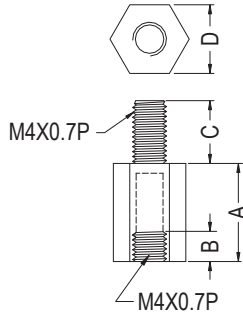
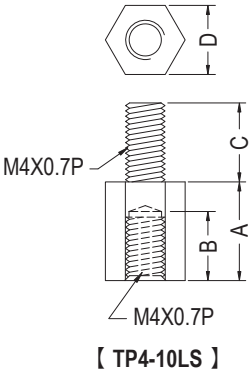

Part No.	A	B	C	D	Package
TP4-6	6.0	4.0	6.5	7.0	1000
TP4-8	8.0	6.0	6.5	7.0	
TP4-10	10.0	6.0	6.5	7.0	
TP4-10LS	10.0	7.0	8.0	7.0	
TP4-10L	10.0	7.0	8.0	8.0	

Part No.	A	B	C	D	Package
TP4-12	12.0	6.0	6.5	7.0	1000
TP4-13	13.0	6.0	6.5	7.0	
TP4-14	14.0	6.0	6.5	7.0	
TP4-15	15.0	6.0	6.5	7.0	
TP4-16	16.0	7.0	6.5	7.0	
TP4-17	17.0	7.0	6.5	7.0	
TP4-19	19.0	7.0	6.5	7.0	
TP4-20	20.0	8.0	6.5	7.0	
TP4-25	25.0	8.0	6.5	7.0	
TP4-27	27.0	8.0	6.5	7.0	
TP4-30	30.0	8.0	6.5	7.0	
TP4-34	34.0	8.0	6.5	7.0	
TP4-35	35.0	8.0	6.5	7.0	
TP4-37	37.0	8.0	6.5	7.0	
TP4-40	40.0	8.0	6.5	7.0	
TP4-45	45.5	8.0	6.5	7.0	
TP4-57	57.0	8.0	6.5	7.0	

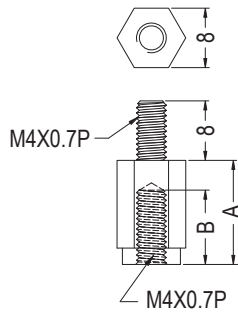
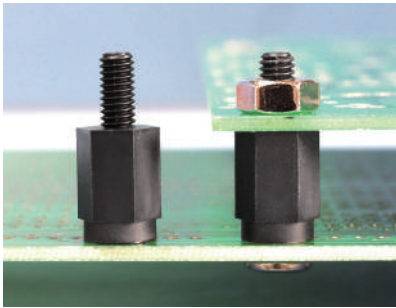

Part No.	A	B	Package
TP4-8L	8.0	6.0	1000
TP4-10R	10.0	8.0	
TP4-11R	11.0	9.0	
TP4-12L	12.0	10.0	
TP4-14L	14.0	10.0	
TP4-20L	20.0	10.0	
TP4-32L	32.0	10.0	500
TP4-35L	35.0	10.0	

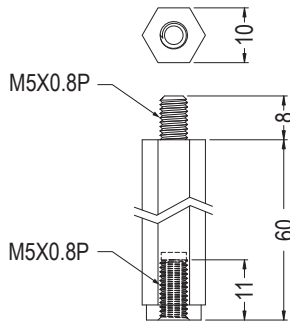
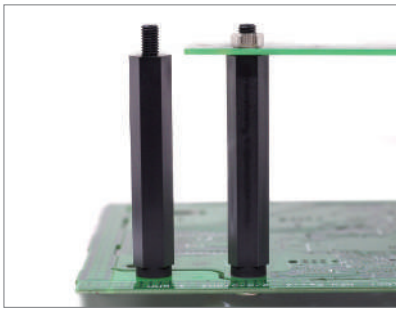

Part No.	Package
TP5-60	250

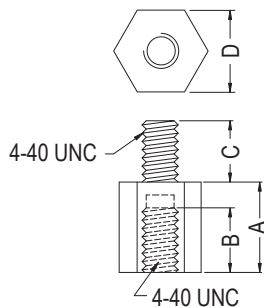
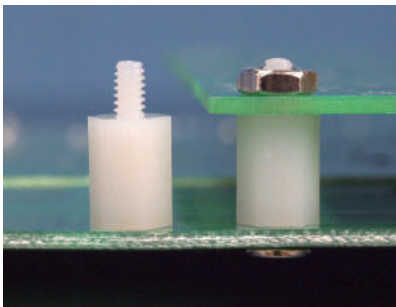

Part No.	A	B	C	D	Package
TP440-6.4	6.4	4.0	4.8	6.4	1000
TP440-6.4-4.8	6.4	4.8	4.8	6.4	
TP440-7	7.0	4.0	4.8	6.4	
TP440-8S	8.0	6.35	4.8	4.8	
TP440-9.5	9.5	6.0	4.8	6.4	
TP440-12.7	12.7	6.0	4.8	6.4	
TP440-15.2	15.24	4.75	4.75	6.35	
TP440-15.9	15.9	6.0	4.8	6.4	
TP440-19.1	19.1	6.0	4.8	6.4	
TP440-19.1S	19.05	6.35	4.75	4.75	
TP440-22.2	22.2	4.75	4.75	6.35	
TP440-25.4	25.4	4.75	4.75	6.35	
TP440-28.7	28.7	6.0	4.8	6.4	

塑膠銅柱 STANDOFF

用途：做為PC板與機板間之固定，一端配合螺絲，另一端配合螺帽使用。

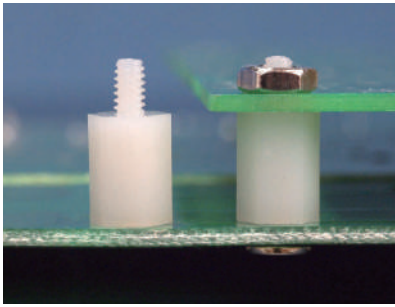

- Material: Nylon 66 (UL)
- Flame Class: 94V-2/94V-0
- Color: Natural/Black
- Unit: mm

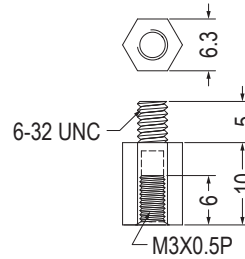

Part No.	Package
TP632-M310	1000

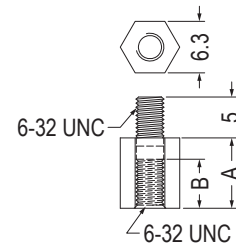
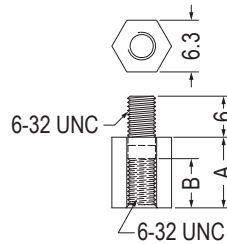
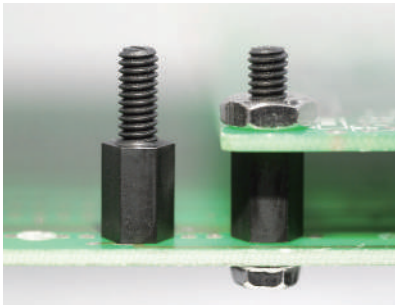

Part No.	A	B	Package
TP632-5	5.0	3.0	1000
TP632-5.5	5.5	3.5	
TP632-6	6.0	4.0	
TP632-6.3	6.3	4.0	
TP632-8	8.0	6.0	
TP632-9	9.0	6.0	
TP632-10	10.0	6.0	
TP632-11	11.0	6.0	
TP632-12	12.0	6.0	
TP632-12.7	12.7	6.0	
TP632-15.9	15.9	6.0	
TP632-19.1	19.1	6.0	
TP632-25.4	25.4	6.0	
TP632-28.6	28.6	9.5	
TP632-31.8	31.8	6.0	
TP632-51	51.0	6.0	

Part No.	A	B	Package
TP632-5S	5.0	3.0	1000
TP632-5.5S	5.5	3.5	
TP632-6S	6.0	4.0	
TP632-6.3S	6.3	4.0	
TP632-8S	8.0	6.0	
TP632-9S	9.0	6.0	
TP632-10S	10.0	6.0	
TP632-11S	11.0	6.0	
TP632-12S	12.0	6.0	
TP632-12.7S	12.7	6.0	
TP632-15.9S	15.9	6.0	
TP632-19.1S	19.1	6.0	
TP632-25.4S	25.4	6.0	
TP632-31.8S	31.8	6.0	

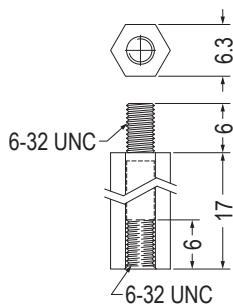

- Material: Nylon 46 (UL)
- Flame Class: 94V-2
- Color: Black

Part No.	Package
★TP632-17	1000

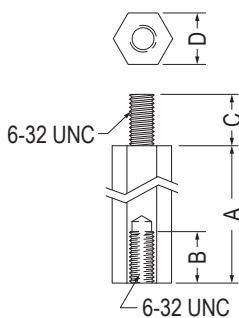

Part No.	A	B	C	D	Package
TP632-9.5L	9.5	6.4	6.4	6.4	1000
TP632-17.5L	17.5	6.4	6.4	6.4	
TP632-31.8L	31.8	6.35	6.35	6.35	
TP632-34.9L	34.9	6.35	6.35	6.35	
TP632-38.1L	38.1	6.35	6.35	6.35	
TP632-41.3L	41.3	6.35	6.35	6.35	
TP632-44.5L	44.5	6.35	6.35	6.35	500
TP632-50.8L	50.8	6.35	6.35	6.35	

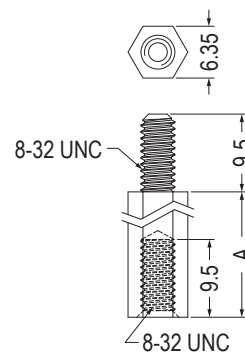

Part No.	A	Package
TP832-12.7	12.7	1000
TP832-19.1	19.1	
TP832-22.2	22.2	

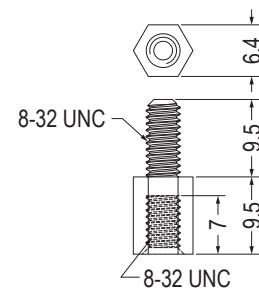

- Material: Nylon 46 (UL)
- Flame Class: 94V-2
- Color: Black

Part No.	Package
TP832-9.5	1000

塑膠銅柱 STANDOFF

用途：PC板與PC板間之固定，不佔空間。

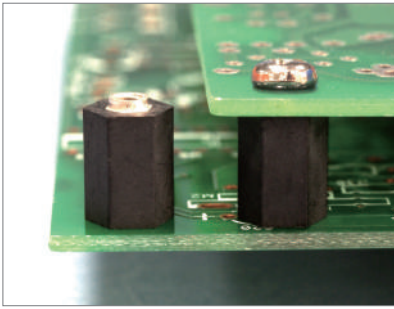

- Material: Nylon 66 (UL)
- Flame Class: 94V-2/94V-0
- Color: Natural/Black
- Unit: mm

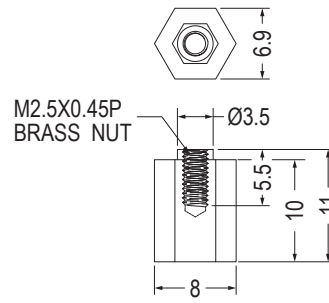

Part No.	Package
HPB2.5-10	1000

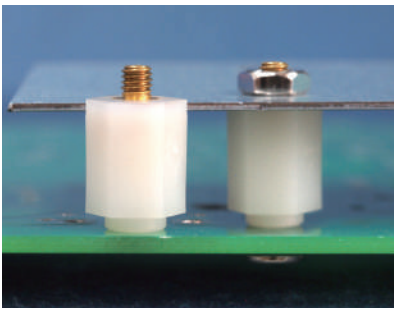

- Material: Nylon 66 (UL)
- Flame Class: 94V-2/94V-0
- Color: Natural/Black
- Unit: mm

用途：做為PC板與機板間之固定，一端配合螺絲，另一端配合螺帽使用。

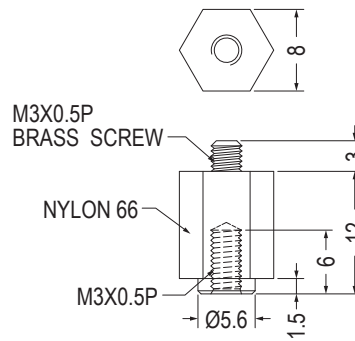

Part No.	Package
MTPE3-12	1000

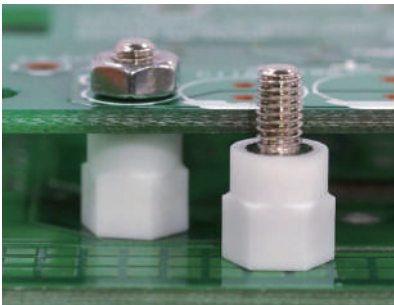

- Material: Nylon 6 (UL)
- Flame Class: 94V-0
- Color: Natural
- Unit: mm

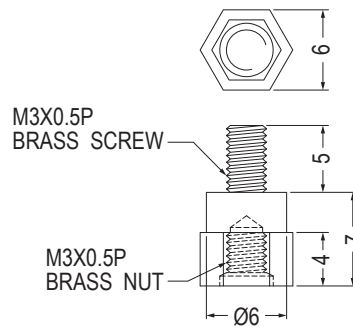

Part No.	Package
MTPF3-7	1000

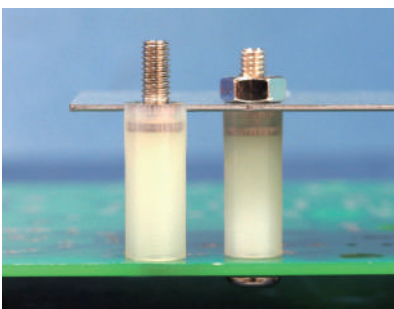

- Material: Nylon 66 (UL)
- Flame Class: 94V-2/94V-0
- Color: Natural/Black
- Unit: mm

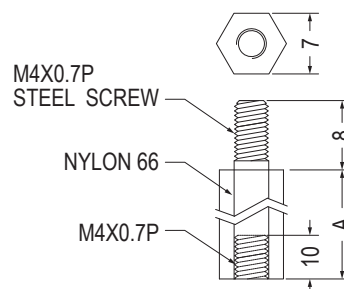

Part No.	A	Package
MTPC4-20	20.0	1000
MTPC4-57	57.0	

塑膠銅柱 STANDOFF

用途：PC板與PC板間之固定，不佔空間。

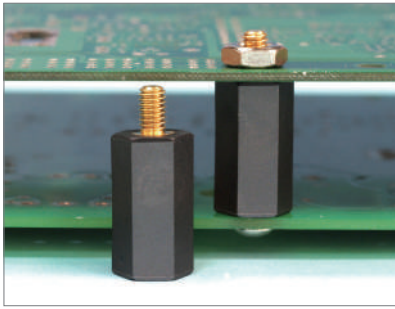

- Material: Nylon 66 (UL)
- Flame Class: 94V-2/94V-0
- Color: Natural/Black
- Unit: mm

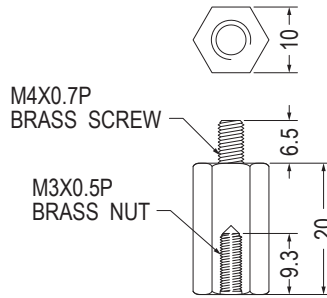

Part No.	Package
MTPA4-3-20	1000

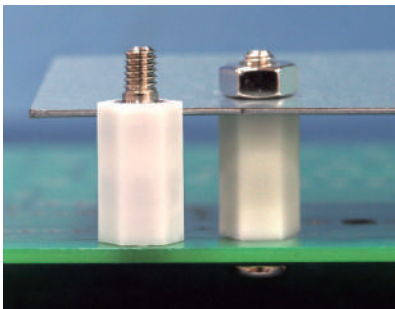

- Material: Nylon 66 (UL)
- Flame Class: 94V-2/94V-0
- Color: Natural/Black
- Unit: mm

用途：做為PC板與機板間之固定，一端配合螺絲，另一端配合螺帽使用。

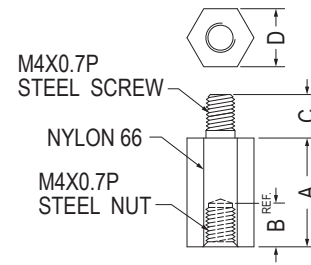
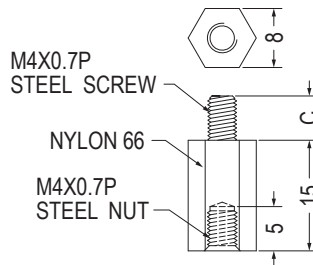

Part No.	C	Package
MTPA4-15-1	6.0	1000
MTPA4-15L	8.0	

Part No.	A	B	C	D	Package
MTPA4-15	15.0	5.0	6.0	8.0	1000
MTPA4-50L	50.0	6.0	8.0	9.0	200

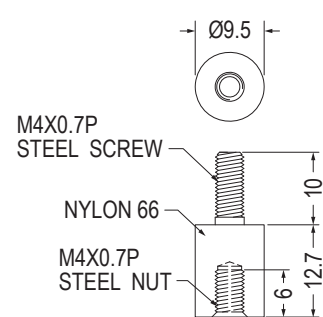
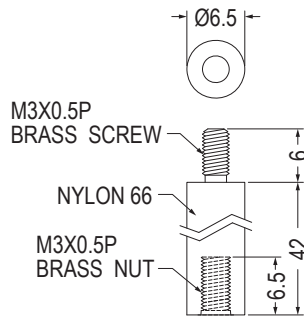
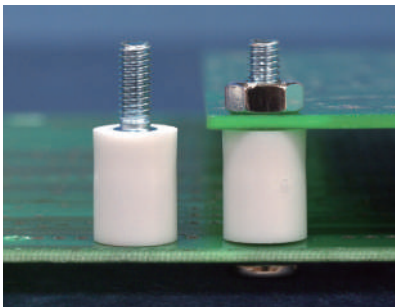

Part No.	Package
MTPG3-42	500

Part No.	Package
MTP4-12.7	1000

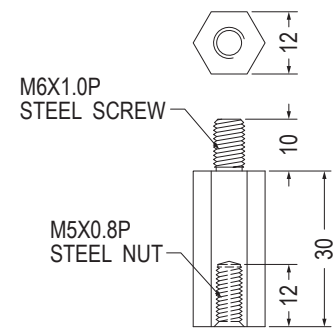
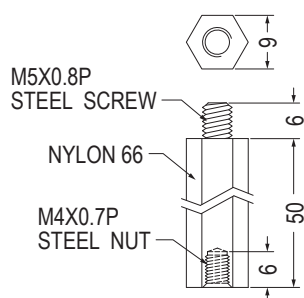
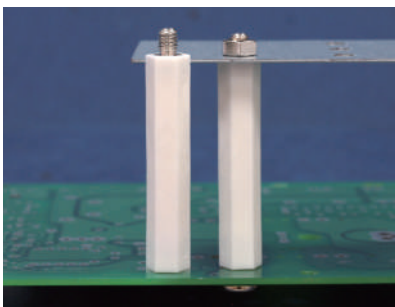

Part No.	Package
MTPA5-4-50	250

Part No.	Package
MTPA6-5-30	1000

塑膠銅柱 STANDOFF

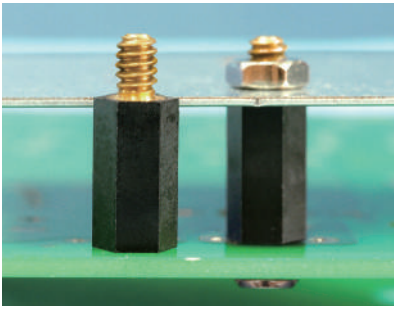

- Material: Nylon 66 (UL)
- Flame Class: 94V-2/94V-0
- Color: Natural/Black
- Unit: mm

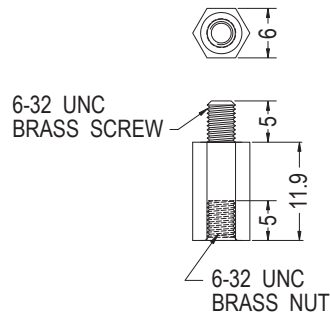

用途：做為PC板與機板間之固定，一端配合螺絲，另一端配合螺帽使用。

Part No.	Package
MTPD632-11.9	1000

1

銅柱 STANDOFF

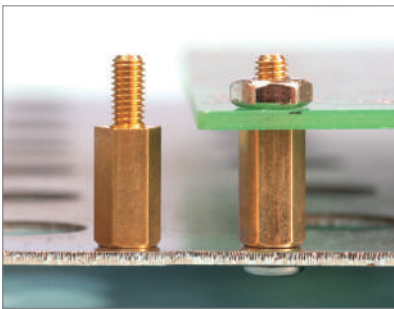

- Material: Brass
- Unit: mm

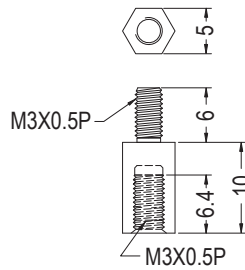

用途：做為PC板與機板間之固定，一端配合螺絲，另一端配合螺帽使用。

Part No.	Package
TP-10BA	1000

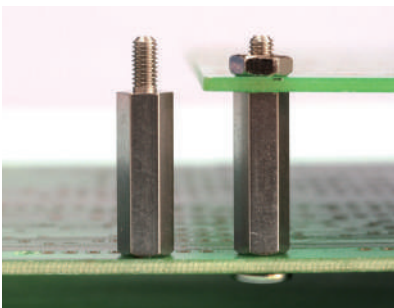

- Material: Steel/SUS
- Unit: mm

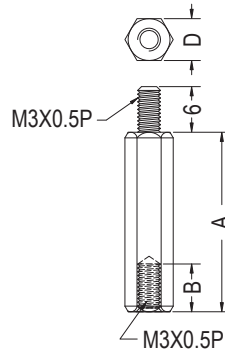

Part No.	A	B	D	Package
TP-18SUS	18.0	8.0	5.5	500
TP-25ST	25.0	6.0	5.0	
TP-30SUS	30.0	6.0	5.0	
TP-55SUS	54.9	8.0	5.5	

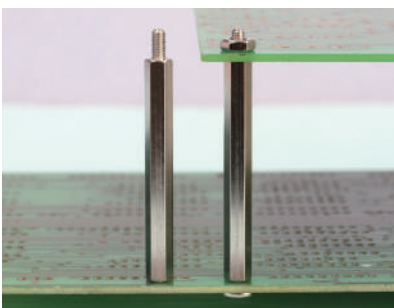

- Material: Steel
- Unit: mm

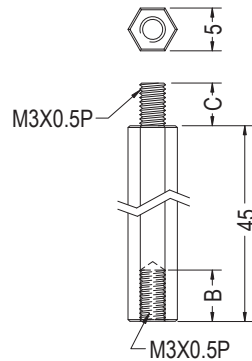

Part No.	B	C	Package
TP3-45ST	5.5	6.0	500
TP3-45LST	6.0	7.0	

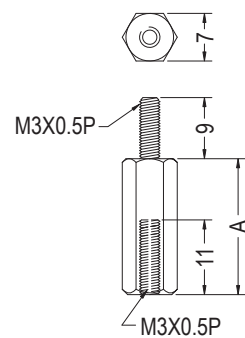

Part No.	A	Package
TPB3-20NI	20.0	500
TPB3-40NI	40.0	

銅柱 STANDOFF

用途：做為PC板與機板間之固定，一端配合螺絲，另一端配合螺帽使用。

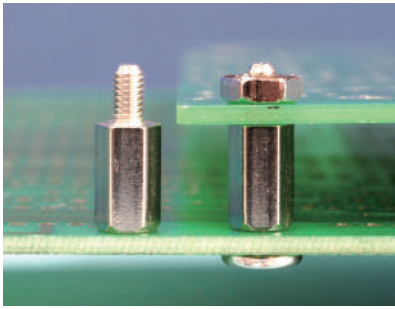

- Material: Steel
- Unit: mm

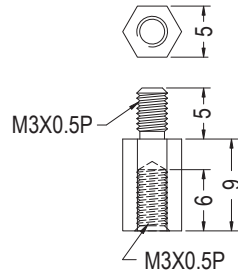

Part No.	Package
TP3-9ST	1000

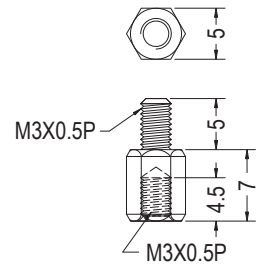

Part No.	Package
TPS3-7ST	1000

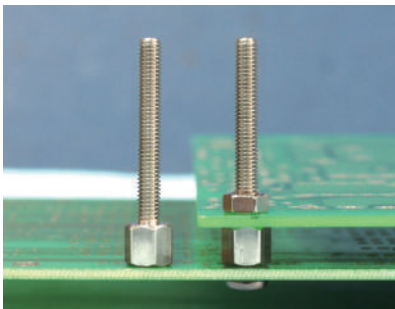

- Material: SUS
- Unit: mm

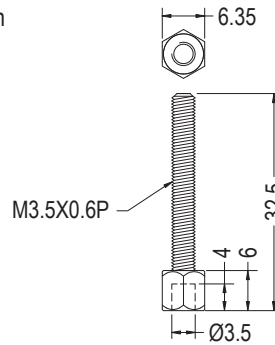

Part No.	Package
TP-6ST	500

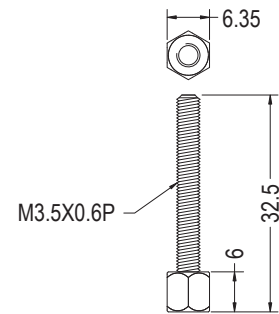

Part No.	Package
TP-6ST-1	500

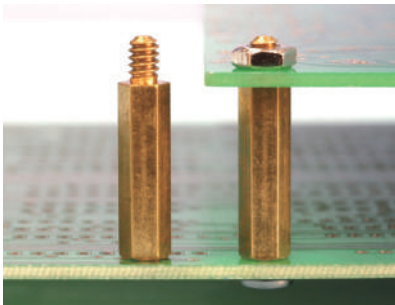

- Material: Brass
- Unit: mm

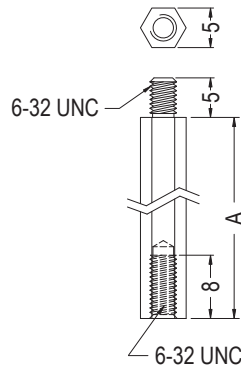

Part No.	A	Package
TP632-19.05BA	19.05	500
TP632-25.4BA	25.4	

塑膠銅柱 STANDOFF

用途：做為PC板與機板間之固定，兩端配合攻牙或螺母使用。

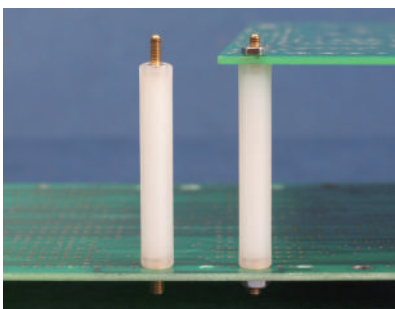

- Material: Nylon 66 (UL)
- Flame Class: 94V-2/94V-0
- Color: Natural/Black
- Unit: mm

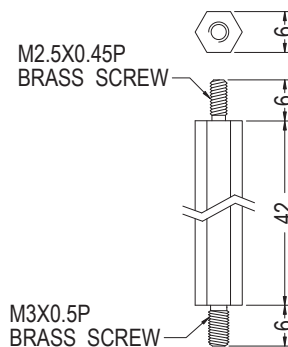

Part No.	Package
TPIM2.5-3-42	500

塑膠銅柱 STANDOFF

用途：做為PC板與機板間之固定，兩端配合攻牙或螺母使用。

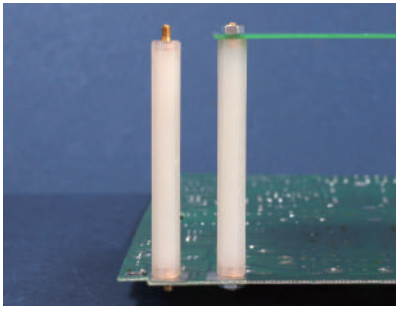

- Material: Nylon 6
- Color: Natural
- Unit: mm

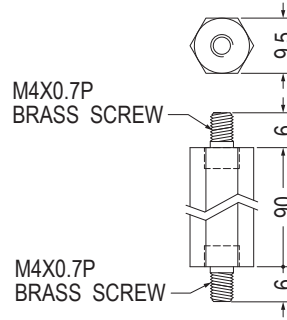

Part No.	Package
TPIM4-90	500

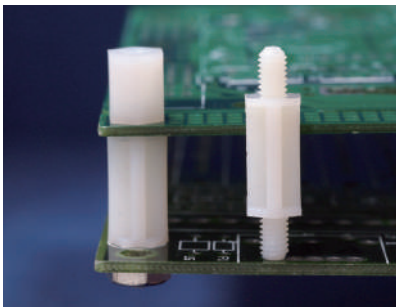

- Material: Nylon 66 (UL)
- Flame Class: 94V-2/94V-0
- Color: Natural/Black
- Unit: mm

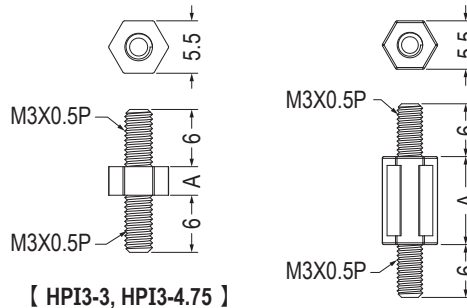

【 HPI3-3, HPI3-4.75 】

Part No.	A	Package
HPI3-3	3.0	1000
HPI3-4.75	4.75	
HPI3-5	5.0	
HPI3-5.5	5.5	
HPI3-10	10.0	
HPI3-15	15.0	

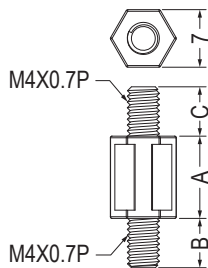

Part No.	A	B	C	Package
HPI4-5	5.0	6.0	6.0	1000
HPI4-10	10.0	6.0	6.0	
HPI4-15	15.0	6.0	6.0	
HPI4-17L	17.0	8.0	8.0	
HPI4-19	19.0	6.0	6.0	
★HPI4-25	25.0	6.0	6.0	

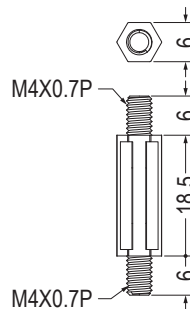

Part No.	Package
HPIB4-18.5	1000

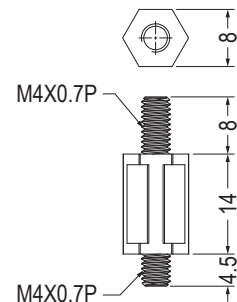

Part No.	Package
HPID4-14	1000

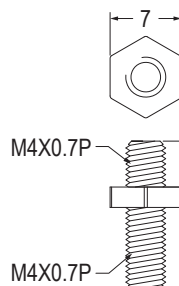
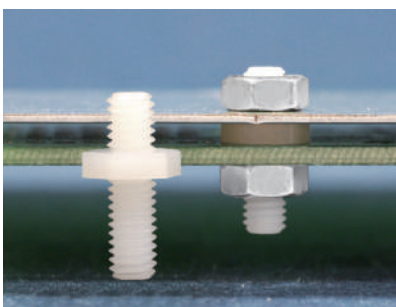

Part No.	Package
HPIA4-2	1000

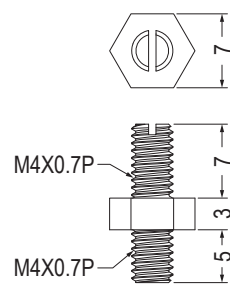

Part No.	Package
HPIE4-3	1000

PC板間隔柱 SPACER SUPPORT

用途：PC板端直接壓入固定，另一端可配合螺母或攻牙。

1

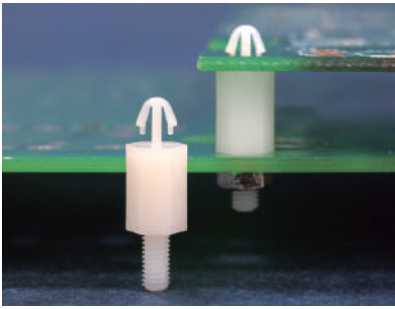

- Material: Nylon 66 (UL)
- Flame Class: 94V-2/94V-0
- Color: Natural/Black
- Unit: mm

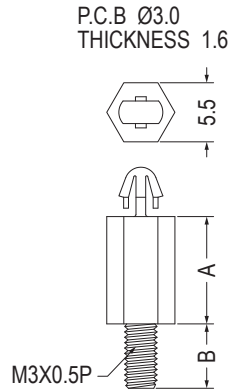

Part No.	A	B	Package
SCBA-3	3.0	6.3	1000
SCBA-3S	3.0	3.0	
SCBA-4	4.0	6.3	
SCBA-5	5.0	6.3	
★SCBA-5S	5.0	4.5	
SCBA-6	6.0	6.3	
SCBA-6S	6.0	4.5	
SCBA-7	7.0	6.3	
SCBA-8	8.0	6.3	
SCBA-9	9.0	6.3	
SCBA-10	10.0	6.3	
SCBA-11	11.0	6.3	
SCBA-12	12.0	6.3	
SCBA-13	13.0	6.3	
SCBA-14	14.0	6.3	
SCBA-15	15.0	6.3	
SCBA-16	16.0	6.3	

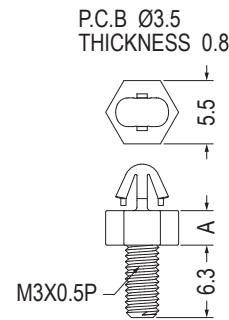
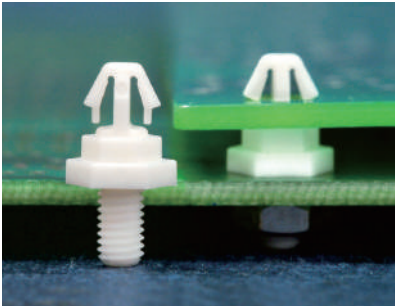

Part No.	A	Package
SCBC-3	3.0	1000
SCBC-4.75	4.76	
SCBC-5.5	5.5	

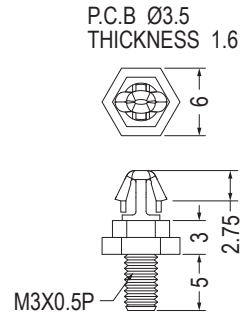

Part No.	Package
SCBB-3	1000

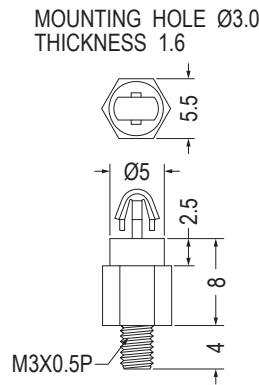
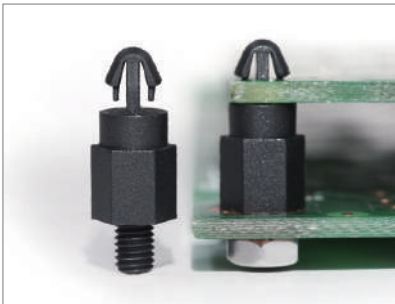

Part No.	Package
SCBD-8	1000

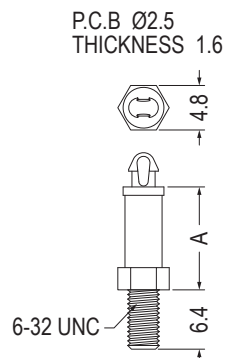
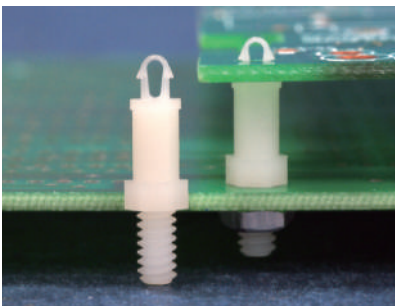

Part No.	A	Package
SCBS632-3.2	3.2	1000
SCBS632-4.8	4.8	
SCBS632-6.4	6.4	
SCBS632-7.9	7.9	
SCBS632-9.5	9.5	
SCBS632-11.1	11.1	
SCBS632-12.7	12.7	
SCBS632-14.3	14.3	
SCBS632-15.9	15.9	

PC板間隔柱 SPACER SUPPORT

用途：PC板端直接壓入固定，另一端可配合螺母或攻牙。

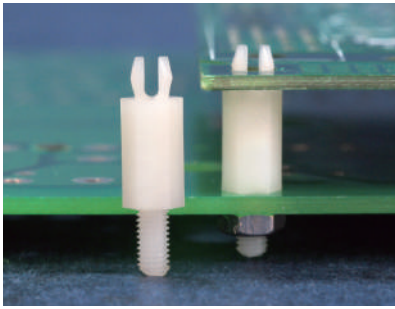

- Material: Nylon 66 (UL)
- Flame Class: 94V-2/94V-0
- Color: Natural/Black
- Unit: mm

MOUNTING HOLE $\varnothing 3.9\sim\varnothing 4.0$
THICKNESS 1.6

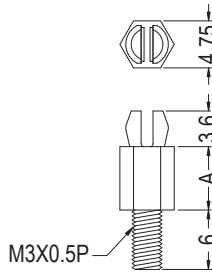

MOUNTING HOLE $\varnothing 3.9\sim\varnothing 4.0$
THICKNESS 1.6

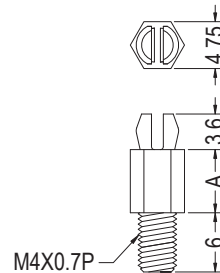

MOUNTING HOLE $\varnothing 3.0$
THICKNESS 1.2

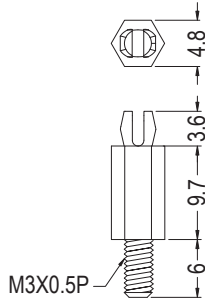

Part No.	Package
MSPA3-9.7	1000

Part No.	A	Package
MSPG3-3.2	3.2	1000
MSPG3-4.8	4.8	
MSPG3-6.4	6.4	
MSPG3-9.5	9.5	
MSPG3-12.7	12.7	
MSPG3-15.9	15.9	
MSPG3-19.1	19.1	
MSPG3-22.2	22.2	

Part No.	A	Package
MSPG4-3.2	3.2	1000
MSPG4-4.8	4.8	
MSPG4-6.4	6.4	
MSPG4-9.5	9.5	
MSPG4-12.7	12.7	
MSPG4-15.9	15.9	
MSPG4-19.1	19.1	
MSPG4-22.2	22.2	

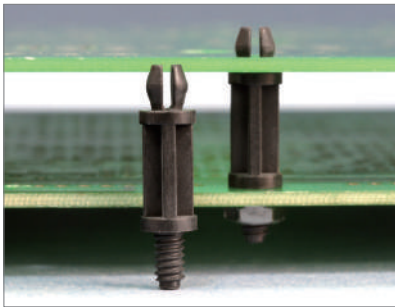

MOUNTING HOLE: $\varnothing G$
THICKNESS 2.1

MOUNTING HOLE: $\varnothing G$
THICKNESS 1.6

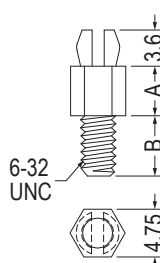
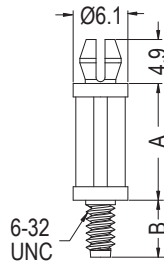

【 MSPS-13 】

Part No.	A	B	G	Package
MSPS-2S	2.0	3.0	4.0	2000
MSPS-3	3.2	6.0	4.0	
MSPS-5	4.8	6.0	3.9~4.0	1000
MSPS-6	6.4	6.0	3.9~4.0	
MSPS-12.7	12.7	6.0	3.9~4.0	
MSPS-13	13.0	6.35	4.0	
MSPS-15.9	15.9	6.0	3.9~4.0	
MSPS-19.1	19.1	6.0	3.9~4.0	
MSPS-22.2	22.2	6.0	3.9~4.0	

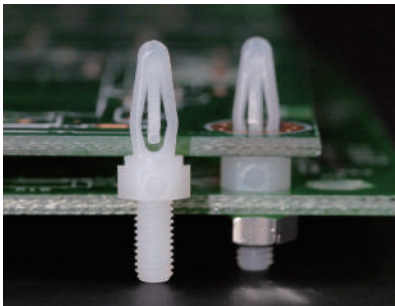

MOUNTING HOLE $\varnothing 3.2$
THICKNESS 1.6

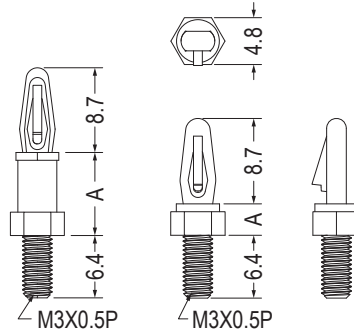

【 SCB3-12.7 】

Part No.	A	Package
SCB3-3.2	3.2	1000
SCB3-9.5	9.5	
SCB3-12.7	12.7	

MOUNTING HOLE $\varnothing 3.4$
THICKNESS 1.6

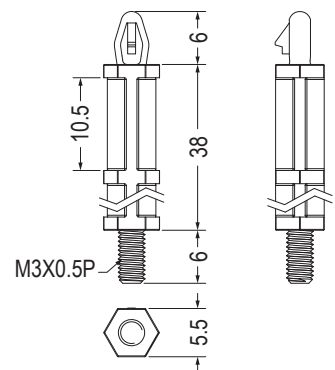

Part No.	Package
SCB3-38	1000

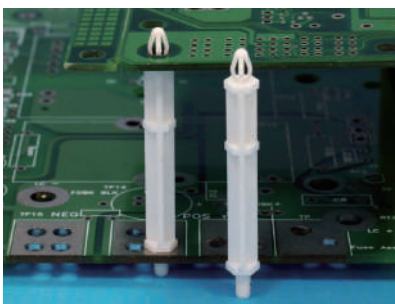

PC板間隔柱 SPACER SUPPORT

用途：PC板端直接壓入固定，另一端可配合螺母或攻牙。

1

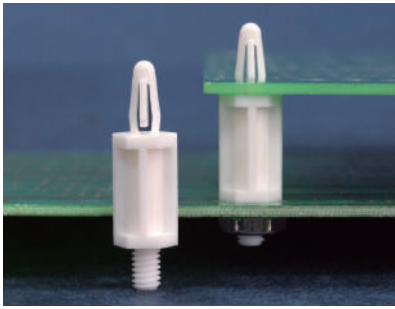

- Material: Nylon 66 (UL)
- Flame Class: 94V-2/94V-0
- Color: Natural/Black
- Unit: mm

MOUNTING HOLE $\varnothing 4.0$
THICKNESS 1.6

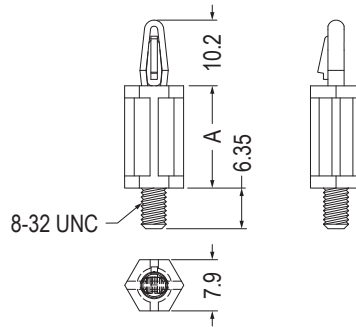

Part No.	A	Package
SCB832-6.35	6.35	1000
SCB832-12.7	12.7	
SCB832-15.9	15.9	
★SCB832-19	19.05	

MOUNTING HOLE $\varnothing 4.0$
THICKNESS 1.6

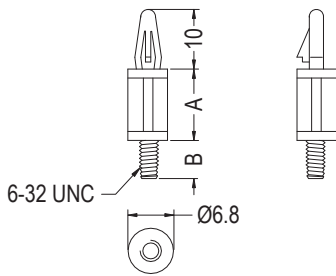

Part No.	A	B	Package
SCB-6	6.3	7.8	1000
SCB-10	9.5	7.8	
SCB-12	12.7	7.8	
SCB-15	15.9	7.8	
SCB-15A	15.9	4.8	

MOUNTING HOLE $\varnothing 4.0$
THICKNESS 1.6

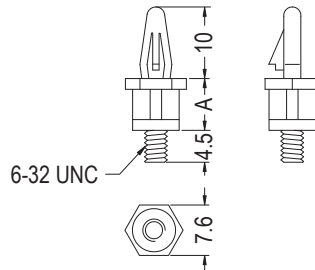

Part No.	A	Package
SCB-8.5S	8.5	1000
SCB-10SA	10.0	
SCB-10SA	10.0	

MOUNTING HOLE $\varnothing 4.0$
THICKNESS 1.2~1.7

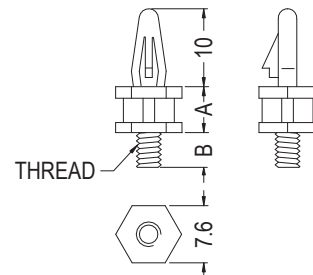

Part No.	A	B	Thread	Package
SCB-6SM3	6.3	4.8	M3X0.5P	1000
SCB-6S	6.3	4.8	6-32 UNC	
SCB-8S	8.0	4.5	6-32 UNC	
SCB-10S	10.0	4.5	6-32 UNC	
SCB-10S	10.0	4.5	6-32 UNC	

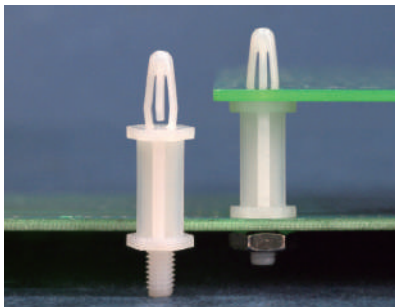

MOUNTING HOLE $\varnothing 4.0$
THICKNESS: T

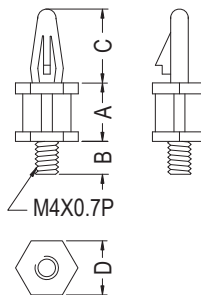

Part No.	A	B	C	D	T	Package
SCB4-6	6.3	4.8	10.7	7.6	1.2~1.7	1000
SCB4-6A	6.3	6.4	10.7	7.6	1.2~1.7	
SCB4-9.5	9.5	6.4	10.2	7.7	1.6	
SCB4-16	15.9	6.4	10.0	8.0	1.6~1.8	

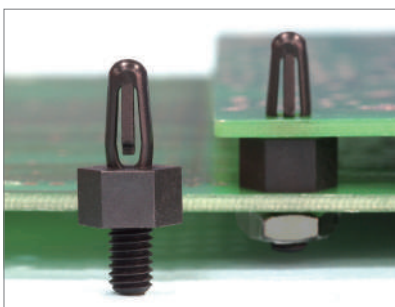

MOUNTING HOLE $\varnothing 4.0$
THICKNESS: T

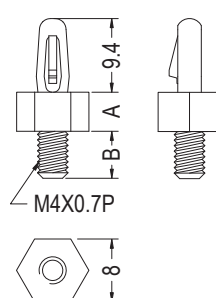

Part No.	A	B	T	Package
SCB4-4	4.0	6.4	2.0	1000
SCB4-5	5.0	6.0	1.6	

MOUNTING HOLE $\varnothing 4.0$
THICKNESS 1.6

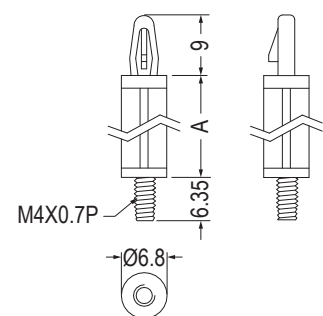

Part No.	A	Package
SCB4-23.8	23.8	1000
SCB4-30	30.0	

PC板間隔柱 SPACER SUPPORT

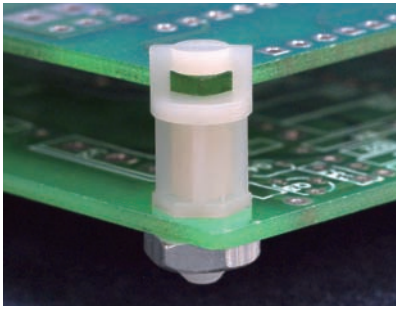

- Material: Nylon 66 (UL)
- Flame Class: 94V-2/94V-0
- Color: Natural/Black
- Unit: mm

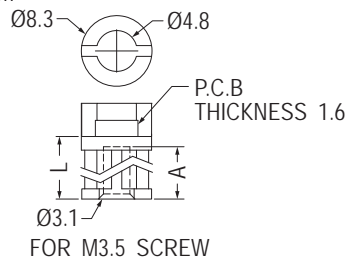

用途：PC板端直接壓入固定，另一端可配合螺母或攻牙。

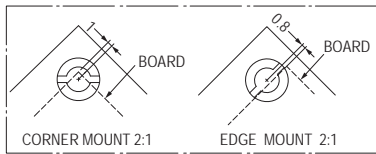
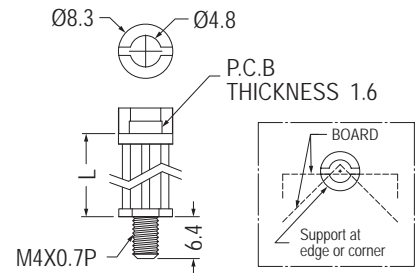

Part No.	A	L	Package
TCEH-6.4	5.2	6.4	1000
TCEH-9.5	7.9	9.5	
TCEH-12.7	7.9	12.7	
TCEH-15.9	7.9	15.9	

Part No.	L	Package
TCEP4-6.4	6.4	1000
TCEP4-9.5	9.5	
TCEP4-12.7	12.7	
TCEP4-15.9	15.9	

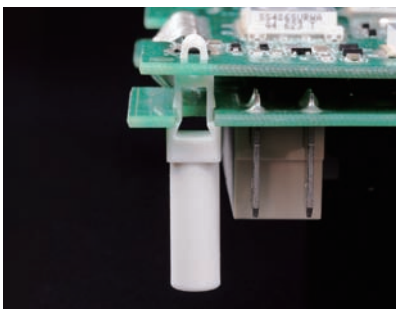

- Material: PBT (UL)+GF
- Flame Class: 94V-0
- Color: Natural
- Unit: mm

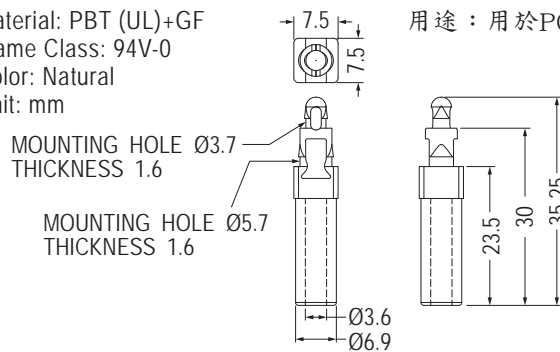

用途：用於PC板之間隔柱。



Part No.	Package
THCS-2	1000

觸控間隔柱 TOUCH CONTROL SPACER

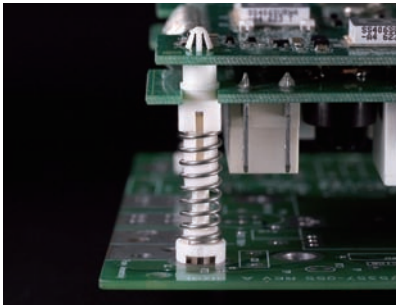

- Material: Nylon 66 (UL)
- Flame Class: 94V-0
- Spring Material: SUS
- Color: Natural
- Unit: mm
- Patented (專利品)

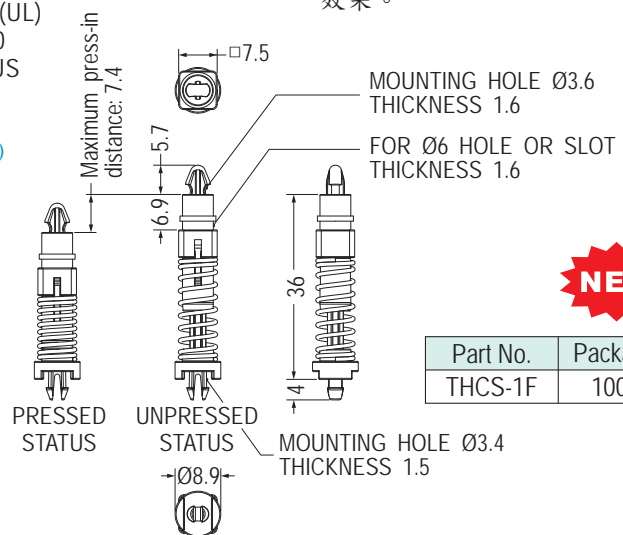

用途：固定觸控面板於機板上，具減震效果。



Part No.	Package
THCS-1F	1000

導電間隔柱 SPACER SUPPORT

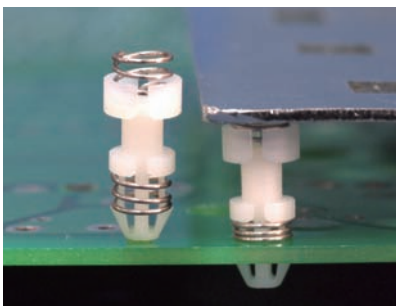

- Material: Nylon 66 (UL)
- Flame Class: 94V-2/94V-0
- Color: Natural/Black
- Unit: mm
- USA Patented (美國專利品)

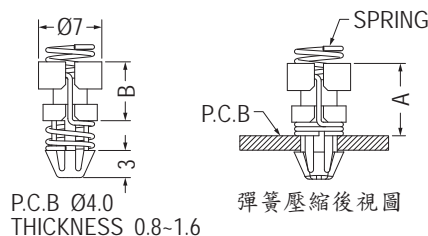

用途：支撐PC板與機板間之導電。

Part No.	A	B	Package
ALUCA-8	8.0	6.5	1000
ALUCA-9	9.0	7.5	
ALUCA-10	10.0	8.5	
ALUCA-12	12.0	10.5	
ALUCA-14	14.0	12.5	
ALUCA-16	16.0	14.5	

導光板間隔柱 PILLAR SUPPORT

用途：用於支撐液晶面板，高導光，高反射，高透光。

- Material: PC (UL)
- Flame Class: 94V-2/94V-0
- Color: Natural/Transparent
- Unit: mm

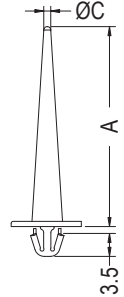
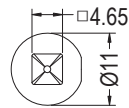
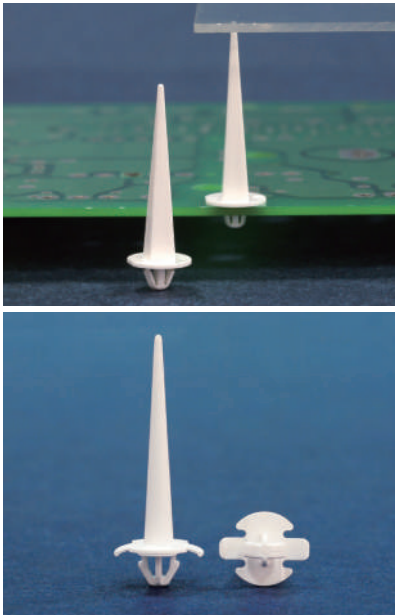

MOUNTING HOLE THICKNESS: T

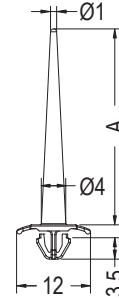
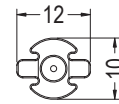

P.C.B Ø4.5 THICKNESS 0.8~1.0

Part No.	A	C	T	Package
MCFG-3010	30.5	0.8	1.0	1000
MCFG-35810	35.8	1.05	1.05	

Part No.	A	Package
MCFD-2810	28.0	1000
MCFD-3210	32.0	

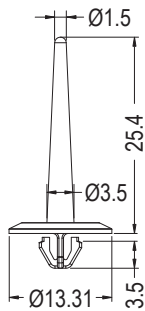

P.C.B Ø4.5 THICKNESS: T

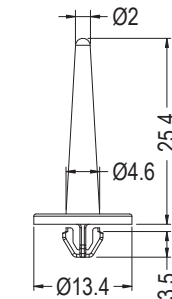

P.C.B Ø4.5 THICKNESS 0.6~0.8

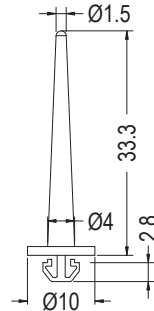

P.C.B Ø4.5 THICKNESS 1.0

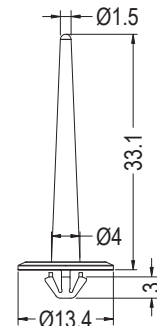

MOUNTING HOLE Ø4.6 THICKNESS: T

Part No.	T	Package
MCFA-2508	0.6~0.8	500
MCFA-2511	0.8~1.1	

Part No.	Package
MCFC-2508	1000

Part No.	Package
MCFL-3310	1000

Part No.	T	Package
MCF-3305	0.6	500
MCF-3308	0.5~0.8	

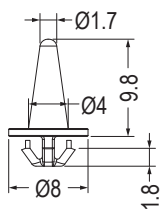

MOUNTING HOLE Ø4.6 THICKNESS 1.0

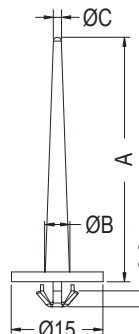

MOUNTING HOLE Ø5.2 THICKNESS: T

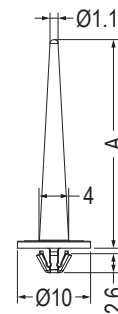

MOUNTING HOLE Ø3.8 THICKNESS: T

Part No.	Package
★MCFF-25	1000

Part No.	A	B	C	T	Package
MCF-2310	23.5	4.5	1.6	0.8~1.0	500
MCF-4213	40.0	3.95	1.3	1.0~1.3	

Part No.	A	T	Package
MCFO-2806	28.5	0.5~0.65	1000
MCFO-2906	29.5	0.5~0.65	
MCFO-2908	29.5	0.6~0.8	

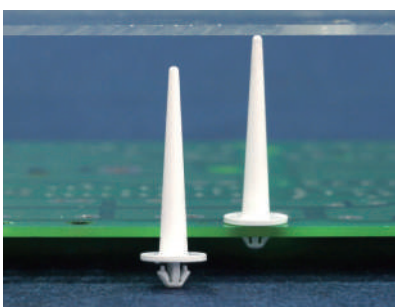

MOUNTING HOLE: ØG THICKNESS: T

Part No.	B	C	D	G	T	Package
MCFJ-4	3.9	1.06	2.65	3.8	1.0	1000
MCFJ-6	4.3	1.5	2.65	3.8	1.25	
MCFJ-7	3.9	1.06	2.5	3.5	0.8	

導光板間隔柱 PILLAR SUPPORT

用途：用於支撐液晶面板，高導光，高反射，高透光。

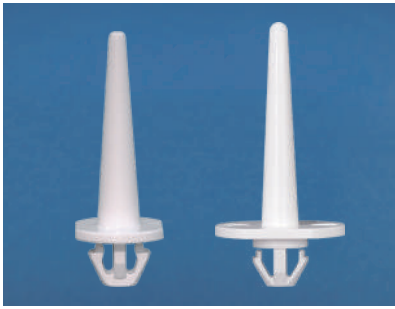

- Material: PC (UL)
- Flame Class: 94V-0
- Color: Natural
- Unit: mm

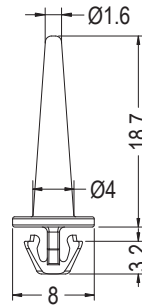

MOUNTING HOLE Ø4.6
THICKNESS 1.3

Part No.	Package
MCFE-20	1000

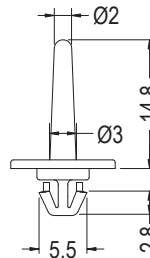

MOUNTING HOLE Ø4.5
THICKNESS 1.2

Part No.	Package
MCFE-18	1000

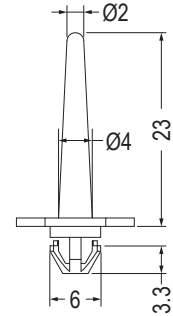

MOUNTING HOLE Ø5.5
THICKNESS 0.8

Part No.	Package
MCFE-21	1000

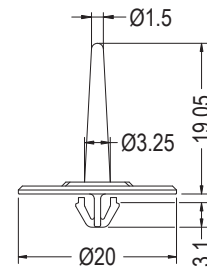
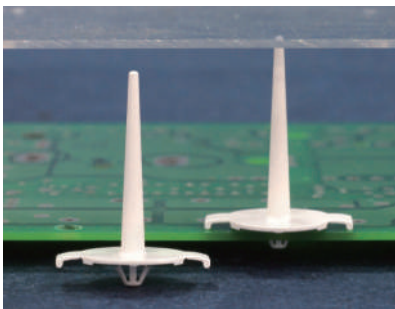

MOUNTING HOLE Ø4.7
THICKNESS 1.0

Part No.	Package
MCFE-11	1000

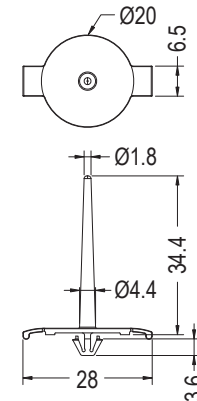

P.C.B Ø5.0
THICKNESS 0.75~1.05

Part No.	Package
MCFD-1	500

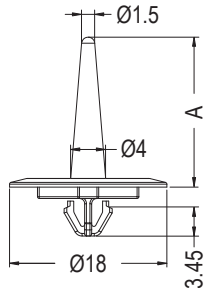
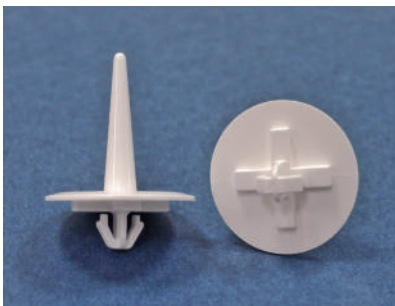

P.C.B Ø4.6
THICKNESS: T

Part No.	A	T	Package
MCFE-9	17.16	0.6~0.8	1000
MCFE-10	31.42	0.8	500
MCFE-14	18.0	0.8	1000



- Material: Nylon 66 (UL)
- Flame Class: 94V-0
- Color: White
- Unit: mm

- Material: PC (UL)
- Flame Class: 94V-2/94V-0
- Color: Transparent
- Unit: mm

- Material: PC (UL)
- Flame Class: 94V-2/94V-0
- Color: Natural/Transparent
- Unit: mm

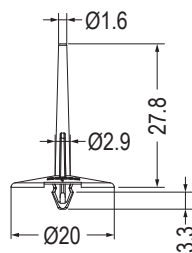

P.C.B Ø3.0
THICKNESS 0.65

Part No.	Package
MCFM-2807	1000

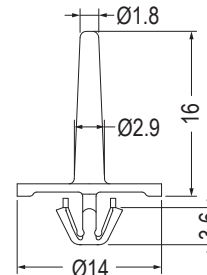

HOLE IN CHASSIS Ø5.0
THICKNESS 1.0

Part No.	Package
MCFE-24	1000

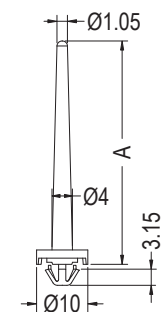

P.C.B Ø5.2
THICKNESS 0.6~0.8

Part No.	A	Package
MCF-428	42.6	500
MCF-2908	29.0	500

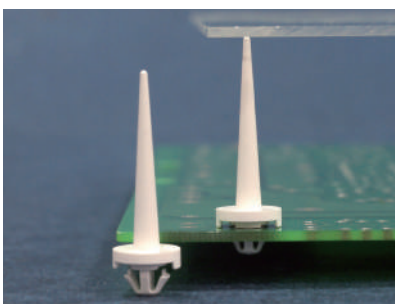

導光板間隔柱 PILLAR SUPPORT

用途：用於支撐液晶面板，高導光，高反射，高透光。

1

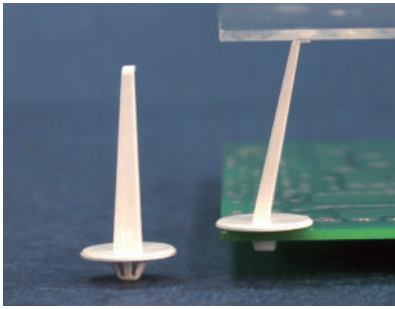

- Material: PC (UL)
- Flame Class: 94V-2/94V-0
- Color: Natural/Transparent
- Unit: mm

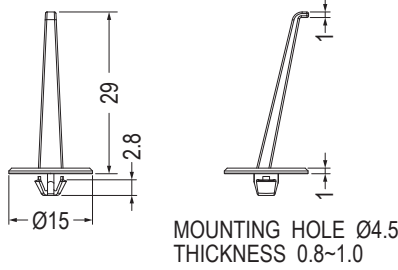

Part No.	Package
MCF-1	1000

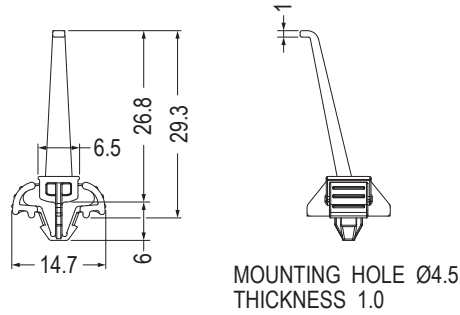
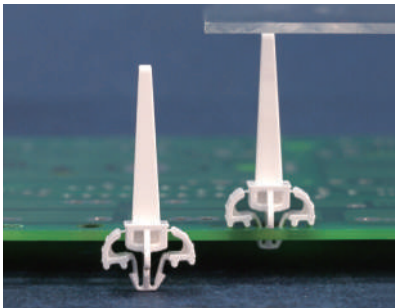

• Patented (專利品)

Part No.	Package
MCFF-5	1000

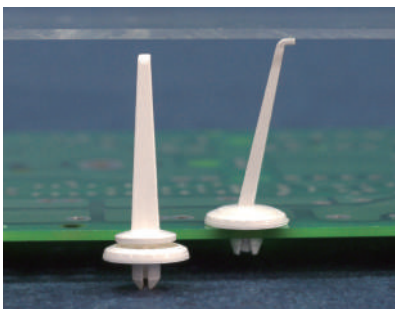

- Material: PC (UL)
- Flame Class: 94V-0
- Color: Natural
- Unit: mm
- Patented (專利品)

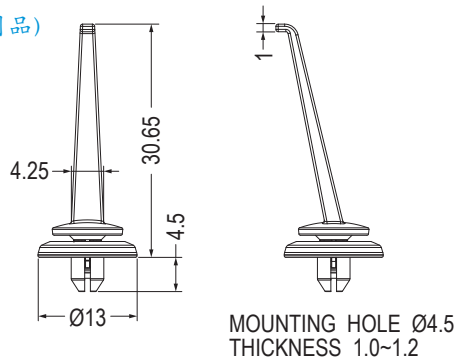

Part No.	Package
MCFF-6	500

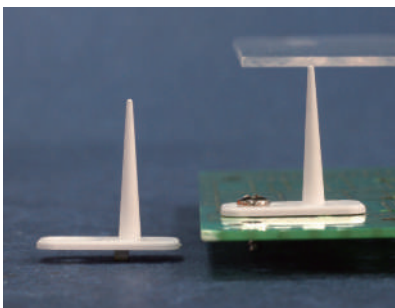

- Material: PC (UL)
- Flame Class: 94V-0
- Color: White
- Unit: mm

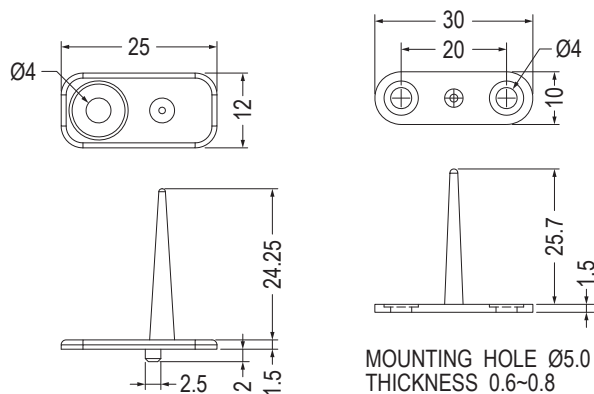

Part No.	Package
MCFJ-1	1000

Part No.	Package
MCFJ-2	1000

Part No.	Package
★MCFP-33	1000

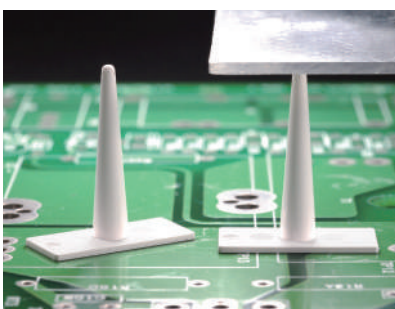

導光板間隔柱 PILLAR SUPPORT

用途：用於支撐液晶面板，高導光，高反射，高透光。

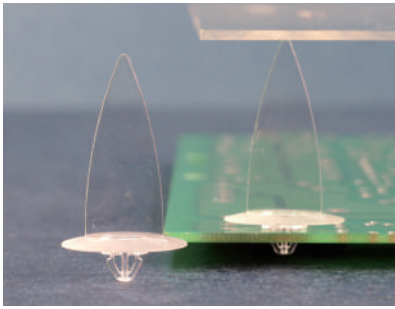

- Material: PC (UL)
- Flame Class: 94V-2/94V-0
- Color: Transparent
- Unit: mm

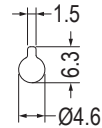
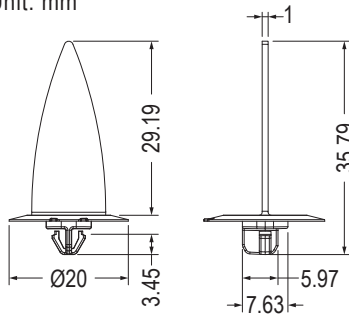

MOUNTING HOLE THICKNESS 0.8

Part No.	Package
MCFF-15	1000

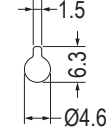
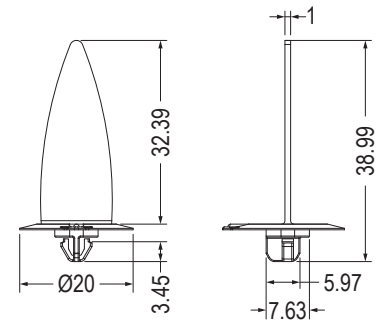

MOUNTING HOLE THICKNESS 0.8

Part No.	Package
MCFF-16	1000

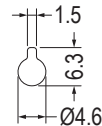
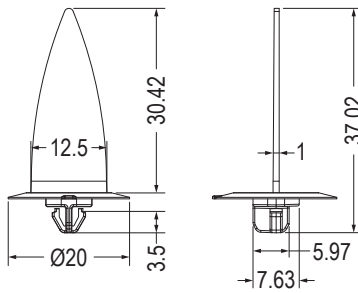
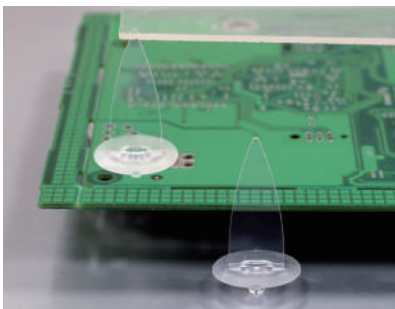

MOUNTING HOLE THICKNESS 0.8

Part No.	Package
MCFF-13	1000

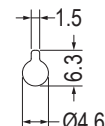
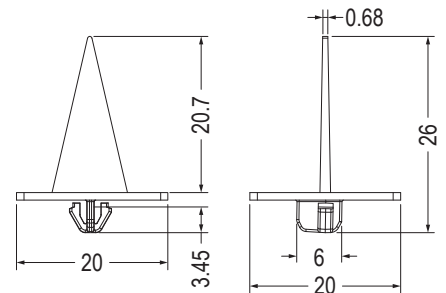

MOUNTING HOLE THICKNESS 0.8

Part No.	Package
MCFF-17	1000



- Material: PC (UL)/94V-0
- Color: Transparent
- Base Material: Nylon 66 (UL)/94V-0
- Base Color: Natural
- Unit: mm
- Patented (專利品)

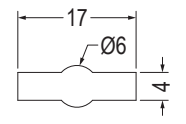
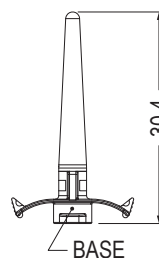
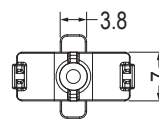

MOUNTING HOLE THICKNESS 0.5~1.0

Part No.	Package
MCFF-7	1000

導光板間隔柱 PILLAR SUPPORT

用途：用於支撐液晶面板，高導光，高反射，高透光。

1

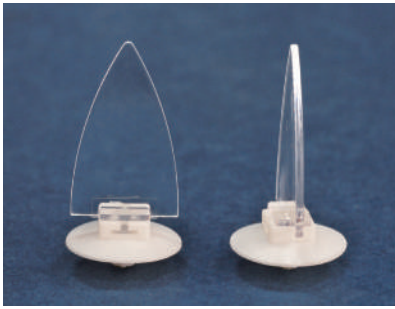

- Material1: PC (UL)
- Material2: Nylon 66 (UL)
- Flame Class: 94V-2/94V-0
- Color1: Transparent
- Color2: Natural/White
- Unit: mm
- Patented (專利品)

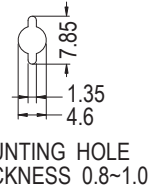
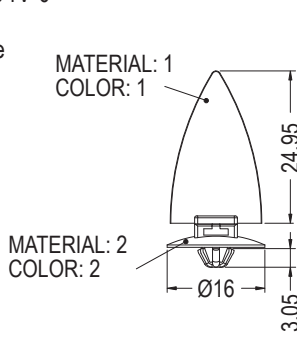

Part No.	Package
MCFF-12	1000

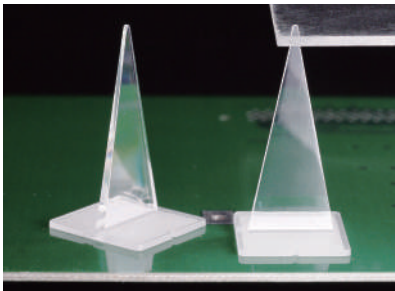

- Material: PC (UL)
- Flame Class: 94V-2/94V-0
- Color: Transparent
- Unit: mm

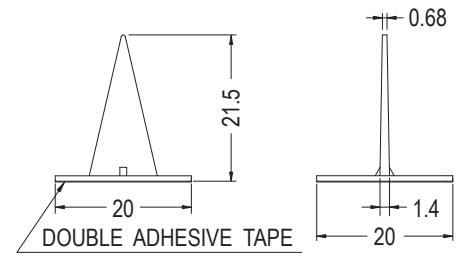
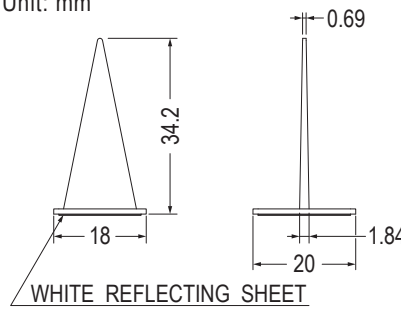

Part No.	Package
★MCFP-30	1000

Part No.	Package
MCFP-5	1000

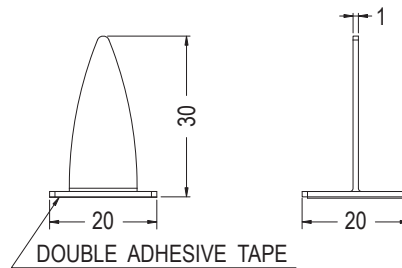
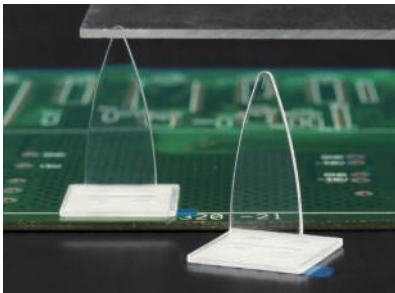
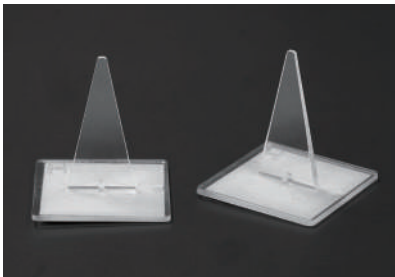

Part No.	Package
MCFP-7	1000

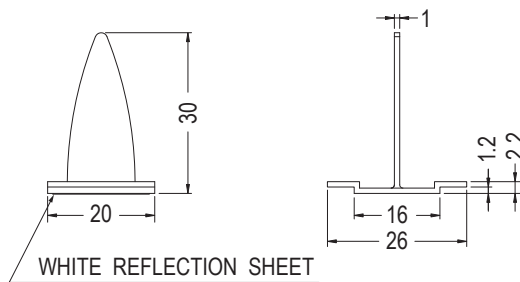
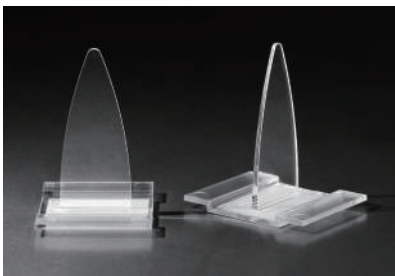

Part No.	Package
MCFP-9	1000

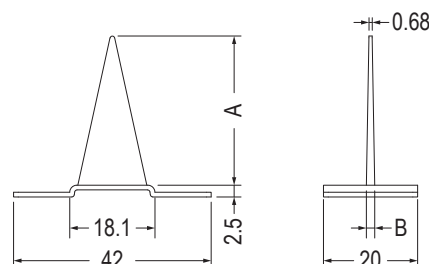
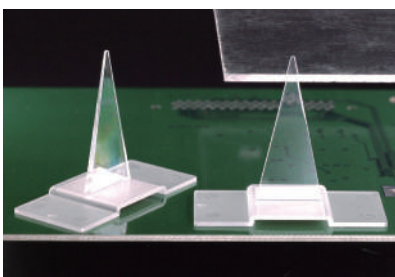

NEW

Part No.	A	B	Package
MCFP-31	31.7	1.78	500
MCFP-32	32.0	1.8	

導光板間隔柱 PILLAR SUPPORT

用途：用於支撐液晶面板，高導光，高反射，高透光。

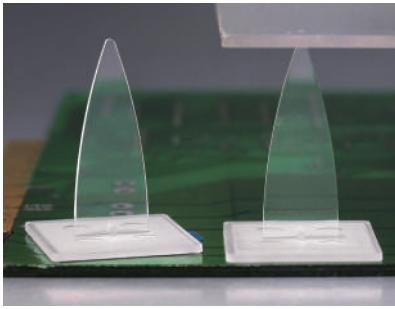

- Material: PC (UL)
- Flame Class: 94V-2/94V-0
- Color: Transparent
- Unit: mm

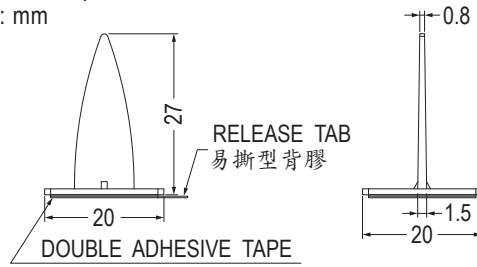

Part No.	Package
MCFP-18	1000

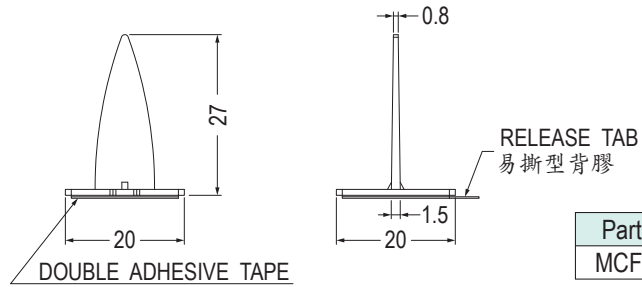
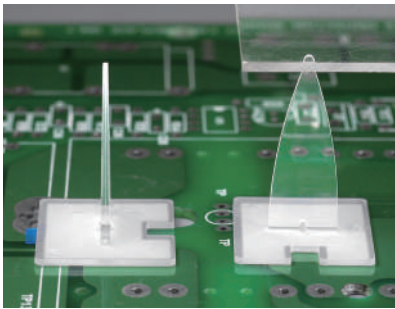

Part No.	Package
MCFP-29	1000

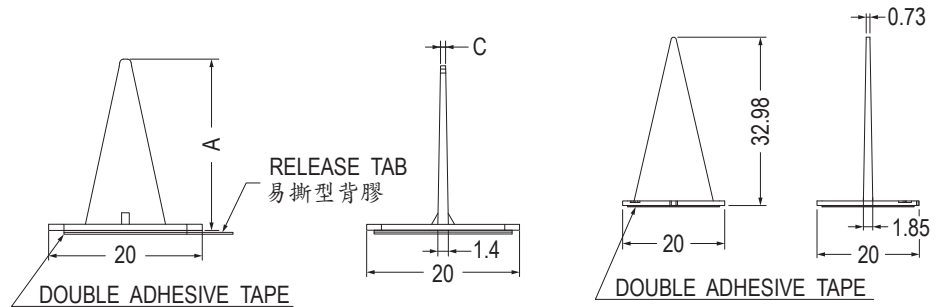
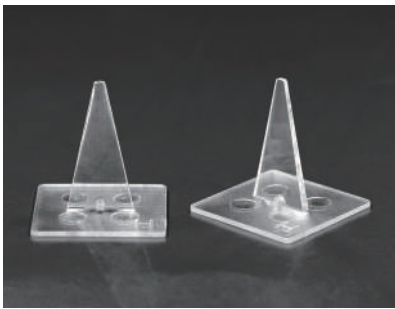

Part No.	A	C	Package
MCFP-12	20.7	0.71	1000
MCFP-25	22.3	0.68	

Part No.	Package
MCFP-17-1	1000

PC板間隔柱 SPACER SUPPORT

用途：適用於NGFF卡於機板上，免工具，易拆卸。



- Material: Nylon 66 (UL)
- Flame Class: 94V-2/94V-0
- Color: Natural/Black/Green/Blue
- Unit: mm

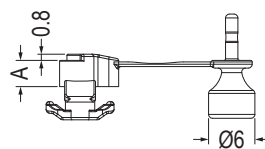

[ULCN3.4-2.1]

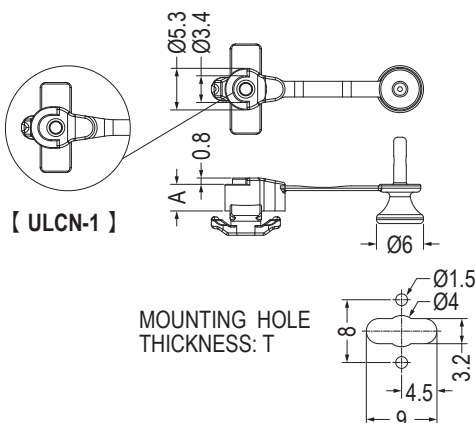
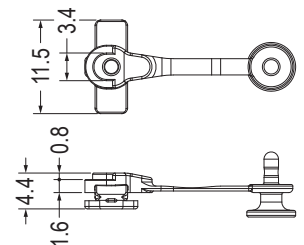

[ULCN-1]

MOUNTING HOLE THICKNESS: T

Part No.	A	T	Package
ULCN-1	1.7	2.1~2.4	1000
ULCN1.7-2.4	1.7	2.1~2.4	
ULCN2.2-1.2	2.2	1.2	
ULCN2.5-1.6	2.5	0.8~1.6	
ULCN2.5-2.6	2.5	1.8~2.6	
ULCN2.5-2.9	2.5	2.1~2.9	
ULCN3.4-0.8	3.4	0.8	
ULCN3.4-2.1	3.4	2.13	
ULCN6.3-1.6	6.3	1.6	

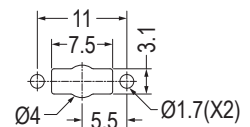

MOUNTING HOLE THICKNESS 0.6

- Flame Class: 94V-2
- Color: Green

Part No.	Package
ULCN-3	1000

PC板間隔柱 SPACER SUPPORT

用途：適用於NGFF卡於機板上，免工具，易拆卸。

1

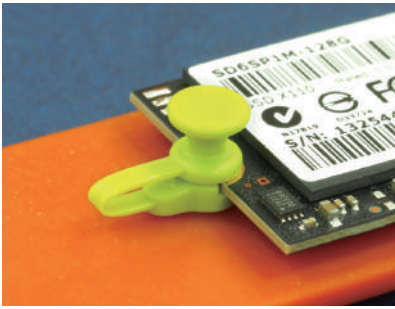

- Material: Nylon 66 (UL)
- Flame Class: 94V-2/94V-0
- Color: Natural/Black/Green/Blue
- Unit: mm
- Patented (專利品)

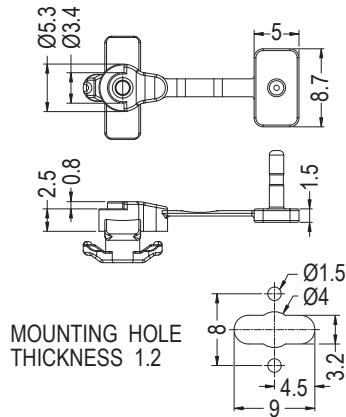
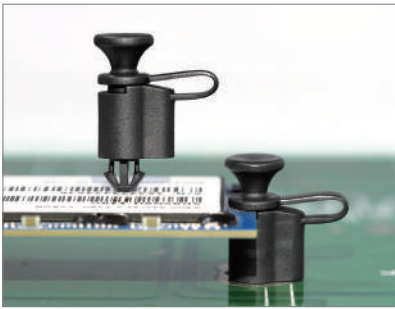

Part No.	Package
ULCN2.5-1.2	1000

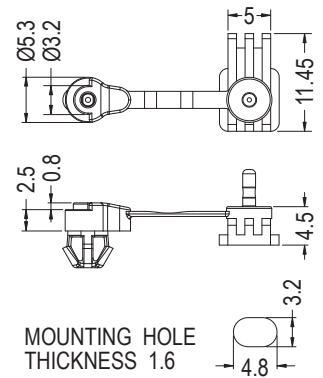

Part No.	Package
ULCW2.5-1.6	1000

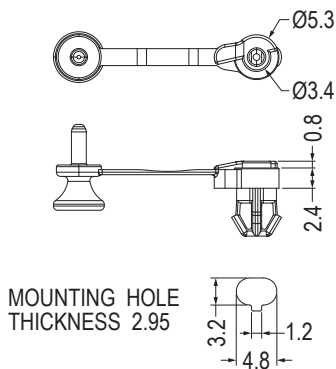

Part No.	Package
★ULCO2.4A-3.1	1000

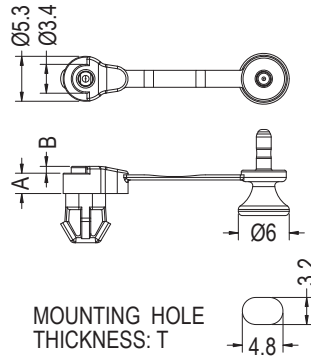

Part No.	A	B	T	Package
ULCO2.1-2	2.08	0.81	2.0	1000
ULCO2.4-2.1	2.4	0.8	2.1	
ULCO2.4-3.1	2.4	0.8	2.95	
ULCO2.5-1.6	2.5	0.8	1.6	
ULCO2.5-2.2	2.5	0.8	2.2	
ULCO2.5-2.4	2.5	0.8	2.4	
ULCO2.5-4.2	2.5	0.8	4.2	
ULCO6.6-2.6	6.6	0.8	2.46	

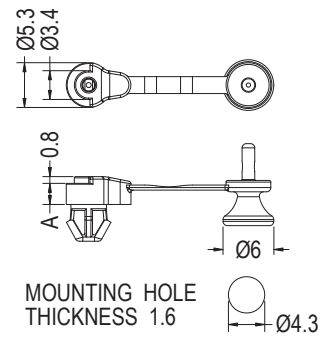

Part No.	A	Package
ULCOG2.5-1.6	2.5	1000
ULCOG6.3-1.6	6.3	

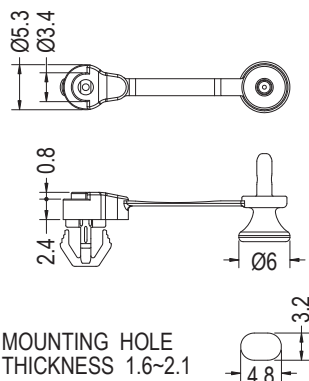

Part No.	Package
ULCOJ-1	1000

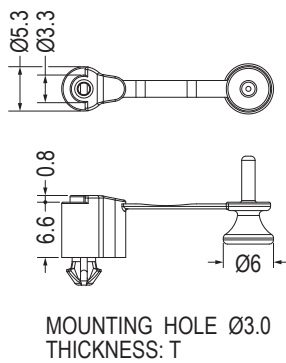

Part No.	T	Package
★ULCN6.6-1.2	1.2	1000
★ULCN6.6-1.6	1.5~1.6	

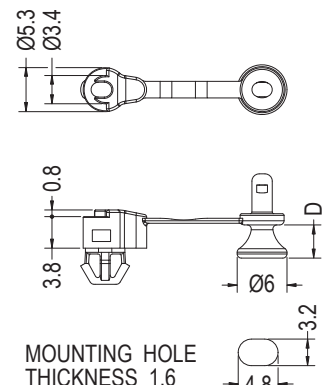

Part No.	D	Package
ULCO3.8-1.6S	2.5	1000
ULCO3.8-1.6	4.0	

PC板間隔柱 SPACER SUPPORT

用途：適用於NGFF卡於機板上，免工具，易拆卸。

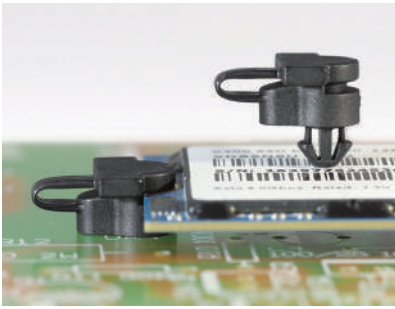

- Material: Nylon 66 (UL)
- Flame Class: 94V-2/94V-0
- Color: Natural/Black/Green/Blue
- Unit: mm
- Patented (專利品)

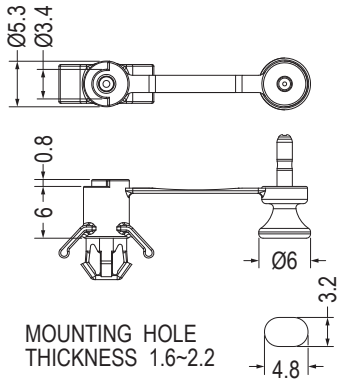

Part No.	Package
ULCOB-1	1000

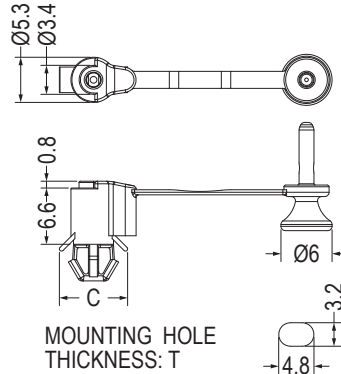

Part No.	C	T	Package
ULCO6.6-1.6	8.0	1.6	1000
ULCO6.6-2	8.0	1.9~2.1	
ULCO6.6-3.1	8.3	2.7~3.3	

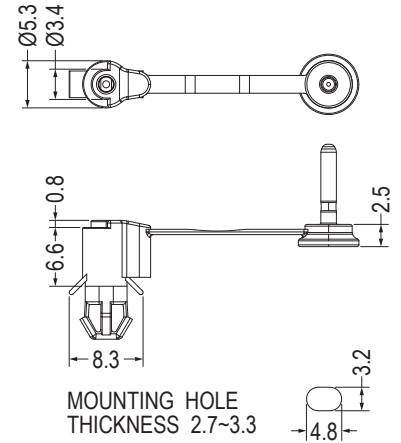

Part No.	Package
ULCO6.6-3.1S	1000

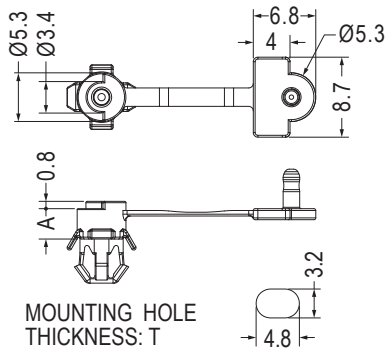

Part No.	A	T	Package
ULCOB3.3-2.3	3.3	2.27	1000
★ULCOB6-1.6	6.0	1.6	
ULCOB6-2.3	6.0	2.27	

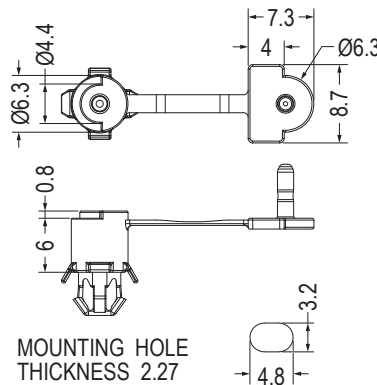

Part No.	Package
ULCOB-2	1000

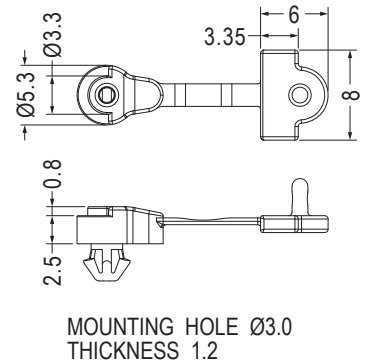

Part No.	Package
★ULCNF2.5-1.2	1000

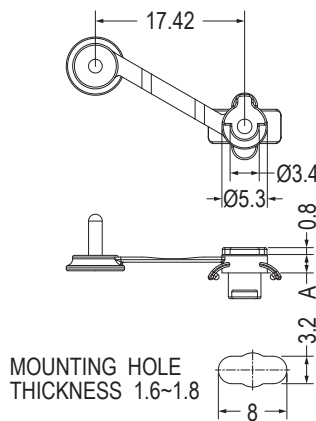

Part No.	A	Package
ULCNA2.5-1.8	2.15	1000
ULCNA2.5-1.8S	2.45	
ULCNA4-1.8	4.0	

- Material: Nylon 66 (UL)
- Flame Class: 94V-2/94V-0
- Color: Black
- Unit: mm

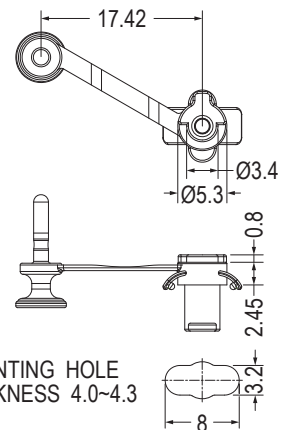

Part No.	Package
ULCNA2.5-4.3	1000

PC板間隔柱 SPACER SUPPORT

用途：適用於NGFF卡於機板上，免工具，易拆卸。



- Material: Nylon 66 (UL)
- Flame Class: 94V-2/94V-0
- Color: Natural/Black/Green/Blue
- Unit: mm
- Patented (專利品)

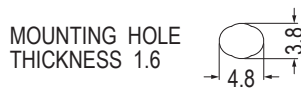
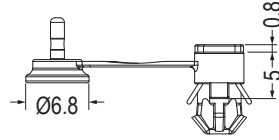
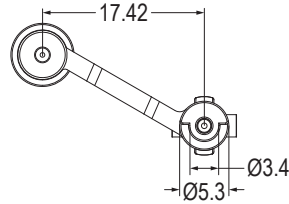

MOUNTING HOLE THICKNESS 1.6

Part No.	Package
ULCOA5-1.6A	1000

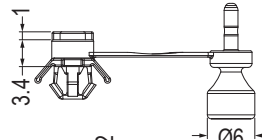
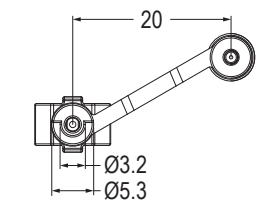

MOUNTING HOLE THICKNESS 1.6

Part No.	Package
ULCOB3.4-1.6	1000

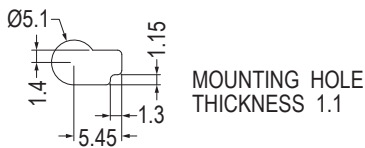
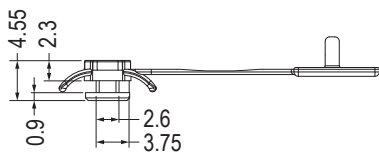
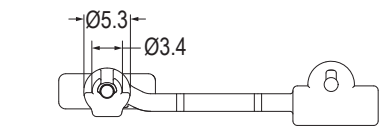

MOUNTING HOLE THICKNESS 1.1

Part No.	Package
ULCND1.5-1.1	1000

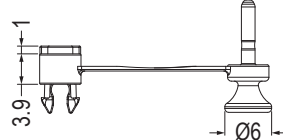
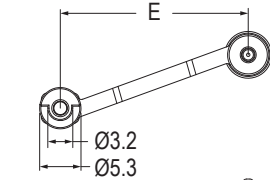

MOUNTING HOLE THICKNESS 1.6

Part No.	E	G	Package
ULCY-1	18.27	4.05	1000
ULCY3.9-1.6	24.1	4.0	

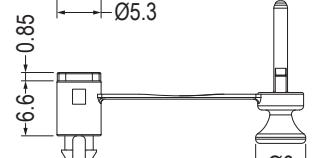
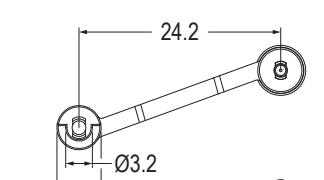

MOUNTING HOLE Ø3.4 THICKNESS 1.6

• Color: Black

Part No.	Package
ULCY-2	1000

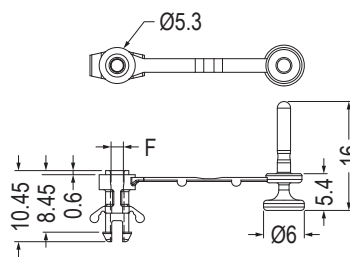
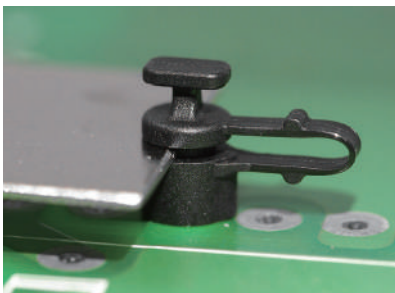

MOUNTING HOLE Ø3.5 THICKNESS 1.6~2.2

Part No.	F	Package
ULCOC-1	1.8	1000
ULCOC-9	1.77	

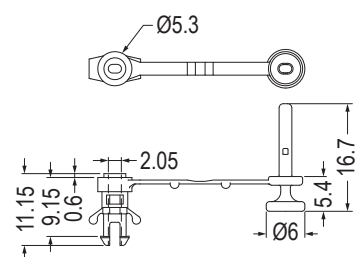

MOUNTING HOLE Ø3.5 THICKNESS 2.3~2.9

Part No.	Package
ULCOC-7L	1000

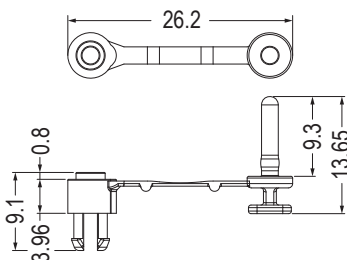

MOUNTING HOLE Ø4.0 THICKNESS 2.69

Part No.	Package
ULCOC-14	1000

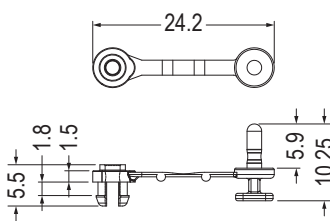

MOUNTING HOLE Ø4.0 THICKNESS 1.6

Part No.	Package
ULCOC-2	1000

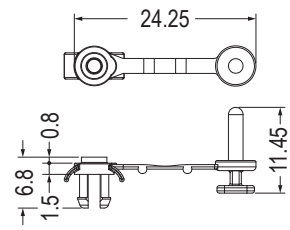

MOUNTING HOLE Ø4.0 THICKNESS 2.3~2.9

Part No.	Package
ULCOC-2L	1000

導電PC板間隔柱 CONDUCTIVE SPACER SUPPORT

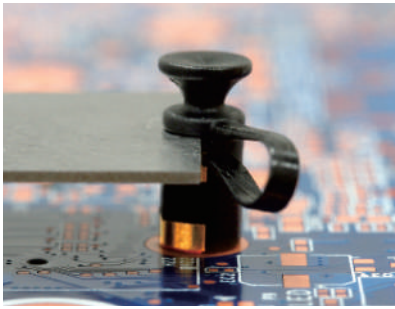

- Material: Nylon 66 (UL)
- Nut Material: Brass
- Flame Class: 94V-2/94V-0
- Color: Natural/Black
- Unit: mm
- Patented (專利品)

用途：適用NGFF卡於機板上，免工具，易拆卸，銅柱導電性佳，防E.M.I干擾。

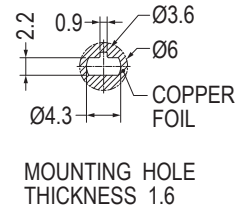
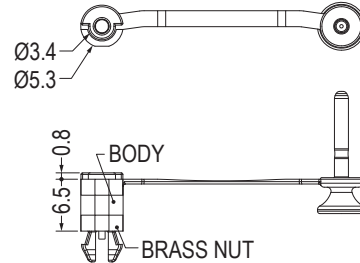
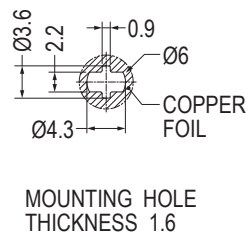
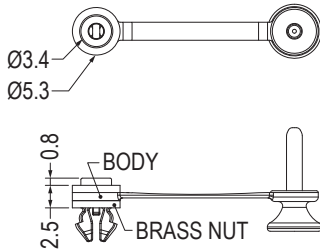

Part No.	Package
ULCOE-3	1000

Part No.	Package
ULCOE-4	1000

PC板間隔柱 SPACER SUPPORT

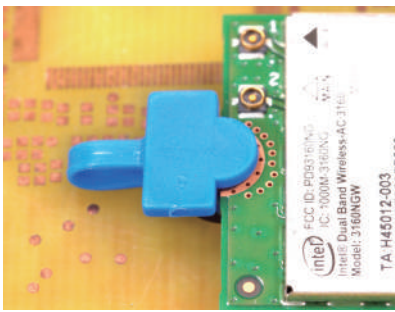

- Material: Nylon 66 (UL)
- Flame Class: 94V-2/94V-0
- Color: Natural/Black/Blue
- Unit: mm
- Patented (專利品)

用途：適用NGFF卡於機板上，免工具，易拆卸。

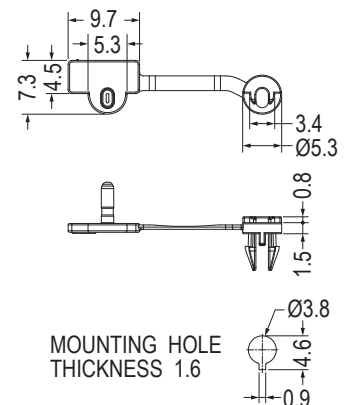
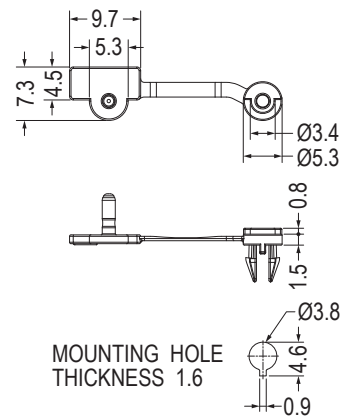

Part No.	Package
ULCOD1.5-1.6	1000

Part No.	Package
ULCOD-1	1000

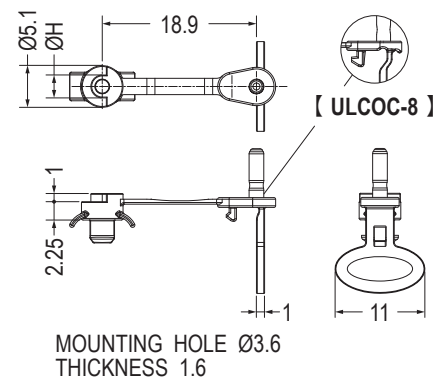
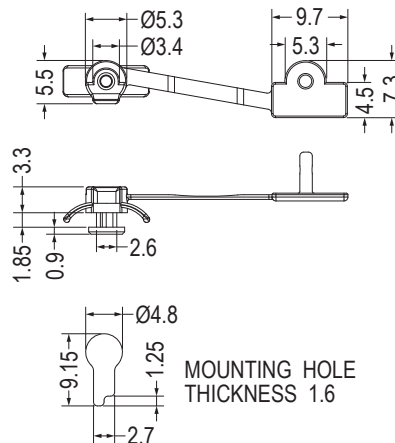

Part No.	Package
ULCND2.5-1.6	1000

Part No.	H	Package
ULCOC-4	3.4	1000
ULCOC-8	2.8	

PC板間隔柱 SPACER SUPPORT

用途：通用NGFF卡於機板上，免工具，易拆卸。

1



- Material: Nylon 66 (UL)
- Flame Class: 94V-2/94V-0
- Color: Natural/Black/Blue
- Unit: mm
- Patented (專利品)

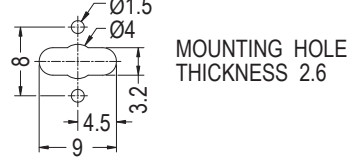
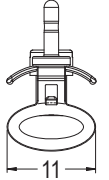
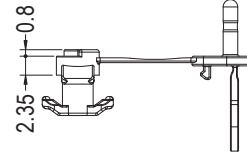
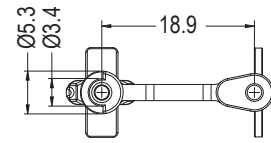
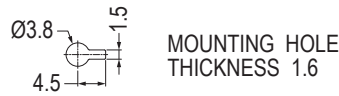
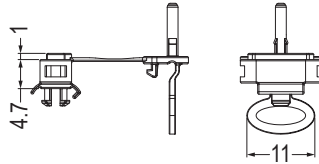
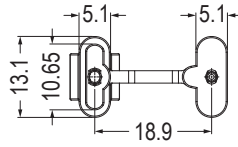

Part No.	Package
ULCOC-12	1000

Part No.	Package
ULCOC2.4-2.6	1000

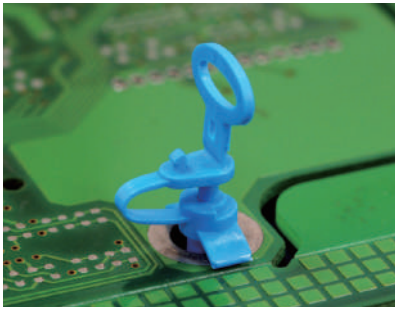

- Material: Nylon 66 (UL)
- Flame Class: 94V-2/94V-0
- Color: Green
- Unit: mm
- Patented (專利品)

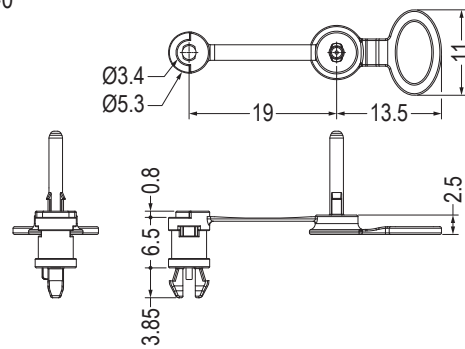

MOUNTING HOLE CHASSIS THICKNESS 1.6



Part No.	Package
ULCOM-1	1000

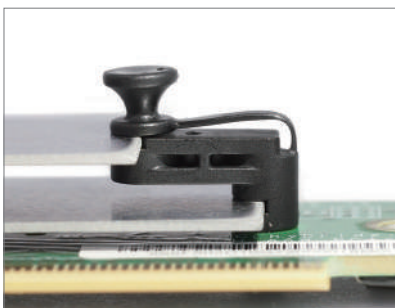

- Material: Nylon 66 (UL)
- Flame Class: 94V-2/94V-0
- Color: Black
- Unit: mm
- Patented (專利品)

用途：用於上下雙層NGFF卡之固定。

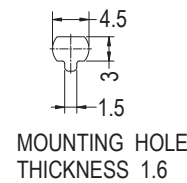
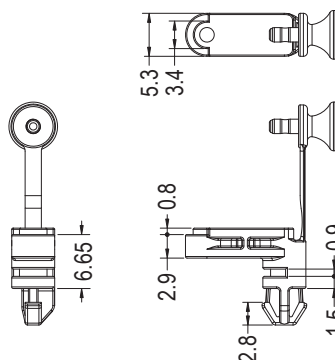

Part No.	Package
ULD-1	1000



使用說明
Installation Step

PC板間隔柱 SPACER SUPPORT

用途：適用上下雙層NGFF卡於機板上，免工具，易拆卸。

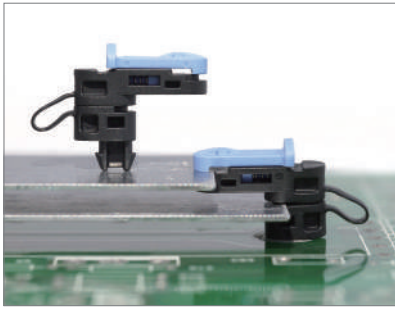

- Material: Nylon 66 (UL)
- Flame Class: 94V-0
- Base Color: Black
- Handle Color: Blue
- Unit: mm
- Patented (專利品)

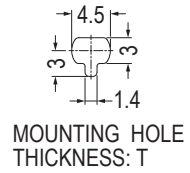
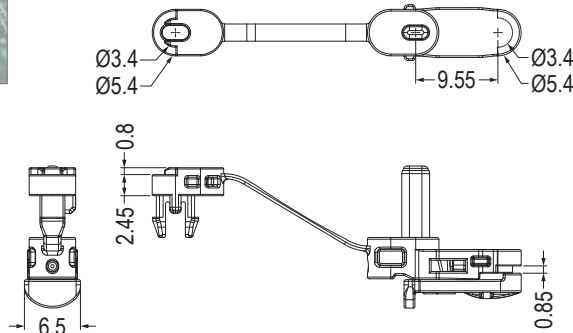
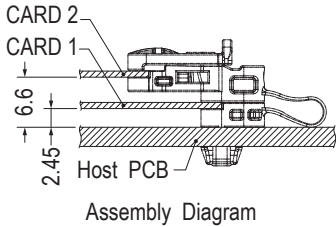

Part No.	T	Package
★ULCOF-9MF	1.93	1000
ULCOF-9F	2.36	

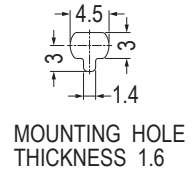
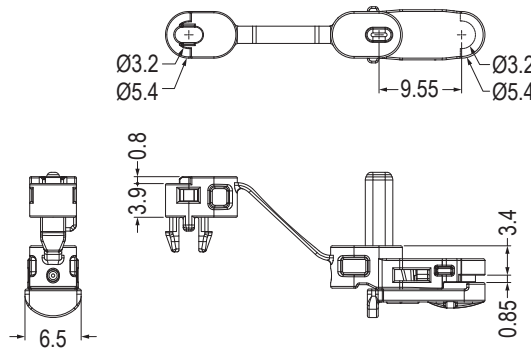
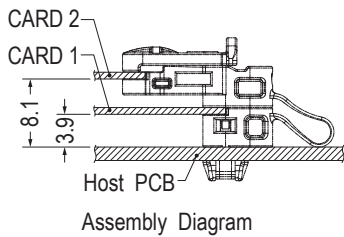

Part No.	Package
ULCOF-19F	1000

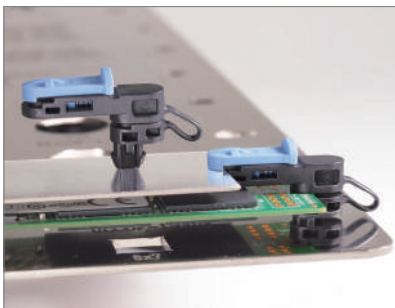

- Latch Base Material: Nylon 66 (UL)
- Latch Handle Material: Nylon 66 (UL)+GF
- Latch Spring Material: SWP Nickel Plated
- Flame Class: 94V-0
- Base Color: Black
- Handle Color: Blue
- Unit: mm
- Patented (專利品)

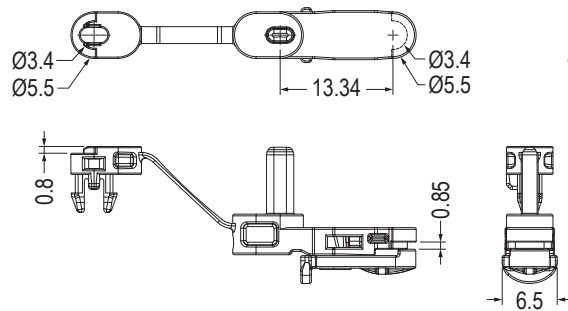
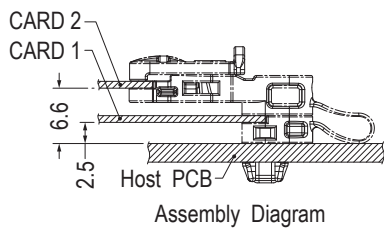

Part No.	Package
ULCOF-20F	1000



- Material: Nylon 66 (UL)
- Flame Class: 94V-0
- Color: Black
- Unit: mm
- Patented (專利品)

用途：適用NGFF卡於機板上，免工具，易拆卸。

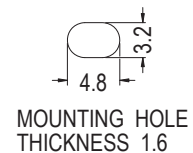
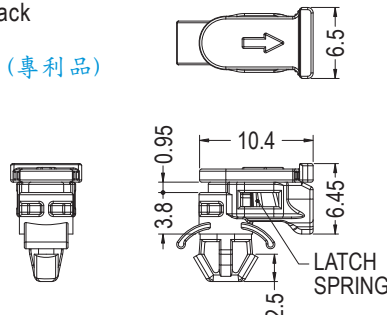

Part No.	Package
ULCOF-2F	1000

PC板間隔柱 SPACER SUPPORT

用途：通用NGFF卡於機板上，免工具，易拆卸。

1



- Material: Nylon 66 (UL)
- Flame Class: 94V-0
- Latch Base Color: Black
- Latch Cover Color: Blue
- Unit: mm
- Patented (專利品)

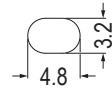
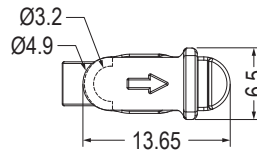

MOUNTING HOLE THICKNESS 1.6

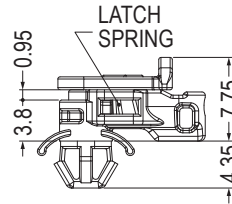
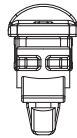

Part No.	Package
ULCOF-10F	1000

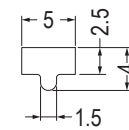
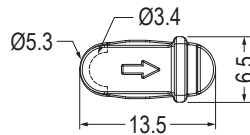
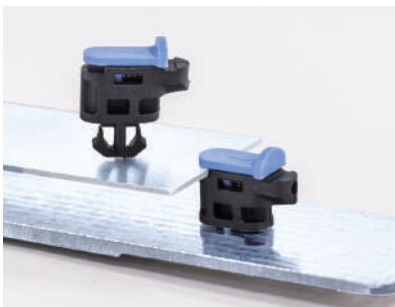

MOUNTING HOLE THICKNESS: T

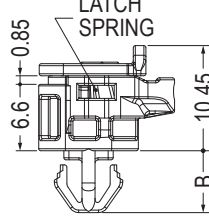
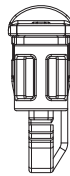

Part No.	B	T	Package
ULCOF-6SF	5.65	1.6	1000
ULCOF-6F	6.15	1.8, 2.2	
ULCOF-6LF	6.15	2.36~2.55	

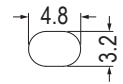
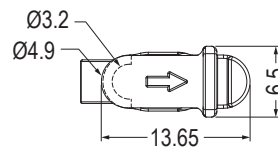
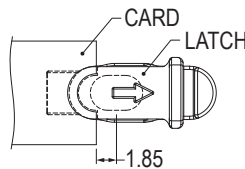
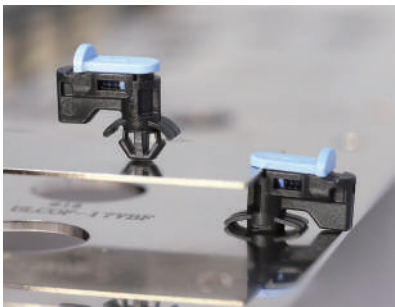

MOUNTING HOLE THICKNESS 1.57

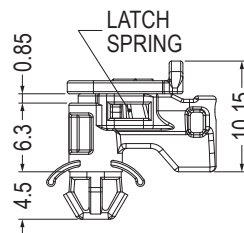
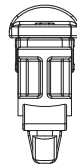

Part No.	Package
ULCOF-17F	1000

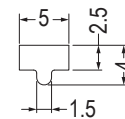
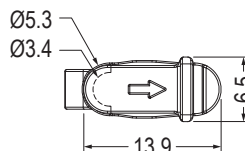
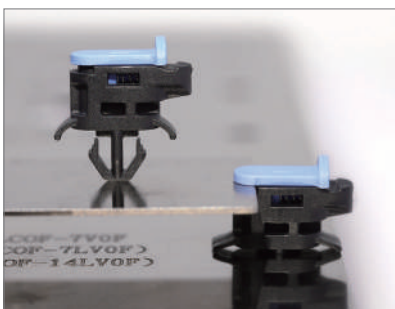

MOUNTING HOLE THICKNESS: T

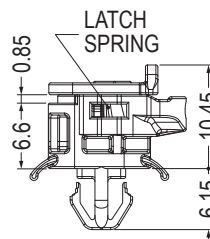

Part No.	T	Package
ULCOF-7F	1.93	1000
ULCOF-7LF	2.36~2.55	

PC板間隔柱 SPACER SUPPORT

用途：適用NGFF卡於機板上，免工具，易拆卸。

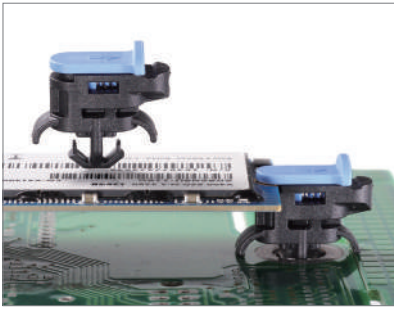

- Latch Base Material: Nylon 66 (UL)
- Latch Cover Material: Nylon 66 (UL)+GF
- Latch Spring Material: SWP Nickel Plated
- Flame Class: 94V-0
- Latch Base Color: Black
- Latch Cover Color: Blue
- Unit: mm
- Patented (專利品)

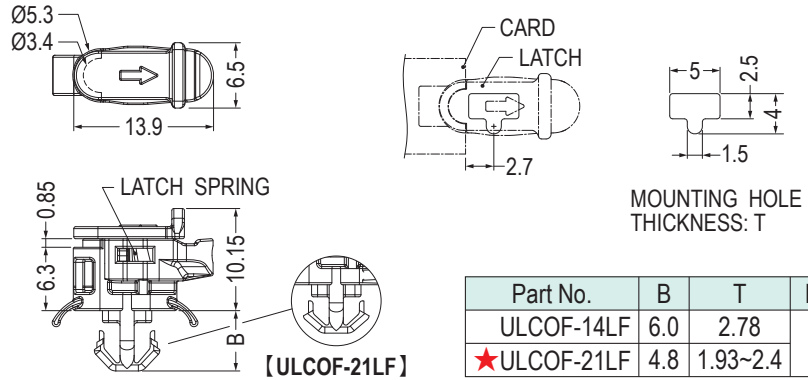

- Material: Nylon 66 (UL)
- Body Flame Class: 94V-2
- Latch Flame Class: 94V-0
- Body Color: Black
- Latch Color: Blue
- Unit: mm
- Patented (專利品)

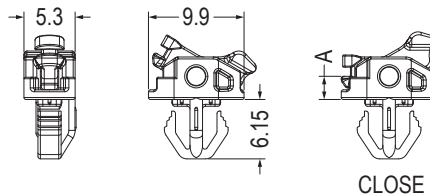
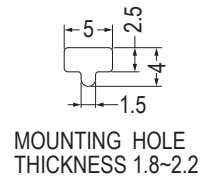
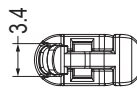

Part No.	A	Package
ULCOI-2.4F	2.4	1000
ULCOI-4F	4.0	
ULCOI-6.6F	6.6	



使用說明
Installation Step

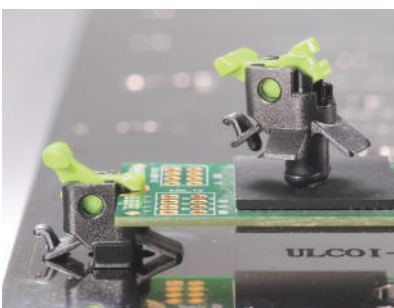

- Body Material: Nylon 66 (UL)
- Latch Material: Nylon 66 (UL)+GF
- Body Flame Class: 94V-2
- Latch Flame Class: 94V-0
- Body Color: Black
- Latch Color: Blue/Green
- Unit: mm
- Patented (專利品)

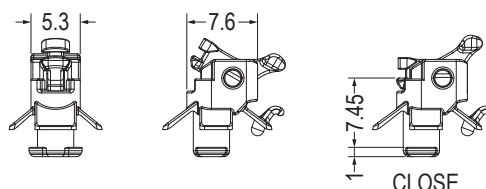
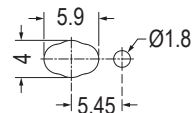
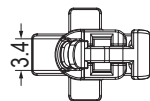

Part No.	Package
ULCOI-3F	1000

PC板間隔柱 SPACER SUPPORT

用途：適用NGFF卡於機板上，免工具，易拆卸。

1

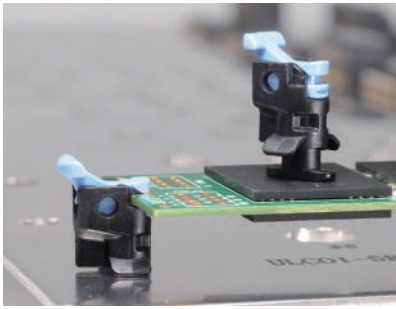

- Body Material: Nylon 66 (UL)
- Latch Material: Nylon 66 (UL)+GF
- Body Flame Class: 94V-2
- Latch Flame Class: 94V-0
- Body Color: Black
- Latch Color: Blue
- Unit: mm
- Patented (專利品)

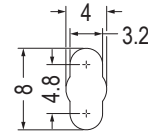
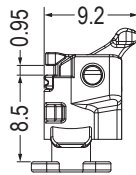
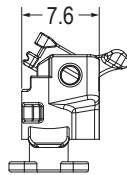
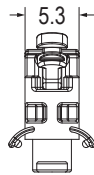
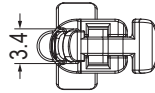
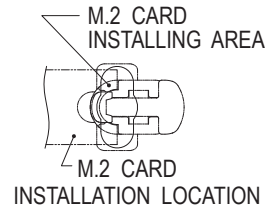

MOUNTING HOLE THICKNESS 1.9



Part No.	Package
ULCOI-5F	1000

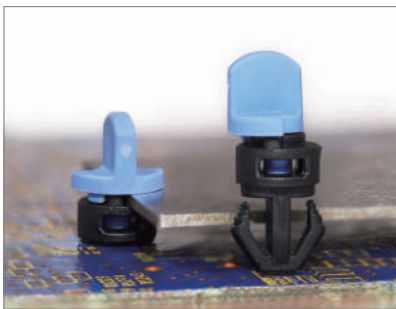

- Material: Nylon 66 (UL)
- Flame Class: 94V-0
- Latch Base Color: Black
- Latch Turn Handle Color: Blue
- Unit: mm
- Patented (專利品)

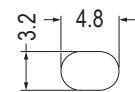
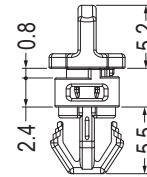
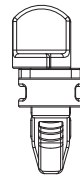
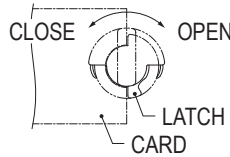
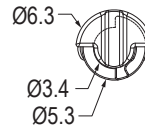

MOUNTING HOLE THICKNESS 1.6-2.1

Part No.	Package
ULCON-1F	1000



使用說明
Installation Step

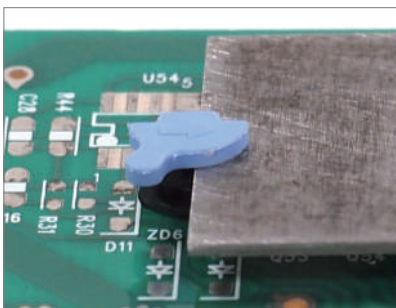

- Material: Nylon 66 (UL)
- Flame Class: 94V-0
- Latch Base Color: Black
- Latch Turn Handle Color: Blue
- Unit: mm
- Patented (專利品)

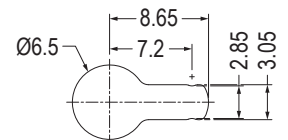
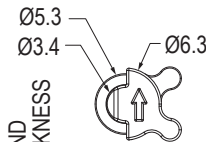

RECOMMEND MOUNTING HOLE
RECOMMEND THICKNESS 1.6

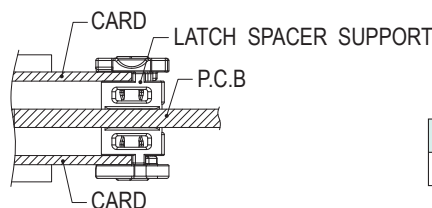
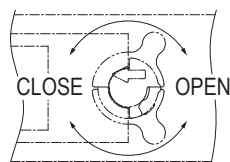
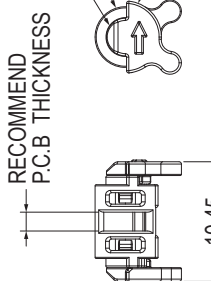
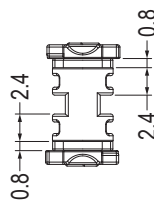

Part No.	Package
ULCON-3F	1000



使用說明
Installation Step

PC板間隔柱 SPACER SUPPORT

用途：適用NGFF卡於機板上，免工具，易拆卸。

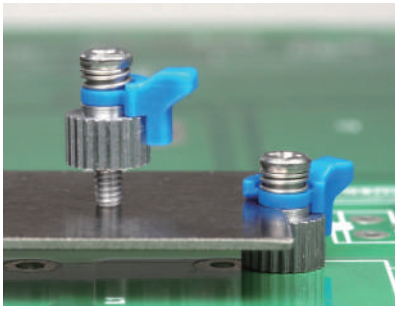

- Metal Material: Steel
- Insulator Material: POM
- Insulator Color: Blue
- Unit: mm
- Patented (專利品)

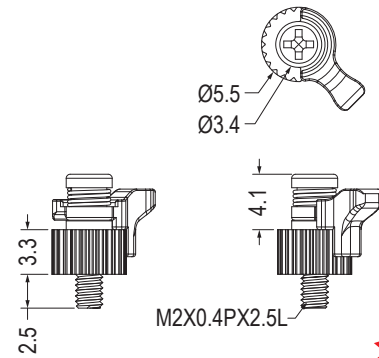
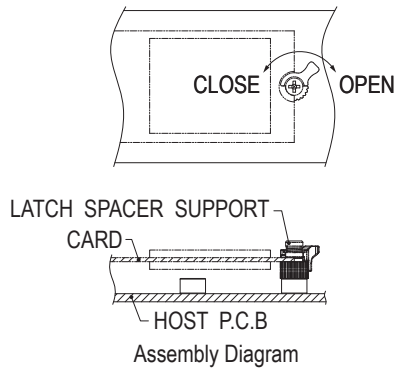

NEW

Part No.	Package
ULF-1(BU)F	1000

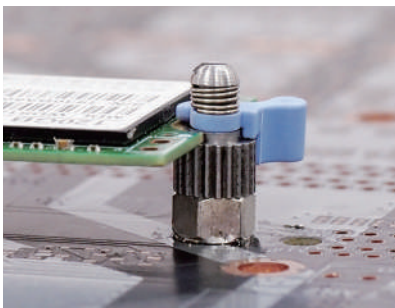

- Metal Material: Steel
- Insulator Material: Nylon 66 (UL)+GF
- Flame Class: 94V-0
- Insulator Color: Blue
- Unit: mm
- Patented (專利品)

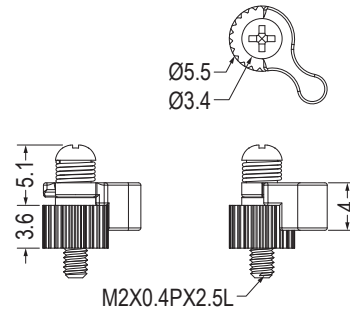
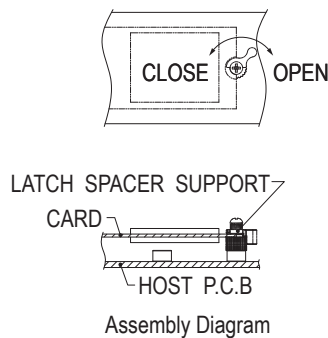

NEW

Part No.	Package
ULF-3.6(BU)F	1000



使用說明
Installation Step

固定扣 WIFI LOCK

用途：用於NGFF卡之絕緣與保護。

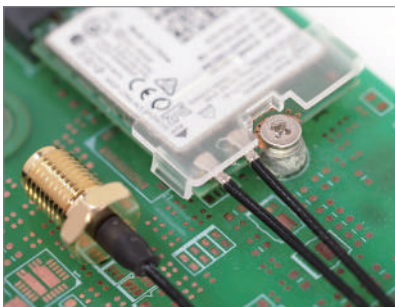

- Material: Nylon 66 (UL)/PC (UL)
- Flame Class: 94V-2
- Color: Black/Transparent
- Unit: mm

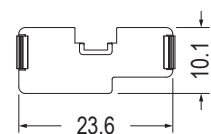
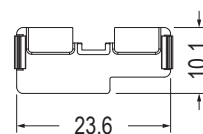
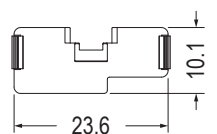
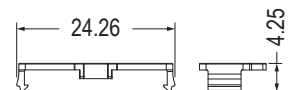
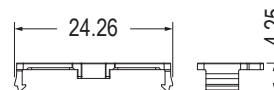
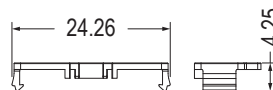

Part No.	Package
UNCV-1	1000

Part No.	Package
UNCV-2	1000

Part No.	Package
UNCV-3	1000

間隔柱 SPACER SUPPORT

用途：做為PC板與機板間之固定，需配合M3螺絲使用。



- Material: ABS (UL)
- Flame Class: 94HB
- Color: Natural
- Unit: mm

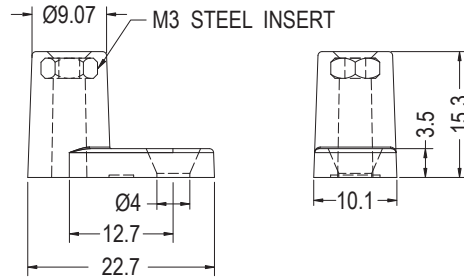

Part No.	Package
LLCB3-15	1000

PC板間隔柱 SPACER SUPPORT

用途：用於PC板與機板間之固定。



- Material: Nylon 66 (UL)
- Flame Class: 94V-2/94V-0
- Color: Natural/Black
- Unit: mm

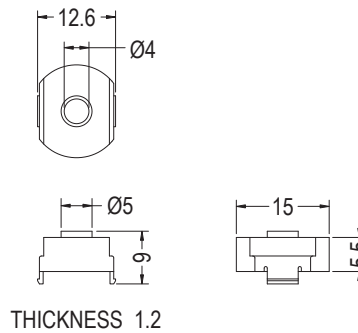

Part No.	Package
DDMC-5.5	1000

圓體間隔柱 ROUND SPACER

用途：用於零件之間隔與固定。



- Material: Nylon 66 (UL)
- Flame Class: 94V-2
- Color: Black
- Unit: mm

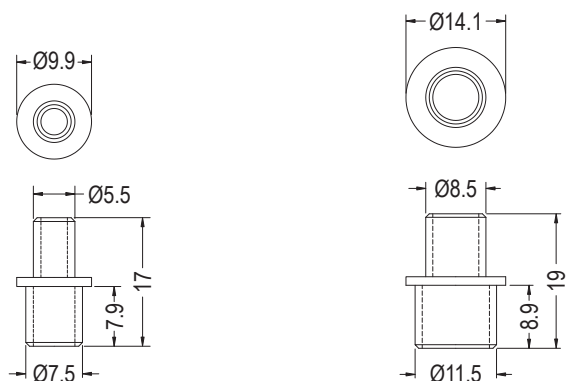

Part No.	Package
BPLT-9	1000

Part No.	Package
BPLT-13	1000