

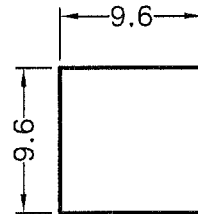

DIM.	TOL
L≤10	±0.2
10<L≤30	±0.3
30<L≤50	±0.5
50<L≤100	±0.7
100<L≤250	±1.2
ABOVE 250	±1.5

REVISIONS			
REV	DESCRIPTION	DATE	BY

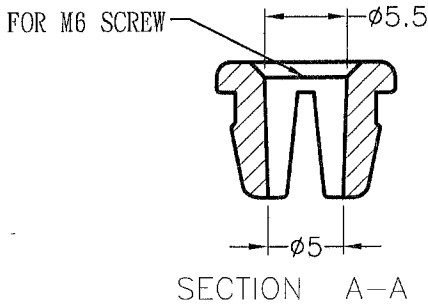
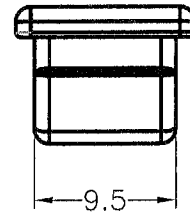
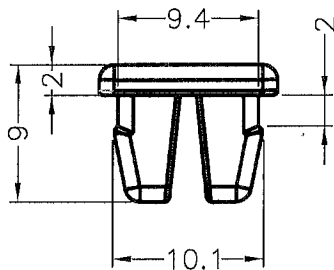
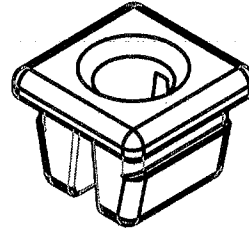
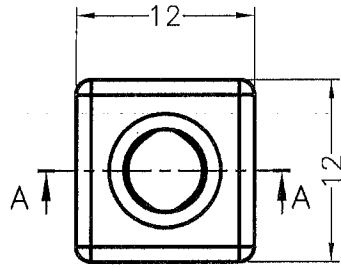

MOUNTING HOLE
CHASSIS THICKNESS 1.5mm

PART NO.	MATERIAL	COLOR
ESS6-2.5V0	NYLON 66 UL94V-0	NATURAL(WHITE)
ESS6-2.5	NYLON 66 UL94V-2	NATURAL

 <p>康揚企業股份有限公司 KANG YANG HARDWARE ENTERPRISE CO., LTD. 康揚塑膠(東莞)有限公司 KANG YANG PLASTIC(DONG GUAN) CO., LTD. 康哲電腦配件(吳江)有限公司 KANG CHE COMPUTER COMPONENTS(WUJIANG) CO., LTD.</p>	TITLE SPACER SUPPORT		SPEC. DWG.	
	MATERIAL SEE ABOVE		DATE	2013.03.28
	FINISH		DRAWN	T.C
	COLOR SEE ABOVE		CHECK	
PART NUMBER SEE ABOVE	DRAWING NUMBER ESS6-2.5		UNLESS OTHERWISE SPECIFIED TOLERANCE SEE ABOVE	
SIZE A4	SCALE 2:1	UNIT mm	REV C	APPROVED 