

1

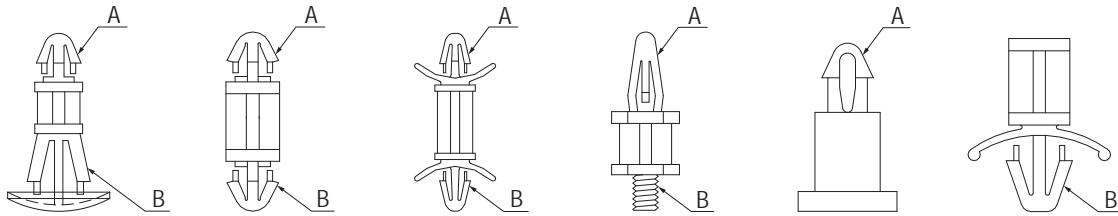

- PCB間隔柱
PCB Spacer
- M.2間隔柱
M.2 SSD Spacer
- 導電間隔柱
Conductive Spacer
- Wi-Fi固定扣
Wi-Fi Lock
- PCB固定座
PCB Mounting Block
- PCB固定扣
PCB Hinge & Bracket
- 導光板間隔柱
Pillar Support
- 圓體間隔柱
Round Spacer
- 螺柱
Standoff





1

Part No.	A	B	Page	Note
MCIA-		3.2x4.8	1-59	橢圓孔
SOR-3		3.2x6.0	1-73	M2.5 or M2.6 Screw
TCBE-		4.0x5.41	1-60	
KVLMMA-10		5.5x7.1	1-58	
KVLM3-		5.5x7.1	1-59	M3x0.5P
KVLM4-10		5.5x7.1	1-59	M4x0.7P
PAA-11		6.0x7.0	1-68	
LJ-4		Ø2.5	1-69	
LBS-		Ø3.0	1-46	
MSA-		Ø3.0	1-48	
TCBA-		Ø3.0	1-51	
LIO-		Ø3.0	1-69	
LIO-8		Ø3.0	1-69	
DCCB-4.1		Ø3.0~Ø3.18	1-51	
MSPE-7		Ø3.2	1-28	
LCUA-11		Ø3.4	1-84	
EDC-		Ø3.5	1-2	
LASE-		Ø3.5	1-47	
LASH-22		Ø3.5	1-47	
LASJ-		Ø3.5	1-47	
SSUL-8		Ø3.5	1-73	
LIES-1		Ø3.8	1-69	
RAMA-		Ø4.0	1-1	
RAMC-		Ø4.0	1-2	
LASB-3.7		Ø4.0	1-46	
LASF-18		Ø4.0	1-48	
TCBC-		Ø4.0	1-59	
TCBH-17F		Ø4.0	1-60	
SOR-2		Ø4.0	1-73	
TCEB3-		Ø4.1	1-65	M3x0.5P
TCEB4-		Ø4.1	1-65	M4x0.7P
TCEB632-		Ø4.1	1-65	6-32 UNC
LCU-18		Ø4.3	1-88	
LASD-8.3		Ø4.5	1-46	
RAD-		Ø4.8	1-1	
RAMD-15.5		Ø4.8	1-3	
LCDS3-		Ø4.8	1-45	M3x0.5P
LCDS4-		Ø4.8	1-46	M4x0.7P
LAS-		Ø4.8	1-47	
LASL-4.8		Ø4.8	1-47	
LASY-		Ø4.8	1-47	
ULCF-		Ø4.8	1-76	
WLCF-		Ø4.8	1-76	
ULCBB-		Ø4.8	1-84	
LASA-9.5		Ø4.8~Ø5.0	1-47	
TCBD-4.8		Ø4.8~Ø5.0	1-60	
CUS-5		Ø5.0	1-72	
RAM-		Ø5.5	1-1	
RAM-13.5L		Ø5.5	1-1	
RAML-		Ø5.5	1-1	
RAS-		Ø5.5	1-2	
SOR-1		Ø5.5	1-73	
RAMB-9		Ø5.6	1-3	
LDD-		Ø6.0	1-69	

Part No.	A	B	Page	Note
MCSH-7.2	2.0x3.0		1-55	
KVD-	4.0x5.5	5.0x6.5	1-20	
MASD-	Ø1.5		1-48	
MASS-	Ø1.5		1-48	
MASSD-	Ø1.5	Ø1.5	1-13	
MAEB-3.2	Ø1.5	Ø3.0	1-19	
LCMB-8	Ø1.5	Ø3.0	1-20	
MADSA-3	Ø1.6	Ø1.6	1-13	
MADSB-3	Ø1.6	Ø1.6	1-13	
MADS-	Ø1.6	Ø2.0	1-13	
MAS-9	Ø1.6	Ø2.0	1-13	
MAD1.7-9.8	Ø1.7	Ø1.7	1-13	
MAL-8	Ø2.0		1-48	
MASL-5.4	Ø2.0		1-48	
MAST-	Ø2.0		1-48	
MA-	Ø2.0		1-49	
MAB-4	Ø2.0		1-49	
MABA-2.6	Ø2.0		1-49	
MA-XXDL	Ø2.0		1-49	
MS-	Ø2.0		1-52	
ISS-	Ø2.0		1-77	Double Adhesive Tape
MAD1-	Ø2.0	Ø2.0	1-13	
MAD1.2-12.9	Ø2.0	Ø2.0	1-13	
MAD-	Ø2.0	Ø2.0	1-14	
MAD1.2-	Ø2.0	Ø2.0	1-14	
MADB-	Ø2.0	Ø2.0	1-14	
MADX-9.5	Ø2.0	Ø2.0	1-14	
MADG-5.4	Ø2.0	Ø2.0	1-36	
MAMDA-	Ø2.0	Ø2.5	1-15	
LCMA-	Ø2.0	Ø3.0~Ø3.2	1-40	
RCAB-	Ø2.0	Ø4.0	1-12	
PCLS-25	Ø2.2		1-52	
MAHA-7	Ø2.2	Ø2.2	1-15	
MSB-2.8	Ø2.3		1-52	
ULCBA-5	Ø2.35	Ø4.0	1-82	
ULCSD-5	Ø2.4	Ø2.8	1-82	
MAMS-	Ø2.5		1-49	
MAMS-7.5	Ø2.5		1-49	
MAM-	Ø2.5		1-50	
MSM-2.5	Ø2.5		1-52	
MAE2.5-6.5	Ø2.5		1-53	
MAE2.5-6.5T	Ø2.5		1-53	M2x0.4P
GSS-	Ø2.5		1-77	Double Adhesive Tape
ULCI-11	Ø2.5		1-80	
ULCIJ-4	Ø2.5		1-80	
SCBS632-	Ø2.5		1-126	6-32 UNC
MADA-18S	Ø2.5	Ø2.5	1-15	
MADAA-14	Ø2.5	Ø2.5	1-15	
MADJ-6	Ø2.5	Ø2.5	1-15	
MADA-	Ø2.5	Ø2.5	1-16	
MADA-XXL	Ø2.5	Ø2.5	1-16	
MADM-	Ø2.5	Ø2.5	1-16	
MAMDF-7	Ø2.5	Ø2.5	1-16	
MAMDL-9	Ø2.5	Ø2.5	1-16	

PCB間隔柱裝配孔快速索引 PCB SPACER MOUNTING HOLE INDEX

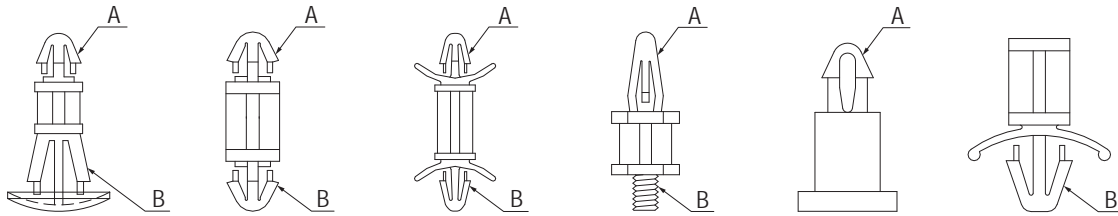

Part No.	A	B	Page	Note
MAC-	Ø2.5	Ø2.5	1-17	
MADE-2.8	Ø2.5	Ø2.5	1-17	
MAHC-14.3	Ø2.5	Ø2.5	1-17	
MADMK-5	Ø2.5	Ø2.5	1-20	
LCMC-7	Ø2.5	Ø3.0	1-20	
LCAB-	Ø2.5	Ø3.0	1-40	
LCMD-	Ø2.5	Ø3.0~Ø3.2	1-40	
RCAC-	Ø2.5	Ø4.0	1-12	
MAEE-4.5	Ø2.5	Ø4.0	1-19	
MAM-6.35L	Ø2.6		1-50	
MADAB-4.3	Ø2.6	Ø2.5	1-17	
MADM1-2.2	Ø2.6	Ø2.6	1-17	
MAHC-XXS	Ø2.6	Ø2.6	1-17	
MSPA-1.6	Ø2.6	Ø2.8	1-31	
LCUE-3.3	Ø2.6	Ø3.2	1-83	
MAMA-3.5	Ø2.7		1-50	
LCUAE-16LA	Ø2.8	3.2x4.8	1-87	
MSPA-6.3L	Ø2.8	Ø2.8	1-31	
SCBA-	Ø3.0		1-125	M3x0.5P
SCBD-8	Ø3.0		1-126	M3x0.5P
MSPA3-9.7	Ø3.0		1-126	M3x0.5P
DCC-	Ø3.0		1-50	
MAL-34	Ø3.0		1-50	
DCE-4	Ø3.0		1-51	
MAE-	Ø3.0		1-53	
MAE-XXT	Ø3.0		1-53	M3x0.5P
MAE-7-440	Ø3.0		1-54	
MAE-7-440T	Ø3.0		1-54	4-40 UNC
DCB-	Ø3.0		1-56	
DCBA-3.5	Ø3.0		1-56	
SS1-	Ø3.0		1-73	M2 Screw
SS3-7(1.3)	Ø3.0		1-73	M2 Screw
BSS-	Ø3.0		1-77	Double Adhesive Tape
CSS-	Ø3.0		1-78	Double Adhesive Tape
CSSA-2	Ø3.0		1-78	Double Adhesive Tape
LCUAC-7	Ø3.0	3.2x4.8	1-86	
LCUAE-12	Ø3.0	3.2x4.8	1-87	橢圓孔
MADL-27.8	Ø3.0	Ø3.0	1-18	
MAMDC-12	Ø3.0	Ø3.0	1-18	
MSPC3-	Ø3.0	Ø3.0	1-21	
MSPC3-3.2L	Ø3.0	Ø3.0	1-21	
MSPF3-	Ø3.0	Ø3.0	1-21	
SSDU1-3.5	Ø3.0	Ø3.0	1-28	
LCJ-	Ø3.0	Ø3.0	1-29	
LCV-	Ø3.0	Ø3.0	1-29	
LCVA-	Ø3.0	Ø3.0	1-29	
LCVU-	Ø3.0	Ø3.0	1-29	
LMSA-6	Ø3.0	Ø3.0	1-31	
CBSA-13	Ø3.0	Ø3.0	1-33	
LCF-	Ø3.0	Ø3.0	1-33	
LCGA-	Ø3.0	Ø3.0	1-33	
MADP-17.5	Ø3.0	Ø3.0	1-36	
LCA-	Ø3.0	Ø3.0	1-37	
LCG-	Ø3.0	Ø3.0	1-41	

Part No.	A	B	Page	Note
LCFO-	Ø3.0	Ø3.5	1-33	
RCI-2.6	Ø3.0	Ø4.0	1-3	
RCO-	Ø3.0	Ø4.0	1-3	
RCA-	Ø3.0	Ø4.0	1-4	
MAEA-3.5	Ø3.0	Ø4.0	1-19	
LCX-31	Ø3.0	Ø4.0	1-29	
MADP-20S	Ø3.0	Ø4.0	1-36	
LCH-	Ø3.0	Ø4.0	1-37	
LCH-XXS	Ø3.0	Ø4.0	1-37	
RCC-	Ø3.0	Ø4.8	1-4	
LCBT-	Ø3.0	Ø4.8	1-41	
KLCBS-	Ø3.0	Ø4.8	1-42	
LCBUA-13.9	Ø3.0	Ø4.8~Ø5.0	1-41	
RCG-	Ø3.0	Ø5.5	1-5	
LCHA-2.3	Ø3.0	3.0x4.0	1-37	橢圓孔
DCBA-8	Ø3.1		1-56	
LCUAC-11	Ø3.1	3.2x4.8	1-86	橢圓孔
LCUAE-8	Ø3.1	3.2x4.8	1-86	橢圓孔
MADD-2	Ø3.1	Ø3.0	1-18	
JSS-	Ø3.2		1-78	Double Adhesive Tape
SCB3-	Ø3.2		1-127	M3x0.5P
ULCSE-	Ø3.2	3.2x4.8	1-83	橢圓孔
LCUAC-	Ø3.2	3.2x4.8	1-85	橢圓孔
LCUAC-	Ø3.2	3.2x4.8	1-86	橢圓孔
LCPL-6.4	Ø3.2	Ø2.0	1-32	
LCSE-	Ø3.2	Ø3.0~Ø3.2	1-43	
MADN-24	Ø3.2	Ø3.2	1-18	
MSPB3.2-6.4	Ø3.2	Ø3.2	1-21	
MSPP-	Ø3.2	Ø3.2	1-21	
DMSB-	Ø3.2	Ø3.2	1-23	
DMSS-	Ø3.2	Ø3.2	1-23	
MSPS3S-7.5	Ø3.2	Ø3.2	1-23	
MSP3-	Ø3.2	Ø3.2	1-24	
MSPL-11	Ø3.2	Ø3.2	1-24	
MSPS3-	Ø3.2	Ø3.2	1-24	
MSPMA-12	Ø3.2	Ø3.2	1-25	
LCJ-15	Ø3.2	Ø3.2	1-29	
LMSE-4.8	Ø3.2	Ø3.2	1-31	
LMSB-4	Ø3.2	Ø3.2	1-32	
LMSP-	Ø3.2	Ø3.2	1-32	
RCMB-2.8	Ø3.2	Ø4.0	1-5	
LCUAD-1	Ø3.2	Ø4.1	1-84	
ULCSF-	Ø3.2	Ø4.2	1-82	
RCBS-	Ø3.2	Ø4.8	1-8	
RRC-3.2	Ø3.2	Ø4.8	1-8	
RCV-11.1	Ø3.2	Ø4.8	1-8	
RCW-	Ø3.2	Ø4.8	1-8	
ULCD-7.8	Ø3.3		1-80	M3x0.5P
MSPD-	Ø3.3	3.2x4.8	1-25	橢圓孔
MSPN-	Ø3.3	3.2x4.8	1-25	橢圓孔
MSPQ-16	Ø3.3	3.2x4.8	1-26	橢圓孔
LMSD-	Ø3.3	3.2x4.8	1-45	橢圓孔
ULCH-2	Ø3.3	3.2x4.8	1-80	M2.5 Screw
ULCSA-	Ø3.3	3.2x4.8	1-81	

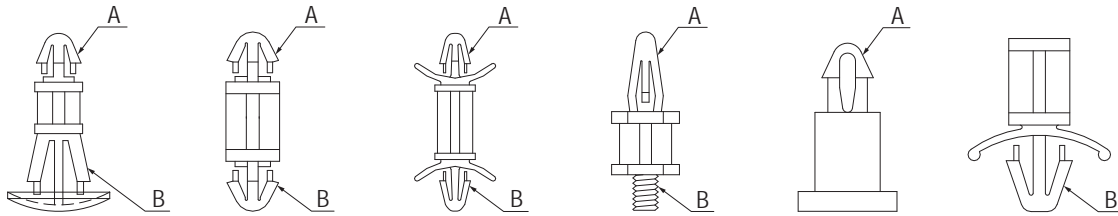

1

Part No.	A	B	Page	Note
ULCSA-28.8S	Ø3.3	3.2x4.8	1-82	
KEMS-11.3	Ø3.3	5.5x5.5	1-88	
MSPB-	Ø3.3	Ø3.2	1-22	
MSPH-7.5	Ø3.3	Ø3.2	1-26	
MSPCA-16	Ø3.3	Ø3.3	1-22	
MSPCA3.3-	Ø3.3	Ø3.3	1-22	
MSPF3.3-	Ø3.3	Ø3.3	1-22	
MSPF3.3-8L	Ø3.3	Ø3.3	1-22	
DMSC-4.5	Ø3.3	Ø3.3	1-25	
LCOA-28.8	Ø3.3	Ø3.3	1-32	
SCB3-38	Ø3.4		1-127	M3x0.5P
LCIA-3.5	Ø3.4	Ø3.7	1-30	
RCCA-8	Ø3.4	Ø4.8	1-5	
ULCBA-7.8	Ø3.4	Ø4.8	1-83	
SCBB-3	Ø3.5		1-126	M3x0.5P
SCBC-	Ø3.5		1-126	M3x0.5P
MCM-	Ø3.5		1-51	
PDC-	Ø3.5		1-56	
MCN-10	Ø3.5		1-57	
PDC-	Ø3.5		1-57	
PDC-XXD	Ø3.5		1-57	
FSL-25	Ø3.5		1-78	Double Adhesive Tape
FSS-	Ø3.5		1-78	Double Adhesive Tape
FSSA-15	Ø3.5		1-78	
LCPLB-11	Ø3.5	Ø2.6	1-32	
MAF-	Ø3.5	Ø3.5	1-18	
MAD3.5-12	Ø3.5	Ø3.5	1-19	
MAFA-6	Ø3.5	Ø3.5	1-19	
MDLS-4.5	Ø3.5	Ø3.5	1-19	
MAMDD-6	Ø3.5	Ø3.5	1-20	
LCI-	Ø3.5	Ø3.5	1-29	
LDE-33	Ø3.5	Ø3.5	1-30	
CBCS-14	Ø3.5	Ø3.5	1-34	
LCD-	Ø3.5	Ø3.5	1-34	
LCO-	Ø3.5	Ø3.5	1-34	
CBSS-	Ø3.5	Ø3.5	1-37	
LCPA-8.2	Ø3.5	Ø4.0	1-44	
LCBU-	Ø3.5	Ø4.8	1-41	
KLCBM-	Ø3.5	Ø4.8	1-42	
RCT-	Ø3.5	Ø4.8~Ø5.0	1-10	
RCH-	Ø3.5	Ø5.5	1-5	
RCTA-4.5	Ø3.5	Ø5.5	1-10	
DCCA-4.3	Ø3.7		1-51	
UCBS-5A	Ø3.8	Ø4.8	1-44	
MSMA-3.5	Ø3.9		1-52	
MSP-15.9S	Ø3.9	Ø3.9	1-26	
MSPV-3	Ø3.9	Ø3.9	1-27	
MSPY-12.7	Ø3.96	Ø3.96	1-27	
MSPG3-	Ø3.9-Ø4.0		1-127	M3x0.5P
MSPG4-	Ø3.9-Ø4.0		1-127	M4x0.7P
MSPS-	Ø3.9-Ø4.0		1-127	6-32 UNC
MSPS-	Ø4.0		1-127	6-32 UNC
SCB-	Ø4.0		1-128	6-32 UNC
SCB-6SM3	Ø4.0		1-128	M3x0.5P

Part No.	A	B	Page	Note
SCB4-	Ø4.0		1-128	M4x0.7P
SCB832-	Ø4.0		1-128	8-32 UNC
MCO-16	Ø4.0		1-51	
MAE43-	Ø4.0		1-54	M3x0.5P
MAE43-4.8LT	Ø4.0		1-54	
MAE43-XXT	Ø4.0		1-54	M3x0.5P
MAE4D-6	Ø4.0		1-54	
MAE4D-6T	Ø4.0		1-54	M3x0.5P
MAE4-	Ø4.0		1-55	
MAE4-XXT	Ø4.0		1-55	M4x0.7P
MCI-4.7	Ø4.0		1-55	
MC-	Ø4.0		1-57	
MC-	Ø4.0		1-58	
MCE-1.9	Ø4.0		1-58	
MCEA-1.9	Ø4.0		1-58	
MCH-	Ø4.0		1-58	
TCBS-	Ø4.0		1-62	M3 Screw
TCBS-18	Ø4.0		1-62	M3 Screw
TCBT-	Ø4.0		1-62	M3 Screw
TCBT-16	Ø4.0		1-62	4-40 UNC
TCBT-3.6	Ø4.0		1-62	
TCBT-7	Ø4.0		1-62	4-40 UNC
BS-	Ø4.0		1-63	
BS-10-1	Ø4.0		1-63	M3.5~M4 Screw
BS-20-1	Ø4.0		1-63	M3.5~M4 Screw
BS-35.7	Ø4.0		1-63	M3.5 Screw
MBS-	Ø4.0		1-63	
BSB-6	Ø4.0		1-64	
BSCL-9.5	Ø4.0		1-64	
SRLCB-	Ø4.0		1-64	
BSB632-15.9	Ø4.0		1-66	6-32 UNC
BSC632-	Ø4.0		1-66	6-32 UNC
BSCB-	Ø4.0		1-66	M3x0.5P
BSCB-20	Ø4.0		1-66	M3x0.5P
BSCB4-	Ø4.0		1-66	M4x0.7P
BSCM4-	Ø4.0		1-67	M4x0.7P
BSD632-	Ø4.0		1-67	6-32 UNC
BSDM4-	Ø4.0		1-67	M4x0.7P
SS2-	Ø4.0		1-74	M2.6 Screw
SS2-2.5U	Ø4.0		1-74	M2 Screw
ASS-	Ø4.0		1-79	Double Adhesive Tape
LCBL-8	Ø4.0		1-79	
ULCC-	Ø4.0		1-80	M3 Screw
ULCBM4-9.5	Ø4.0		1-81	M4x0.7P
LCBA-	Ø4.0	2.7x7.2	1-42	
ULCH-1	Ø4.0	4.0x6.8	1-81	
LCSI-10	Ø4.0	5.5x5.5	1-45	
KEML-	Ø4.0	5.5x5.5	1-88	
PCC-6	Ø4.0	6.0x7.0	1-68	
PCC-11	Ø4.0	6.0x7.0	1-68	
RCFA-7	Ø4.0	6.3x6.3	1-10	
KES-15	Ø4.0	6.5x7.0	1-84	
DMSP-	Ø4.0	Ø4.0	1-26	
DMSPS-	Ø4.0	Ø4.0	1-26	

PCB間隔柱裝配孔快速索引 PCB SPACER MOUNTING HOLE INDEX

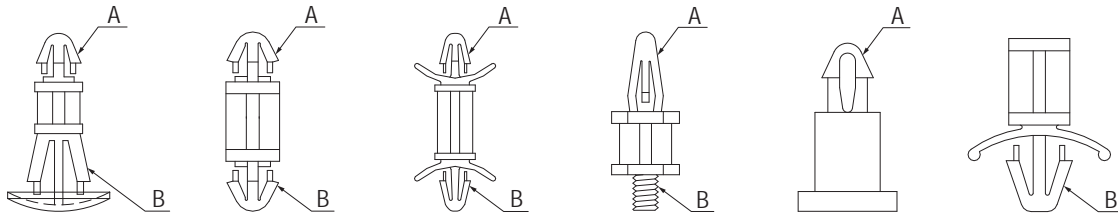

Part No.	A	B	Page	Note
MSP-	Ø4.0	Ø4.0	1-26	
MSP1-	Ø4.0	Ø4.0	1-27	
MSPM-	Ø4.0	Ø4.0	1-27	
SP1-4.8	Ø4.0	Ø4.0	1-27	
DMSA-9	Ø4.0	Ø4.0	1-28	
SSDUA-16.5	Ø4.0	Ø4.0	1-28	
LCK-1	Ø4.0	Ø4.0	1-30	
LCC-	Ø4.0	Ø4.0	1-31	
LCSF-15	Ø4.0	Ø4.0	1-33	
LCBJ-9	Ø4.0	Ø4.0	1-35	
LCFB-8	Ø4.0	Ø4.0	1-35	
LCTA-	Ø4.0	Ø4.0	1-35	
LCEO-	Ø4.0	Ø4.0	1-36	
CBLSS-	Ø4.0	Ø4.0	1-37	
CBSB-45	Ø4.0	Ø4.0	1-38	
LCL-3.2	Ø4.0	Ø4.0	1-38	
LCGB-17.5	Ø4.0	Ø4.0	1-41	
LCSJ-16	Ø4.0	Ø4.0	1-43	
WBHB-1.8	Ø4.0	Ø4.0	1-68	
ULCE-9	Ø4.0	Ø4.0	1-83	
MSPR-3	Ø4.0	Ø4.0	1-90	
LCT-9	Ø4.0	Ø4.5	1-35	
DRCB-18	Ø4.0	Ø4.5~Ø5.0	1-11	
LCSH-9.5	Ø4.0	Ø4.7	1-43	
LCSA-	Ø4.0	Ø4.75	1-43	
RCD-	Ø4.0	Ø4.8	1-6	
MSPK45-	Ø4.0	Ø4.8	1-27	
LCBM-	Ø4.0	Ø4.8	1-31	
LCBD-12.7	Ø4.0	Ø4.8	1-35	
LCBZ-	Ø4.0	Ø4.8	1-36	
CBS-	Ø4.0	Ø4.8	1-38	
LCB-	Ø4.0	Ø4.8	1-38	
LCBSA-	Ø4.0	Ø4.8	1-38	
LCBB-	Ø4.0	Ø4.8	1-39	
LCBS-	Ø4.0	Ø4.8	1-39	
VCBS-	Ø4.0	Ø4.8	1-39	
VCBSL-	Ø4.0	Ø4.8	1-39	
VCBA-14.4F	Ø4.0	Ø4.8	1-40	
KLCBL-	Ø4.0	Ø4.8	1-42	
LCBC-8	Ø4.0	Ø4.8	1-42	
HLCS-	Ø4.0	Ø4.8	1-43	
LCS-	Ø4.0	Ø4.8	1-43	
LCSD-	Ø4.0	Ø4.8	1-44	
LCSL-4.8	Ø4.0	Ø4.8	1-44	
LCSLR-9.5	Ø4.0	Ø4.8	1-44	
LCP-	Ø4.0	Ø4.8	1-44	
LCPD-	Ø4.0	Ø4.8	1-44	
LCY-4.8	Ø4.0	Ø4.8	1-44	
UCBS-	Ø4.0	Ø4.8	1-44	
ULCB-	Ø4.0	Ø4.8	1-85	
RCS-	Ø4.0	Ø5.0	1-6	
RCWA-	Ø4.0	Ø5.4	1-8	
PCBS-6.4	Ø4.0	Ø5.4	1-9	
RCJ-	Ø4.0	Ø5.4	1-11	

Part No.	A	B	Page	Note
RCTL-	Ø4.0	Ø5.4	1-11	
UCBSL-	Ø4.0	Ø5.4	1-45	
RCMA-3	Ø4.0	Ø5.5	1-5	
RCB-	Ø4.0	Ø5.5	1-6	
RCB-11.5	Ø4.0	Ø5.5	1-6	
RCBL-6	Ø4.0	Ø5.5	1-6	
RCI-5	Ø4.0	Ø5.5	1-6	
RCM-	Ø4.0	Ø5.5	1-7	
RCMD-6	Ø4.0	Ø5.5	1-7	
PCBS-	Ø4.0	Ø5.5	1-9	
PCBS-3	Ø4.0	Ø5.5	1-9	
PCBT-	Ø4.0	Ø5.5	1-9	
RCR-12.7	Ø4.0	Ø5.5	1-9	
RBS-	Ø4.0	Ø5.5	1-11	
RBT-	Ø4.0	Ø5.5	1-11	
RCF-	Ø4.0	Ø6.0	1-7	
PCBTA-4.8	Ø4.0	Ø6.0	1-9	
RCFL-	Ø4.0	Ø6.0	1-10	
ACBW-6.8	Ø4.0	Ø6.0	1-67	
ACBR-6	Ø4.0	Ø6.1~Ø6.4	1-60	
RCRA-9.5	Ø4.0	Ø6.35	1-9	
RCFB-10	Ø4.0	Ø6.5	1-10	
ACB-	Ø4.0	Ø6.5	1-61	
MCB-6	Ø4.0	Ø6.5	1-61	
RCQC-7	Ø4.0	Ø7.0	1-24	
WBHC-6.4	Ø4.0	Ø7.9	1-67	
WBH-	Ø4.0	Ø7.9	1-68	
SRLA-	Ø4.1	Ø4.75~Ø4.8	1-65	
BSB-8.5	Ø4.2		1-64	
TCBT-19	Ø4.5		1-62	M3 Screw
MTD-11	Ø4.5		1-63	
MBC-11	Ø4.5	Ø6.5	1-61	
MBD-10	Ø4.5~Ø4.8	Ø16.5	1-61	
LCBF-7.4	Ø4.75	Ø4.75	1-36	
MCL-	Ø4.8		1-58	
SS-	Ø4.8		1-73	M3 Screw
SSA-12.7	Ø4.8		1-74	M3 Screw
MSPK4.8-	Ø4.8	Ø4.8	1-28	
LCBY-	Ø4.8	Ø4.8	1-36	
LCBYR-4.8	Ø4.8	Ø4.8	1-36	
MAFB5-	Ø5.0	Ø5.0	1-19	
SSDU-	Ø5.2	Ø5.2	1-28	
RCWB-21	Ø5.3	Ø9.0	1-8	
SSA4-5.5	Ø5.8		1-74	M3.5 or M4 Screw
SSU4-	Ø5.9		1-74	M3.5 Screw
SS3.5-	Ø5.9		1-75	M3.5 or M4 Screw
SS4-	Ø5.9		1-75	M4 Screw
SSUA4-6.3L	Ø6.0		1-75	M4 Screw
RCBC-12	Ø6.2	Ø9.0	1-8	

PCB間隔柱 PCB SPACER

用途：一端固定於機板上，另一端支撐PC板，避免下陷造成短路，PC板免鑽孔。

- Material: Nylon 66 (UL)
- Flame Class: 94V-2/94V-0
- Color: Natural/Black
- Unit: mm

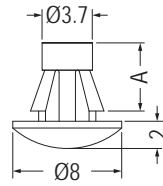
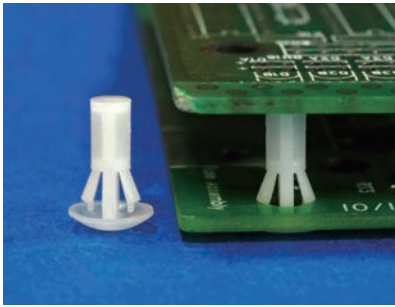

MOUNTING HOLE Ø4.0
THICKNESS 0.8-1.6

Part No.	A	Package
RAMA-3	3.2	1000
RAMA-4.5	4.5	
RAMA-5.5	5.5	

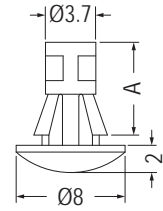

MOUNTING HOLE Ø4.0
THICKNESS 0.8-1.6

Part No.	A	Package
RAMA-6.4	6.4	1000
RAMA-7	7.0	
RAMA-7.5	7.5	
RAMA-9.5	9.5	
RAMA-11.1	11.1	
RAMA-12.7	12.7	

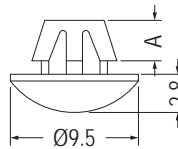
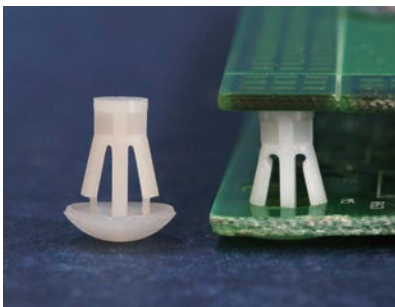

MOUNTING HOLE Ø4.8
THICKNESS 0.8-1.2

Part No.	A	Package
RAD-3	3.0	1000
RAD-4	4.0	

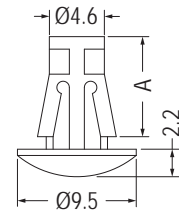

MOUNTING HOLE Ø4.8
THICKNESS 0.8-1.2

Part No.	A	Package
RAD-6	6.3	1000
RAD-8	8.0	
RAD-10	10.0	
RAD-11	11.0	

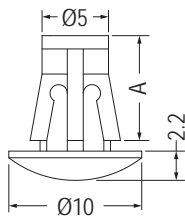

MOUNTING HOLE Ø5.5
THICKNESS 0.8-1.6

Part No.	A	Package
RAM-6	6.35	1000
RAM-7	7.0	
RAM-8	8.0	
RAM-8.5	8.5	
RAM-10	10.0	
RAM-12A	12.0	
RAM-12	12.7	
RAM-13.5	13.5	
RAM-14	14.0	
RAM-15	15.2	
RAM-16	15.9	
RAM-18	18.0	
RAM-19	19.0	
RAM-20	20.0	500
RAM-22	21.7	
RAM-24	24.0	
RAM-25	25.4	
RAM-30	30.0	

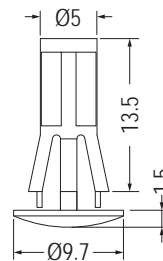

MOUNTING HOLE Ø5.5
THICKNESS 1.2-1.8

Part No.	Package
RAM-13.5L	1000

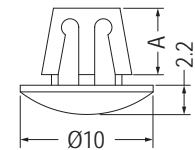

MOUNTING HOLE Ø5.5
THICKNESS 0.8-1.6

Part No.	A	Package
RAM-3	3.5	1000
RAM-5	5.0	

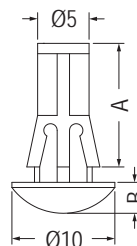

MOUNTING HOLE Ø5.5
THICKNESS 1.6-2.5

Part No.	A	B	Package
RAML-11	11.0	3.0	1000
RAML-12	12.0	2.45	

PCB間隔柱 PCB SPACER

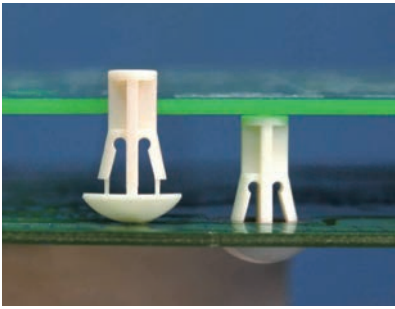

- Material: Nylon 66 (UL)
- Flame Class: 94V-2/94V-0
- Color: Natural/Black
- Unit: mm

用途：一端固定於機板上，另一端支撐PC板，避免下陷造成短路，PC板免鑽孔。

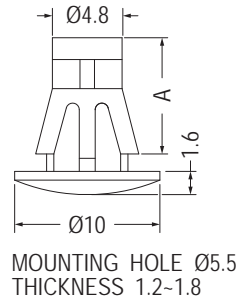

Part No.	A	Package
RAS-6	6.0	1000
RAS-8	8.0	
RAS-10	10.0	
RAS-12	12.0	
RAS-14	14.0	
RAS-18	18.0	
RAS-20	20.0	

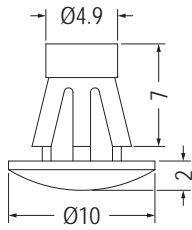

Part No.	Package
RAS-7	1000

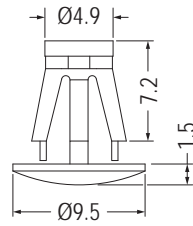

Part No.	Package
RAS-7.2	1000

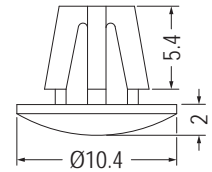

Part No.	Package
RAS-5	1000

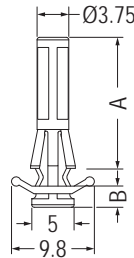
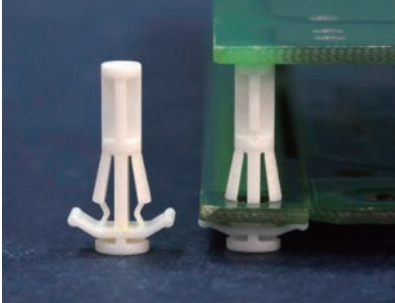

Part No.	A	B	Package
RAMC-12.5	12.5	2.5	1000
RAMC-15.5	15.5	2.5	
RAMC-18-4	18.0	4.0	
RAMC-18-8.5	18.0	8.5	
RAMC-19	19.0	2.5	
RAMC-24	24.0	2.5	

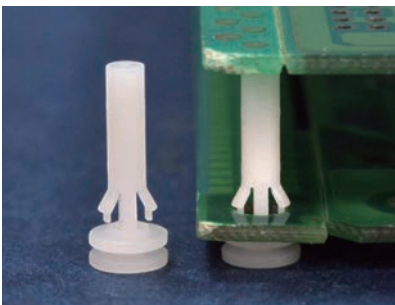

- Material: Nylon 66 (UL)
- Flame Class: 94V-2/94V-0
- Color: Natural/Black
- Unit: mm

用途：用於PCB之架高間隔，體積小，不佔空間。

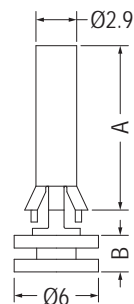

Part No.	A	B	Package
EDC-4	4.0	2.5	1000
EDC-5	5.0	2.5	
EDC-6	6.0	2.5	
EDC-7	7.0	2.5	
EDC-8	8.0	2.5	
EDC-9	9.0	2.5	
EDC-10	10.0	2.5	
EDC-11.4	11.4	2.5	
EDC-12.7	12.7	2.5	
EDC-13.5	13.5	2.5	
EDC-14.5	14.5	2.5	
EDC-15	15.0	2.5	
EDC-15-4	15.0	4.0	
EDC-15.9	15.9	2.5	

PCB間隔柱 PCB SPACER

用途：一端固定於機板上，另一端支撐PC板，避免下陷造成短路，PC板免鑽孔。

1

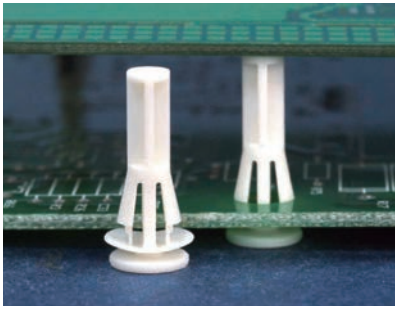

- Material: Nylon 66 (UL)
- Flame Class: 94V-2/94V-0
- Color: Natural/Black
- Unit: mm

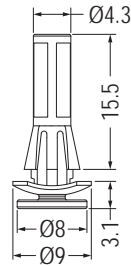

MOUNTING HOLE Ø4.8
THICKNESS 1.6

Part No.	Package
RAMD-15.5	1000

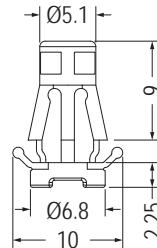
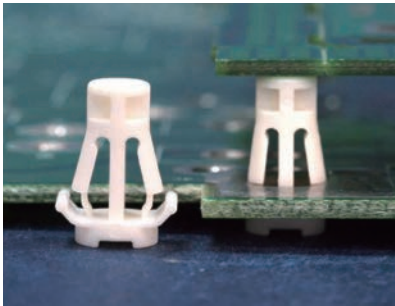

MOUNTING HOLE Ø5.6
THICKNESS 0.8-1.6

Part No.	Package
RAMB-9	1000

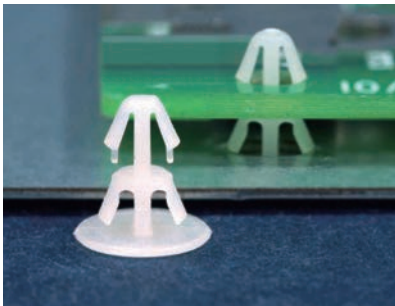

- Material: Nylon 66 (UL)
- Flame Class: 94V-2/94V-0
- Color: Natural/Black
- Unit: mm

用途：固定PC板於機板上，不會突出機板底部，外觀美麗。

MOUNTING HOLE Ø3.0
THICKNESS 1.6

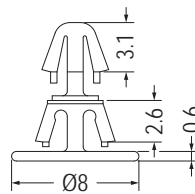

MOUNTING HOLE Ø4.0
THICKNESS 0.5

Part No.	Package
RCI-2.6	2000

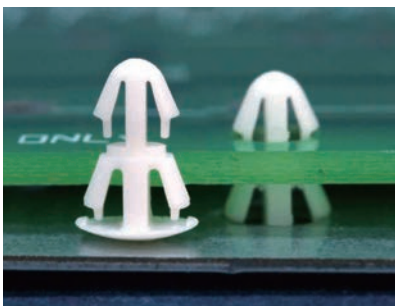

MOUNTING HOLE Ø3.0
THICKNESS 1.6

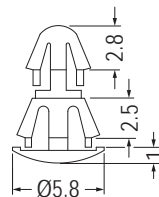

MOUNTING HOLE Ø4.0
THICKNESS 0.6-0.8

Part No.	Package
RCO-2.5	2000

MOUNTING HOLE Ø3.0
THICKNESS 1.6-2.0

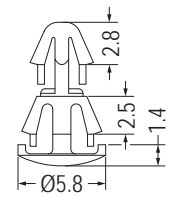

MOUNTING HOLE Ø4.0
THICKNESS 0.8-1.2

Part No.	Package
RCO-2.5L	2000

PCB間隔柱 PCB SPACER

用途：固定PC板於機板上，不會突出機板底部，外觀美麗。

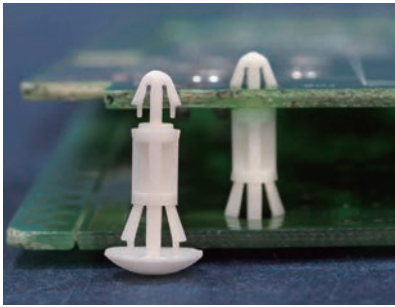

- Material: Nylon 66 (UL)
- Flame Class: 94V-2/94V-0
- Color: Natural/Black
- Unit: mm

MOUNTING HOLE Ø3.0
THICKNESS 1.6

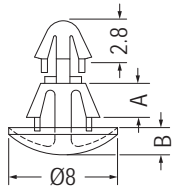

MOUNTING HOLE Ø4.0
THICKNESS 0.8-1.6

【 RCA-2.5, RCA-2.5U 】

MOUNTING HOLE Ø3.0
THICKNESS 1.6

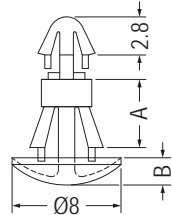

MOUNTING HOLE Ø4.0
THICKNESS 0.8-1.6

Part No.	A	B	Package
RCA-2.5U	2.5	1.8	2000
RCA-2.5	2.5	2.0	
RCA-3	3.2	2.0	
RCA-4	4.0	2.0	
RCA-4.5	4.5	2.0	
RCA-5	5.0	2.0	
RCA-5.5	5.5	2.0	

MOUNTING HOLE Ø3.0
THICKNESS: T

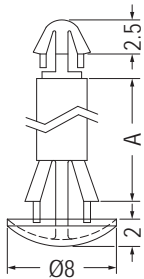

MOUNTING HOLE Ø4.0
THICKNESS 1.6-2.2

【 RCA-65.5 】

MOUNTING HOLE Ø3.0
THICKNESS: T

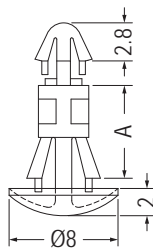

MOUNTING HOLE Ø4.0
THICKNESS 0.8-1.6

Part No.	A	T	Package
RCA-6	6.0	1.6	2000
RCA-6.4	6.4	1.6	
RCA-7	7.0	1.6	1000
RCA-7.5	7.5	1.6	
RCA-8	8.0	1.6	
RCA-8L	8.0	1.83	
RCA-9	9.0	1.6	
RCA-9.5	9.5	1.6	
RCA-10	10.0	1.6	
RCA-11.1	11.1	1.6	
RCA-12	12.0	1.6	
RCA-12.7	12.7	1.6	
RCA-14	14.0	1.6	
RCA-15.5	15.5	1.6	
RCA-16	16.0	1.6	
RCA-65.5	65.5	1.6	

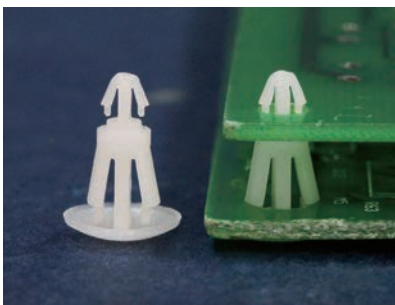

MOUNTING HOLE Ø3.0
THICKNESS 1.6

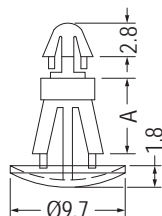

MOUNTING HOLE Ø4.8
THICKNESS 0.8-2.0

MOUNTING HOLE Ø3.0
THICKNESS 1.6

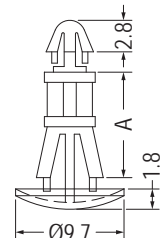

MOUNTING HOLE Ø4.8
THICKNESS 0.8-2.0

Part No.	A	Package
RCC-5	5.0	2000
RCC-6	6.3	
RCC-8	8.0	

Part No.	A	Package
RCC-10	10.0	1000
RCC-12	12.7	

PCB間隔柱 PCB SPACER

用途：固定PC板於機板上，不會突出機板底部，外觀美麗。

1

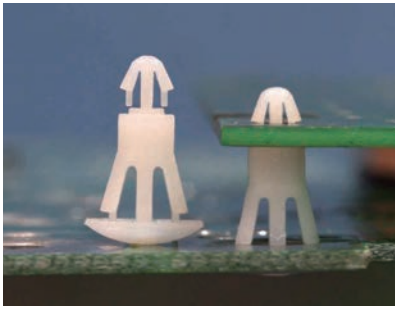

- Material: Nylon 66 (UL)
- Flame Class: 94V-2/94V-0
- Color: Natural/Black
- Unit: mm

MOUNTING HOLE Ø3.0
THICKNESS 1.2-1.7

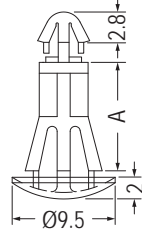

MOUNTING HOLE Ø5.5
THICKNESS 0.6-1.2

Part No.	A	Package
RCG-3.5	3.5	1000
RCG-5	4.8	
RCG-6.35	6.35	
RCG-7	7.0	
RCG-8	8.0	
RCG-10	10.0	
RCG-11	11.0	
RCG-12.7	12.7	
RCG-15.9	15.9	

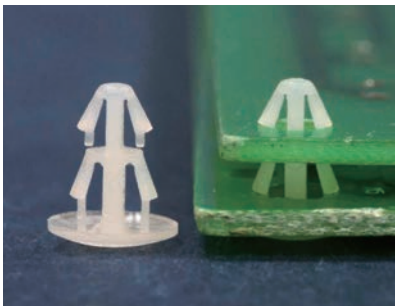

MOUNTING HOLE Ø3.2
THICKNESS 0.8-1.0

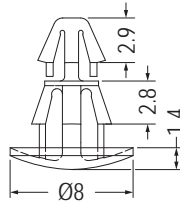

MOUNTING HOLE Ø4.0
THICKNESS 1.8

MOUNTING HOLE Ø3.2
THICKNESS 1.6

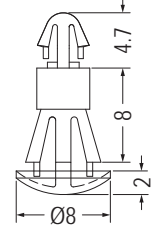

MOUNTING HOLE Ø4.8
THICKNESS 1.2-1.4

Part No.	Package
RCMB-2.8	1000

Part No.	Package
RCCA-8	1000

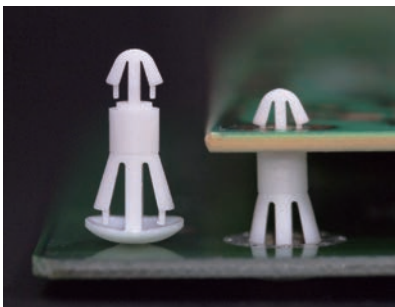

MOUNTING HOLE Ø3.5
THICKNESS 1.6

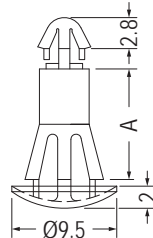

MOUNTING HOLE Ø5.5
THICKNESS 0.8-1.2

【 RCH-3.5-RCH-8 】

MOUNTING HOLE Ø3.5
THICKNESS 1.6

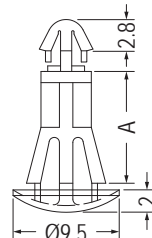

MOUNTING HOLE Ø5.5
THICKNESS 0.8-1.2

【 RCH-10-RCH-15.9 】

Part No.	A	Package
RCH-3.5	3.5	1000
RCH-5	4.8	
RCH-6.35	6.35	
RCH-7	7.0	
RCH-8	8.0	
RCH-10	10.0	
RCH-11	11.0	
RCH-12.7	12.7	
RCH-15.9	15.9	



MOUNTING HOLE Ø4.0
THICKNESS 1.2-1.6

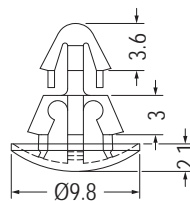

MOUNTING HOLE Ø5.5
THICKNESS 0.8-1.6

Part No.	Package
RCMA-3	1000

PCB間隔柱 PCB SPACER

用途：固定PC板於機板上，不會突出機板底部，外觀美麗。

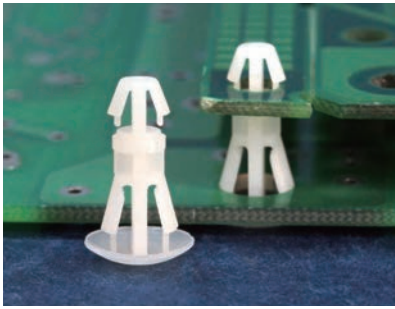

- Material: Nylon 66 (UL)
- Flame Class: 94V-2/94V-0
- Color: Natural/Black
- Unit: mm

MOUNTING HOLE Ø4.0
THICKNESS 1.7

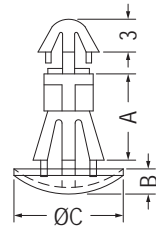

MOUNTING HOLE Ø5.0
THICKNESS 0.8-1.8

Part No.	A	B	C	Package
RCS-6	6.0	2.3	9.7	1000
RCS-13.8	13.8	2.2	10.0	
RCS-16	16.0	2.3	9.7	

MOUNTING HOLE Ø4.0
THICKNESS 1.0-1.8

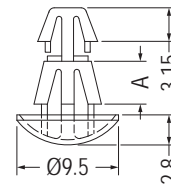

MOUNTING HOLE Ø4.8
THICKNESS 0.8-1.2

【 RCD-3, RCD-4 】

MOUNTING HOLE Ø4.0
THICKNESS 1.0-1.8

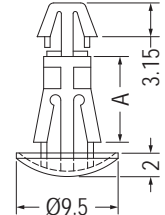

MOUNTING HOLE Ø4.8
THICKNESS 0.8-1.2

Part No.	A	Package
RCD-3	3.0	1000
RCD-4	4.0	
RCD-6	6.3	
RCD-8	8.0	
RCD-10	10.0	
RCD-11	11.0	

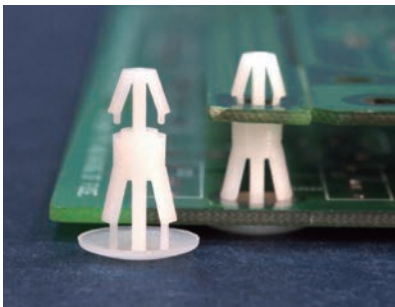

MOUNTING HOLE Ø4.0
THICKNESS 1.6

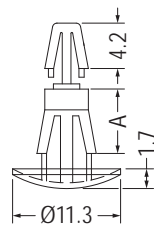

MOUNTING HOLE Ø5.5
THICKNESS 1.5-2.2

【 RCB-3-RCB-8 】

Part No.	A	Package
RCB-3	3.5	1000
RCB-5	5.0	
RCB-6	6.35	
RCB-8	8.0	
RCB-10	10.0	

MOUNTING HOLE Ø4.0
THICKNESS 1.6

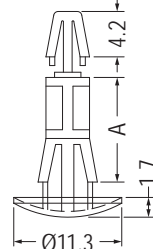

MOUNTING HOLE Ø5.5
THICKNESS 1.5-2.2

Part No.	A	Package
RCB-12	12.7	1000
RCB-15	15.9	
RCB-19	19.0	
RCB-25	25.4	500
RCB-35	35.5	

MOUNTING HOLE Ø4.0
THICKNESS 1.6

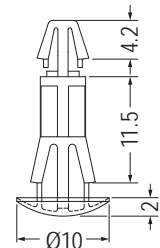

MOUNTING HOLE Ø5.5
THICKNESS 1.5-2.2

- Material: Nylon 46 (UL)
- Flame Class: 94V-2
- Color: Black

Part No.	Package
RCB-11.5	1000

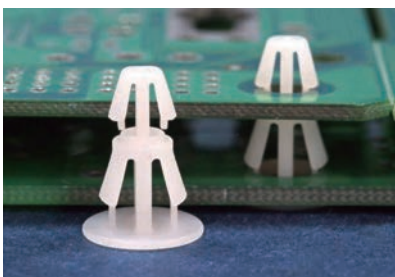

MOUNTING HOLE Ø4.0
THICKNESS 1.6

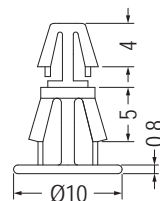

MOUNTING HOLE Ø5.5
THICKNESS 1.5-2.2

Part No.	Package
RCI-5	1000

MOUNTING HOLE Ø4.0
THICKNESS 1.6

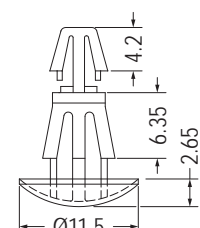

MOUNTING HOLE Ø5.5
THICKNESS 2.0-3.0

Part No.	Package
RCBL-6	1000

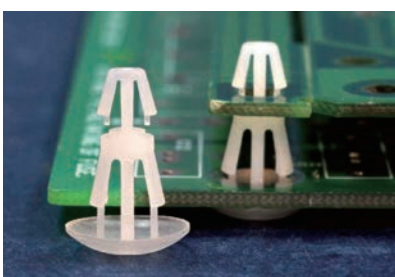

PCB間隔柱 PCB SPACER

用途：固定PC板於機板上，不會突出機板底部，外觀美麗。

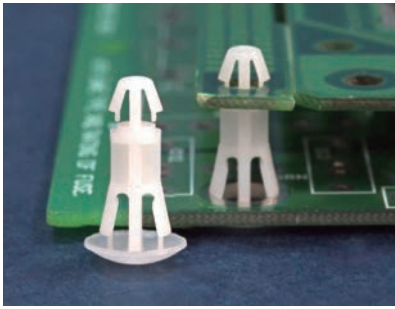

- Material: Nylon 66 (UL)
- Flame Class: 94V-2/94V-0
- Color: Natural/Black
- Unit: mm

MOUNTING HOLE Ø4.0
THICKNESS 1.2-1.7

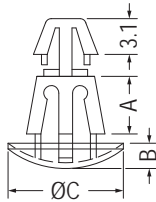

MOUNTING HOLE Ø5.5
THICKNESS 0.8-1.6

MOUNTING HOLE Ø4.0
THICKNESS 1.2-1.7

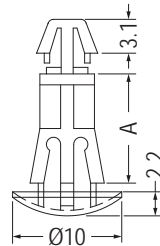

MOUNTING HOLE Ø5.5
THICKNESS: T

Part No.	A	B	C	Package
RCM-3	3.5	2.2	10.0	1000
RCM-5	5.0	2.2	10.0	
RCM-5SP	5.0	1.5	8.0	

Part No.	A	T	Package
RCM-6	6.35	0.8-1.6	1000
RCM-6L	6.35	1.6-2.0	
RCM-7	7.0	0.8-1.6	
RCM-8	8.0	0.8-1.6	
RCM-8.5	8.5	0.8-1.6	
RCM-10	10.0	0.8-1.6	
RCM-12A	12.0	0.8-1.6	
RCM-12	12.7	0.8-1.6	
RCM-13.5	13.5	0.8-1.6	
RCM-14	14.0	0.8-1.6	
RCM-15	15.2	0.8-1.6	
RCM-16	15.9	0.8-1.6	
RCM-18	18.0	0.8-1.6	
RCM-19	19.0	0.8-1.6	
RCM-20	20.0	0.8-1.6	
RCM-22	21.7	0.8-1.6	
RCM-24	24.0	0.8-1.6	
RCM-25	25.4	0.8-1.6	
RCM-30	30.0	0.8-1.6	

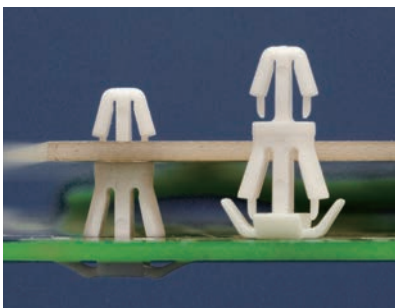

MOUNTING HOLE Ø4.0
THICKNESS 1.8

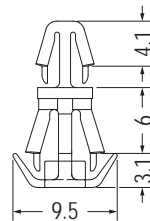

MOUNTING HOLE Ø5.5
THICKNESS 0.5-2.0

Part No.	Package
RCMD-6	1000

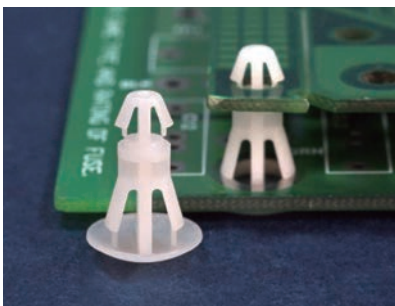

MOUNTING HOLE Ø4.0
THICKNESS 1.2-1.7

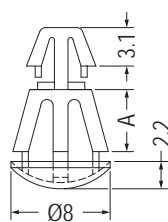

MOUNTING HOLE Ø6.0
THICKNESS 0.8-1.6

【RCF-5S】

MOUNTING HOLE Ø4.0
THICKNESS 1.2-1.7

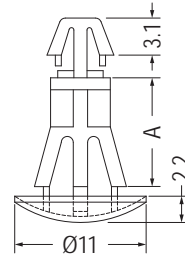

MOUNTING HOLE Ø6.0
THICKNESS 0.8-2.0

Part No.	A	Package
RCF-5	5.0	2000
RCF-5S	5.0	
RCF-6	6.35	1000
RCF-8	8.0	
RCF-10	10.0	
RCF-12	12.7	
RCF-15	15.9	

PCB間隔柱 PCB SPACER

用途：固定PC板於機板上，不會突出機板底部，外觀美麗。

- Material: Nylon 66 (UL)
- Flame Class: 94V-2/94V-0
- Color: Natural/Black
- Unit: mm

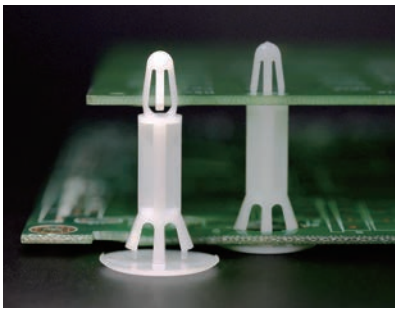
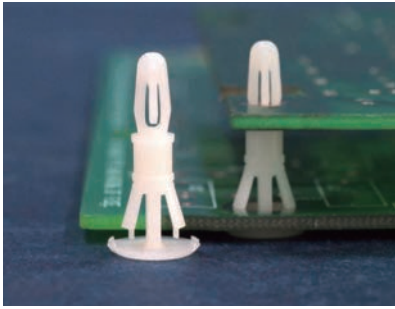
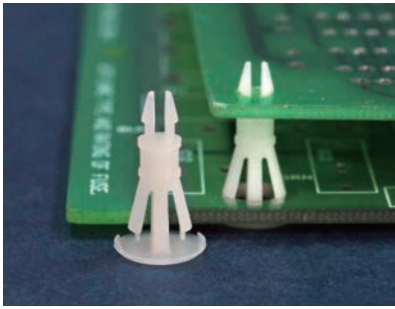

MOUNTING HOLE Ø3.2
THICKNESS 1.6

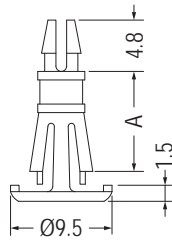

MOUNTING HOLE Ø4.8
THICKNESS 1.5-1.6

Part No.	A	Package
RCBS-6.5	6.5	1000
RCBS-9.5	9.5	
RCBS-12.7	12.7	

MOUNTING HOLE Ø6.2
THICKNESS 1.6

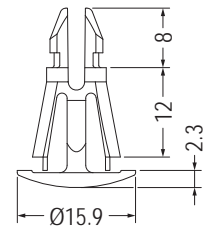

MOUNTING HOLE Ø9.0
THICKNESS 1.4

Part No.	Package
RCBC-12	1000

MOUNTING HOLE Ø3.2
THICKNESS 1.6

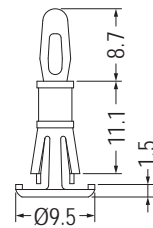

MOUNTING HOLE Ø4.8
THICKNESS 1.5-1.6

Part No.	Package
RCV-11.1	1000

MOUNTING HOLE Ø3.2
THICKNESS 1.7

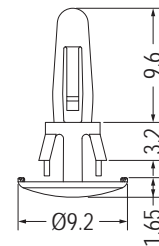

MOUNTING HOLE Ø4.8
THICKNESS 1.7

Part No.	Package
RCR-3.2	1000

MOUNTING HOLE Ø3.2
THICKNESS 1.2-1.7

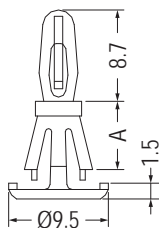

MOUNTING HOLE Ø4.8
THICKNESS 1.5-1.6

Part No.	A	Package
RCW-6.5	6.5	1000
RCW-7.9	7.9	
RCW-9.7	9.7	
RCW-11.1	11.1	
RCW-12.7	12.7	
RCW-14.3	14.3	
RCW-15.9	15.9	

MOUNTING HOLE Ø4.0
THICKNESS 1.6

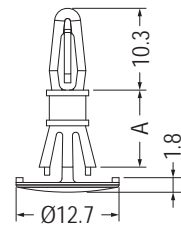

MOUNTING HOLE Ø5.4
THICKNESS 1.5-1.6

Part No.	A	Package
RCWA-6.4	6.4	1000
RCWA-9.5	9.5	
RCWA-12.7	12.7	
RCWA-15.9	15.9	
RCWA-19	19.1	
RCWA-22.2	22.2	
RCWA-25.4	25.4	

MOUNTING HOLE Ø5.3
THICKNESS 1.6

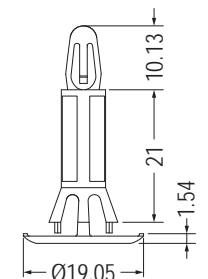

MOUNTING HOLE Ø9.0
THICKNESS 1.8

Part No.	Package
RCWB-21	1000

PCB間隔柱 PCB SPACER

用途：固定PC板於機板上，不會突出機板底部，外觀美麗。

- Material: Nylon 66 (UL)
- Flame Class: 94V-2/94V-0
- Color: Natural/Black
- Unit: mm

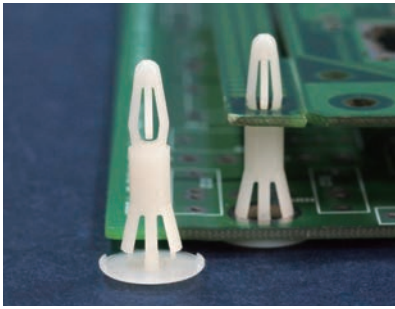

MOUNTING HOLE Ø4.0
THICKNESS 1.2-1.7

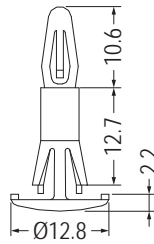

MOUNTING HOLE Ø5.5
THICKNESS 1.0-1.5

Part No.	Package
RCR-12.7	1000

MOUNTING HOLE Ø4.0
THICKNESS 1.2-1.6

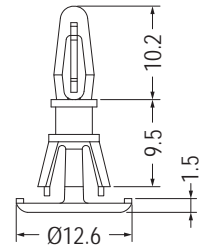

MOUNTING HOLE Ø6.35
THICKNESS 1.0-1.6

Part No.	Package
RCRA-9.5	1000

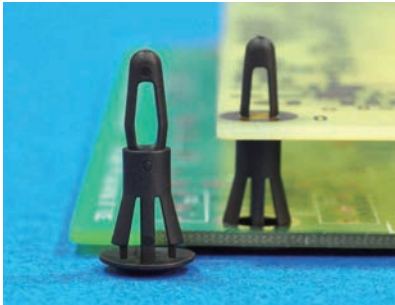

MOUNTING HOLE Ø4.0
THICKNESS 1.6

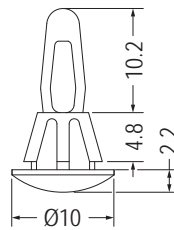

MOUNTING HOLE Ø6.0
THICKNESS 0.8-1.2

Part No.	Package
PCBTA-4.8	1000

MOUNTING HOLE Ø4.0
THICKNESS 1.6

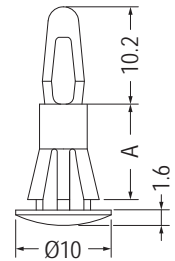

MOUNTING HOLE Ø5.5
THICKNESS 1.0-1.7

Part No.	A	Package
PCBT-4.8	4.8	1000
PCBT-10	10.0	

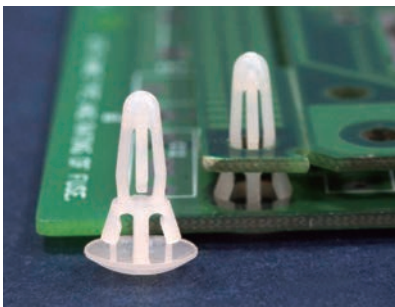

MOUNTING HOLE Ø4.0
THICKNESS 1.2-1.7

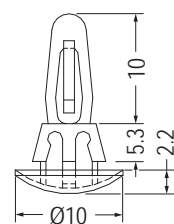

MOUNTING HOLE Ø5.5
THICKNESS 0.8-1.6

Part No.	Package
PCBS-3	1000

MOUNTING HOLE Ø4.0
THICKNESS 1.6

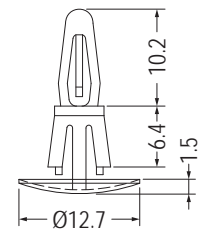

MOUNTING HOLE Ø5.4
THICKNESS 1.2-2.0

Part No.	Package
PCBS-6.4	1000

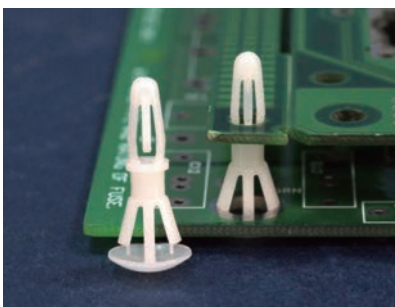

MOUNTING HOLE Ø4.0
THICKNESS 1.6

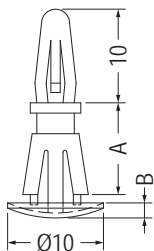

MOUNTING HOLE Ø5.5
THICKNESS 1.0-1.7

Part No.	A	B	Package
PCBS-6	6.3	1.6	1000
PCBS-8	7.9	2.1	
PCBS-10	10.0	2.1	
PCBS-12A	12.0	2.1	
PCBS-12	12.7	1.6	

PCB間隔柱 PCB SPACER

用途：固定PC板於機板上，不會突出機板底部，外觀美麗。

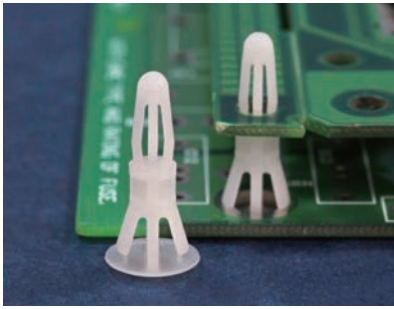

- Material: Nylon 66 (UL)
- Flame Class: 94V-2/94V-0
- Color: Natural/Black
- Unit: mm

MOUNTING HOLE Ø4.0
THICKNESS 1.6

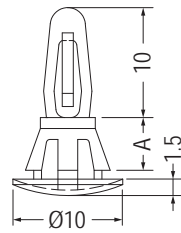

MOUNTING HOLE Ø6.0
THICKNESS 0.8-1.2

Part No.	A	Package
RCFL-4.8	4.8	1000
RCFL-6.4	6.4	

MOUNTING HOLE Ø4.0
THICKNESS 1.6

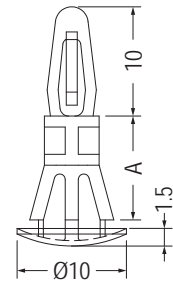

MOUNTING HOLE Ø6.0
THICKNESS 0.8-1.2

Part No.	A	Package
RCFL-8	8.0	1000
RCFL-9.5	9.5	
RCFL-12.7	12.7	
RCFL-15.9	15.9	
RCFL-19	19.0	

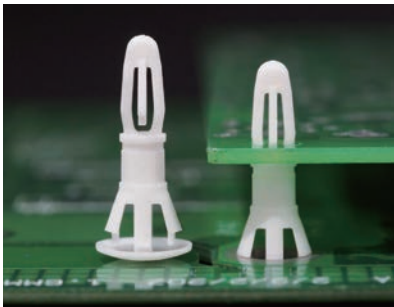

MOUNTING HOLE Ø4.0
THICKNESS 1.6

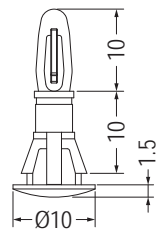

MOUNTING HOLE Ø6.5
THICKNESS 1.6-2.0

Part No.	Package
RCFB-10	1000

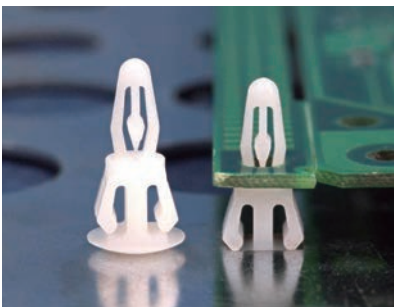

MOUNTING HOLE Ø4.0
THICKNESS 1.6

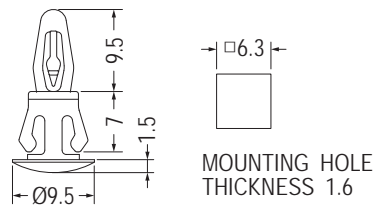

MOUNTING HOLE
THICKNESS 1.6

Part No.	Package
RCFA-7	1000

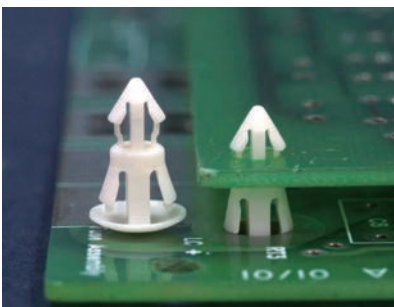

MOUNTING HOLE Ø3.5
THICKNESS 1.6-1.8

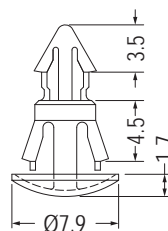

MOUNTING HOLE Ø5.5
THICKNESS 0.8

Part No.	Package
RCTA-4.5	1000

MOUNTING HOLE Ø3.5
THICKNESS 1.2-1.7

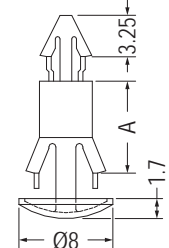

MOUNTING HOLE Ø4.8-Ø5.0
THICKNESS 1.2-1.7

Part No.	A	Package
RCT-4.5	4.5	1000
RCT-8	7.9	

PCB間隔柱 PCB SPACER

用途：固定PC板於機板上，不會突出機板底部，外觀美麗。



- Material: Nylon 66 (UL)
- Flame Class: 94V-2/94V-0
- Color: Natural/Black
- Unit: mm

MOUNTING HOLE Ø4.0
THICKNESS 1.2-1.7

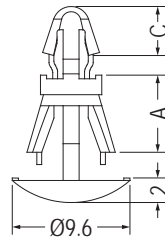

MOUNTING HOLE Ø5.4
THICKNESS 2.0

Part No.	A	C	Package
RCTL-6S	6.0	3.9	1000
RCTL-6	6.3	4.0	
RCTL-12	12.0	3.9	

MOUNTING HOLE Ø4.0
THICKNESS 1.6

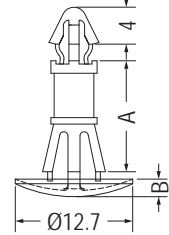

MOUNTING HOLE Ø5.4
THICKNESS 0.8-1.6

Part No.	A	B	Package
RCJ-8	8.0	2.1	1000
RCJ-10	10.0	1.7	
RCJ-12	12.0	1.7	
RCJ-12.7	12.7	1.7	

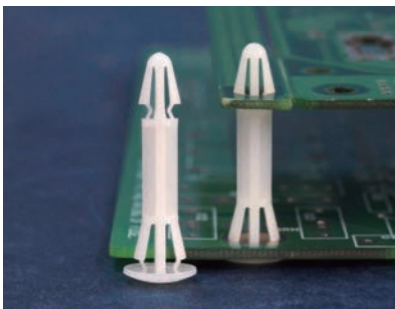

MOUNTING HOLE Ø4.0
THICKNESS 1.2-1.6

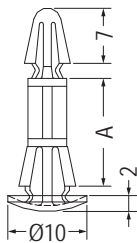

MOUNTING HOLE Ø5.5
THICKNESS 1.2-1.6

Part No.	A	Package
RBT-19	19.0	1000
RBT-28.2	28.2	

MOUNTING HOLE Ø4.0
THICKNESS 3.0

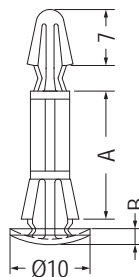

MOUNTING HOLE Ø5.5
THICKNESS 1.2-1.6

Part No.	A	B	Package
RBT-16L	16.0	1.8	1000
RBT-25L	25.0	2.0	

MOUNTING HOLE Ø4.0
THICKNESS 1.2-1.7

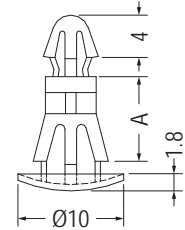

MOUNTING HOLE Ø5.5
THICKNESS 1.2-1.8

Part No.	A	Package
RBS-5	5.0	1000
RBS-6	6.0	
RBS-7	7.0	
RBS-8	8.0	
RBS-10	10.0	
RBS-11	11.0	
RBS-12	12.0	
RBS-14	14.0	
★RBS-16	16.0	
RBS-18	18.0	
RBS-20	20.0	
RBS-23	23.0	

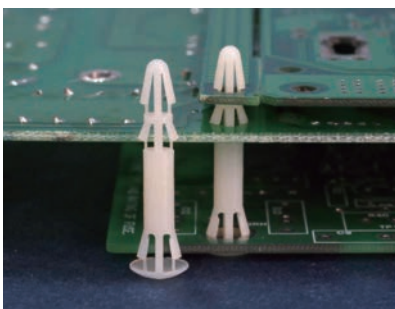

- Material: Nylon 66 (UL)
- Flame Class: 94V-2/94V-0
- Color: Natural/Black
- Unit: mm

用途：用於三層PC板，與機板間之固定，方便、節省空間。

MOUNTING HOLE Ø4.0
THICKNESS 1.6

MOUNTING HOLE Ø4.5
THICKNESS 1.6

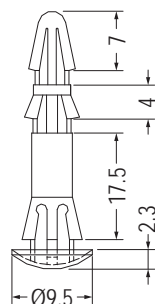

MOUNTING HOLE Ø5.0
THICKNESS 1.6

Part No.	Package
DRCB-18	1000

PCB間隔柱 PCB SPACER

用途：固定PC板於機板上，不會突出機板底部，外觀美麗。

- Material: Nylon 66 (UL)
- Flame Class: 94V-2/94V-0
- Color: Natural/Black
- Unit: mm

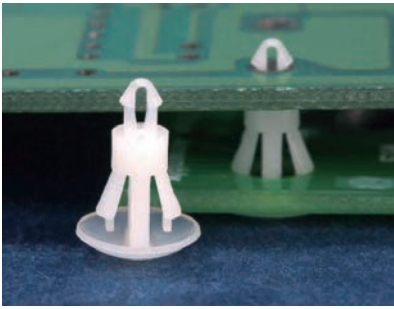

MOUNTING HOLE Ø2.0
THICKNESS 1.6

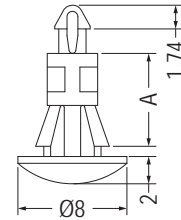

MOUNTING HOLE Ø2.0
THICKNESS 1.6

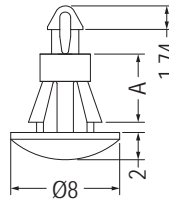

MOUNTING HOLE Ø4.0
THICKNESS 0.8-1.6

MOUNTING HOLE Ø2.0
THICKNESS 1.0

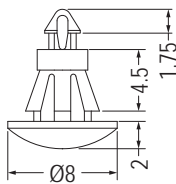

MOUNTING HOLE Ø4.0
THICKNESS 0.8-1.6

Part No.	A	Package
RCAB-3	3.2	1000
RCAB-4	4.0	
RCAB-4.5	4.5	
RCAB-5	5.0	
RCAB-5.5	5.5	

Part No.	A	Package
RCAB-6	6.0	1000
RCAB-6.4	6.4	
RCAB-7	7.0	
RCAB-7.5	7.5	
RCAB-8	8.0	
RCAB-9	9.0	
RCAB-9.5	9.5	
RCAB-10	10.0	
RCAB-11.1	11.1	
RCAB-12	12.0	
RCAB-12.7	12.7	
RCAB-14	14.0	
RCAB-16	16.0	

MOUNTING HOLE Ø4.0
THICKNESS 0.8-1.6

Part No.	Package
RCAB-4.5S	1000

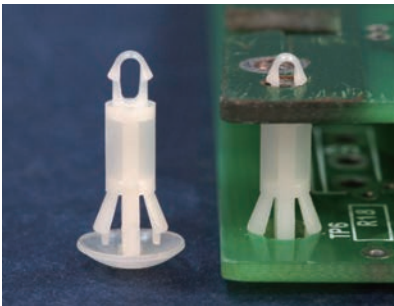

MOUNTING HOLE Ø2.5
THICKNESS 1.6

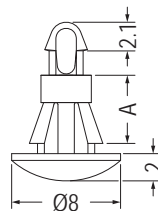

MOUNTING HOLE Ø2.5
THICKNESS 1.6

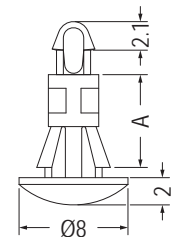

MOUNTING HOLE Ø4.0
THICKNESS 0.8-1.6

Part No.	A	Package
RCAC-3	3.0	1000
RCAC-4	4.0	
RCAC-4.5	4.5	
RCAC-5	5.0	
RCAC-5.5	5.5	

MOUNTING HOLE Ø4.0
THICKNESS 0.8-1.6

Part No.	A	Package
RCAC-6	6.0	1000
RCAC-6.4	6.4	
RCAC-7	7.0	
RCAC-7.5	7.5	
RCAC-8	8.0	
RCAC-9	9.0	
RCAC-9.5	9.5	
RCAC-10	10.0	
RCAC-11.1	11.1	
RCAC-12	12.0	
RCAC-12.7	12.7	
RCAC-14	14.0	
RCAC-16	16.0	

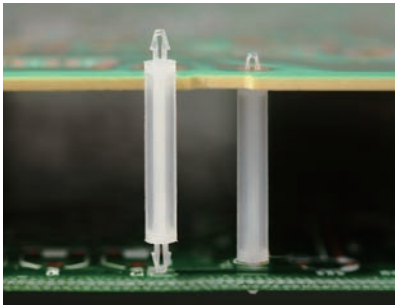

- Material: Nylon 66 (UL)
- Flame Class: 94V-2/94V-0
- Color: Natural/Black
- Unit: mm

MOUNTING HOLE Ø1.5
THICKNESS 1.0

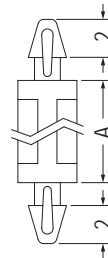

MOUNTING HOLE Ø1.5
THICKNESS 1.0

Part No.	A	Package
MASSD-14	14.0	2000
MASSD-18	18.0	1000

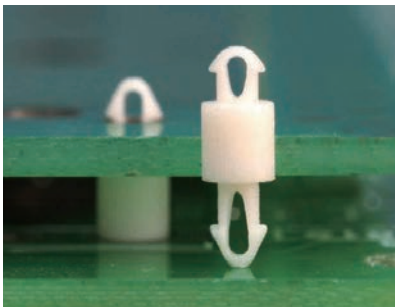

MOUNTING HOLE Ø1.6
THICKNESS 1.0

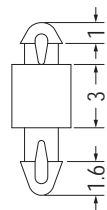

MOUNTING HOLE Ø1.6
THICKNESS 1.6

Part No.	Package
MADSA-3	1000

MOUNTING HOLE Ø1.6
THICKNESS 1.0

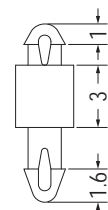

MOUNTING HOLE Ø1.6
THICKNESS 2.0

Part No.	Package
MADSB-3	2000

MOUNTING HOLE Ø1.6
THICKNESS 0.7

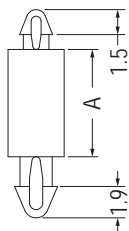

MOUNTING HOLE Ø2.0
THICKNESS 1.6

Part No.	A	Package
MADS-6.5	6.5	2000
MADS-19.2	19.2	1000

MOUNTING HOLE Ø1.6
THICKNESS 1.5

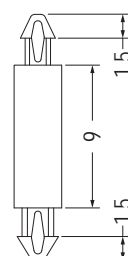

MOUNTING HOLE Ø2.0
THICKNESS 1.6

Part No.	Package
MAS-9	1000

MOUNTING HOLE Ø1.7
THICKNESS 1.7

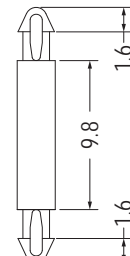

MOUNTING HOLE Ø1.7
THICKNESS 1.7

Part No.	Package
MAD1.7-9.8	1000

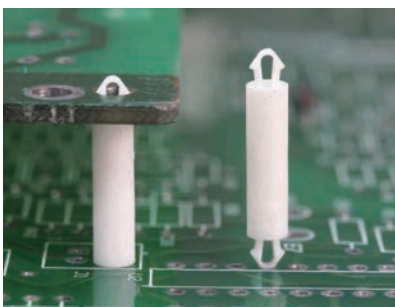

MOUNTING HOLE Ø2.0
THICKNESS 1.0

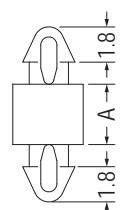

MOUNTING HOLE Ø2.0
THICKNESS 1.0

Part No.	A	Package
MAD1-3	3.0	2000
MAD1-19	19.0	1000

MOUNTING HOLE Ø2.0
THICKNESS 1.0-1.2

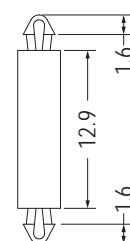

MOUNTING HOLE Ø2.0
THICKNESS 1.0-1.2

Part No.	Package
MAD1.2-12.9	1000

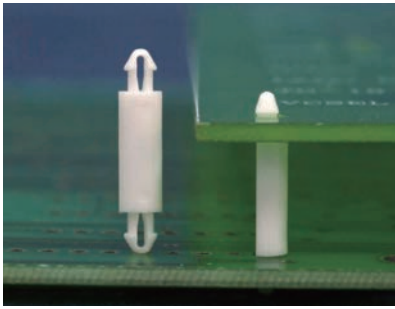

- Material: Nylon 66 (UL)
- Flame Class: 94V-2/94V-0
- Color: Natural/Black
- Unit: mm

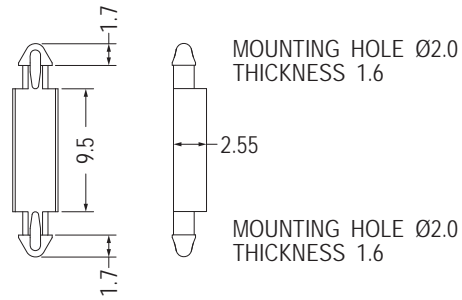

Part No.	Package
MADX-9.5	1000

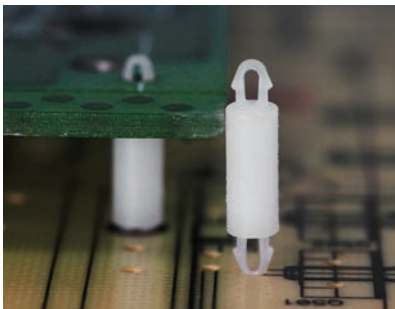

MOUNTING HOLE Ø2.0
THICKNESS 1.2

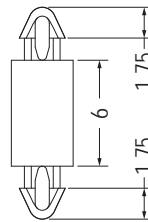

Part No.	Package
MAD1.2-6	1000

MOUNTING HOLE Ø2.0
THICKNESS 1.2

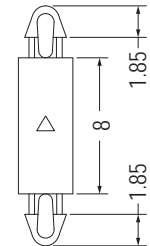

MOUNTING HOLE Ø2.0
THICKNESS 1.2

Part No.	Package
MAD1.2-8	1000

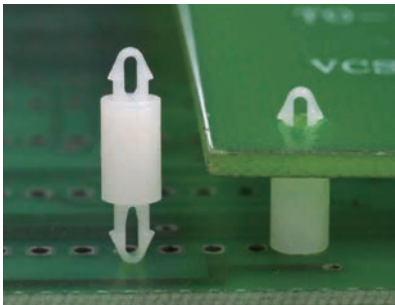

MOUNTING HOLE Ø2.0
THICKNESS 1.6

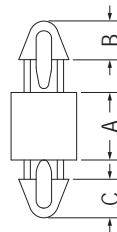

Part No.	A	B	C	T	Package
MADB-3.5	3.5	2.0	2.0	0.9	2000
MADB-6	6.0	1.9	1.9	0.8	

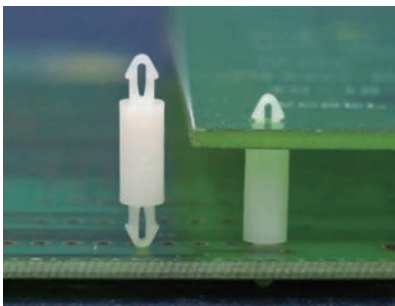

MOUNTING HOLE Ø2.0
THICKNESS 1.6

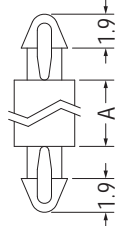

MOUNTING HOLE Ø2.0
THICKNESS 1.6

【 MAD-14 】

MOUNTING HOLE Ø2.0
THICKNESS 1.6

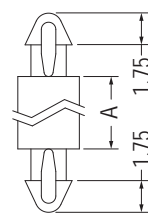

MOUNTING HOLE Ø2.0
THICKNESS 1.6

Part No.	A	Package
MAD-1.6	1.6	2000
MAD-2.2	2.2	
MAD-3	3.0	
MAD-3.5	3.5	
MAD-4	4.0	
MAD-5	5.0	
MAD-6	6.0	
MAD-6.5	6.5	
MAD-7	7.0	
MAD-8	8.0	
MAD-10S	10.0	
MAD-10	10.5	
MAD-12.5	12.5	
MAD-14	14.0	
MAD-25	25.0	

PCB間隔柱 PCB SPACER

用途：PC板與PC板間之固定，不佔空間。

1

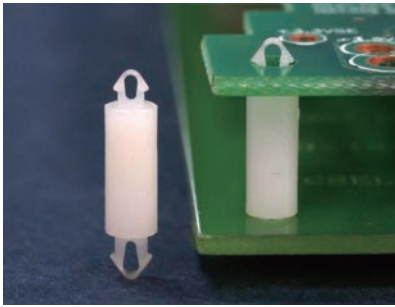

- Material: Nylon 66 (UL)
- Flame Class: 94V-2/94V-0
- Color: Natural/Black
- Unit: mm

MOUNTING HOLE $\varnothing 2.0$
THICKNESS 1.0

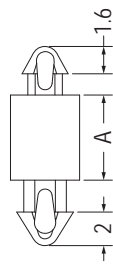

MOUNTING HOLE $\varnothing 2.5$
THICKNESS 1.6

Part No.	A	Package
MAMDA-1.6	1.6	1000
MAMDA-2.5	2.5	
MAMDA-3.2	3.2	
MAMDA-4	4.0	
MAMDA-4.8	4.8	
MAMDA-5.5	5.5	
MAMDA-6.4	6.4	
MAMDA-7	7.0	
MAMDA-7.9	7.9	
MAMDA-9.5	9.5	
MAMDA-10	10.0	
MAMDA-12.7	12.7	

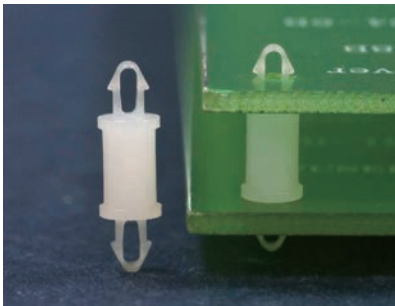

MOUNTING HOLE $\varnothing 2.2$
THICKNESS 1.6

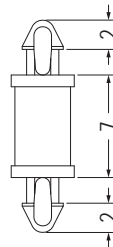

MOUNTING HOLE $\varnothing 2.2$
THICKNESS 1.6

Part No.	Package
MAHA-7	1000

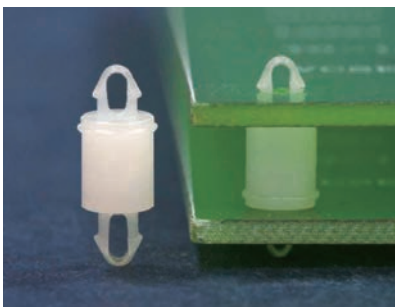

MOUNTING HOLE $\varnothing 2.5$
THICKNESS 1.0

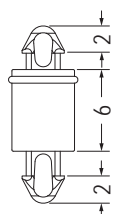

MOUNTING HOLE $\varnothing 2.5$
THICKNESS 1.6

Part No.	Package
MADJ-6	2000

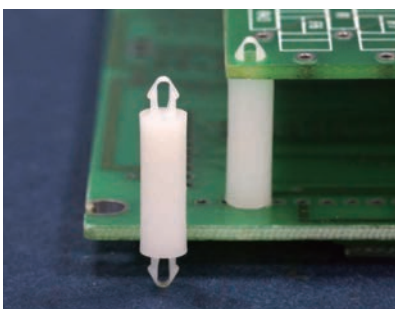

MOUNTING HOLE $\varnothing 2.5$
THICKNESS 0.6

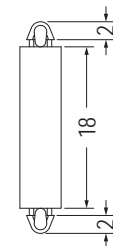

MOUNTING HOLE $\varnothing 2.5$
THICKNESS 0.6

Part No.	Package
MADA-18S	2000

MOUNTING HOLE $\varnothing 2.5$
THICKNESS 1.6

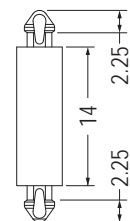

MOUNTING HOLE $\varnothing 2.5$
THICKNESS 1.6

Part No.	Package
MADAA-14	1000

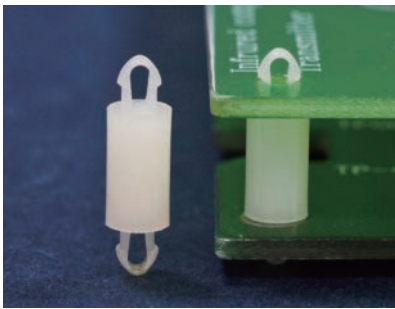

- Material: Nylon 66 (UL)
- Flame Class: 94V-2/94V-0
- Color: Natural/Black
- Unit: mm

MOUNTING HOLE Ø2.5
THICKNESS 1.8

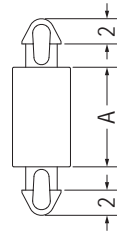

MOUNTING HOLE Ø2.5
THICKNESS 1.8



Part No.	A	Package
MADA-6L	6.0	2000
MADA-7.9L	7.9	
MADA-9.5L	9.5	

MOUNTING HOLE Ø2.5
THICKNESS 1.6

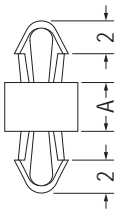

MOUNTING HOLE Ø2.5
THICKNESS 1.6

【 MADA-3-1 】

MOUNTING HOLE Ø2.5
THICKNESS 1.6

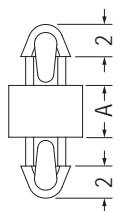

MOUNTING HOLE Ø2.5
THICKNESS 1.6

Part No.	A	Package
MADA-2	2.0	2000
MADA-3	3.0	
MADA-3-1	3.0	
MADA-3.5	3.5	
MADA-4	4.0	
MADA-5	5.0	
MADA-6	6.0	
MADA-6.7	6.7	
MADA-7	7.0	
MADA-8	8.0	
MADA-8.5	8.5	

Part No.	A	Package
MADA-9	9.0	2000
MADA-10	10.0	
MADA-11	11.0	
MADA-12	12.0	
MADA-12.7	12.7	
MADA-14	14.0	
MADA-16	16.0	
MADA-18	18.0	
MADA-20	20.0	
MADA-22	22.0	

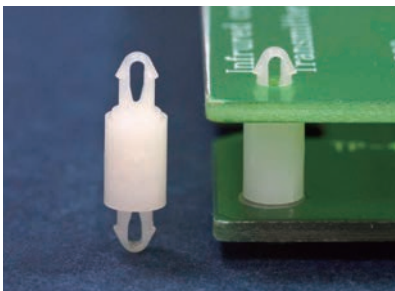

MOUNTING HOLE Ø2.5
THICKNESS 2.2

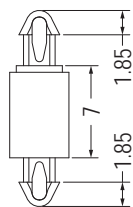

MOUNTING HOLE Ø2.5
THICKNESS 1.7

Part No.	Package
MAMDF-7	1000

MOUNTING HOLE Ø2.5
THICKNESS 2.0

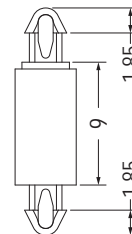

MOUNTING HOLE Ø2.5
THICKNESS 1.2-1.7

Part No.	Package
MAMDL-9	1000

MOUNTING HOLE Ø2.5
THICKNESS 1.6

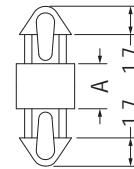

MOUNTING HOLE Ø2.5
THICKNESS 1.6

Part No.	A	Package
MADM-2.7S	2.7	2000
MADM-3S	3.0	

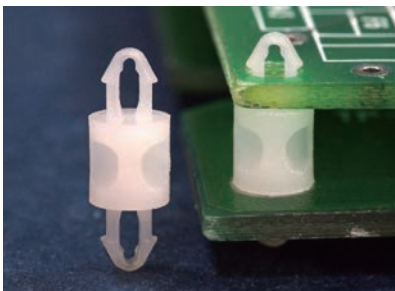

MOUNTING HOLE Ø2.5
THICKNESS 1.6

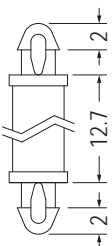

MOUNTING HOLE Ø2.5
THICKNESS 1.6

Part No.	Package
MADM-12.7	2000

MOUNTING HOLE Ø2.5
THICKNESS 1.6

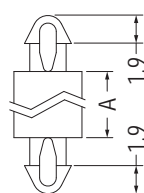

MOUNTING HOLE Ø2.5
THICKNESS 1.6

【 MADM-2, MADM-3,
MADM-4.5 】

MOUNTING HOLE Ø2.5
THICKNESS 1.6

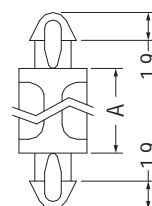

MOUNTING HOLE Ø2.5
THICKNESS 1.6

Part No.	A	Package
MADM-2	2.0	2000
MADM-3	3.0	
MADM-4	4.0	
MADM-4.5	4.5	
MADM-5	5.0	
MADM-6	6.0	
MADM-6.5	6.5	
MADM-7.5	7.5	
MADM-8	8.0	
MADM-9.5	9.5	
MADM-10A	10.0	
MADM-10	10.5	
MADM-27	27.0	

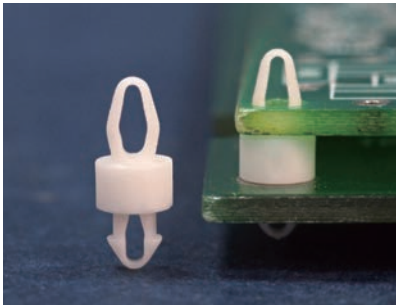

- Material: Nylon 66 (UL)
- Flame Class: 94V-2/94V-0
- Color: Natural/Black
- Unit: mm

MOUNTING HOLE Ø2.5
THICKNESS 1.0

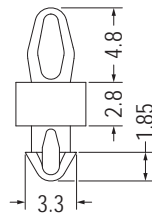

MOUNTING HOLE Ø2.5
THICKNESS 1.6

Part No.	Package
MADE-2.8	1000

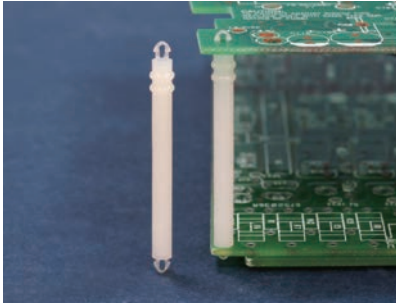

MOUNTING HOLE Ø2.5
THICKNESS 1.6

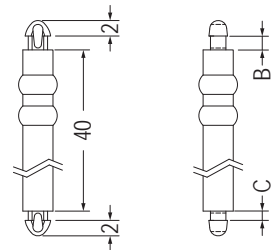

MOUNTING HOLE Ø2.5
THICKNESS 1.0

Part No.	B	C	Package
MAC-40	1.8	1.2	500
MAC-40S	1.5	1.0	

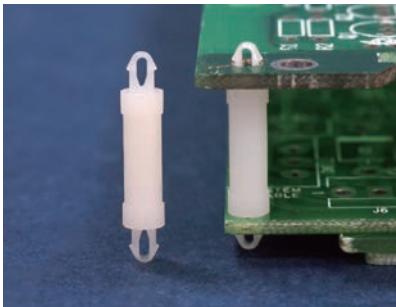

MOUNTING HOLE Ø2.5
THICKNESS 2.0



MOUNTING HOLE Ø2.5
THICKNESS 2.0

Part No.	Package
MAHC-14.3	1000

MOUNTING HOLE Ø2.6
THICKNESS 1.6

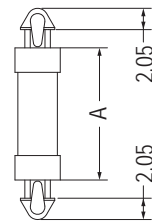

MOUNTING HOLE Ø2.6
THICKNESS 1.6

Part No.	A	Package
MAHC-6.4S	6.4	1000
MAHC-9.5S	9.5	
MAHC-12.7S	12.7	
MAHC-15.9S	15.9	

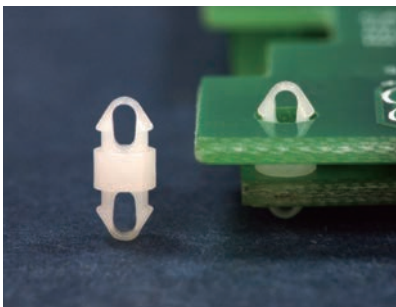

MOUNTING HOLE Ø2.6
THICKNESS 1.0

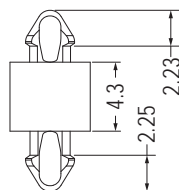

MOUNTING HOLE Ø2.5
THICKNESS 1.6

Part No.	Package
MADAB-4.3	1000

MOUNTING HOLE Ø2.6
THICKNESS 1.0

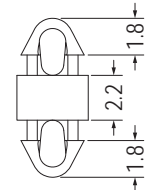

MOUNTING HOLE Ø2.6
THICKNESS 1.0

Part No.	Package
MADM1-2.2	2000

PCB間隔柱 PCB SPACER

用途：PC板與PC板間之固定，不佔空間。

- Material: Nylon 66 (UL)
- Flame Class: 94V-2/94V-0
- Color: Natural/Black
- Unit: mm

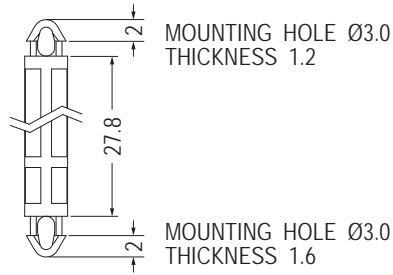
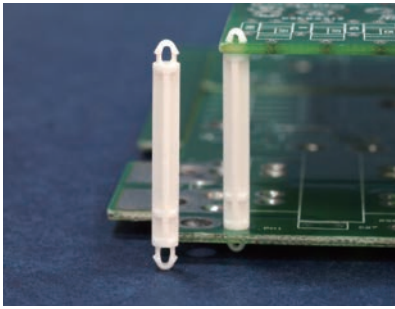

Part No.	Package
MADL-27.8	1000

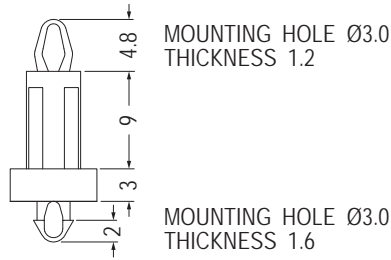
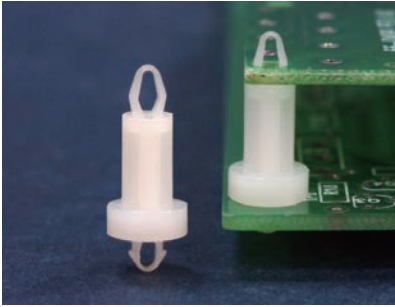

Part No.	Package
MAMDC-12	1000

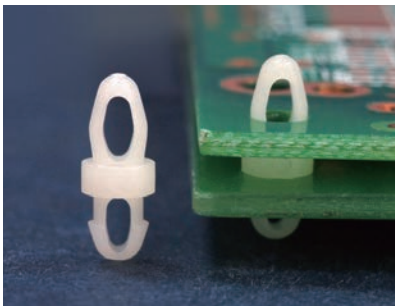

MOUNTING HOLE Ø3.1
THICKNESS 1.4-1.6

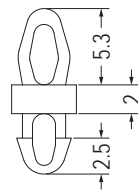

Part No.	Package
MADD-2	1000

MOUNTING HOLE Ø3.0
THICKNESS 1.45-1.6

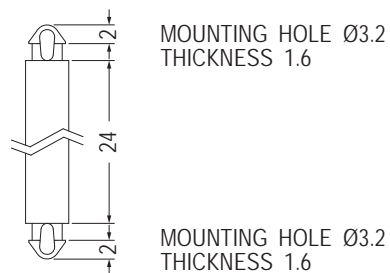
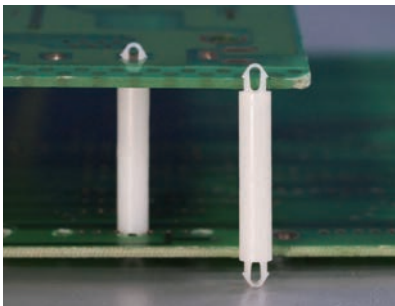

Part No.	Package
MADN-24	1000

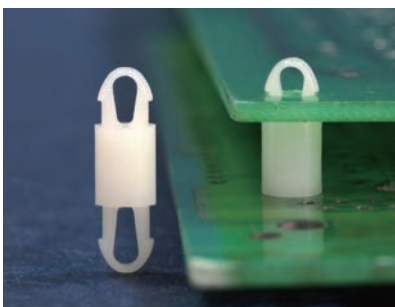

MOUNTING HOLE Ø3.5
THICKNESS 1.6

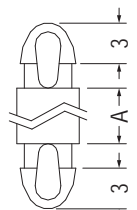

MOUNTING HOLE Ø3.5
THICKNESS 1.6

Part No.	A	Package
MAF-10	10.0	1000
MAF-11	11.0	
MAF-12	12.0	
MAF-14	14.0	
MAF-16	16.0	
MAF-18	18.0	
MAF-20	20.0	
MAF-22	22.0	
MAF-2	2.0	
MAF-3	3.0	
MAF-4	4.0	
MAF-5	5.0	
MAF-6	6.0	
MAF-7	7.0	
MAF-8	8.0	

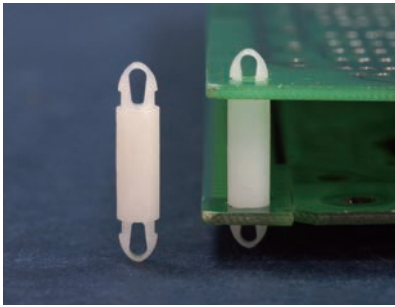

- Material: Nylon 66 (UL)
- Flame Class: 94V-2/94V-0
- Color: Natural/Black
- Unit: mm

MOUNTING HOLE Ø3.5
THICKNESS 1.6

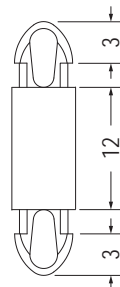

MOUNTING HOLE Ø3.5
THICKNESS 1.6

Part No.	Package
MAD3.5-12	1000

MOUNTING HOLE Ø3.5
THICKNESS 2.1

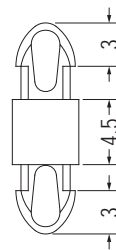

MOUNTING HOLE Ø3.5
THICKNESS 1.6

Part No.	Package
MDLS-4.5	1000

MOUNTING HOLE Ø3.5
THICKNESS 1.6

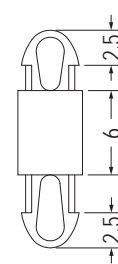

MOUNTING HOLE Ø3.5
THICKNESS 2.5

Part No.	Package
MAFA-6	1000

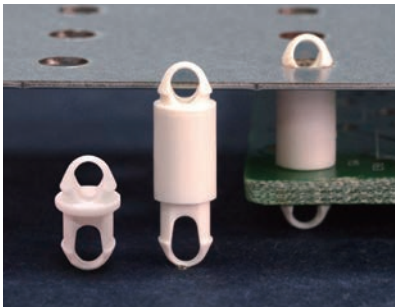

MOUNTING HOLE Ø5.0
THICKNESS 0.8

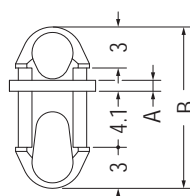

MOUNTING HOLE Ø5.0
THICKNESS 4.0

Part No.	A	B	Package
MAFB5-0.8	0.8	11.8	500
MAFB5-9.7	9.7	20.7	

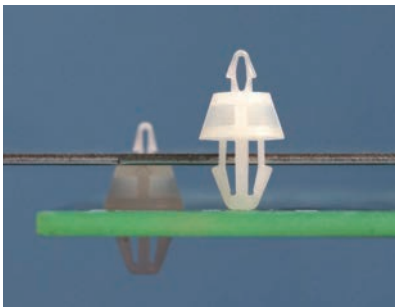

MOUNTING HOLE Ø1.5
THICKNESS 0.8

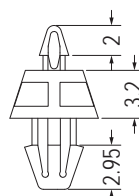

MOUNTING HOLE Ø3.0
THICKNESS 1.6

Part No.	Package
MAEB-3.2	1000

MOUNTING HOLE Ø2.5
THICKNESS 1.0

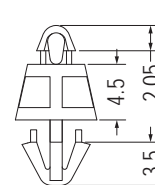

MOUNTING HOLE Ø4.0
THICKNESS 1.6

Part No.	Package
MAEE-4.5	1000

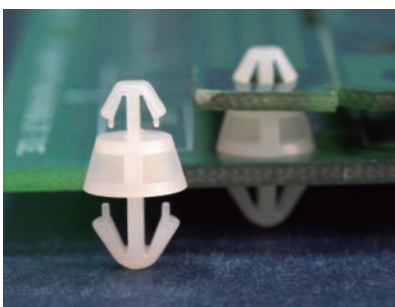

MOUNTING HOLE Ø3.0
THICKNESS 1.0

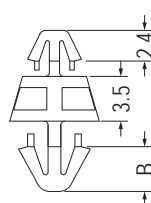

MOUNTING HOLE Ø4.0
THICKNESS: T

MOUNTING HOLE Ø3.0
THICKNESS 1.0

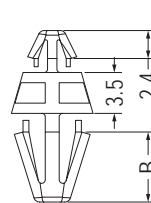

MOUNTING HOLE Ø4.8
THICKNESS: T

Part No.	B	T	Package
MAEA-3.5M	3.5	1.6	1000
MAEA-3.5	6.0	1.2	
MAEA-3.5L	6.0	1.6	
MAEA-3.5LS	4.1	1.6	

【 MAEA-3.5M 】

PCB間隔柱 PCB SPACER

用途：PC板與PC板間之固定，不佔空間。

- Material: Nylon 66 (UL)
- Flame Class: 94V-2/94V-0
- Color: Natural/Black
- Unit: mm

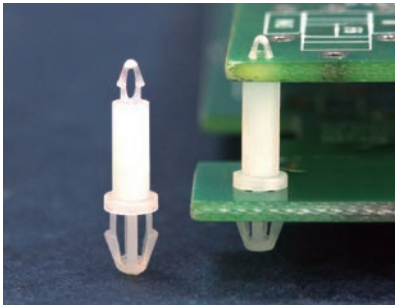

MOUNTING HOLE $\varnothing 1.5$
THICKNESS 1.0

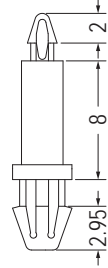

Part No.	Package
LCMB-8	1000

MOUNTING HOLE $\varnothing 3.0$
THICKNESS 1.6

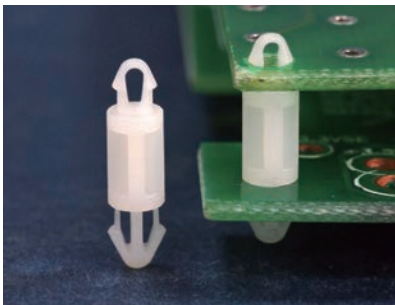

MOUNTING HOLE $\varnothing 2.5$
THICKNESS 1.6

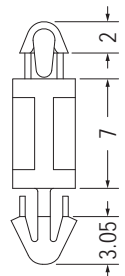

MOUNTING HOLE $\varnothing 3.0$
THICKNESS 1.6

Part No.	Package
LCMC-7	1000

MOUNTING HOLE $\varnothing 3.5$
THICKNESS 2.4

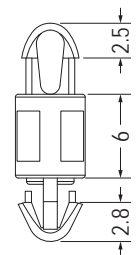

MOUNTING HOLE $\varnothing 3.5$
THICKNESS 1.6

Part No.	Package
MAMDD-6	1000

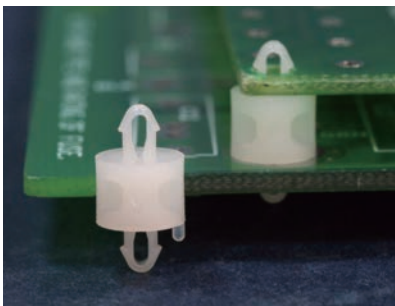

MOUNTING HOLE $\varnothing 2.5$
THICKNESS 1.6

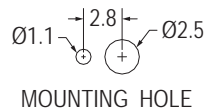
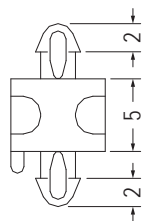

MOUNTING HOLE $\varnothing 2.5$
THICKNESS 1.6

Part No.	Package
MADMK-5	2000

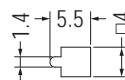

MOUNTING HOLE
THICKNESS: T

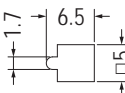
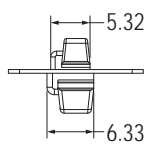
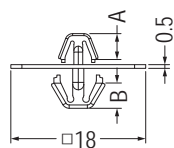

MOUNTING HOLE
THICKNESS 1.0-1.5

Part No.	A	B	T	Package
KVD-05	3.5	3.4	0.5	500
KVD-10	3.6	3.5	1.0	

PCB導電間隔柱 PCB CONDUCTIVE SPACER

用途：快速固定PC板於機板上，上下板可導電，抗E.M.I美觀。

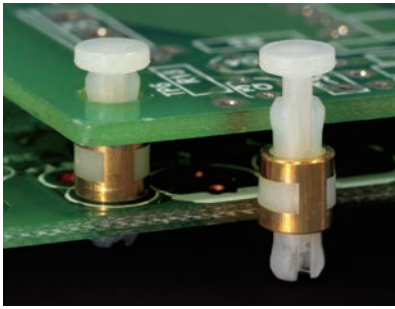

- Material: Nylon 66 (UL)
- Flame Class: 94V-2/94V-0
- Color: Natural/Black
- Unit: mm
- Patented (專利品)

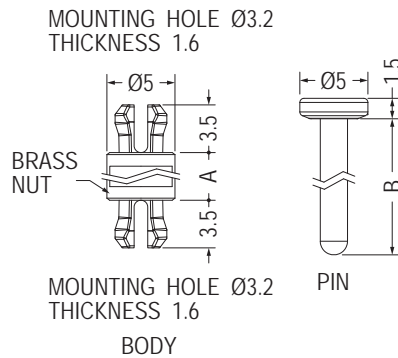

Part No.	A	B	Package
MSPP-3	3.0	10.0	1000
MSPP-4	4.0	11.0	
MSPP-5	5.0	12.0	

PCB間隔柱 PCB SPACER

用途：PC板與PC板間之固定，不佔空間。

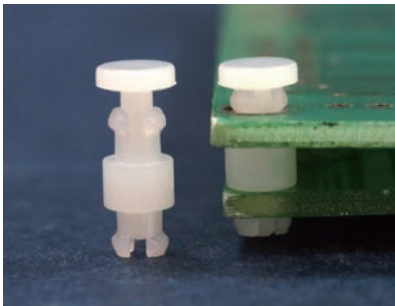

- Material: Nylon 66 (UL)
- Flame Class: 94V-2/94V-0
- Color: Natural/Black
- Unit: mm

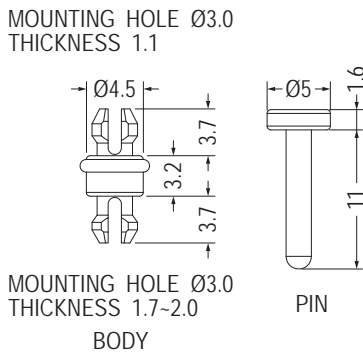

Part No.	Package
MSPC3-3.2L	1000

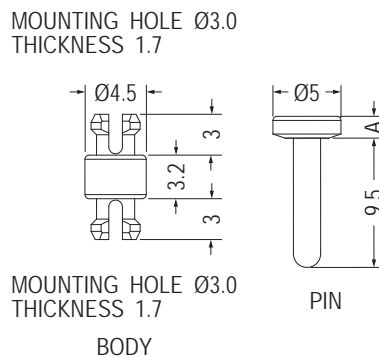

Part No.	A	Package
MSPC3-3.2	1.6	1000
MSPC3-3.2M	3.0	

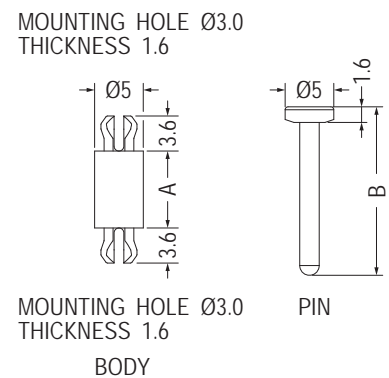

Part No.	A	B	Package
MSPF3-6.4	6.35	15.75	2000
MSPF3-8	7.9	17.3	
MSPF3-10	10.0	19.4	
MSPF3-12.7	12.7	22.1	
MSPF3-15.9	15.9	25.3	

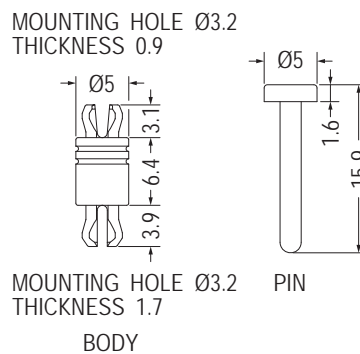
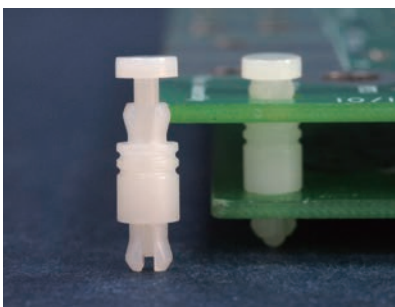

Part No.	Package
MSPB3.2-6.4	1000

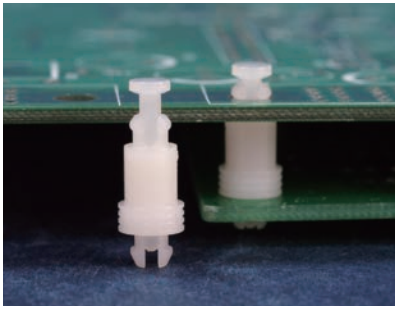

- Material: Nylon 66 (UL)
- Flame Class: 94V-2/94V-0
- Color: Natural/Black
- Unit: mm

MOUNTING HOLE Ø3.3
THICKNESS 1.57

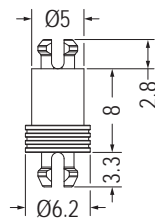

MOUNTING HOLE Ø3.2
THICKNESS 1.72

BODY

Part No.	Package
MSPB-8	1000

MOUNTING HOLE Ø3.3
THICKNESS 1.6

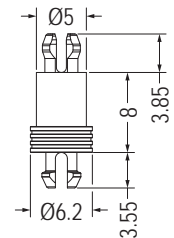

MOUNTING HOLE Ø3.2
THICKNESS 1.8

BODY

Part No.	Package
MSPB-8L	1000

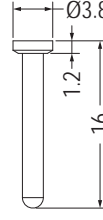

PIN

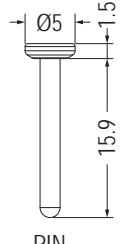

PIN

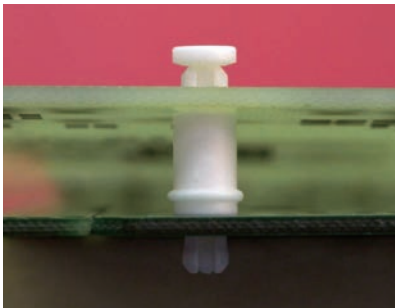

MOUNTING HOLE Ø3.3
THICKNESS 1.6

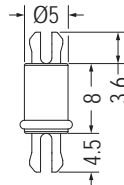

MOUNTING HOLE Ø3.3
THICKNESS 2.44

BODY

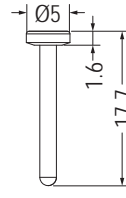

PIN

Part No.	Package
MSPF3.3-8L	1000

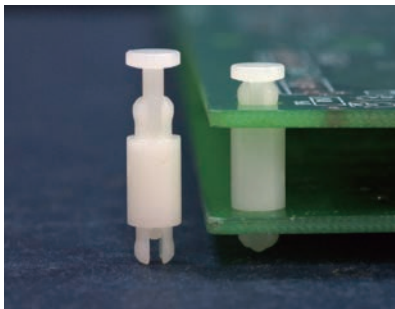

MOUNTING HOLE Ø3.3
THICKNESS 1.6

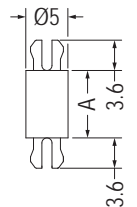

MOUNTING HOLE Ø3.3
THICKNESS 1.6

BODY

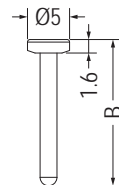

PIN

Part No.	A	B	Package
MSPF3.3-8	8.0	17.35	2000
MSPF3.3-17.5	17.5	26.3	

MOUNTING HOLE Ø3.3
THICKNESS 1.6

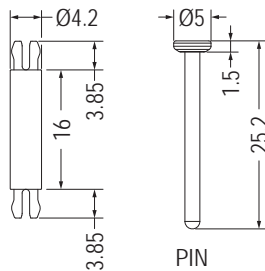

MOUNTING HOLE Ø3.3
THICKNESS 1.6

BODY

Part No.	Package
MSPCA-16	1000

MOUNTING HOLE Ø3.3
THICKNESS 1.6

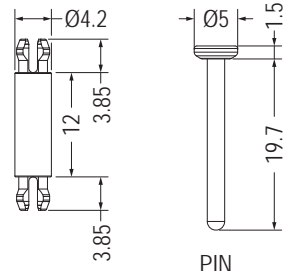

MOUNTING HOLE Ø3.3
THICKNESS 1.6

BODY

Part No.	Package
MSPCA3.3-12S	1000

MOUNTING HOLE Ø3.3
THICKNESS 2.2

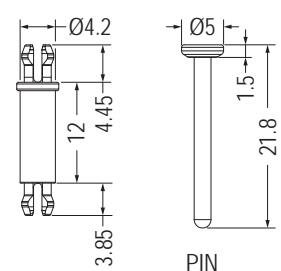

MOUNTING HOLE Ø3.3
THICKNESS 1.6

BODY

Part No.	Package
MSPCA3.3-12	1000

PCB間隔柱 PCB SPACER

用途：PC板與PC板間之固定，不佔空間。

1

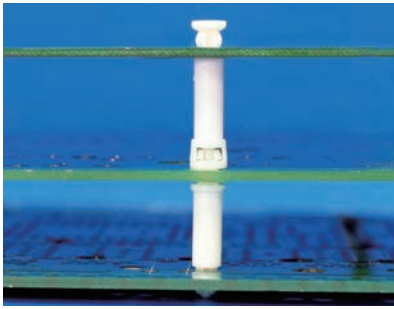

- Material: Nylon 66 (UL)
- Flame Class: 94V-2/94V-0
- Color: Natural/Black
- Unit: mm
- Patented (專利品)

MOUNTING HOLE Ø3.3
THICKNESS 2.2

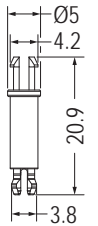

MOUNTING HOLE Ø3.3
THICKNESS 1.6

【 MSPO-1216A 】
BODY



【 MSPO-1216C 】
PIN

MOUNTING HOLE Ø3.3
THICKNESS 1.6

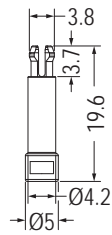

【 MSPO-1216BS 】

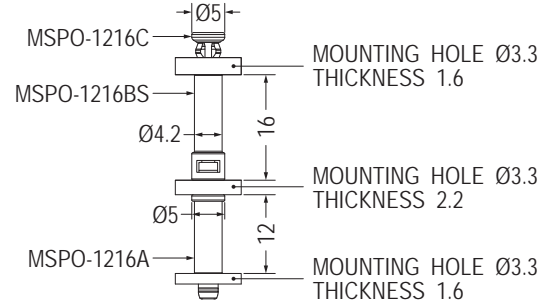

Part No.	Part No.	Package
MSPO-1216S	MSPO-1216A	1000
	MSPO-1216BS	
	MSPO-1216C	

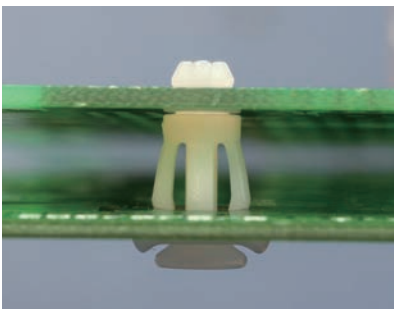

MOUNTING HOLE Ø4.0
THICKNESS 1.6

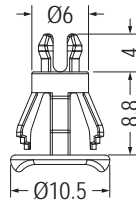

MOUNTING HOLE Ø7.0
THICKNESS 0.8-1.6

BODY

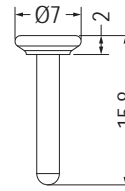

PIN

Part No.	Package
RCQC-7	1000

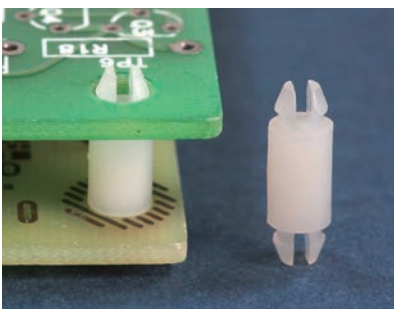

- Material: Nylon 66 (UL)
- Flame Class: 94V-2/94V-0
- Color: Natural/Black
- Unit: mm

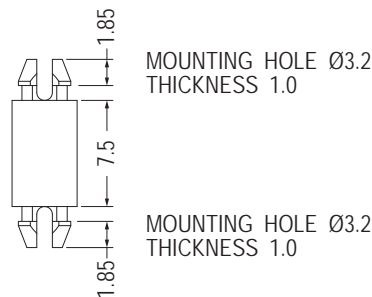

Part No.	Package
MSPS3S-7.5	1000

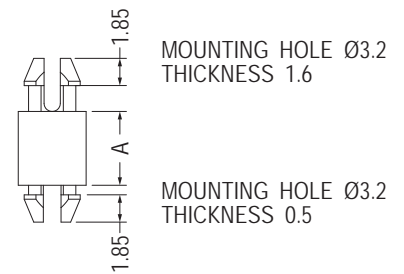

Part No.	A	Package
DMSB-5	5.0	1000
DMSB-8	8.0	

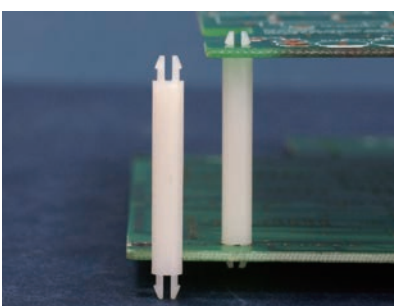

Part No.	A	Package
DMSS-28	28.6	1000
DMSS-38	38.1	

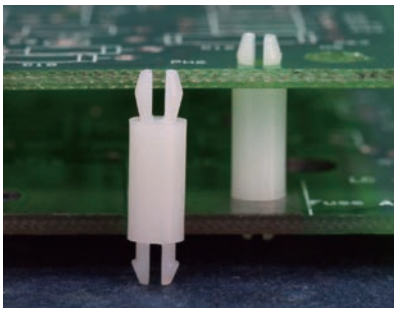

- Material: Nylon 66 (UL)
- Flame Class: 94V-2/94V-0
- Color: Natural/Black
- Unit: mm

MOUNTING HOLE Ø3.2
THICKNESS 1.73

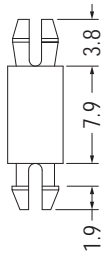

MOUNTING HOLE Ø3.2
THICKNESS 1.6

Part No.	Package
MSP3-8L	1000

MOUNTING HOLE Ø3.2
THICKNESS 1.6

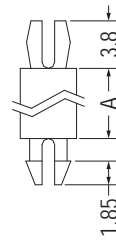

MOUNTING HOLE Ø3.2
THICKNESS 1.6

Part No.	A	Package
★MSP3-1.6	1.6	1000
MSP3-3	3.2	
MSP3-4	4.0	
MSP3-5	4.8	
MSP3-5.8	5.8	
MSP3-6	6.4	
MSP3-8	7.9	
MSP3-8.5	8.5	
MSP3-9.5	9.5	
MSP3-10	10.0	

Part No.	A	Package
MSP3-11	11.1	1000
MSP3-12S	12.0	
MSP3-12	12.7	
MSP3-14	14.3	
MSP3-15.9	15.9	
MSP3-16	16.0	
MSP3-17	17.5	
MSP3-19	19.1	
MSP3-20	20.6	
MSP3-21	21.0	
MSP3-22	22.2	
MSP3-25	25.4	
MSP3-27	27.0	
MSP3-28	28.5	
MSP3-29.2	29.2	
MSP3-31.7	31.7	
MSP3-31.8	31.8	
MSP3-34	34.9	
MSP3-38	38.1	

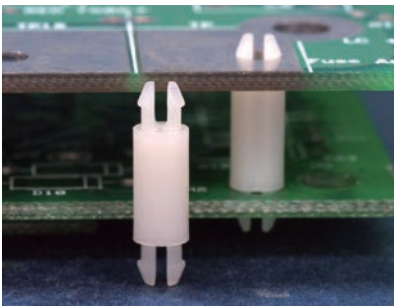

MOUNTING HOLE Ø3.2
THICKNESS 0.8

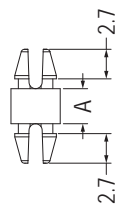

MOUNTING HOLE Ø3.2
THICKNESS 0.8

MOUNTING HOLE Ø3.2
THICKNESS 1.6

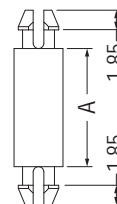

MOUNTING HOLE Ø3.2
THICKNESS 1.6

【 MSPS3-3S, MSPS3-3.2S 】

Part No.	A	Package
MSPS3-1.2	1.2	2000
MSPS3-3S	3.0	
MSPS3-3.2	3.2	1000

Part No.	A	Package
MSPS3-3.2S	3.2	1000
MSPS3-4	4.0	
MSPS3-4.8	4.8	
MSPS3-6.4	6.4	
MSPS3-8	7.9	
MSPS3-8.7	8.7	
MSPS3-9.5	9.5	
MSPS3-11.1	11.1	
MSPS3-12.7	12.7	
MSPS3-14.3	14.3	
MSPS3-15.9	15.9	
MSPS3-19.1	19.1	
MSPS3-20.6	20.6	
MSPS3-22.2	22.2	
MSPS3-25.4	25.4	
MSPS3-31.8	31.8	
MSPS3-34.9	34.9	

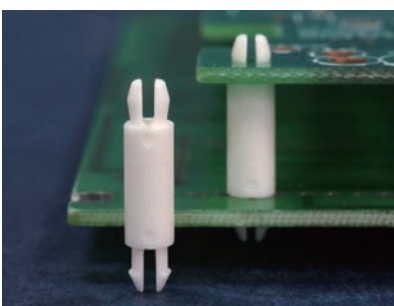

MOUNTING HOLE Ø3.2
THICKNESS 1.6

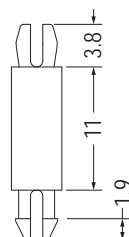

MOUNTING HOLE Ø3.2
THICKNESS 2.4

Part No.	Package
MSPL-11	1000

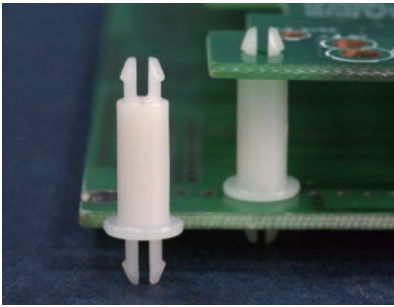

- Material: Nylon 66 (UL)
- Flame Class: 94V-2/94V-0
- Color: Natural/Black
- Unit: mm

MOUNTING HOLE Ø3.2
THICKNESS 1.7

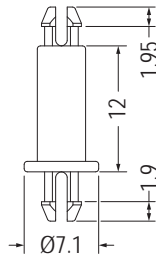

MOUNTING HOLE Ø3.2
THICKNESS 2.7

Part No.	Package
MSPMA-12	1000

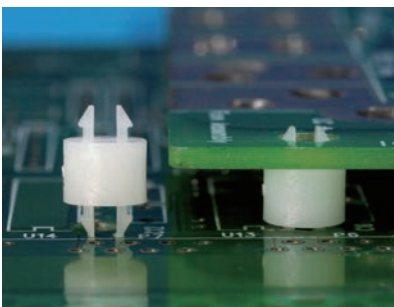

MOUNTING HOLE Ø3.3
THICKNESS 0.8

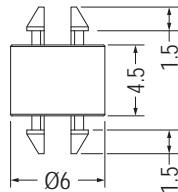

MOUNTING HOLE Ø3.3
THICKNESS 0.8

Part No.	Package
DMSC-4.5	2000

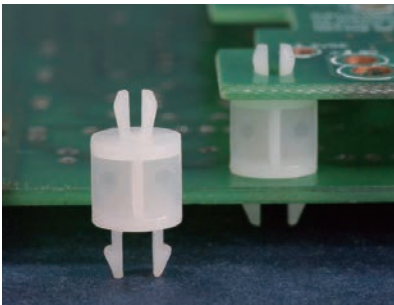

MOUNTING HOLE Ø3.3
THICKNESS 1.6

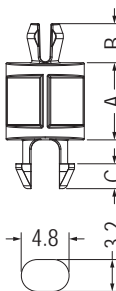

MOUNTING HOLE
THICKNESS: T

Part No.	A	B	C	T	Package
MSPD-7.9	7.9	4.1	2.6	2.16	1000
MSPD-7.9S	7.9	4.1	2.55	1.6	
MSPD-7.9L	7.9	4.1	2.55	2.34	
MSPD-12	12.0	4.1	2.55	2.16	
MSPD-12M	12.0	4.0	2.55	2.7	
MSPD-16	16.0	4.1	2.55	2.16	

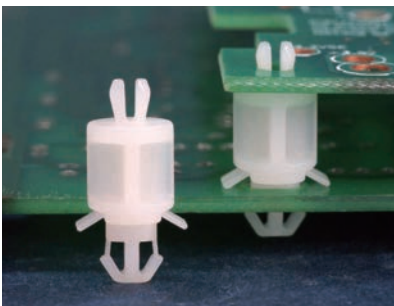

MOUNTING HOLE Ø3.3
THICKNESS 1.6

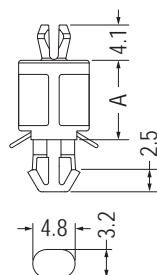

MOUNTING HOLE
THICKNESS 2.7-3.3

Part No.	A	Package
MSPN-9	9.0	1000
MSPN-12	12.0	

- Material: Nylon 66 (UL)
- Flame Class: 94V-2/94V-0
- Color: Natural/Black
- Unit: mm

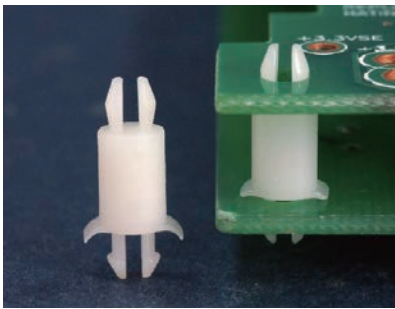

MOUNTING HOLE Ø3.3
THICKNESS 1.6-1.7

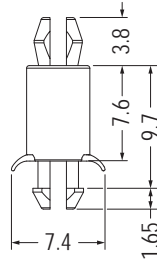

MOUNTING HOLE Ø3.2
THICKNESS 1.7-2.1

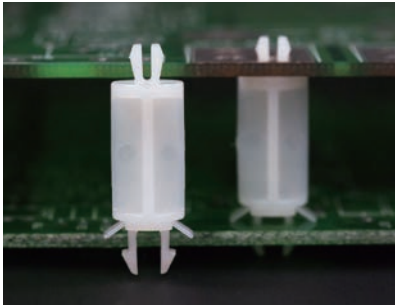

MOUNTING HOLE Ø4.3
THICKNESS 1.6-1.7

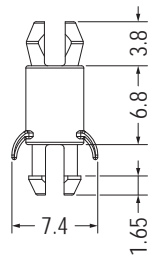

MOUNTING HOLE Ø4.0
THICKNESS 1.7-2.5

MOUNTING HOLE Ø3.3
THICKNESS 1.6

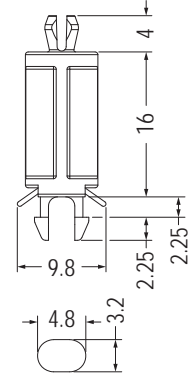

MOUNTING HOLE
THICKNESS 1.8-2.0

Part No.	Package
MSPH-7.5	1000

Part No.	Package
MSPH-6.8L	1000

Part No.	Package
MSPQ-16	1000

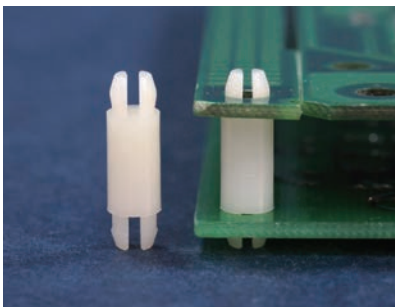

MOUNTING HOLE Ø3.9
THICKNESS 1.6

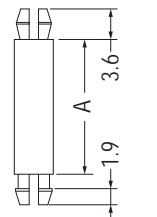

MOUNTING HOLE Ø3.9
THICKNESS 1.6

【 MSP-15.9S 】

MOUNTING HOLE Ø4.0
THICKNESS 1.6

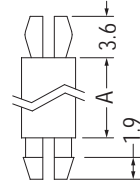

MOUNTING HOLE Ø4.0
THICKNESS 1.6

Part No.	A	Package
MSP-3	3.2	1000
MSP-4	4.0	
MSP-4.5	4.5	
MSP-5	5.0	
MSP-6	6.3	
MSP-7	7.0	
MSP-8	8.0	
MSP-9	9.5	
MSP-10	10.5	
MSP-12	12.7	
MSP-14	14.0	
MSP-15	15.9	
MSP-15.9S	15.9	
MSP-19	19.0	
MSP-22	22.0	

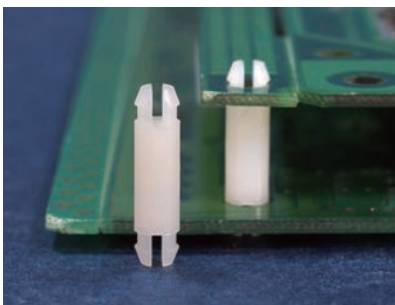

MOUNTING HOLE Ø4.0
THICKNESS 1.6

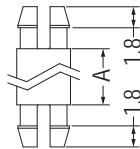

MOUNTING HOLE Ø4.0
THICKNESS 1.6

Part No.	A	Package
DMSP-4.8	4.8	1000
DMSP-6.4	6.4	
DMSP-11.1	11.1	

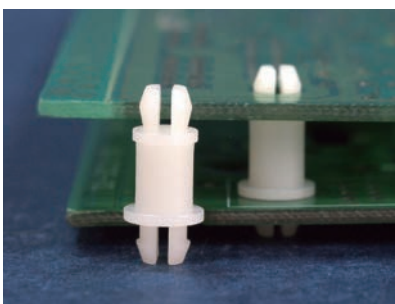

MOUNTING HOLE Ø4.0
THICKNESS 1.6

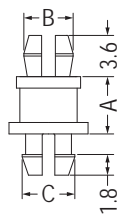

MOUNTING HOLE Ø4.0
THICKNESS 1.6

Part No.	A	B	C	Package
DMSPS-5	5.0	4.3	4.6	1000
DMSPS-6.4	6.4	4.4	4.6	
DMSPS-7.9	7.9	4.3	4.6	
DMSPS-12.7	12.7	4.3	4.6	
DMSPS-17.5	17.5	4.3	4.6	
DMSPS-17.5S	17.5	4.2	4.25	

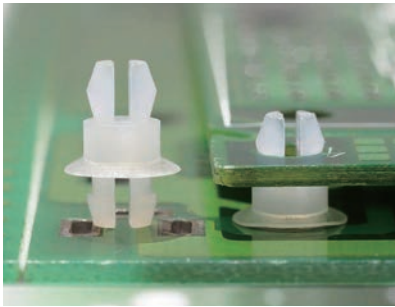

- Material: Nylon 66 (UL)
- Flame Class: 94V-2/94V-0
- Color: Natural/Black
- Unit: mm

MOUNTING HOLE Ø3.9
THICKNESS 1.6

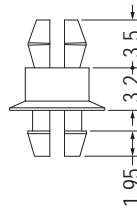

MOUNTING HOLE Ø3.9
THICKNESS 1.6

Part No.	Package
MSPV-3	1000

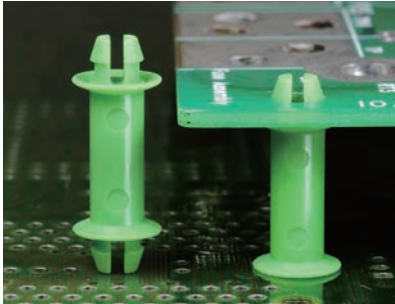

MOUNTING HOLE Ø3.96
THICKNESS 1.58

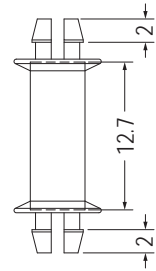

MOUNTING HOLE Ø3.96
THICKNESS 1.58

- Color: Green

Part No.	Package
MSPY-12.7	1000

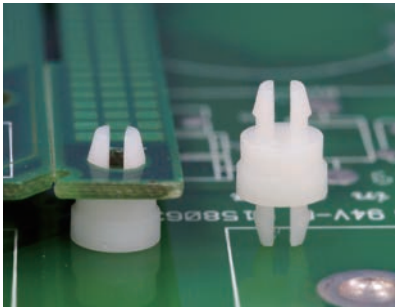

MOUNTING HOLE Ø4.0
THICKNESS 1.57

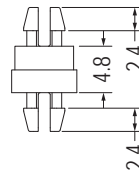

MOUNTING HOLE Ø4.0
THICKNESS 1.57

Part No.	Package
SP1-4.8	2000

MOUNTING HOLE Ø4.0
THICKNESS 1.6

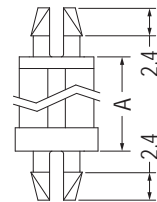

MOUNTING HOLE Ø4.0
THICKNESS 1.6

Part No.	A	Package
MSPM-5	4.8	1000
MSPM-24	23.8	

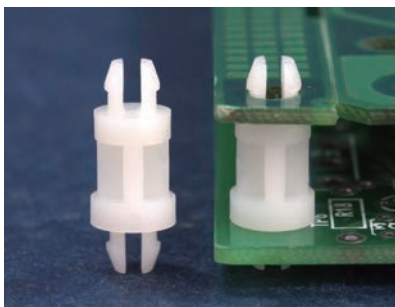

MOUNTING HOLE Ø4.0
THICKNESS 1.6

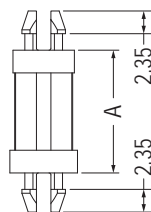

MOUNTING HOLE Ø4.0
THICKNESS 1.6

Part No.	A	Package
MSP1-6.4	6.4	1000
MSP1-9.5	9.5	
MSP1-10	10.0	
MSP1-12.7	12.7	
MSP1-15.9	15.9	
MSP1-17	17.0	
MSP1-19.1	19.1	
MSP1-22.2	22.2	
★MSP1-25	25.0	
MSP1-25.4	25.4	

MOUNTING HOLE Ø4.0
THICKNESS 1.6

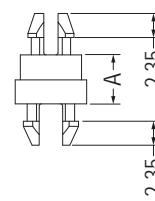

MOUNTING HOLE Ø4.8
THICKNESS 1.6

MOUNTING HOLE Ø4.0
THICKNESS 1.6

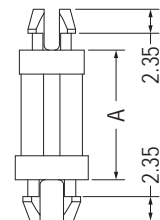

MOUNTING HOLE Ø4.8
THICKNESS 1.6

【 MSPK45-4.8 】

Part No.	A	Package
MSPK45-4.8	4.8	2000
MSPK45-6.4	6.4	
MSPK45-9.5	9.5	
MSPK45-12.7	12.7	1000
MSPK45-15.9	15.9	
MSPK45-19.1	19.1	
MSPK45-22.2	22.2	
MSPK45-25.4	25.4	

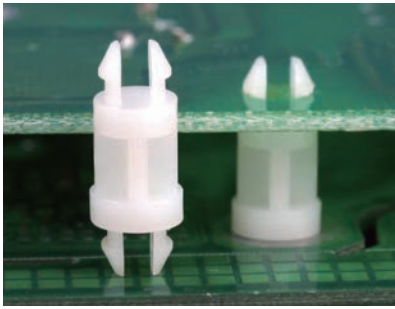

- Material: Nylon 66 (UL)
- Flame Class: 94V-2/94V-0
- Color: Natural/Black
- Unit: mm

MOUNTING HOLE Ø4.8 THICKNESS 1.6

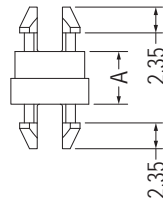

MOUNTING HOLE Ø4.8 THICKNESS 1.6

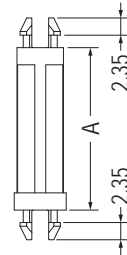

【 MSPK4.8-4.8 】

Part No.	A	Package
MSPK4.8-4.8	4.8	2000
MSPK4.8-6.4	6.4	
MSPK4.8-9.5	9.5	
MSPK4.8-12.7	12.7	
MSPK4.8-15.9	15.9	1000
MSPK4.8-19.1	19.1	
MSPK4.8-22.2	22.2	
MSPK4.8-25.4	25.4	
MSPK4.8-31.7	31.75	

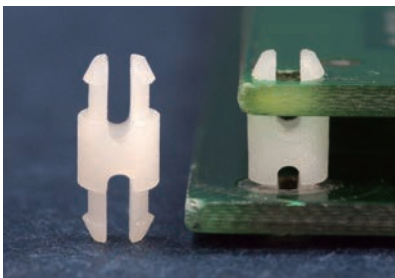

MOUNTING HOLE Ø3.0 THICKNESS 1.6

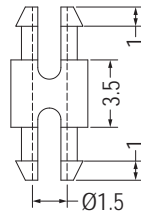

MOUNTING HOLE Ø3.0 THICKNESS 1.6

MOUNTING HOLE Ø4.0 THICKNESS 1.6

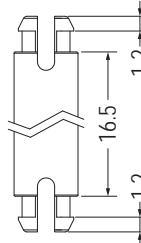

MOUNTING HOLE Ø4.0 THICKNESS 1.6

MOUNTING HOLE Ø4.0 THICKNESS 1.6

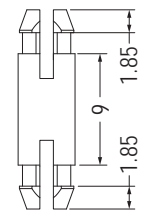

MOUNTING HOLE Ø4.0 THICKNESS 1.6

Part No.	Package
SSDU1-3.5	1000

Part No.	Package
SSDUA-16.5	1000

Part No.	Package
DMSA-9	1000

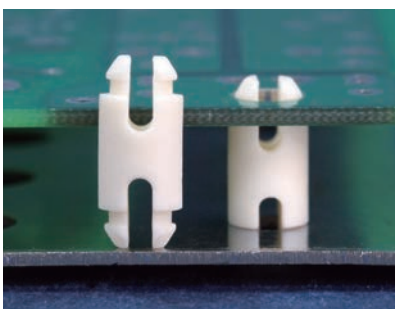
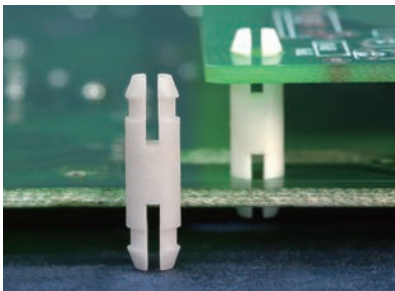

MOUNTING HOLE Ø5.2 THICKNESS: T

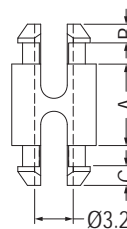

MOUNTING HOLE Ø5.2 THICKNESS: T

Part No.	A	B	C	T	Package
SSDU-9.2	9.2	1.55	1.55	1.6	1000
SSDU-9.6	9.6	1.85	1.85	1.2	

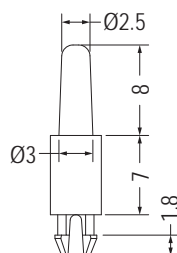
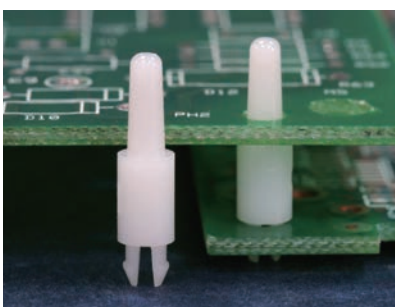

MOUNTING HOLE Ø3.2 THICKNESS 1.6

Part No.	Package
MSPE-7	1000

PCB間隔柱 PCB SPACER

用途：PC板與PC板間之固定，不佔空間。

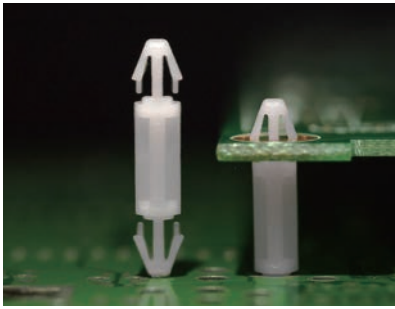

- Material: Nylon 66 (UL)
- Flame Class: 94V-2/94V-0
- Color: Natural/Black
- Unit: mm

MOUNTING HOLE Ø3.0
THICKNESS: T

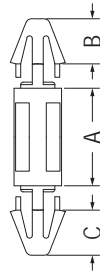

MOUNTING HOLE Ø3.0
THICKNESS: T

Part No.	A	B	C	T	Package
LCVU-8	8.0	3.7	3.7	1.2~1.8	1000
LCVU-9	9.0	3.55	3.55	2.0	
LCVU-10	10.0	3.7	3.7	1.2~1.8	

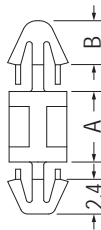

MOUNTING HOLE Ø3.0
THICKNESS: E

MOUNTING HOLE Ø3.0
THICKNESS: T

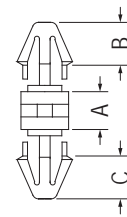

MOUNTING HOLE Ø3.0
THICKNESS: E

MOUNTING HOLE Ø3.0
THICKNESS: T

Part No.	A	B	E	T	Package
LCVA-2	2.0	3.1	1.6	0.8~1.0	2000
LCVA-2.5	2.5	3.0	0.8~1.0	1.6	
LCVA-4	4.0	3.1	1.6	0.8~1.0	
LCVA-5	5.0	3.1	1.6	0.8~1.0	

Part No.	A	B	C	E	T	Package
LCV-2.5	2.5	3.4	3.4	1.6	1.6	1000
LCV-3	3.0	3.55	3.55	1.6	1.6	
LCV-5	5.0	3.4	3.4	1.8	1.8	
LCV-6	6.0	3.6	3.6	1.2~1.7	0.8~1.0	

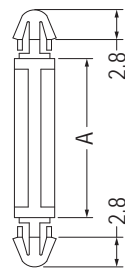
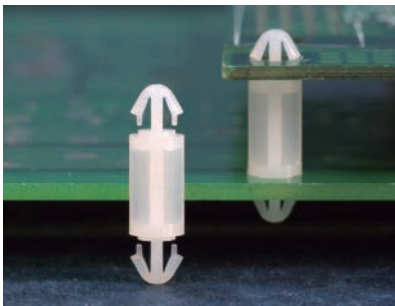

MOUNTING HOLE: ØG
THICKNESS 1.2~1.7

MOUNTING HOLE: ØG
THICKNESS 1.2~1.7

Part No.	A	G	Package
LCJ-14	14.0	3.0	1000
LCJ-15	15.0	3.2	
LCJ-19	19.0	3.0	
LCJ-21	21.0	3.0	

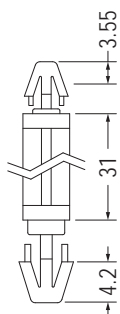

MOUNTING HOLE Ø3.0
THICKNESS 1.2~1.6

MOUNTING HOLE Ø4.0
THICKNESS 3.6~4.0

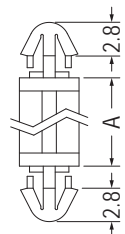

MOUNTING HOLE Ø3.5
THICKNESS: T

MOUNTING HOLE Ø3.5
THICKNESS: T

Part No.	A	T	Package
LCI-2.5	2.5	1.2~1.7	2000
LCI-3	3.0	1.2~1.7	
LCI-3.5	3.5	1.2~1.7	
LCI-4	4.0	1.2~1.7	
LCI-4.5	4.5	1.2~1.7	
LCI-5	5.0	1.2~1.7	
LCI-5.5	5.5	1.2~1.7	

Part No.	A	T	Package
LCI-6	6.0	1.2~1.7	1000
LCI-6.5	6.35	1.2~1.7	
LCI-7	7.0	1.2~1.7	
LCI-8	8.0	1.2~1.7	
LCI-9	9.0	1.2~1.7	
LCI-10	10.0	1.2~1.7	
LCI-10L	10.0	2.38	
LCI-11	11.0	1.2~1.7	
LCI-12	12.0	1.2~1.7	
LCI-15	15.0	1.2~1.7	
LCI-15(2)	15.0	1.6~2.4	
LCI-20	20.0	1.2~1.7	
LCI-22	22.0	1.2~1.7	
LCI-30L	30.0	1.6~2.4	500

Part No.	Package
LCX-31	2000

PCB間隔柱 PCB SPACER

用途：PC板與PC板間之固定，不佔空間。

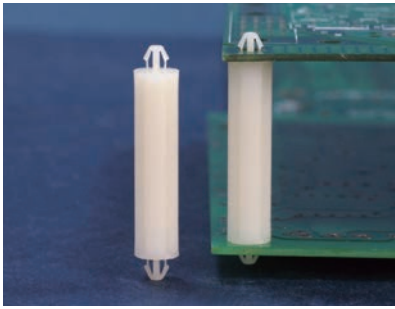

- Material: Nylon 66 (UL)
- Flame Class: 94V-2/94V-0
- Color: Natural/Black
- Unit: mm

MOUNTING HOLE Ø3.5
THICKNESS 1.6

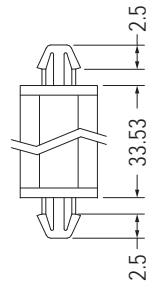

Part No.	Package
LDE-33	1000

MOUNTING HOLE Ø3.5
THICKNESS 1.6

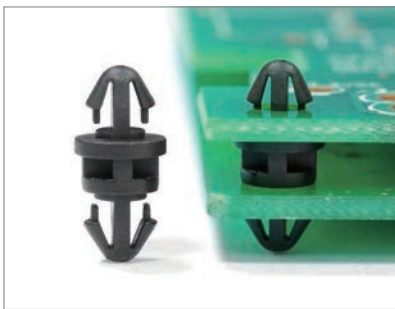

MOUNTING HOLE Ø3.4
THICKNESS 1.2-1.7

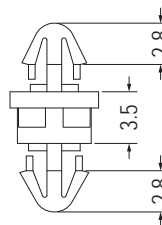

Part No.	Package
LCIA-3.5	1000

MOUNTING HOLE Ø3.7
THICKNESS 1.2-1.7

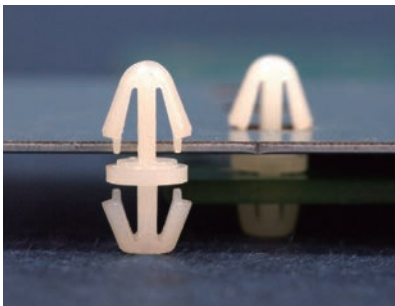

MOUNTING HOLE Ø4.0
THICKNESS 1.2-1.6

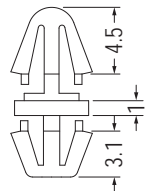

Part No.	Package
LCK-1	1000

MOUNTING HOLE Ø4.0
THICKNESS 0.8

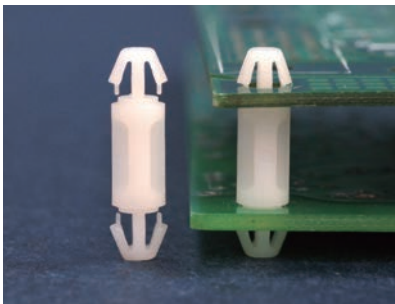

MOUNTING HOLE Ø4.0
THICKNESS 1.2-1.7

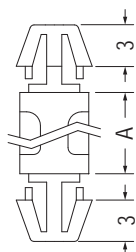

MOUNTING HOLE Ø4.0
THICKNESS 1.2-1.7

Part No.	A	Package	Part No.	A	Package
LCC-3S	3.0	2000	LCC-18	18.0	1000
LCC-3	3.5		LCC-19	19.0	
LCC-4	4.0		LCC-20	20.0	
LCC-5	5.0		LCC-25	25.0	
LCC-6S	6.0		LCC-25.4	25.4	
LCC-6	6.4		LCC-27	27.0	
LCC-7	7.0		LCC-30	30.0	
LCC-8	8.0	1000	LCC-34	34.0	500
LCC-9.5	9.5		LCC-40	40.0	
LCC-10S	10.0		LCC-45	45.0	
LCC-10	10.5		LCC-55	55.0	
LCC-11.5	11.5		LCC-69	69.0	
LCC-12S	12.0		LCC-71	71.2	
LCC-12	12.7		LCC-72	72.0	
LCC-14	14.0		LCC-74	74.2	
LCC-15	15.9		LCC-80	80.0	

PCB間隔柱 PCB SPACER

用途：PC板與PC板間之固定，不佔空間。

1

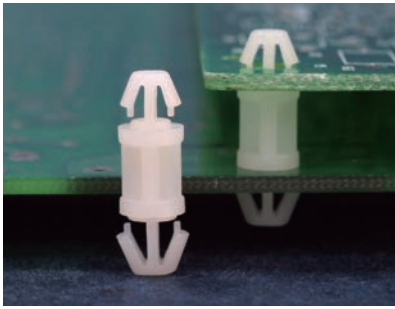

- Material: Nylon 66 (UL)
- Flame Class: 94V-2/94V-0
- Color: Natural/Black
- Unit: mm

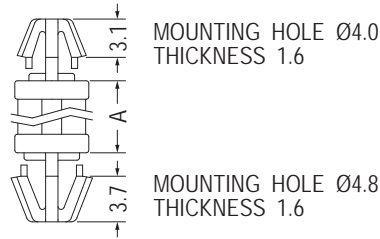

Part No.	A	Package
LCBM-3	3.0	1000
LCBM-4	4.0	
LCBM-6	6.0	
LCBM-8	8.0	
LCBM-10	10.0	
LCBM-12	12.0	
LCBM-14	14.0	
LCBM-16	16.0	
LCBM-18	18.0	

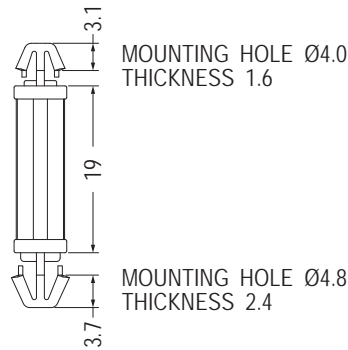

Part No.	Package
LCBM-19L	1000

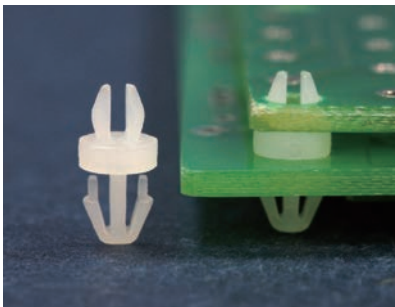

MOUNTING HOLE Ø2.6
THICKNESS 1.0

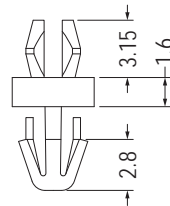

MOUNTING HOLE Ø2.8
THICKNESS 1.6

Part No.	Package
MSPA-1.6	2000

MOUNTING HOLE Ø2.8
THICKNESS 1.6

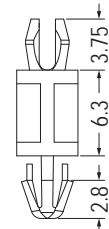

MOUNTING HOLE Ø2.8
THICKNESS 1.6

Part No.	Package
MSPA-6.3L	1000

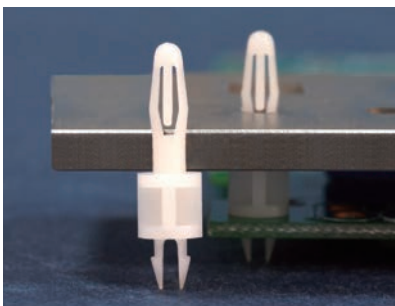

- Material: Nylon 66 (UL)
- Flame Class: 94V-2/94V-0
- Color: Natural/Black
- Unit: mm

MOUNTING HOLE Ø3.0
THICKNESS 4.0

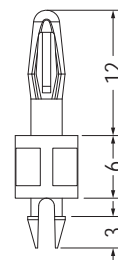

MOUNTING HOLE Ø3.0
THICKNESS 1.6

Part No.	Package
LMSA-6	1000

MOUNTING HOLE Ø3.2
THICKNESS 1.6

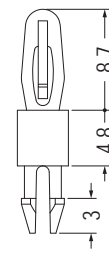

MOUNTING HOLE Ø3.2
THICKNESS 2.6

Part No.	Package
LMSE-4.8	1000

PCB間隔柱 PCB SPACER

用途：PC板與PC板間之固定，不佔空間。



- Material: Nylon 66 (UL)
- Flame Class: 94V-2/94V-0
- Color: Natural/Black
- Unit: mm

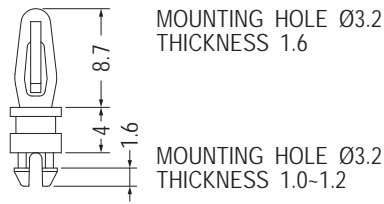

Part No.	Package
LMSB-4	1000

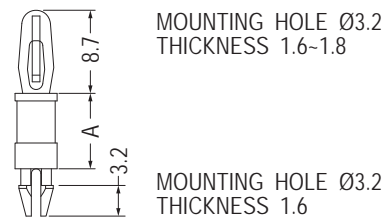
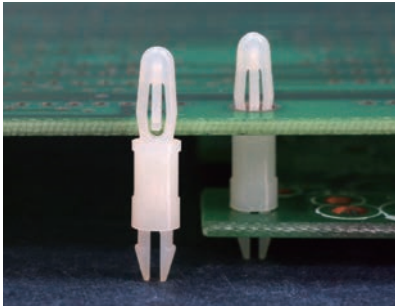

Part No.	A	Package
LMSP-8	7.9	1000
LMSP-9.5	9.5	
LMSP-16	15.9	

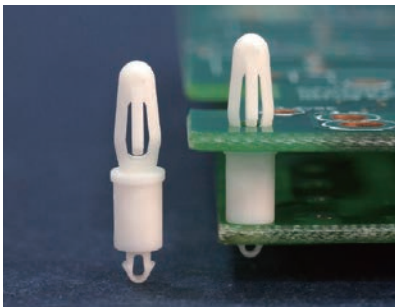

- Material: Nylon 66 (UL)
- Flame Class: 94V-2/94V-0
- Color: Natural/Black
- Unit: mm

MOUNTING HOLE Ø3.2
THICKNESS 1.6-1.7

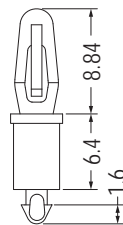

MOUNTING HOLE Ø2.0
THICKNESS 1.0-1.2

Part No.	Package
LCPL-6.4	1000

MOUNTING HOLE Ø3.5
THICKNESS 1.6

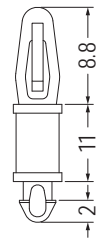

MOUNTING HOLE Ø2.6
THICKNESS 1.6

Part No.	Package
LCPLB-11	1000

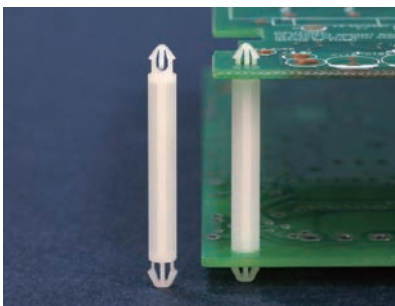

- Material: Nylon 66 (UL)
- Flame Class: 94V-2/94V-0
- Color: Natural/Black
- Unit: mm

MOUNTING HOLE Ø3.3
THICKNESS 1.6-2.1

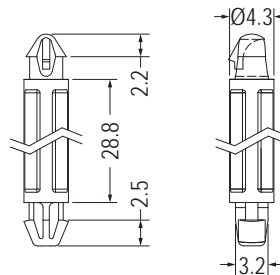

MOUNTING HOLE Ø3.3
THICKNESS 1.6

Part No.	Package
LCOA-28.8	1000

PCB間隔柱 PCB SPACER

用途：PC板與PC板間之固定，不佔空間。

1

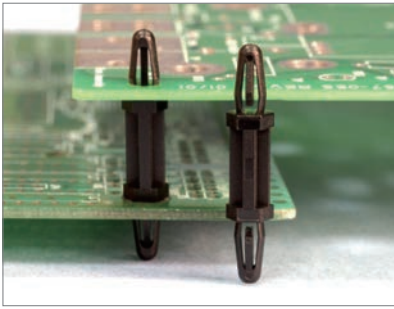

- Material: Nylon 66 (UL)
- Flame Class: 94V-2/94V-0
- Color: Natural/Black
- Unit: mm

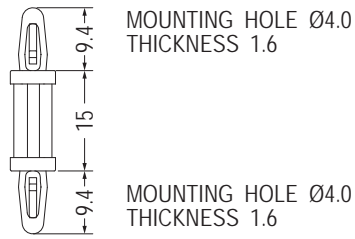

Part No.	Package
LCSF-15	1000

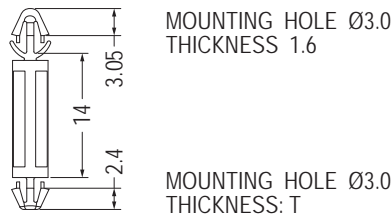
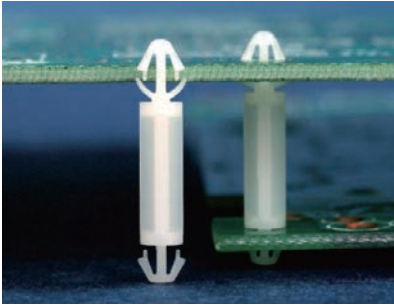

Part No.	T	Package
LCGA-14	0.8-1.0	1000
LCGA-14S	0.6	

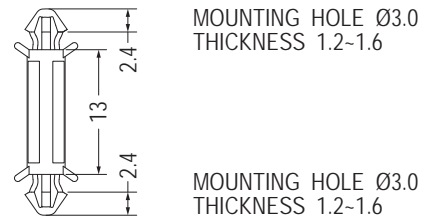
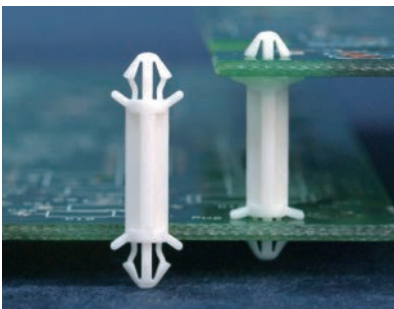

Part No.	Package
CBSA-13	1000

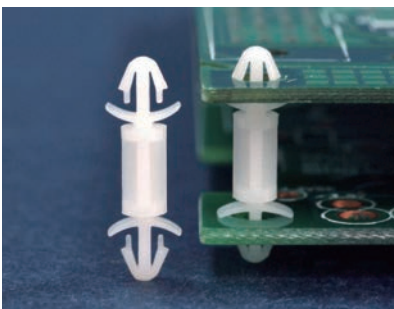

MOUNTING HOLE $\varnothing 3.0$
THICKNESS 1.2-2.0

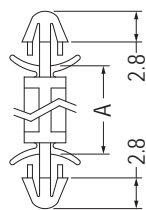

MOUNTING HOLE $\varnothing 3.0$
THICKNESS 1.2-2.0

MOUNTING HOLE $\varnothing 3.0$
THICKNESS 1.2-2.0

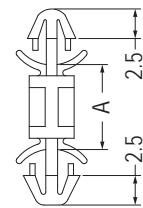

MOUNTING HOLE $\varnothing 3.5$
THICKNESS 1.6-2.0

Part No.	A	Package
LCF-3	3.2	1000
LCF-4	4.0	
LCF-5	5.0	
LCF-6S	6.0	
LCF-6	6.35	
LCF-7	7.0	
LCF-8	8.0	
LCF-9	9.5	
LCF-10.6	10.6	

Part No.	A	Package
LCF-11	11.2	1000
LCF-12	12.0	
LCF-14.4	14.4	
LCF-15	15.0	
LCF-16	16.0	
LCF-17	17.0	
LCF-20	20.2	
LCF-22	22.0	
LCF-25	25.4	

Part No.	A	Package
LCFO-3	3.0	1000
LCFO-3.5	3.5	
LCFO-4	4.0	
LCFO-4.8	4.8	
LCFO-6	6.0	
LCFO-6.4	6.4	
LCFO-7	7.0	
LCFO-8	8.0	
LCFO-9	9.0	
LCFO-10	10.0	
LCFO-11.5	11.5	
LCFO-12.7	12.7	
LCFO-14	14.0	
LCFO-16	16.0	

- Material: Nylon 66 (UL)
- Flame Class: 94V-2/94V-0
- Color: Natural/Black
- Unit: mm

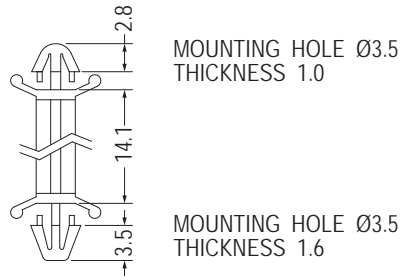
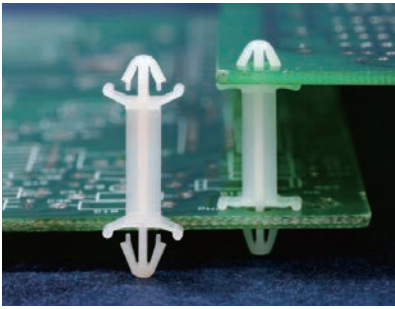

Part No.	Package
CBCS-14	1000

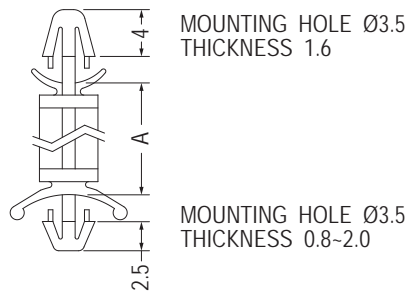
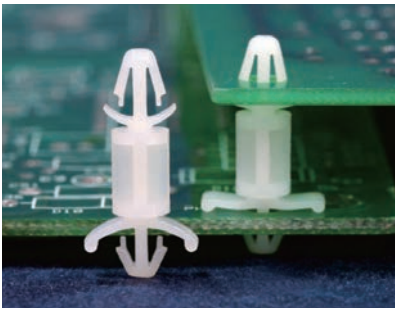

Part No.	A	Package
LCD-3	3.2	2000
LCD-4	4.0	
LCD-5	4.8	1000
LCD-6	6.4	
LCD-7	7.0	
LCD-8	8.0	
LCD-9	9.6	
LCD-11	11.2	
LCD-12	12.7	
LCD-14	14.0	
LCD-16	16.0	
LCD-18	18.0	
LCD-19	19.1	
LCD-27	27.5	

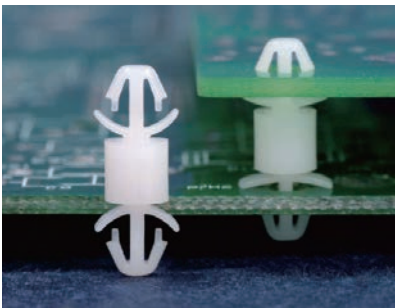

MOUNTING HOLE Ø3.5
THICKNESS 1.6-2.0

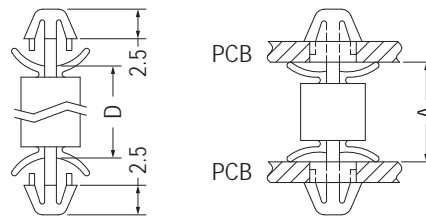

Part No.	A	D	Package
LCO-5	5.0	3.6	1000
LCO-6.4	6.4	5.0	
LCO-8	8.0	6.6	

MOUNTING HOLE Ø3.5
THICKNESS 1.6-2.0

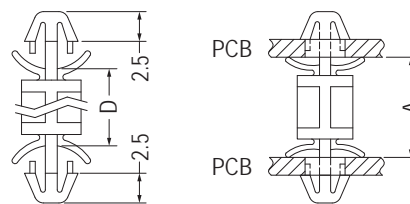

MOUNTING HOLE Ø3.5
THICKNESS 1.6-2.0

Part No.	A	D	Package
LCO-10	10.0	8.6	1000
LCO-11	11.0	9.6	
LCO-12.7	12.7	11.3	
LCO-15.9	15.9	14.5	

MOUNTING HOLE Ø3.5
THICKNESS 2.0-2.5

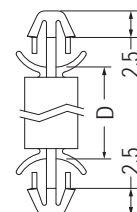

MOUNTING HOLE Ø3.5
THICKNESS 2.0-2.5

Part No.	D	Package
LCO-10L	10.1	1000
LCO-10.5L	10.5	

PCB間隔柱 PCB SPACER

用途：PC板與PC板間之固定，不佔空間。

1

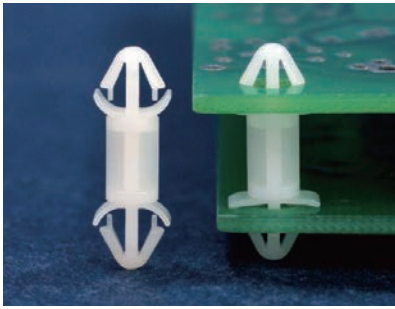

- Material: Nylon 66 (UL)
- Flame Class: 94V-2/94V-0
- Color: Natural/Black
- Unit: mm

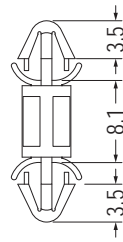

MOUNTING HOLE $\varnothing 4.0$
THICKNESS 1.6

MOUNTING HOLE $\varnothing 4.0$
THICKNESS 1.6

Part No.	Package
LCFB-8	1000

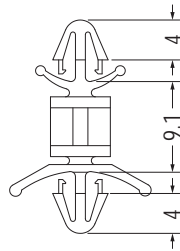
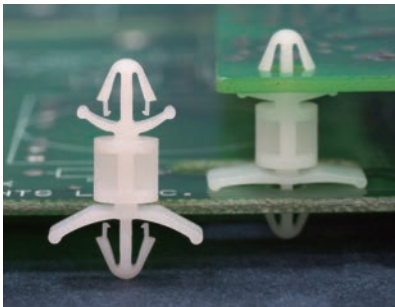

MOUNTING HOLE $\varnothing 4.0$
THICKNESS 1.6

MOUNTING HOLE $\varnothing 4.0$
THICKNESS 1.6

Part No.	Package
LCBJ-9	1000

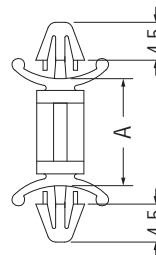
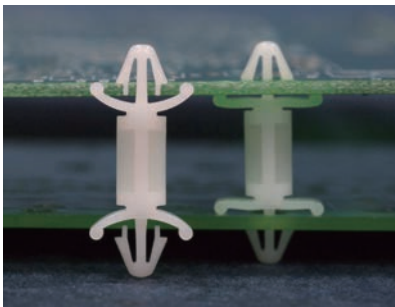

MOUNTING HOLE $\varnothing 4.0$
THICKNESS 0.8-1.7

MOUNTING HOLE $\varnothing 4.0$
THICKNESS 0.8-1.7

Part No.	A	Package
LCTA-4.8	4.8	2000
LCTA-12.7	12.7	1000

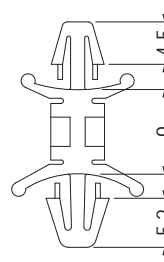
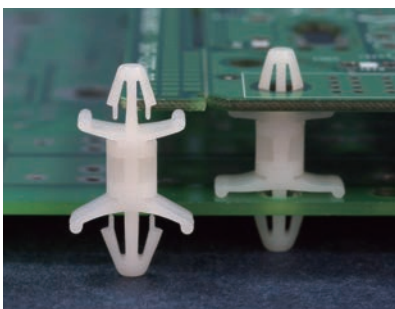

MOUNTING HOLE $\varnothing 4.0$
THICKNESS 0.8-2.0

MOUNTING HOLE $\varnothing 4.5$
THICKNESS 0.8-2.0

Part No.	Package
LCT-9	1000

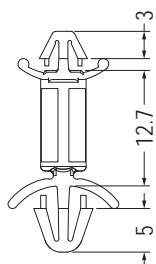
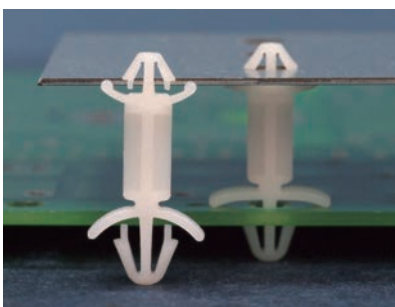

MOUNTING HOLE $\varnothing 4.0$
THICKNESS 1.0

MOUNTING HOLE $\varnothing 4.8$
THICKNESS 1.6

Part No.	Package
LCBD-12.7	1000

PCB間隔柱 PCB SPACER

用途：PC板與PC板間之固定，不佔空間。

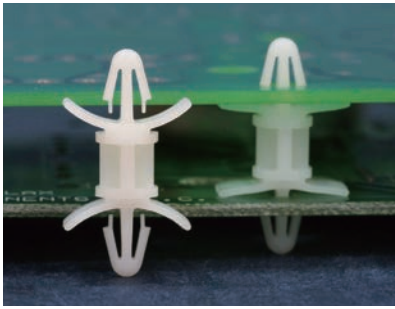

- Material: Nylon 66 (UL)
- Flame Class: 94V-2/94V-0
- Color: Natural/Black
- Unit: mm

MOUNTING HOLE Ø4.0
THICKNESS: T

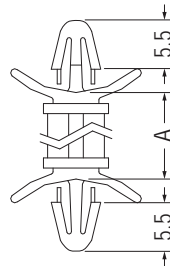

MOUNTING HOLE Ø4.0
THICKNESS: T

Part No.	A	T	Package
LCEO-5	4.8	0.8-2.0	1000
LCEO-6	6.4	0.8-2.0	
LCEO-8	7.9	0.8-2.0	
LCEO-9	9.5	0.8-2.0	
LCEO-12	12.7	0.8-2.0	
LCEO-12L	11.9	1.2-2.3	
LCEO-15	15.9	0.8-2.0	
LCEO-19	19.0	0.8-2.0	
LCEO-22	22.2	0.8-2.0	

MOUNTING HOLE Ø4.0
THICKNESS 1.6-2.0

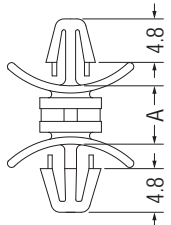

MOUNTING HOLE Ø4.8
THICKNESS 0.8-2.0

Part No.	A	Package
LCBZ-4.8	4.8	1000
LCBZ-6.4	6.4	

MOUNTING HOLE Ø4.75
THICKNESS 1.6

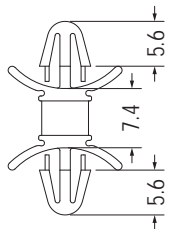

MOUNTING HOLE Ø4.75
THICKNESS 1.6

Part No.	Package
★LCBF-7.4	1000

MOUNTING HOLE Ø4.8
THICKNESS 0.8-2.0

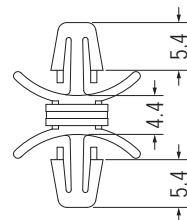

MOUNTING HOLE Ø4.8
THICKNESS 0.8-2.0

Part No.	Package
LCBYR-4.8	1000

MOUNTING HOLE Ø4.8
THICKNESS 0.8-2.0

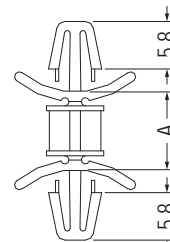

MOUNTING HOLE Ø4.8
THICKNESS 0.8-2.0

Part No.	A	Package
LCBY-4.8	4.8	1000
LCBY-6.4	6.4	
LCBY-9.5	9.5	
LCBY-12.7	12.7	
LCBY-15.9	15.9	
LCBY-19.1	19.1	
LCBY-22.2	22.2	

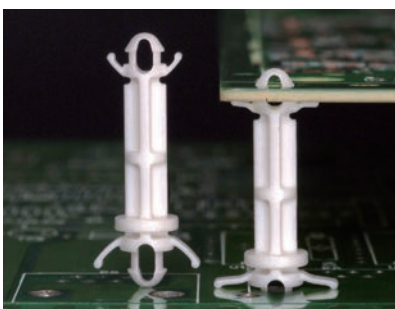

MOUNTING HOLE Ø3.0
THICKNESS 0.8

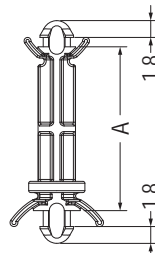

MOUNTING HOLE: ØG
THICKNESS: T



Part No.	A	G	T	Package
MADP-17.5	17.5	3.0	1.5	1000
MADP-20S	19.6	4.0	1.2	

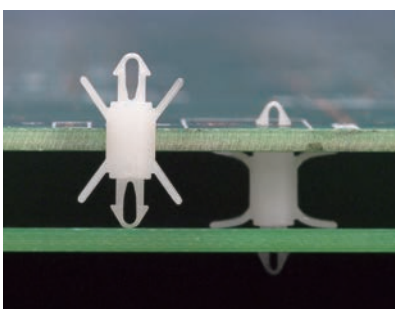

MOUNTING HOLE Ø2.0
THICKNESS 0.8-1.6

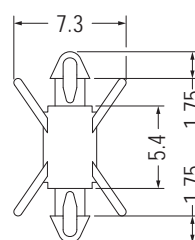

MOUNTING HOLE Ø2.0
THICKNESS 0.8-1.6

Part No.	Package
MADG-5.4	2000

PCB間隔柱 PCB SPACER

用途：PC板與PC板間之固定，不佔空間。

- Material: Nylon 66 (UL)
- Flame Class: 94V-2/94V-0
- Color: Natural/Black
- Unit: mm

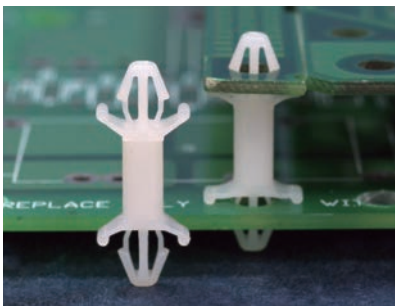
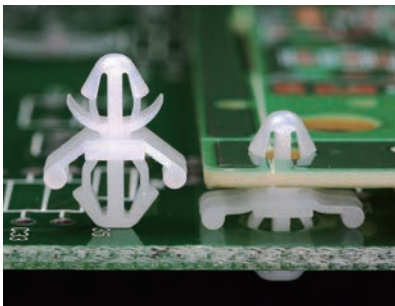
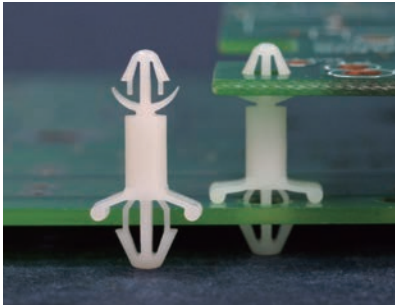
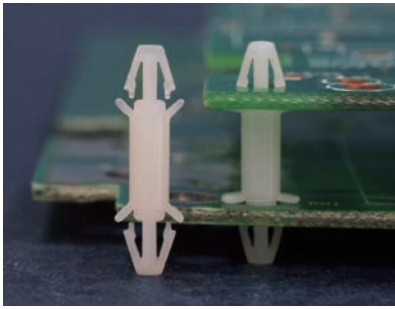

MOUNTING HOLE $\varnothing 3.0$
THICKNESS 1.6

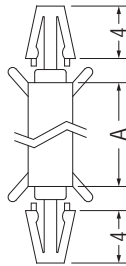

MOUNTING HOLE $\varnothing 3.0$
THICKNESS 1.6

Part No.	A	Package
LCA-6	6.3	1000
LCA-8	8.0	
LCA-10	10.0	
LCA-11	11.0	
LCA-12	12.7	

MOUNTING HOLE $\varnothing 3.0$
THICKNESS 0.8-2.0

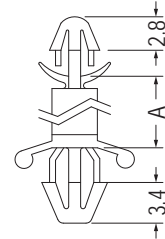

MOUNTING HOLE $\varnothing 4.0$
THICKNESS 1.2-2.6

Part No.	A	Package
LCH-3	3.5	1000
LCH-4	4.0	
LCH-5	5.0	
LCH-6	6.3	
LCH-7	7.4	
LCH-8	8.5	
LCH-10	10.0	
LCH-11	11.0	
LCH-12	12.7	
LCH-15	15.9	

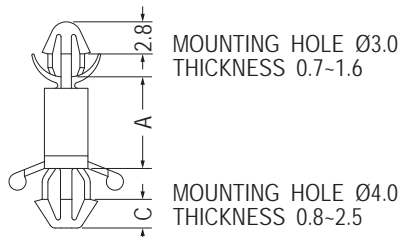

MOUNTING HOLE $\varnothing 3.0$
THICKNESS 0.7-1.6

MOUNTING HOLE $\varnothing 4.0$
THICKNESS 0.8-2.5

Part No.	A	C	Package
★LCH-3.3S	3.3	2.2	1000
★LCH-6.3S	6.3	2.2	
LCH-8S	8.0	2.5	
LCH-10S	10.0	2.5	
LCH-15S	13.0	2.5	

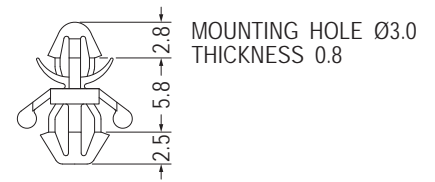

MOUNTING HOLE $\varnothing 3.0$
THICKNESS 0.8

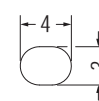

MOUNTING HOLE
THICKNESS 1.0



Part No.	Package
LCHA-2.3	1000

MOUNTING HOLE $\varnothing 3.5$
THICKNESS 0.8-2.0

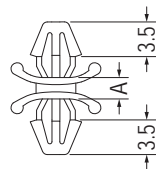

MOUNTING HOLE $\varnothing 3.5$
THICKNESS 0.8-2.0

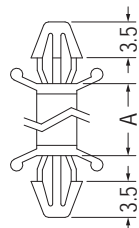

MOUNTING HOLE $\varnothing 3.5$
THICKNESS 0.8-2.0

【CBSS-2S】

Part No.	A	Package
CBSS-2	2.1	2000
CBSS-2S	2.1	
CBSS-2.2	2.2	
CBSS-4.8	4.8	

MOUNTING HOLE $\varnothing 3.5$
THICKNESS 0.8-2.0

Part No.	A	Package
CBSS-7	7.0	2000
CBSS-10	10.0	
CBSS-12.7	12.7	
CBSS-14	14.0	
CBSS-17	17.0	

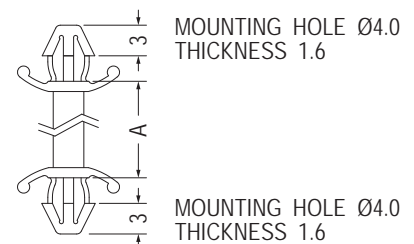

MOUNTING HOLE $\varnothing 4.0$
THICKNESS 1.6

MOUNTING HOLE $\varnothing 4.0$
THICKNESS 1.6

Part No.	A	Package
CBLSS-6	4.2	1000
CBLSS-8	6.2	
CBLSS-10	8.2	
CBLSS-12	10.2	
CBLSS-13	11.2	
CBLSS-14	12.2	
CBLSS-16	14.2	
CBLSS-16.8	15.0	
CBLSS-18	16.2	
CBLSS-20	18.2	
CBLSS-42	40.2	

PCB間隔柱 PCB SPACER

用途：固定PC板於機板上，免工具易拆卸。

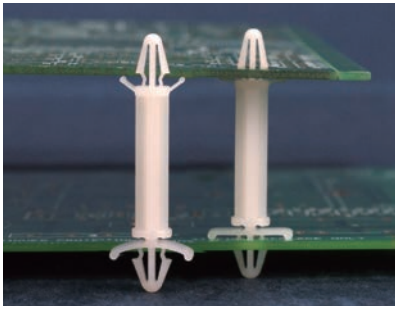

- Material: Nylon 66 (UL)
- Flame Class: 94V-2/94V-0
- Color: Natural/Black
- Unit: mm

MOUNTING HOLE Ø4.0
THICKNESS 0.8-1.7

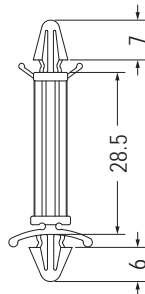

MOUNTING HOLE Ø4.8
THICKNESS 0.8-1.7

Part No.	Package
LCBSA-28.5	500

MOUNTING HOLE Ø4.0
THICKNESS 0.8-1.7

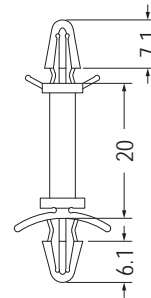

MOUNTING HOLE Ø4.8
THICKNESS 1.8-2.7

Part No.	Package
LCBSA-20L	500

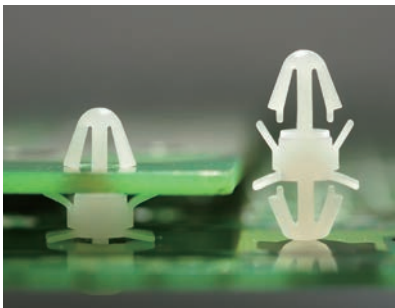

- Material: Nylon 66 (UL)
- Flame Class: 94V-2/94V-0
- Color: Natural/Black
- Unit: mm

用途：PC板與PC板間之固定，不佔空間。

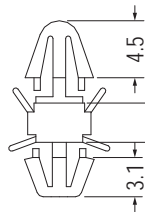

MOUNTING HOLE Ø4.0
THICKNESS 1.6

MOUNTING HOLE Ø4.0
THICKNESS 0.8

Part No.	Package
LCL-3.2	2000

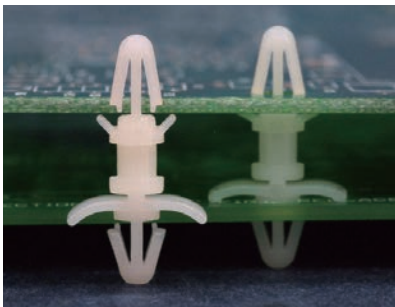

- Material: Nylon 66 (UL)
- Flame Class: 94V-2/94V-0
- Color: Natural/Black
- Unit: mm

用途：固定PC板於機板上，免工具易拆卸。

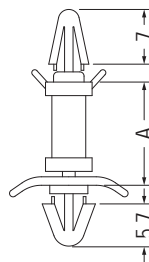

MOUNTING HOLE Ø4.0
THICKNESS 1.6

MOUNTING HOLE Ø4.8
THICKNESS 0.8-2.0

Part No.	A	Package
LCB-5	5.0	1000
LCB-6	6.3	
LCB-8	8.0	
LCB-10	10.0	
LCB-12	12.7	
LCB-15	15.9	
LCB-20	20.0	
LCB-25	25.0	

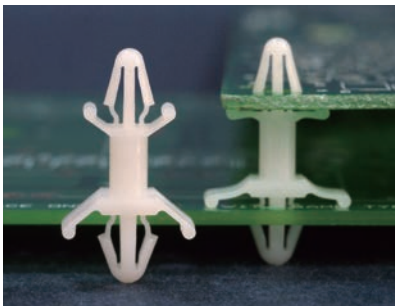

MOUNTING HOLE Ø4.0
THICKNESS 1.6

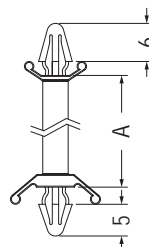

MOUNTING HOLE Ø4.0
THICKNESS 0.8-2.2

MOUNTING HOLE Ø4.0
THICKNESS 1.6

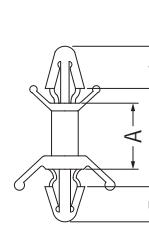

MOUNTING HOLE Ø4.8
THICKNESS 0.8-2.2

【 CBSB-45 】

Part No.	A	Package
CBS-3.8	3.8	1000
CBS-5	4.6	
CBS-6	6.3	
CBS-8	7.93	
CBS-9	9.2	
CBS-12	12.5	
CBS-15	15.7	
CBS-19	19.0	
CBS-22	22.0	
CBS-25	25.4	
CBS-28	28.6	
CBSB-45	45.0	

PCB間隔柱 PCB SPACER

用途：固定PC板於機板上，免工具易拆卸。

1

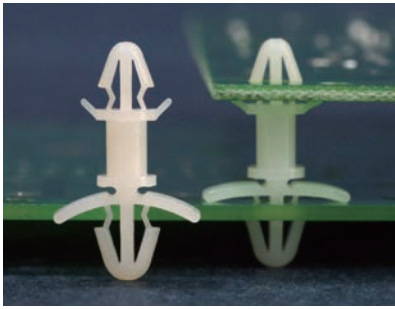

- Material: Nylon 66 (UL)
- Flame Class: 94V-2/94V-0
- Color: Natural/Black
- Unit: mm

MOUNTING HOLE Ø4.0
THICKNESS 1.6

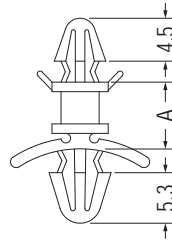

MOUNTING HOLE Ø4.8
THICKNESS 0.8-2.2

Part No.	A	Package
LCBS-4	4.0	1000
LCBS-5	5.0	
LCBS-6	6.35	
LCBS-7	7.0	
LCBS-9	9.2	
LCBS-10	10.0	
LCBS-12	12.5	
LCBS-15	15.7	
LCBS-19	19.0	
LCBS-20	20.0	
LCBS-22	22.0	
LCBS-25	25.4	
LCBS-28	28.6	
LCBS-30	30.0	
LCBS-35	35.0	
LCBS-38	38.0	
LCBS-45	45.0	

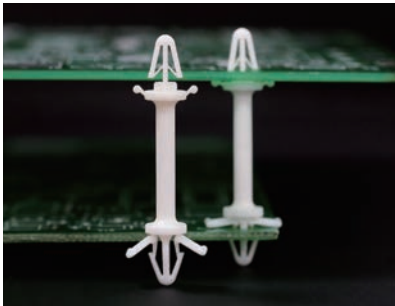

MOUNTING HOLE Ø4.0
THICKNESS 1.6

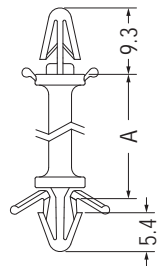

MOUNTING HOLE Ø4.8
THICKNESS 2.0

Part No.	A	Package
LCBB-6.35	6.35	1000
LCBB-9.5	9.5	
LCBB-12.7	12.7	
LCBB-15.9	15.87	
★LCBB-19	19.05	
LCBB-22.2	22.22	
LCBB-25.4	25.4	

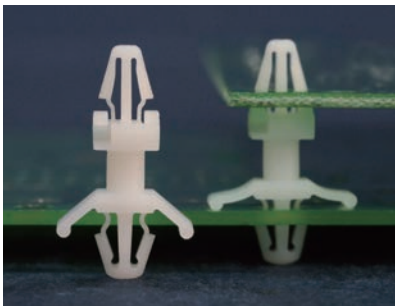

MOUNTING HOLE Ø4.0
THICKNESS 1.2-2.0

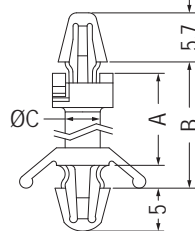

MOUNTING HOLE Ø4.8
THICKNESS 0.8-2.0

Part No.	A	B	C	Package
VCBS-9	5.9	9.8	/	1000
VCBS-11	7.5	11.4	4.0	
VCBS-14	10.5	14.4	4.0	
VCBS-16	12.7	16.6	4.0	
VCBS-17	13.8	17.7	4.0	
VCBS-20	17.0	20.9	4.0	
VCBS-24	20.2	24.1	4.5	
VCBS-27	23.3	27.2	4.5	
VCBS-30	26.5	30.4	4.5	
VCBS-33	29.7	33.6	4.5	
VCBS-39	36.0	39.9	4.5	

MOUNTING HOLE Ø4.0
THICKNESS 1.2-2.0

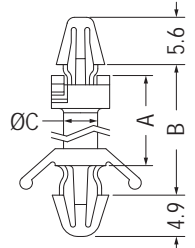

MOUNTING HOLE Ø4.8
THICKNESS 0.8-3.0

Part No.	A	B	C	Package
VCBSL-9	5.0	9.8	/	1000
VCBSL-11	6.6	11.4	4.0	
VCBSL-14	9.6	14.4	4.0	
VCBSL-16	11.8	16.6	4.0	
VCBSL-17	12.9	17.7	4.0	
VCBSL-24	19.3	24.1	4.5	
VCBSL-27	22.4	27.2	4.5	
VCBSL-30	25.6	30.4	4.5	
VCBSL-33	28.8	33.6	4.5	
VCBSL-39	35.1	39.9	4.5	

PCB間隔柱 PCB SPACER

用途：固定PC板於機板上，免工具易拆卸。

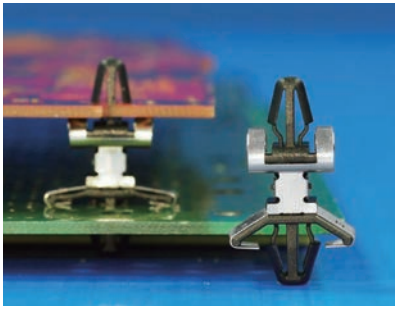

- Material: Nylon 66 (UL)
- Flame Class: 94V-2/94V-0
- Color: Natural/Black
- Unit: mm

MOUNTING HOLE $\varnothing 4.0$
THICKNESS 1.6-2.0

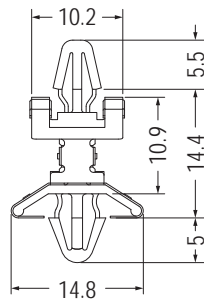

MOUNTING HOLE $\varnothing 4.8$
THICKNESS 1.0-2.0

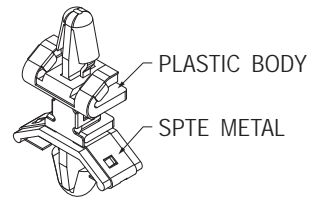

Part No.	Part No.	Package
VCBA-14.4F	VCBA-14.4ST	1000
	VCBA-14.4	

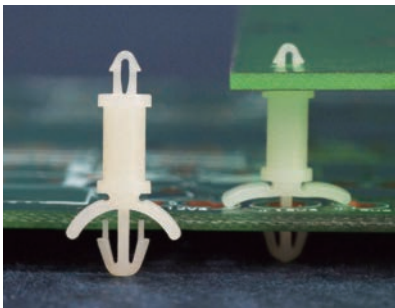

MOUNTING HOLE $\varnothing 2.0$
THICKNESS 1.6

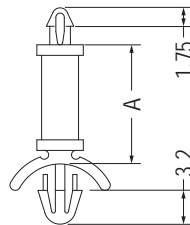

MOUNTING HOLE $\varnothing 3.0$ - $\varnothing 3.2$
THICKNESS 0.8-2.0

Part No.	A	Package
LCMA-3.2	3.2	1000
LCMA-4.8	4.8	
LCMA-6.4	6.4	
LCMA-7.9	7.9	
LCMA-9.5	9.5	
LCMA-11.1	11.1	
LCMA-12.7	12.7	
LCMA-14.3	14.3	
LCMA-15.9	15.9	
LCMA-17	17.0	

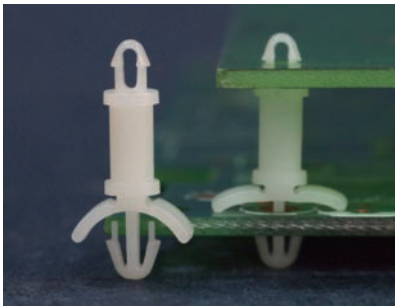

MOUNTING HOLE $\varnothing 2.5$
THICKNESS 1.6

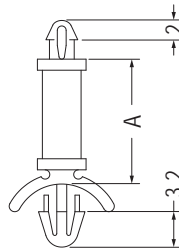

MOUNTING HOLE $\varnothing 3.0$ - $\varnothing 3.2$
THICKNESS 0.8-2.0

Part No.	A	Package
LCMD-3.2	3.2	1000
LCMD-4.8	4.8	
LCMD-6.4	6.4	
LCMD-7.9	7.9	
LCMD-9.5	9.5	
LCMD-11.1	11.1	
LCMD-12.7	12.7	
LCMD-14.3	14.3	
LCMD-15.9	15.9	
LCMD-17	17.0	

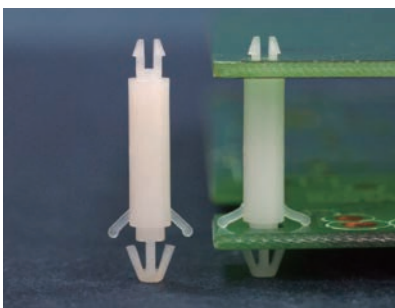

- Material: Nylon 66 (UL)
- Flame Class: 94V-2/94V-0
- Color: Natural/Black
- Unit: mm

用途：PC板與PC板間之固定，不佔空間。

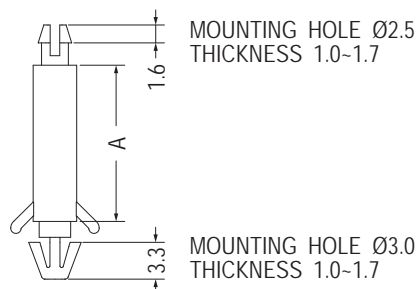

MOUNTING HOLE $\varnothing 2.5$
THICKNESS 1.0-1.7

MOUNTING HOLE $\varnothing 3.0$
THICKNESS 1.0-1.7

Part No.	A	Package
LCAB-12	12.0	1000
LCAB-14	14.0	

PCB間隔柱 PCB SPACER

用途：固定PC板於機板上，免工具易拆卸。

1

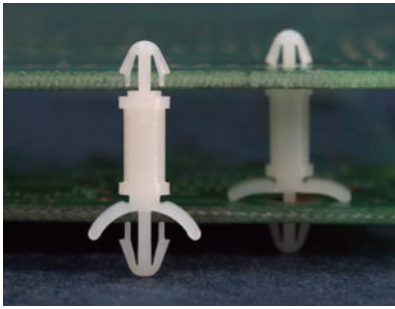

- Material: Nylon 66 (UL)
- Flame Class: 94V-2/94V-0
- Color: Natural/Black
- Unit: mm

MOUNTING HOLE Ø3.0
THICKNESS 1.2-1.7

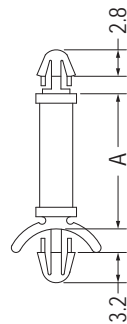

MOUNTING HOLE Ø3.0
THICKNESS 0.8-2.0

Part No.	A	Package
LCG-3	3.2	1000
LCG-5	4.8	
LCG-6	6.4	
LCG-8	7.9	
LCG-9	9.5	
LCG-11	11.1	
LCG-12	12.7	
LCG-14	14.3	
LCG-15	15.9	
LCG-17	17.0	
LCG-18	18.0	
LCG-19	19.0	
LCG-20	20.0	
LCG-26	26.0	

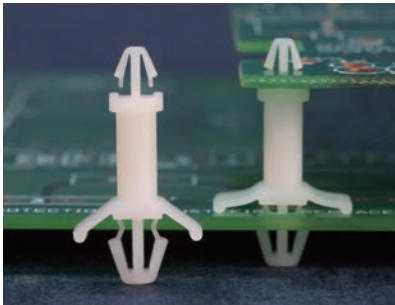

MOUNTING HOLE Ø3.0
THICKNESS 1.2-1.7

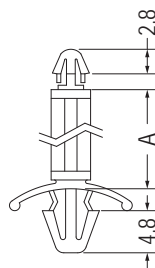

MOUNTING HOLE Ø3.5
THICKNESS 1.2-1.7

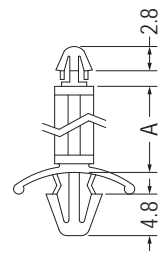

MOUNTING HOLE Ø3.0
THICKNESS 1.4-1.6

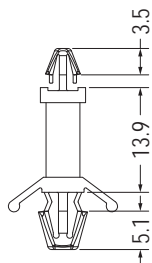

MOUNTING HOLE Ø4.8-Ø5.0
THICKNESS 0.8-2.0

Part No.	Package
LCBUA-13.9	1000

MOUNTING HOLE Ø4.8
THICKNESS 0.8-2.2

Part No.	A	Package
LCBT-3	3.2	1000
LCBT-5	4.8	
LCBT-6	6.3	
LCBT-8	8.0	
LCBT-10	10.0	
LCBT-12	12.0	
LCBT-14	14.0	
LCBT-16	16.0	
LCBT-18	18.0	
LCBT-25	25.0	

MOUNTING HOLE Ø4.8
THICKNESS 0.8-2.2

Part No.	A	Package
LCBU-3	3.2	1000
LCBU-5	5.0	
LCBU-6	6.3	
LCBU-8	8.0	
LCBU-10	10.0	
LCBU-12	12.0	
LCBU-14	14.0	
LCBU-16	16.0	
LCBU-18	18.0	
LCBU-25	25.0	

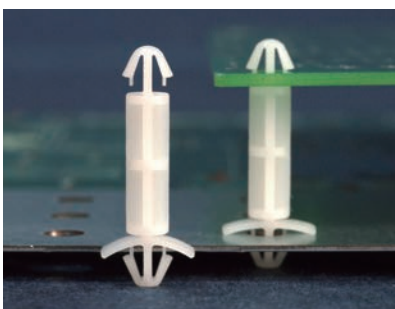

MOUNTING HOLE Ø4.0
THICKNESS 1.6

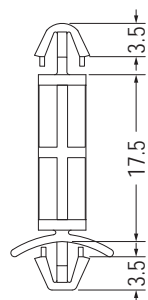

MOUNTING HOLE Ø4.0
THICKNESS 0.5-1.2

Part No.	Package
LCGB-17.5	1000

PCB間隔柱 PCB SPACER

用途：固定PC板於機板上，免工具易拆卸。

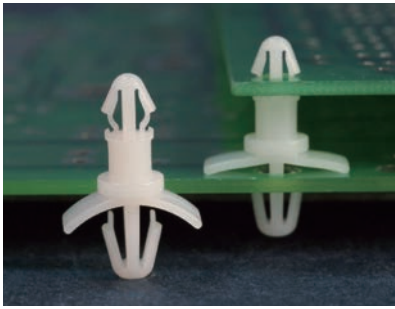

- Material: Nylon 66 (UL)
- Flame Class: 94V-2/94V-0
- Color: Natural/Black
- Unit: mm

MOUNTING HOLE Ø4.0
THICKNESS 1.6

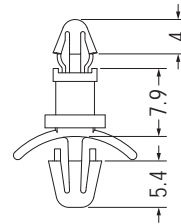

MOUNTING HOLE Ø4.8
THICKNESS 0.8-2.0

Part No.	Package
LCBC-8	1000

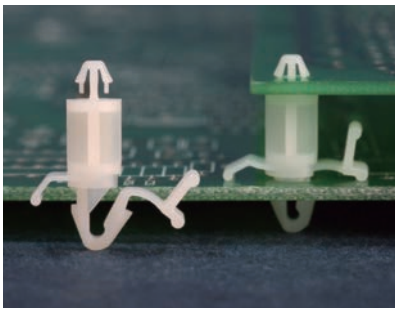

- Material: Nylon 66 (UL)
- Flame Class: 94V-2/94V-0
- Color: Natural/Black
- Unit: mm

用途：PC板與PC板間之固定，不佔空間，可在板上拆卸。

MOUNTING HOLE Ø3.0
THICKNESS 1.6

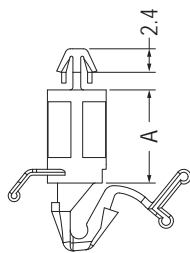

MOUNTING HOLE Ø4.8
THICKNESS 0.8-1.6

Part No.	A	Package
KLCBS-9.5	9.5	1000
KLCBS-12.7	12.7	
KLCBS-15.9	15.9	
KLCBS-19.1	19.1	

MOUNTING HOLE Ø3.5
THICKNESS 1.6

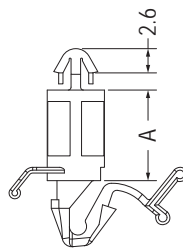

MOUNTING HOLE Ø4.8
THICKNESS 0.8-1.6

Part No.	A	Package
KLCBM-9.5	9.5	1000
KLCBM-12.7	12.7	
KLCBM-15.9	15.9	
KLCBM-19.1	19.1	

MOUNTING HOLE Ø4.0
THICKNESS 1.6

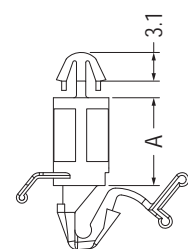

MOUNTING HOLE Ø4.8
THICKNESS 0.8-1.6

Part No.	A	Package
KLCBL-9.5	9.5	1000
KLCBL-12.7	12.7	
KLCBL-15.9	15.9	
KLCBL-19.1	19.1	

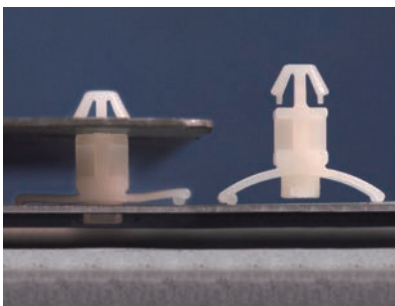

- Material: Nylon 66 (UL)
- Flame Class: 94V-2/94V-0
- Color: Natural/Black
- Unit: mm

MOUNTING HOLE Ø4.0
THICKNESS 1.0

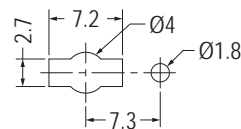
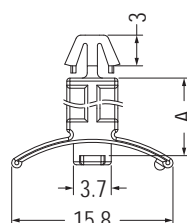

MOUNTING HOLE
THICKNESS 0.6-1.0

Part No.	A	Package
LCBA-5.6	5.6	1000
LCBA-7.6	7.6	

PCB間隔柱 PCB SPACER

用途：固定PC板於機板上，免工具易拆卸。

- Material: Nylon 66 (UL)
- Flame Class: 94V-2/94V-0
- Color: Natural/Black
- Unit: mm

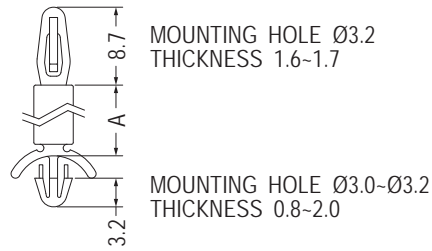
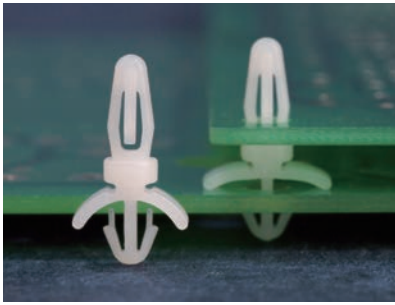

Part No.	A	Package
LCSE-3.2	3.2	1000
LCSE-4.8	4.8	
LCSE-6.4	6.4	
LCSE-7.9	7.9	
LCSE-9.5	9.5	
LCSE-11.1	11.1	
LCSE-12.7	12.7	
LCSE-14.3	14.3	
LCSE-15.9	15.9	
LCSE-17	17.0	

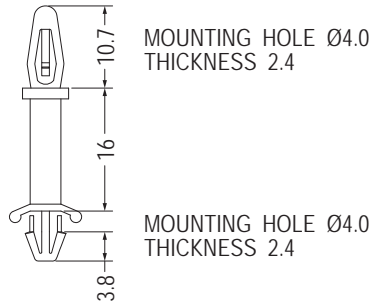
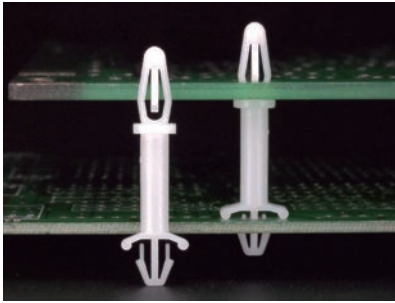

Part No.	Package
LCSJ-16	1000

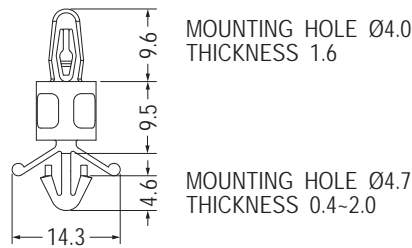
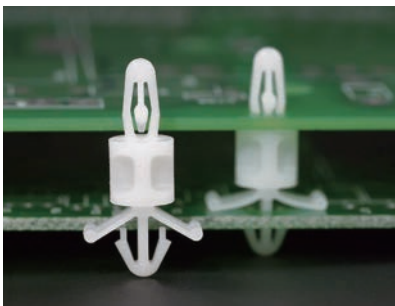

Part No.	Package
LCSH-9.5	1000

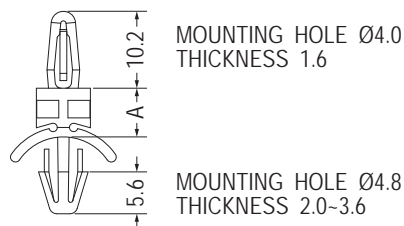
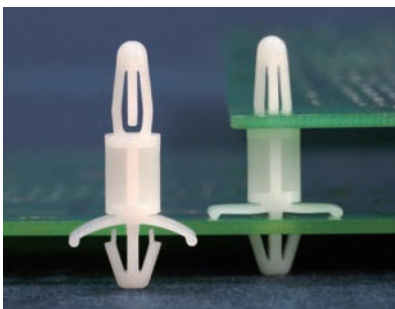

Part No.	A	Package
LCSA-6.4	6.4	1000
LCSA-9.5	9.5	

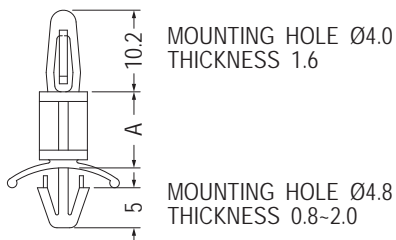

Part No.	A	Package
LCS-3	3.5	1000
LCS-5	4.8	
LCS-6	6.0	
LCS-6A	6.4	
LCS-8	7.9	
LCS-9	9.5	

Part No.	A	Package
LCS-11	11.1	1000
LCS-12	12.7	
LCS-16	15.9	
LCS-19	19.1	
LCS-22	22.2	
LCS-24	24.0	
LCS-25	25.4	
LCS-27.5	27.5	
LCS-28	28.6	
LCS-31.1	31.1	
LCS-31.7	31.7	
LCS-35	34.9	

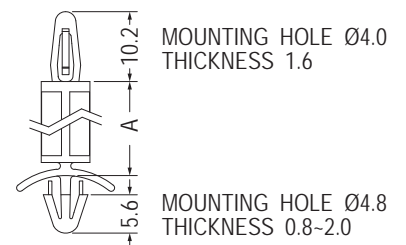

Part No.	A	Package
HLCS-4.8	4.8	1000
HLCS-6.4	6.4	
HLCS-9.5	9.5	
HLCS-12.7	12.7	
HLCS-15.9	15.9	
HLCS-25.4	25.4	
HLCS-40	40.0	
HLCS-49	49.0	

PCB間隔柱 PCB SPACER

用途：固定PC板於機板上，免工具易拆卸。

- Material: Nylon 66 (UL)
- Flame Class: 94V-2/94V-0
- Color: Natural/Black
- Unit: mm

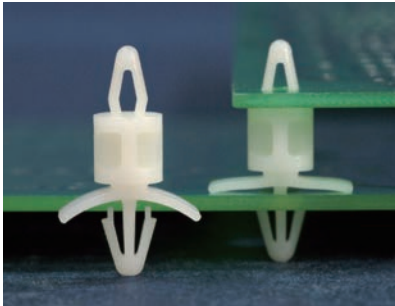
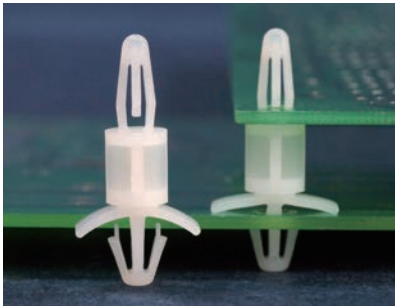

MOUNTING HOLE Ø4.0
THICKNESS 2.4

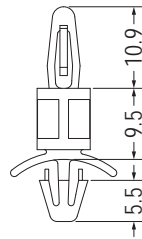

MOUNTING HOLE Ø4.8
THICKNESS 1.6

Part No.	Package
LCSLR-9.5	1000

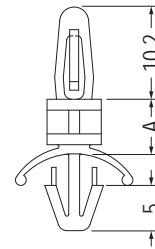

MOUNTING HOLE Ø4.0
THICKNESS: T

MOUNTING HOLE Ø4.8
THICKNESS 2.0-3.2

Part No.	A	T	Package
LCSD-4.8	4.8	1.6	1000
LCSD-9.5	9.5	1.6	
LCSD-12.7	12.7	1.6	
LCSL-4.8	4.8	2.0-3.2	

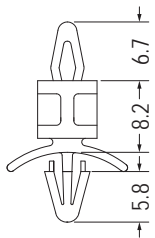

MOUNTING HOLE Ø3.5
THICKNESS 1.6

MOUNTING HOLE Ø4.0
THICKNESS 0.8-1.6

Part No.	Package
LCPA-8.2	1000

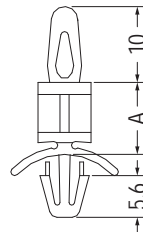

MOUNTING HOLE Ø4.0
THICKNESS 1.2-1.7

MOUNTING HOLE Ø4.8
THICKNESS 0.8-2.5

Part No.	A	Package
LCP-7.9	7.9	1000
LCP-9	9.5	
LCP-12.7	12.7	
LCP-22	22.2	

MOUNTING HOLE Ø4.0
THICKNESS 1.2-1.7

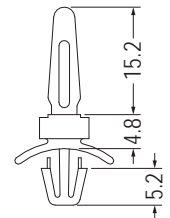

MOUNTING HOLE Ø4.8
THICKNESS 0.8-2.0

Part No.	Package
LCY-4.8	1000

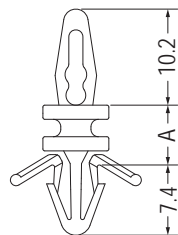
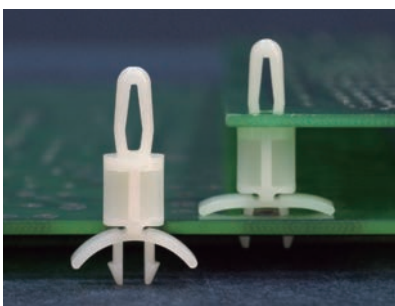
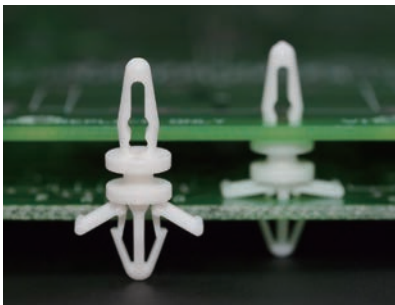

MOUNTING HOLE Ø4.0
THICKNESS 1.6

MOUNTING HOLE Ø4.8
THICKNESS 2.0

Part No.	A	Package
LCPD-6.35	6.35	1000
LCPD-9.5	9.52	
★LCPD-12.7	12.7	

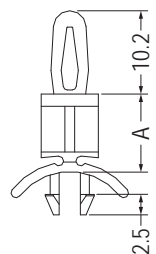

MOUNTING HOLE Ø4.0
THICKNESS 1.2-1.7

MOUNTING HOLE Ø4.8
THICKNESS 0.8-2.0

Part No.	A	Package
UCBS-5	4.8	1000
UCBS-6	6.4	
UCBS-9	9.5	
UCBS-12	12.7	
UCBS-15	15.9	
UCBS-19	19.1	
UCBS-22	22.2	

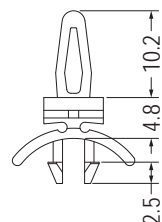

MOUNTING HOLE Ø3.8
THICKNESS 1.6

MOUNTING HOLE Ø4.8
THICKNESS 0.8-2.0

Part No.	Package
UCBS-5A	1000

PCB間隔柱 PCB SPACER

用途：固定PC板於機板上，免工具易拆卸。

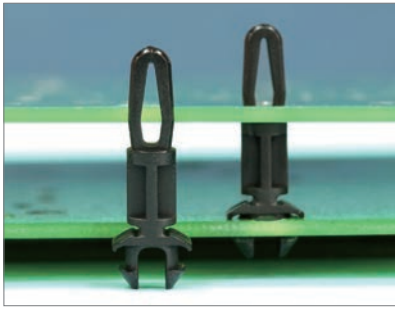

- Material: Nylon 66 (UL)
- Flame Class: 94V-2/94V-0
- Color: Natural/Black
- Unit: mm

MOUNTING HOLE Ø4.0
THICKNESS 1.2-1.7

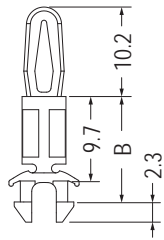

MOUNTING HOLE Ø5.4
THICKNESS: T

Part No.	B	T	Package
UCBSL-9	11.7	1.6	1000
UCBSL-10	12.0	2.2	

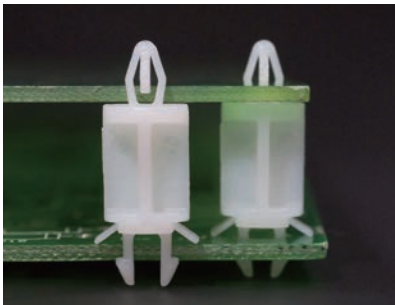

MOUNTING HOLE Ø3.3
THICKNESS 1.6

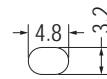
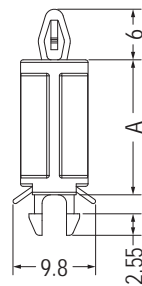

MOUNTING HOLE
THICKNESS 1.8-2.0

Part No.	A	Package
LMSD-12	12.0	1000
LMSD-16	16.0	

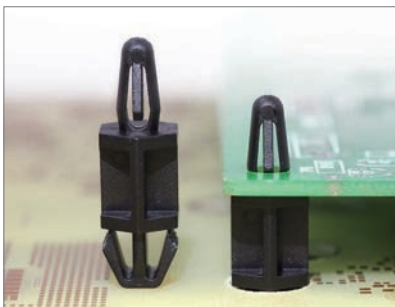

MOUNTING HOLE Ø4.0
THICKNESS 1.6

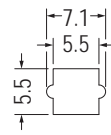
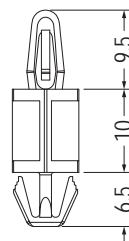

MOUNTING HOLE
THICKNESS 0.8-1.6

Part No.	Package
LCSI-10	1000

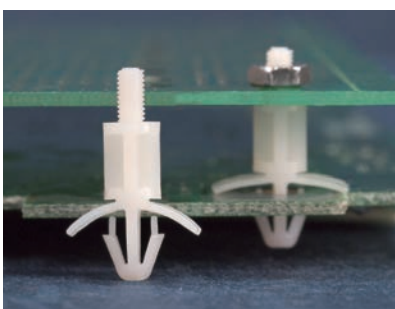

- Material: Nylon 66 (UL)
- Flame Class: 94V-2/94V-0
- Color: Natural/Black
- Unit: mm

用途：固定PC板於機板上，一頭配合螺母使用，不旋轉。

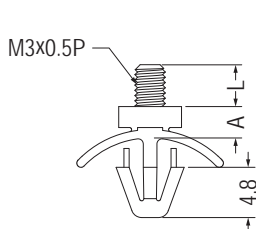

【 LCDS3-3, LCDS3-4 】

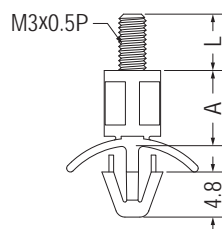

MOUNTING HOLE Ø4.8
THICKNESS 0.8-2.5

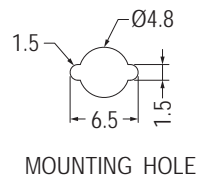

MOUNTING HOLE

Part No.	A	L	Package
LCDS3-3	3.0	4.0	1000
LCDS3-4	4.0	4.0	
LCDS3-5	5.0	4.0	
LCDS3-6	6.0	6.0	
LCDS3-7	7.0	6.0	
LCDS3-8	8.0	6.0	
LCDS3-9	9.0	6.0	
LCDS3-10	10.0	6.0	
LCDS3-11	11.0	6.0	
LCDS3-12	12.0	6.0	
LCDS3-13	13.0	6.0	
LCDS3-14	14.0	6.0	
LCDS3-15	15.0	6.0	

PCB間隔柱 PCB SPACER

用途：固定PC板於機板上，一頭配合螺母使用，不旋轉。

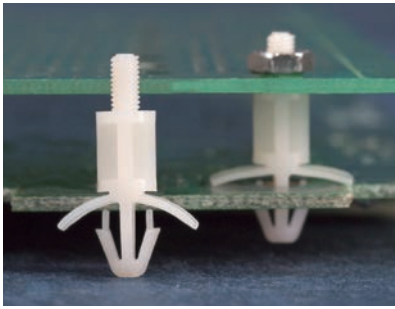

- Material: Nylon 66 (UL)
- Flame Class: 94V-2/94V-0
- Color: Natural/Black
- Unit: mm

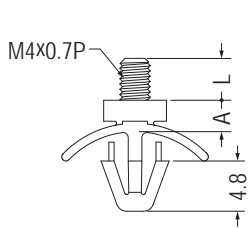

【 LCDS4-3, LCDS4-4 】

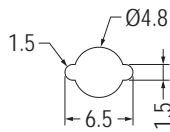
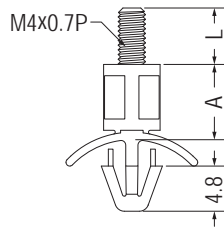

MOUNTING HOLE THICKNESS 0.8-2.5

Part No.	A	L	Package
LCDS4-3	3.0	4.0	1000
LCDS4-4	4.0	4.0	
LCDS4-5	5.0	4.0	
LCDS4-6	6.0	6.0	
LCDS4-7	7.0	6.0	
LCDS4-8	8.0	6.0	
LCDS4-9	9.0	6.0	
LCDS4-10	10.0	6.0	
LCDS4-11	11.0	6.0	
LCDS4-12	12.0	6.0	
LCDS4-13	13.0	6.0	
LCDS4-14	14.0	6.0	
LCDS4-15	15.0	6.0	

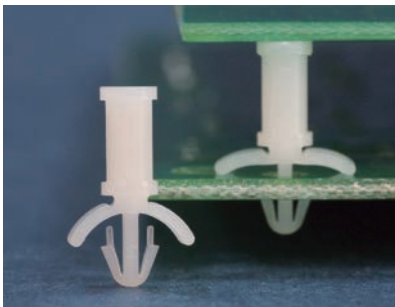

- Material: Nylon 66 (UL)
- Flame Class: 94V-2/94V-0
- Color: Natural/Black
- Unit: mm

用途：一端固定於機板上，另一端支撐PC板，避免下陷造成短路，PC板免鑽孔。

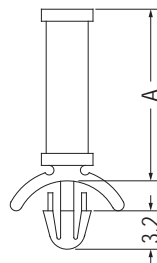

MOUNTING HOLE Ø3.0 THICKNESS 0.8-2.0

Part No.	A	Package
LBS-3	3.2	1000
LBS-5	4.8	
LBS-6	6.4	
LBS-8	7.9	
LBS-9	9.5	
LBS-11	11.1	
LBS-12	12.7	
LBS-14	14.3	
LBS-15	15.9	
LBS-17	17.0	
LBS-19	19.0	
LBS-20	20.0	
LBS-26	26.0	

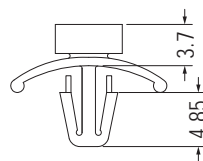
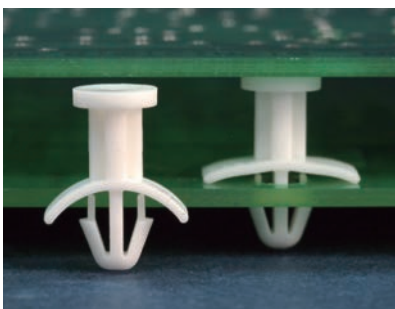

MOUNTING HOLE Ø4.0 THICKNESS 1.0-2.0

Part No.	Package
LASB-3.7	1000

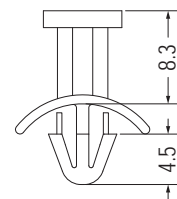

MOUNTING HOLE Ø4.5 THICKNESS 0.8-2.0

Part No.	Package
LASD-8.3	1000

PCB間隔柱 PCB SPACER

1

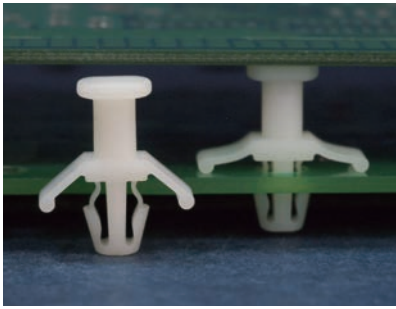

- Material: Nylon 66 (UL)
- Flame Class: 94V-2/94V-0
- Color: Natural/Black
- Unit: mm

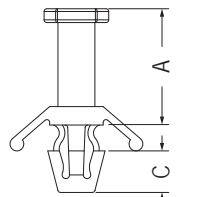

MOUNTING HOLE Ø4.8
THICKNESS: T

Part No.	A	C	T	Package
LASY-4.6	4.6	4.6	0.8~2.5	1000
LASY-9.3	9.3	4.5	0.5~2.3	
LASY-12.6	12.6	4.5	0.5~2.3	
LASY-15.9	15.9	4.5	0.5~2.3	

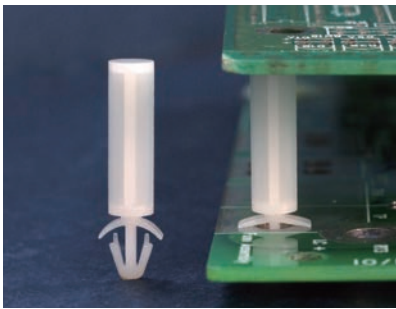
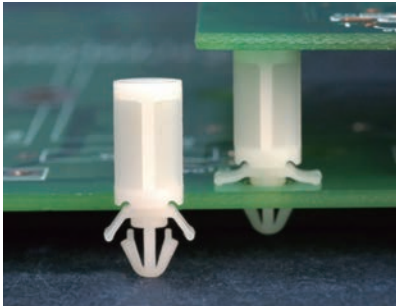

用途：一端固定於機板上，另一端支撐PC板，避免下陷造成短路，PC板免鑽孔。

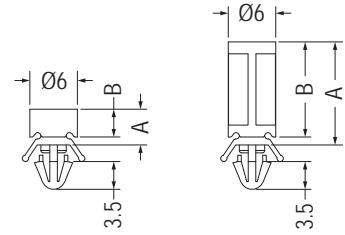

【LASE-4.5】 MOUNTING HOLE Ø3.5
THICKNESS 1.2-1.6

Part No.	A	B	Package
LASE-4.5	4.5	3.5	1000
LASE-7	7.0	6.0	
LASE-12	12.0	11.0	

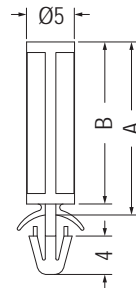

MOUNTING HOLE Ø3.5
THICKNESS 1.6

Part No.	A	B	Package
LASJ-17	17.0	15.9	1000
LASJ-18	18.0	16.9	
LASJ-20	20.0	18.9	

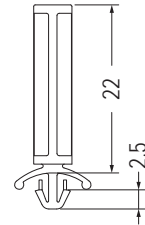

MOUNTING HOLE Ø3.5
THICKNESS 0.8-1.8

Part No.	Package
LASH-22	1000

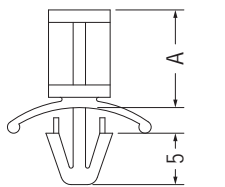

MOUNTING HOLE Ø4.8
THICKNESS 0.8-2.0

Part No.	A	Package
LAS-3	3.5	1000
LAS-5	4.8	
LAS-6	6.0	
LAS-6A	6.4	
LAS-8	7.9	
LAS-9	9.5	
LAS-11	11.1	
LAS-12	12.7	
LAS-16	15.9	

Part No.	A	Package
LAS-19	19.1	1000
LAS-22	22.2	
LAS-24	24.0	
LAS-25	25.4	
LAS-27.5	27.5	
LAS-28	28.6	500
LAS-31.1	31.1	
LAS-31.7	31.7	
LAS-35	34.9	

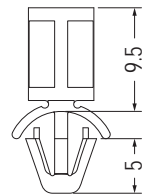

MOUNTING HOLE Ø4.8-Ø5.0
THICKNESS 0.8-2.0

Part No.	Package
LASA-9.5	1000

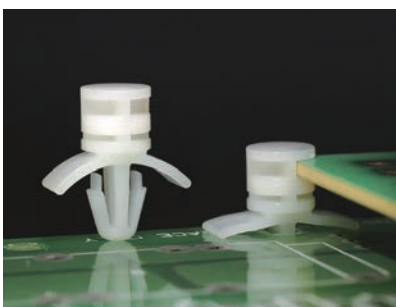

- Material: Nylon 66 (UL)
- Flame Class: 94V-2/94V-0
- Color: Natural/Black
- Unit: mm

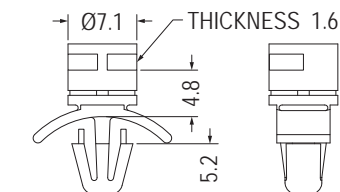
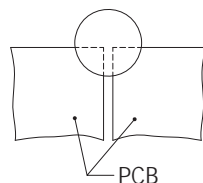

MOUNTING HOLE Ø4.8
THICKNESS 1.6

用途：一端固定於機板上，另一端讓PC板嵌入。

Part No.	Package
LASL-4.8	1000

PCB間隔柱 PCB SPACER

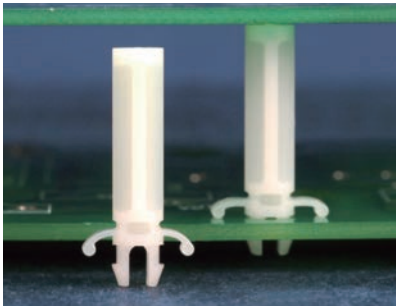

- Material: Nylon 66 (UL)
- Flame Class: 94V-2/94V-0
- Color: Natural/Black
- Unit: mm

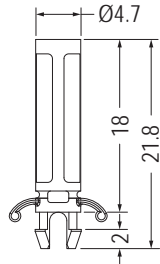

MOUNTING HOLE Ø4.0
THICKNESS 1.2-1.6

Part No.	Package
LASF-18	1000

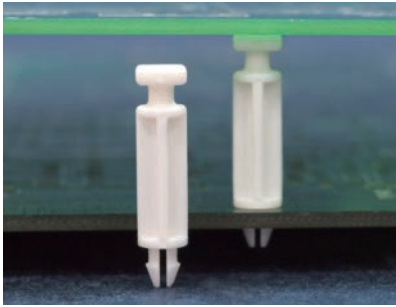

用途：一端固定於機板上，另一端支撐PC板，避免下陷造成短路，PC板免鑽孔。

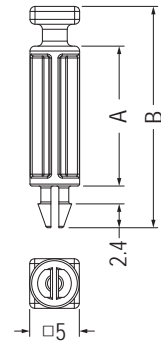

MOUNTING HOLE Ø3.0
THICKNESS 1.6

Part No.	A	B	Package
MSA-14.1	14.1	22.3	1000
MSA-24.3	24.3	32.5	

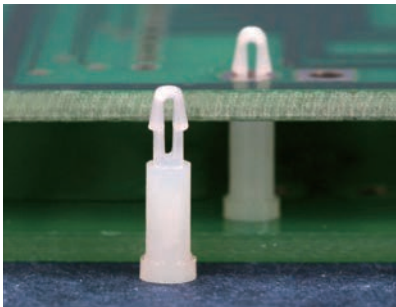

- Material: Nylon 66 (UL)
- Flame Class: 94V-2/94V-0
- Color: Natural/Black
- Unit: mm

MOUNTING HOLE Ø1.5
THICKNESS 1.0

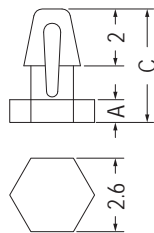

Part No.	A	C	Package
MASD-0.8	0.8	4.0	2000
MASD-2	2.0	5.2	

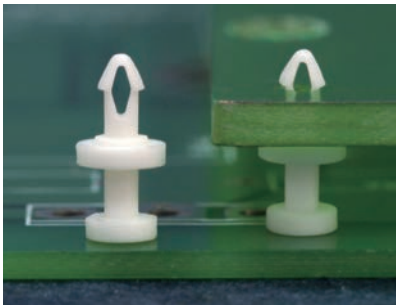

MOUNTING HOLE Ø1.5
THICKNESS 1.6

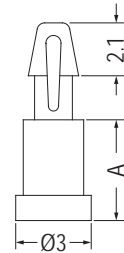

Part No.	A	Package
MASS-2	2.0	2000
MASS-2.5	2.5	
MASS-3	3.0	
MASS-3.5	3.5	
MASS-4	4.0	
MASS-5	5.0	
MASS-6	6.0	
MASS-6.5	6.5	

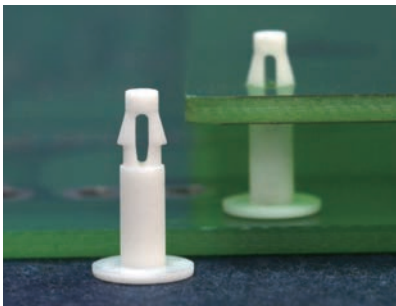

MOUNTING HOLE Ø2.0
THICKNESS 1.6

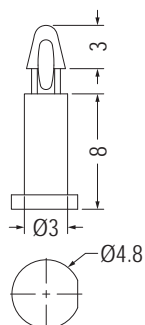

Part No.	Package
MAL-8	1000

MOUNTING HOLE Ø2.0
THICKNESS 2.4

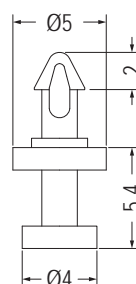

Part No.	Package
MASL-5.4	1000

MOUNTING HOLE Ø2.0
THICKNESS: T

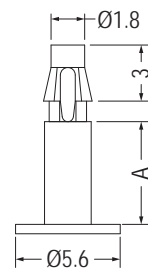

Part No.	A	T	Package
MAST-6	5.5	1.0	1000
MAST-18	18.3	1.6	

PCB間隔柱 PCB SPACER

用途：支撐PC板，使中間不致震動，載重而凹陷短路。

- Material: Nylon 66 (UL)
- Flame Class: 94V-2/94V-0
- Color: Natural/Black
- Unit: mm

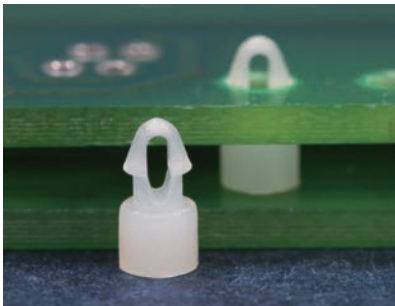
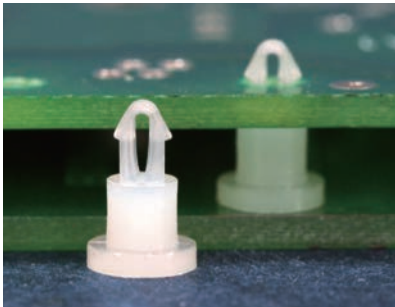
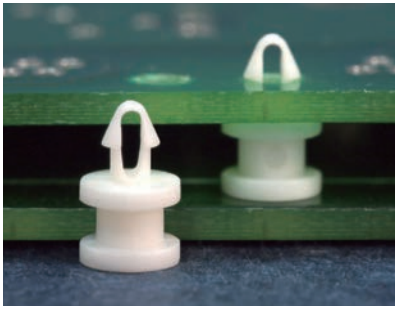

MOUNTING HOLE Ø2.0
THICKNESS 1.4

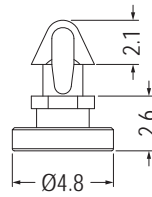

Part No.	Package
MABA-2.6	2000

MOUNTING HOLE Ø2.0
THICKNESS 1.6

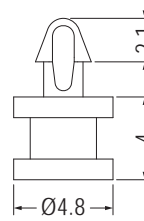

Part No.	Package
MAB-4	1000

MOUNTING HOLE Ø2.0
THICKNESS 1.0

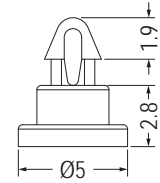

Part No.	Package
MA-2.8S	2000

MOUNTING HOLE Ø2.0
THICKNESS 1.6

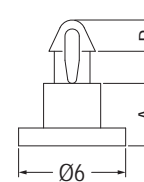

Part No.	A	B	Package
MA-2.7DL	2.7	1.9	2000
MA-3.5DL	3.5	1.75	
MA-3.85DL	3.85	1.9	
MA-4.5DL	4.5	1.9	
MA-5DL	5.0	1.9	
MA-6.5DL	6.5	1.9	

MOUNTING HOLE Ø2.0
THICKNESS 1.0

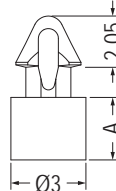

Part No.	A	Package
MA-2.5S	2.5	2000
MA-3S-1	3.0	

MOUNTING HOLE Ø2.5
THICKNESS 1.0

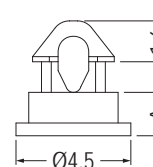

Part No.	A	Package
MAMS-1.5	1.5	2000
MAMS-1.7	1.7	
MAMS-5	5.0	

MOUNTING HOLE Ø2.0
THICKNESS: T

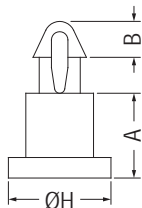

Part No.	A	B	H	T	Package
MA-1.8	1.8	1.9	4.2	1.6	2000
MA-2	2.0	1.9	4.2	1.6	
MA-2L	2.0	2.05	4.8	2.0	
MA-2.5	2.5	1.9	4.1	1.6	
MA-2.5L	2.5	2.0	4.8	1.6	
MA-3	3.0	1.9	4.8	1.6	
MA-3S	3.0	1.8	4.2	1.6	
MA-3.2	3.2	1.9	4.8	1.6	
MA-3.2-1	3.2	2.1	4.8	1.6	
MA-3.5	3.5	1.9	4.2	1.6	
MA-3.5L	3.5	2.0	4.8	1.6	
MA-3.75	3.75	2.0	4.8	1.6	
MA-4	4.0	1.9	4.8	1.6	
MA-4.5	4.5	1.9	4.2	1.6	
MA-4.7	4.7	1.9	4.8	1.6	
MA-5	5.0	1.9	4.8	1.6	
MA-5.6	5.6	2.0	4.2	1.6	
MA-6	6.0	1.9	5.0	1.6	
MA-6.5	6.5	1.9	5.0	1.6	
MA-6.75	6.75	1.9	5.0	1.6	
MA-8	8.0	1.9	5.0	1.6	
MA-9	9.0	1.9	5.0	1.6	

MOUNTING HOLE Ø2.5
THICKNESS 1.0

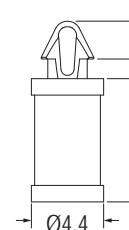

Part No.	Package
MAMS-7.5	1000

PCB間隔柱 PCB SPACER

用途：支撐PC板，使中間不致震動，載重而凹陷短路。

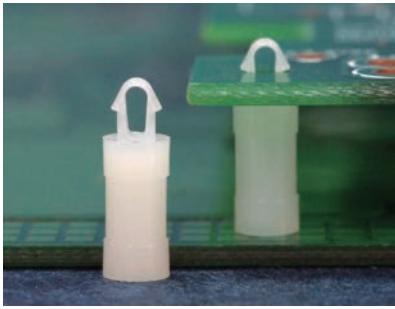

- Material: Nylon 66 (UL)
- Flame Class: 94V-2/94V-0
- Color: Natural/Black
- Unit: mm

MOUNTING HOLE Ø2.6
THICKNESS 1.6

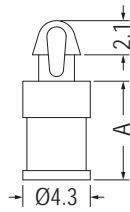

【 MAM-6.35L 】

MOUNTING HOLE Ø2.5
THICKNESS 1.6

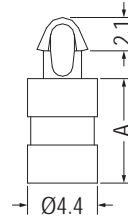

Part No.	A	Package
MAM-6.35L	6.35	2000
MAM-6.8	6.8	
MAM-7	7.0	
MAM-8	8.0	
MAM-8.4	8.4	
MAM-9	9.0	
MAM-9.5	9.5	
MAM-11	11.1	
MAM-12.7	12.7	
MAM-15.9	15.9	



MOUNTING HOLE Ø2.5
THICKNESS 1.6~1.8

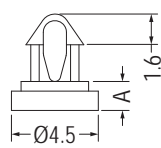

【 MAM-1.5L 】

MOUNTING HOLE Ø2.5
THICKNESS 1.4~1.6

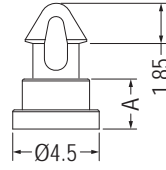

【 MAM-2.6 】

Part No.	A	Package
MAM-1.5	1.5	2000
MAM-1.5L	1.5	
MAM-2	2.0	
MAM-2.5	2.5	
MAM-2.6	2.6	
MAM-2.7	2.7	
MAM-3	3.0	
MAM-3.2	3.2	
MAM-3.5	3.5	
MAM-4	4.0	
MAM-4.5	4.5	
MAM-4.8	4.8	
MAM-5	5.0	
MAM-5.7	5.7	
MAM-6	6.0	
MAM-6.4	6.4	

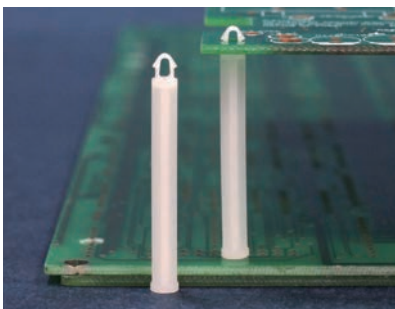

MOUNTING HOLE Ø2.5
THICKNESS 1.6

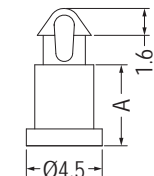

【 MAM-4.8, MAM-6.4 】

MOUNTING HOLE Ø2.5
THICKNESS 1.6~1.8

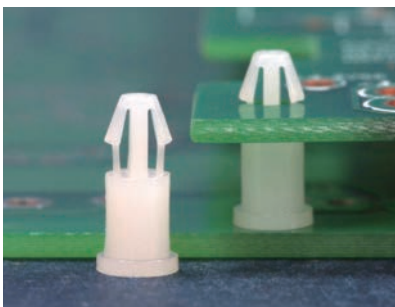
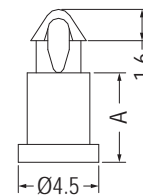

MOUNTING HOLE Ø3.0
THICKNESS: T

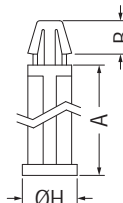

【 DCC-20S 】

MOUNTING HOLE Ø3.0
THICKNESS: T

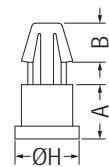

Part No.	A	B	H	T	Package
DCC-2	2.0	3.1	5.0	1.2~1.6	2000
DCC-2.5	2.5	3.1	5.0	1.2~1.6	
DCC-2.7	2.7	3.1	5.0	1.2~1.6	
DCC-3	3.0	3.1	5.0	1.2~1.6	
DCC-3.2	3.2	3.1	5.0	1.2~1.6	
DCC-3.5	3.5	3.1	5.0	1.2~1.6	
DCC-4	4.0	3.1	5.0	1.2~1.6	1000
DCC-4.5	4.5	3.1	5.0	1.2~1.6	
DCC-5	5.0	3.1	5.0	1.2~1.6	
DCC-5S	5.0	2.6	5.0	0.8~1.2	
DCC-5.5	5.5	3.1	5.0	1.2~1.6	
DCC-6	6.0	3.1	5.0	1.2~1.6	
DCC-6.2	6.2	3.1	5.0	1.2~1.6	
DCC-6.5	6.5	3.1	5.0	1.2~1.6	
DCC-9.5L	9.5	3.1	6.0	1.2~1.6	
DCC-20S	20.0	3.1	5.0	0.8	

MOUNTING HOLE Ø2.7
THICKNESS 1.6

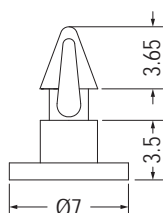

Part No.	Package
MAMA-3.5	1000

MOUNTING HOLE Ø3.0
THICKNESS 1.6

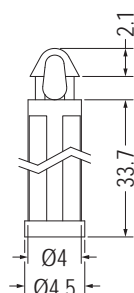

Part No.	Package
MAL-34	1000

PCB間隔柱 PCB SPACER

用途：支撐PC板，使中間不致震動，載重而凹陷短路。

- Material: Nylon 66 (UL)
- Flame Class: 94V-2/94V-0
- Color: Natural/Black
- Unit: mm

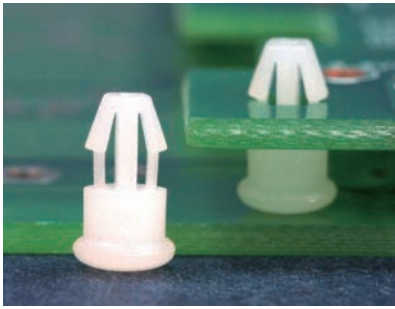

MOUNTING HOLE $\varnothing 3.0$
THICKNESS 1.6

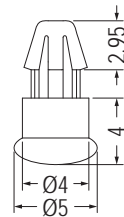

Part No.	Package
DCE-4	1000

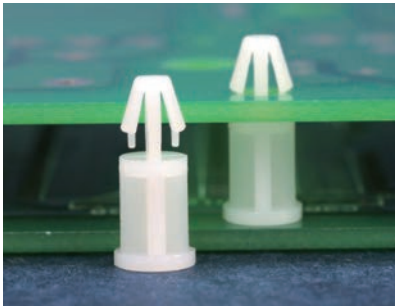

MOUNTING HOLE $\varnothing 3.5$
THICKNESS 0.8-1.6

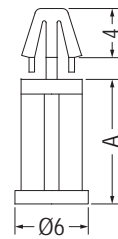

Part No.	A	Package
MCM-8	8.0	1000
MCM-14.5	14.5	

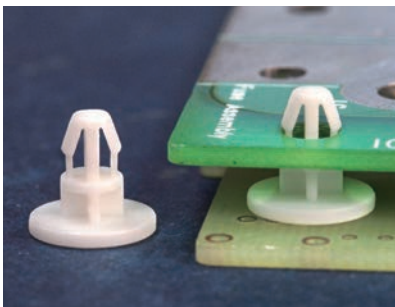

MOUNTING HOLE $\varnothing 3.7$
THICKNESS 1.6

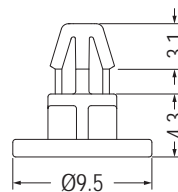

Part No.	Package
DCCA-4.3	1000

MOUNTING HOLE $\varnothing 4.0$
THICKNESS 1.2-1.6

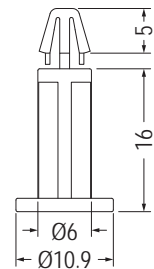

Part No.	Package
MCO-16	1000

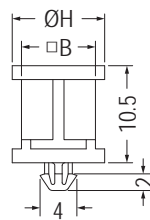
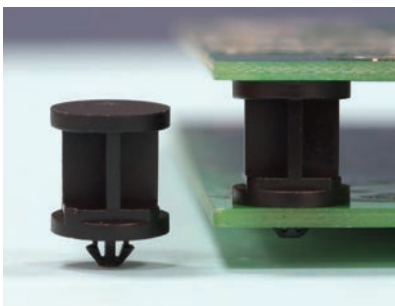

MOUNTING HOLE $\varnothing 3.0$
THICKNESS: T

Part No.	B	H	T	Package
TCBA-10.5S	6.0	7.5	1.0	1000
TCBA-10.5	8.0	10.0	1.0	
TCBA-10.5L	8.0	10.0	1.6	

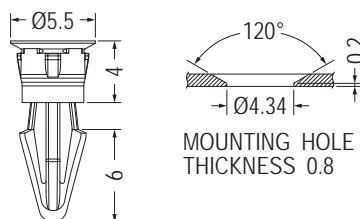

MOUNTING HOLE
THICKNESS 0.8

MOUNTING HOLE $\varnothing 3.0$ - $\varnothing 3.18$
THICKNESS 1.6

Part No.	Package
DCCB-4.1	1000

PCB間隔柱 PCB SPACER

用途：支撐PC板，使中間不致震動，載重而凹陷短路。

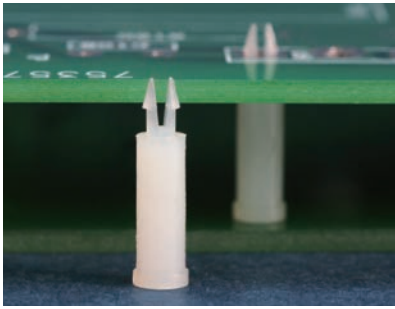

- Material: Nylon 66 (UL)
- Flame Class: 94V-2/94V-0
- Color: Natural/Black
- Unit: mm

MOUNTING HOLE $\varnothing 2.0$
THICKNESS 1.2-1.8

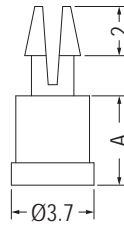

Part No.	A	Package
MS-4	4.0	2000
MS-5	5.0	
MS-10	10.0	

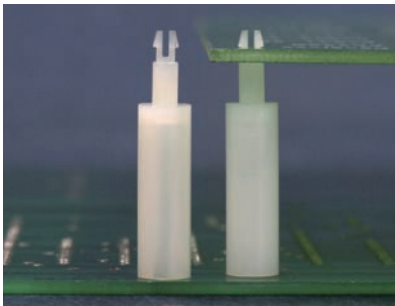

MOUNTING HOLE $\varnothing 2.2$
THICKNESS 1.6

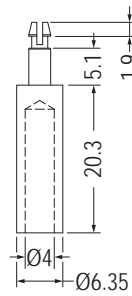

Part No.	Package
PCLS-25	1000

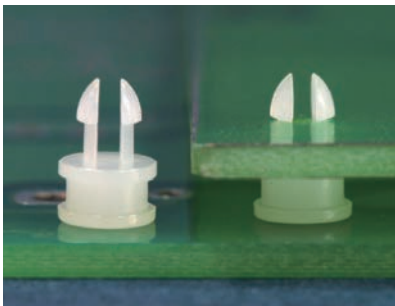

MOUNTING HOLE $\varnothing 2.3$
THICKNESS 1.6

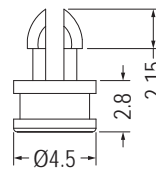

Part No.	Package
MSB-2.8	1000

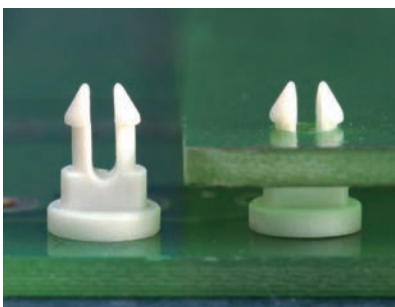

- Material: PBT (UL)
- Flame Class: 94V-0
- Color: Natural
- Unit: mm

MOUNTING HOLE $\varnothing 2.5$
THICKNESS 1.6

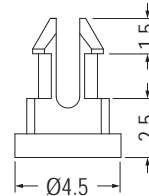

Part No.	Package
MSM-2.5	1000

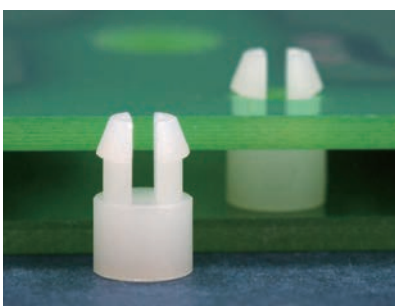

- Material: Nylon 66 (UL)
- Flame Class: 94V-2/94V-0
- Color: Natural/Black
- Unit: mm

MOUNTING HOLE $\varnothing 3.9$
THICKNESS 1.6

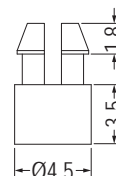

Part No.	Package
MSMA-3.5	2000

PCB間隔柱 PCB SPACER

1



- Material: Nylon 66 (UL)
- Flame Class: 94V-2/94V-0
- Color: Natural/Black
- Unit: mm

MOUNTING HOLE Ø2.5
THICKNESS 1.6

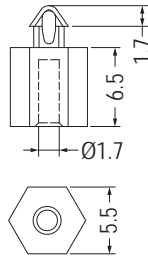

Part No.	Package
MAE2.5-6.5	2000

MOUNTING HOLE Ø2.5
THICKNESS 1.6

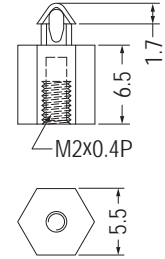

• MAE2.5-6.5T為已攻牙M2x0.4P

Part No.	Package
MAE2.5-6.5T	2000

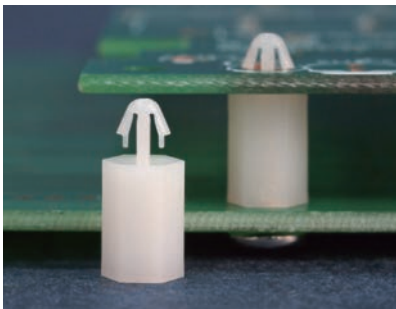

- Material: Nylon 66 (UL)
- Flame Class: 94V-2/94V-0
- Color: Natural/Black
- Unit: mm

用途：PC板端直接壓入固定，另一端可配合M3螺絲或自攻螺絲固定。

MOUNTING HOLE Ø3.0
THICKNESS 1.6

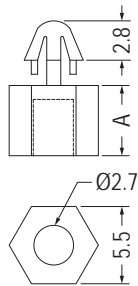

Part No.	A	Package
MAE-4	4.0	1000
MAE-5	5.0	2000
MAE-6	6.0	
MAE-7	7.0	
MAE-8	8.0	
MAE-9	9.0	
MAE-10	10.0	1000
MAE-11	11.0	
MAE-12	12.0	
MAE-13	13.0	

Part No.	A	Package
MAE-14	14.0	1000
MAE-15	15.0	
MAE-16	16.0	
MAE-17	17.0	
MAE-18	18.0	
MAE-19	19.0	
MAE-20	20.0	
MAE-22	22.0	
MAE-23.5	23.5	
MAE-26	26.0	

MOUNTING HOLE Ø3.0
THICKNESS 1.6

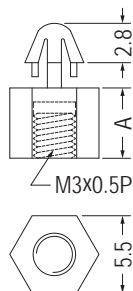

• MAE-XT為已攻牙M3x0.5P

Part No.	A	Package
MAE-5T	5.0	2000
MAE-6T	6.0	
MAE-7T	7.0	
MAE-8T	8.0	
MAE-9T	9.0	
MAE-10T	10.0	1000
MAE-11T	11.0	
MAE-12T	12.0	
MAE-13T	13.0	
MAE-14T	14.0	
MAE-15T	15.0	

Part No.	A	Package
MAE-16T	16.0	1000
MAE-17T	17.0	
MAE-18T	18.0	
MAE-19T	19.0	
MAE-20T	20.0	
MAE-22T	22.0	
MAE-23.5T	23.5	
MAE-26T	26.0	
MAE-26.5T	26.5	
MAE-27T	27.0	

PCB間隔柱 PCB SPACER

用途：PC板端直接壓入固定，另一端可配合M3螺絲或自攻螺絲固定。

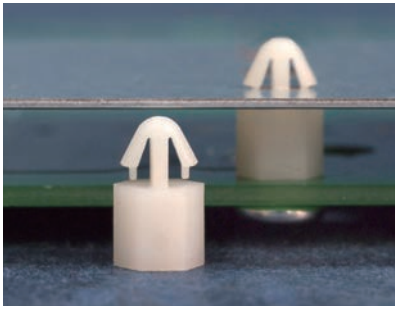

- Material: Nylon 66 (UL)
- Flame Class: 94V-2/94V-0
- Color: Natural/Black
- Unit: mm

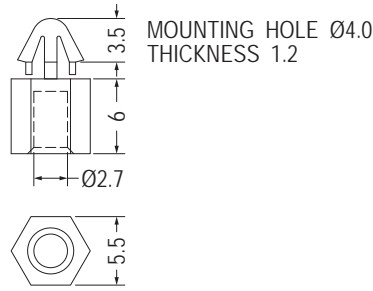

Part No.	Package
MAE4D-6	1000

MOUNTING HOLE Ø4.0
THICKNESS 1.2

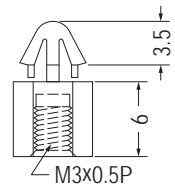

• MAE4D-6T為已攻牙M3x0.5P

Part No.	Package
MAE4D-6T	1000

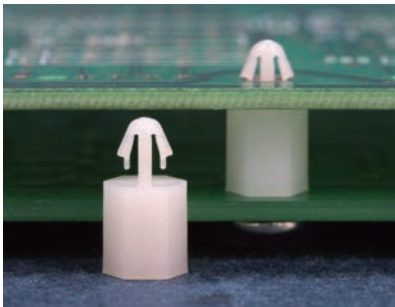

- Material: Nylon 66 (UL)
- Flame Class: 94V-2/94V-0
- Color: Natural/Black
- Unit: mm

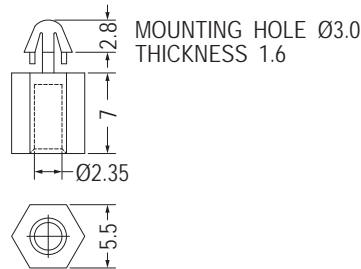

Part No.	Package
MAE7-440	2000

用途：PC板端直接壓入固定，另一端可配合螺絲或自攻螺絲固定。

MOUNTING HOLE Ø3.0
THICKNESS 1.6

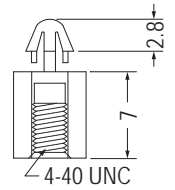

• MAE7-440T為已攻牙4-40UNC

Part No.	Package
MAE7-440T	2000

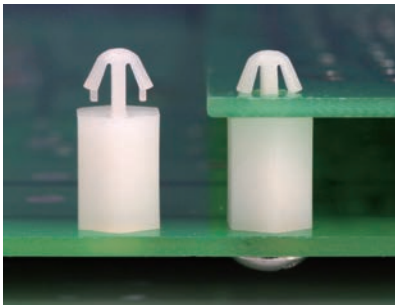

- Material: Nylon 66 (UL)
- Flame Class: 94V-2/94V-0
- Color: Natural/Black
- Unit: mm

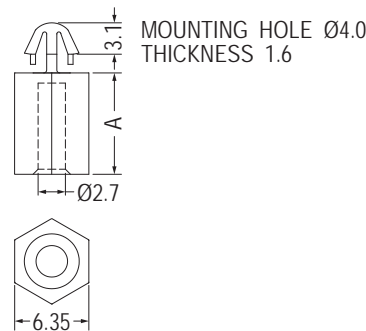

Part No.	A	Package
MAE43-5	5.0	2000
MAE43-6	6.0	
MAE43-7	7.0	
MAE43-8	8.0	
MAE43-9	9.0	
MAE43-10	10.0	
MAE43-11	11.0	
MAE43-12.7	12.7	
MAE43-14	14.0	
MAE43-15	15.0	
MAE43-15.9	15.9	
MAE43-20	20.0	

用途：PC板端直接壓入固定，另一端可配合M3螺絲或自攻螺絲固定。

MOUNTING HOLE Ø4.0
THICKNESS 1.6

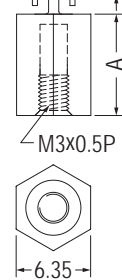

• MAE43-XT為已攻牙M3x0.5P

Part No.	A	Package
MAE43-5T	5.0	2000
MAE43-6T	6.0	
MAE43-7T	7.0	
MAE43-8T	8.0	
MAE43-9T	9.0	
MAE43-10T	10.0	
MAE43-11T	11.0	
MAE43-12.7T	12.7	
MAE43-14T	14.0	
MAE43-15T	15.0	
MAE43-15.9T	15.9	
MAE43-20T	20.0	

MOUNTING HOLE Ø4.0
THICKNESS 1.85

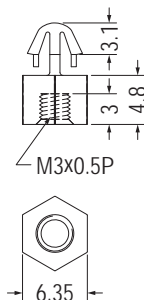

Part No.	Package
MAE43-4.8LT	1000

PCB間隔柱 PCB SPACER

用途：PC板端直接壓入固定，另一端可配合M4螺絲或自攻螺絲固定。

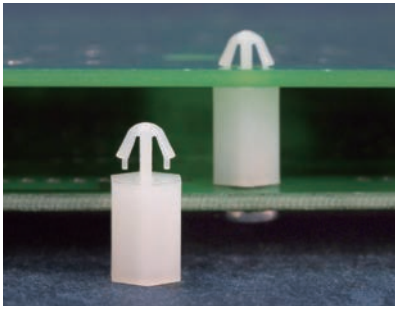

- Material: Nylon 66 (UL)
- Flame Class: 94V-2/94V-0
- Color: Natural/Black
- Unit: mm

MOUNTING HOLE Ø4.0
THICKNESS 1.6

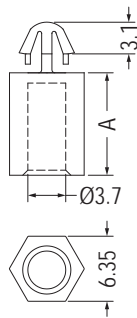

MOUNTING HOLE Ø4.0
THICKNESS 1.6

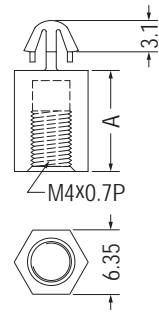

• MAE4-XT為已攻牙M4x0.7P

Part No.	A	Package
MAE4-5	5.0	2000
MAE4-6	6.0	
MAE4-7	7.0	
MAE4-8	8.0	
MAE4-9	9.0	
MAE4-10	10.0	
MAE4-11	11.0	
MAE4-12.7	12.7	
MAE4-14	14.0	
MAE4-15	15.0	
MAE4-15.9	15.9	
MAE4-20	20.0	

Part No.	A	Package
MAE4-5T	5.0	2000
MAE4-6T	6.0	
MAE4-7T	7.0	
MAE4-8T	8.0	
MAE4-9T	9.0	
MAE4-10T	10.0	
MAE4-11T	11.0	
MAE4-12.7T	12.7	
MAE4-14T	14.0	
MAE4-15T	15.0	
MAE4-15.9T	15.9	
MAE4-20T	20.0	

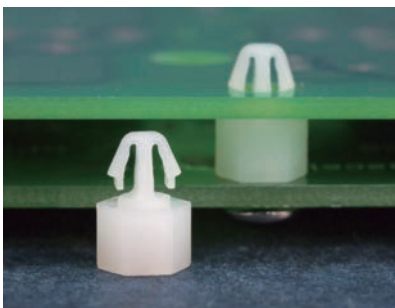

- Material: Nylon 66 (UL)
- Flame Class: 94V-2/94V-0
- Color: Natural/Black
- Unit: mm

用途：機板部分用鐵板自攻螺絲固定，另一頭直接壓入PC板。

MOUNTING HOLE Ø4.0
THICKNESS 1.6

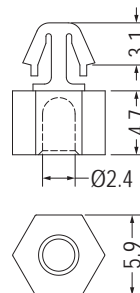

Part No.	Package
MCI-4.7	1000

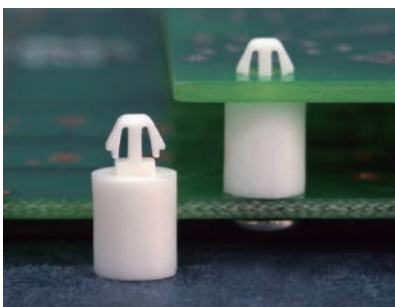

- Material: Nylon 66 (UL)
- Flame Class: 94V-2/94V-0
- Color: Natural/Black
- Unit: mm

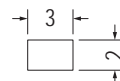
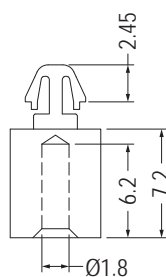

MOUNTING HOLE
THICKNESS 1.6

Part No.	Package
MCSH-7.2	1000

PCB間隔柱 PCB SPACER

用途：支撐PC板，使中間不致震動，載重而凹陷短路。

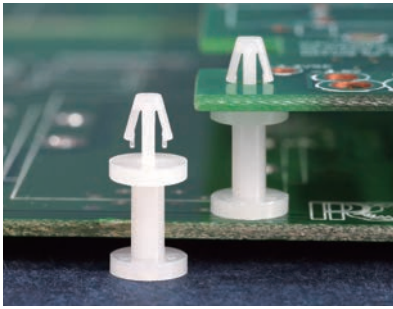

- Material: Nylon 66 (UL)
- Flame Class: 94V-2/94V-0
- Color: Natural/Black
- Unit: mm

MOUNTING HOLE Ø3.0
THICKNESS 1.6

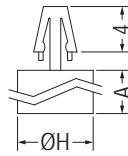

MOUNTING HOLE Ø3.0
THICKNESS: T

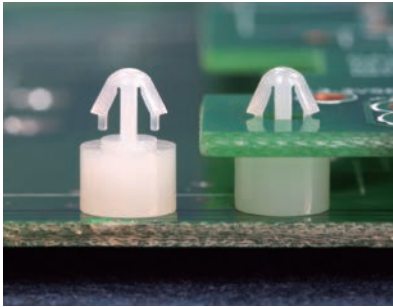
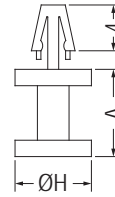

Part No.	A	H	Package
DCB-2	2.0	6.5	2000
DCB-2.5	2.5	6.5	
DCB-3	3.0	6.8	
DCB-3.5	3.5	6.8	1000
DCB-4	4.0	6.8	

Part No.	A	H	T	Package
DCB-5	5.0	6.0	1.6	1000
DCB-5.8	5.8	6.9	1.6	
DCB-6	6.0	6.8	1.6	
DCB-6.5	6.5	6.0	1.6	
DCB-7	7.0	6.0	1.6	
DCB-8	8.0	6.8	1.6	
DCB-8(2)	8.0	6.8	2.1	
DCB-10	10.0	6.8	1.6	
DCB-15	15.0	6.0	1.6	
DCB-15L	15.0	15.0	1.6	
DCB-15S	15.0	6.0	1.6	

MOUNTING HOLE Ø3.0
THICKNESS: T

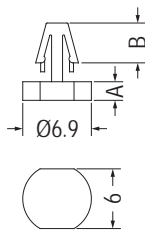

【 DCB-2D,
DCB-3D,
DCB-3.5D 】

MOUNTING HOLE Ø3.0
THICKNESS: T

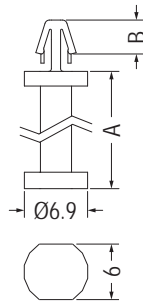

【 DCB-15D 】

MOUNTING HOLE Ø3.0
THICKNESS: T

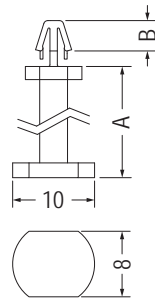

【 DCB-16DL,
DCB-20DL 】

MOUNTING HOLE Ø3.0
THICKNESS: T

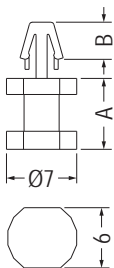

Part No.	A	B	T	Package
DCB-2D	2.0	3.5	1.2~1.7	2000
DCB-3D	3.0	3.7	1.2~1.6	
DCB-3.5D	3.5	4.0	1.2~1.6	
DCB-4D	4.0	3.6	1.2~1.7	1000
DCB-4.5D	4.5	3.6	1.2~1.7	
DCB-5D	5.0	3.6	1.2~1.7	
DCB-5.5D	5.5	4.0	1.2~1.6	
DCB-7D	7.0	4.0	1.2~1.6	

Part No.	A	B	T	Package
DCB-8D	8.0	3.85	1.2~1.7	1000
DCB-8.5D	8.5	4.0	1.2~1.7	
DCB-9D	9.0	4.0	1.2~1.6	
DCB-11D	11.0	3.7	1.2~1.6	
DCB-12D	12.0	4.0	1.2~1.6	
DCB-13D	13.0	4.0	1.2~1.6	
DCB-15D	15.0	3.7	1.2~1.6	
DCB-16DL	16.0	3.7	1.2~1.6	
DCB-20DL	20.0	3.7	1.2~1.6	

MOUNTING HOLE Ø3.0
THICKNESS 3.0

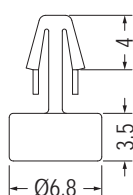

Part No.	Package
DCBA-3.5	1000

MOUNTING HOLE Ø3.1
THICKNESS 1.6

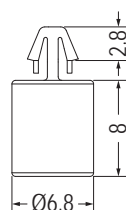

Part No.	Package
DCBA-8	1000

MOUNTING HOLE Ø3.5
THICKNESS 1.6

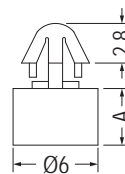

Part No.	A	Package
PDC-3	3.0	2000
PDC-3.5	3.5	
PDC-4	4.0	

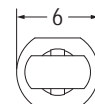

MOUNTING HOLE Ø3.5
THICKNESS 1.6

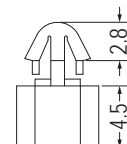

Part No.	Package
PDC-4.5D	2000

PCB間隔柱 PCB SPACER

用途：支撐PC板，使中間不致震動，載重而凹陷短路。

- Material: Nylon 66 (UL)
- Flame Class: 94V-2/94V-0
- Color: Natural/Black
- Unit: mm

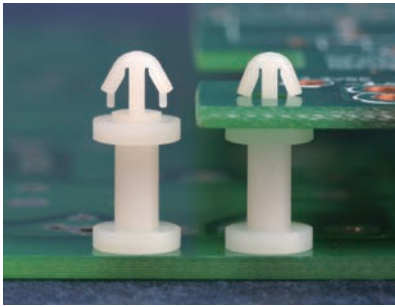

MOUNTING HOLE Ø3.5
THICKNESS: T

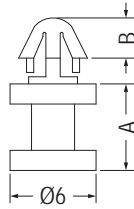

Part No.	A	B	T	Package
PDC-5	5.0	2.8	1.6	2000
PDC-9	9.0	2.8	1.6	
PDC-10	10.0	2.6	1.8	

MOUNTING HOLE Ø3.5
THICKNESS: T

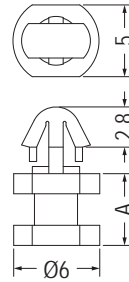

Part No.	A	T	Package
PDC-5.5D	5.5	1.6	2000
PDC-6D	6.0	1.6	
PDC-6.5D	6.5	1.6	
PDC-7D	7.0	1.6	
PDC-13D	13.0	1.2~1.7	
PDC-13.5D	13.5	1.6	
PDC-26D	26.0	1.6	



MOUNTING HOLE Ø3.5
THICKNESS 1.6

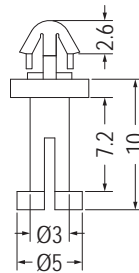

Part No.	Package
MCN-10	1000

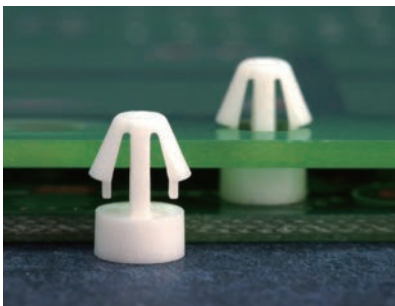

MOUNTING HOLE Ø4.0
THICKNESS: T

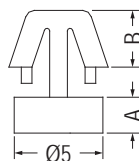

Part No.	A	B	T	Package
MC-2	2.0	3.1	1.2~1.7	2000
MC-2-1.2	2.0	3.5	0.8~1.0	
MC-2.5	2.5	3.65	1.2~1.7	1000

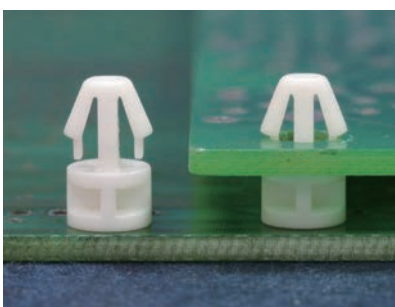

MOUNTING HOLE Ø4.0
THICKNESS 1.2~1.6

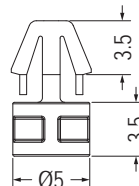

Part No.	Package
MC-3.5-1	1000

MOUNTING HOLE Ø4.0
THICKNESS 1.6

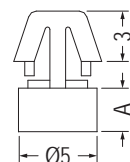

Part No.	A	Package
MC-3	3.0	2000
MC-3.2	3.2	
MC-3.5	3.5	
MC-4	4.0	
MC-5	5.0	

PCB間隔柱 PCB SPACER

用途：支撐PC板，使中間不致震動，載重而凹陷短路。

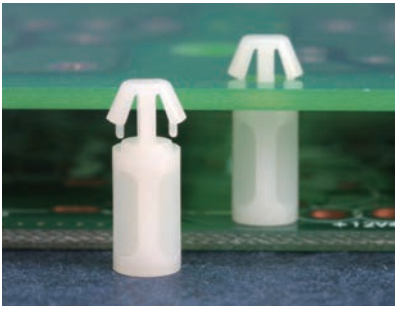

- Material: Nylon 66 (UL)
- Flame Class: 94V-2/94V-0
- Color: Natural/Black
- Unit: mm

MOUNTING HOLE $\varnothing 4.0$
THICKNESS 1.6

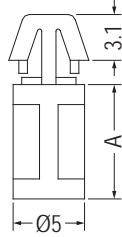

Part No.	A	Package
MC-6	6.3	2000
MC-7	7.0	
MC-7.5	7.5	
MC-8	8.0	
MC-8.5	8.5	
MC-9	9.0	
MC-10	10.0	1000
MC-11.5	11.5	
MC-12	12.7	
MC-16.4	16.4	

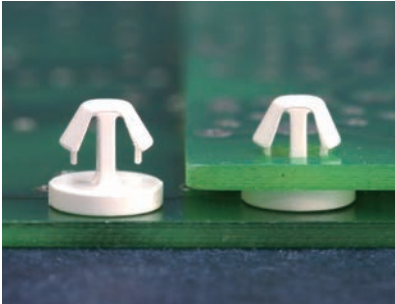

MOUNTING HOLE $\varnothing 4.0$
THICKNESS 1.6-1.9

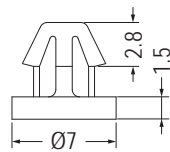

Part No.	Package
MCEA-1.9	1000

MOUNTING HOLE $\varnothing 4.0$
THICKNESS 1.6-1.8

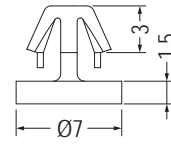

- Material: PC (UL)

Part No.	Package
MCE-1.9	1000

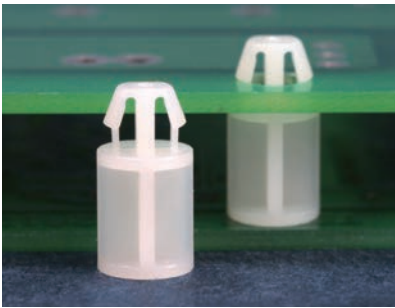

MOUNTING HOLE $\varnothing 4.8$
THICKNESS 1.6

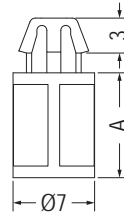

Part No.	A	Package
MCL-9	9.0	2000
MCL-16	16.0	

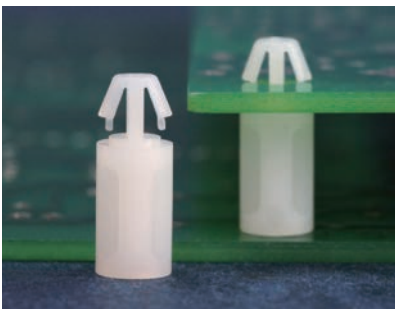

- Material: Nylon 66 (UL)
- Flame Class: 94V-2/94V-0
- Color: Natural/Black
- Unit: mm

用途：支撐PC板，使中間不致震動，載重而凹陷短路，鐵板可鑽孔用螺絲固定。

MOUNTING HOLE $\varnothing 4.0$
THICKNESS 1.6

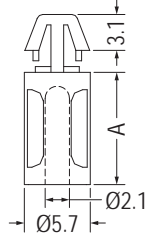

Part No.	A	Package
MCH-6	6.35	1000
MCH-10	9.7	
MCH-12	12.7	

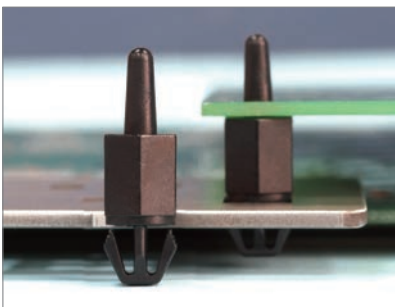

- Material: Nylon 66 (UL)
- Flame Class: 94V-2/94V-0
- Color: Natural/Black
- Unit: mm

用途：PC板直接壓入固定，另一端直接壓入機板固定，省時易拆裝。

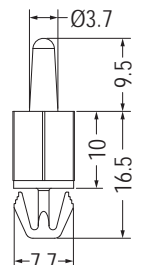

MOUNTING HOLE
THICKNESS 0.8-1.6

Part No.	Package
KVLMA-10	1000

PCB間隔柱 PCB SPACER

1

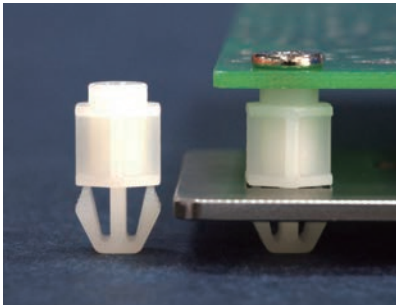

- Material: Nylon 66 (UL)
- Flame Class: 94V-2/94V-0
- Color: Natural/Black
- Unit: mm

用途：固定PC板於機板上，一頭配合螺絲使用，不旋轉。

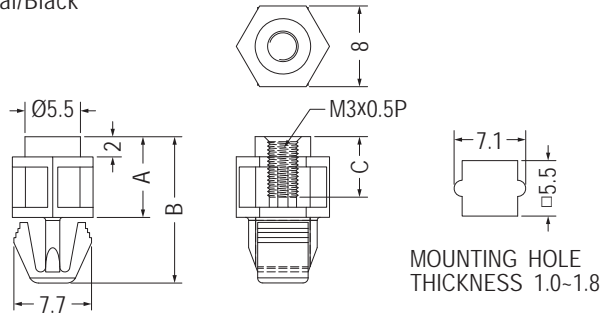

Part No.	A	B	C	Package
KVLM3-5	5.0	11.5	3.0	1000
KVLM3-6	6.0	12.5	4.0	
KVLM3-6.35	6.35	12.85	4.35	
KVLM3-8	8.0	14.5	6.0	
KVLM3-9.5	9.5	16.0	8.0	
KVLM3-10	10.0	16.5	8.0	
KVLM3-12	12.0	18.5	8.0	

Part No.	A	B	C	Package
KVLM3-12.7	12.7	19.2	8.0	1000
KVLM3-15.9	15.9	22.4	8.0	
KVLM3-18	18.0	24.5	8.0	
KVLM3-20	20.0	26.5	8.0	
KVLM3-22	22.0	28.5	8.0	
KVLM3-25.4	25.4	31.9	8.0	

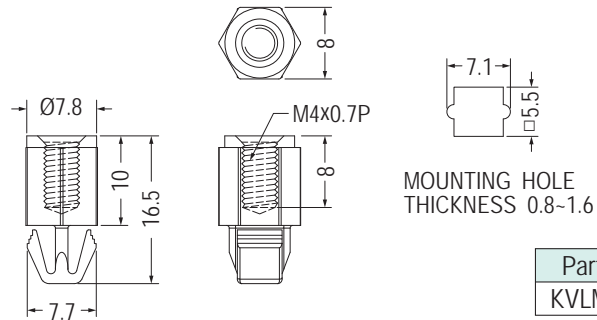
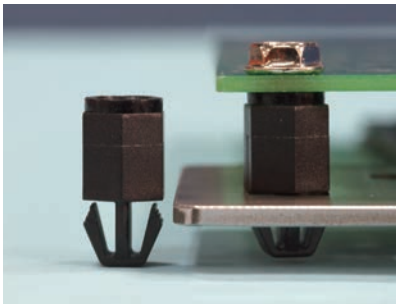

Part No.	Package
KVLM4-10	1000

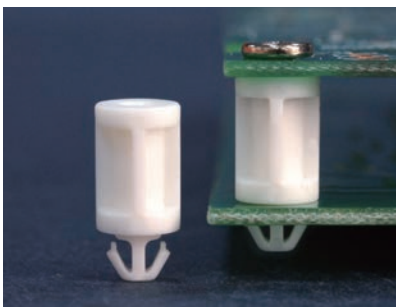

- Material: Nylon 66 (UL)
- Flame Class: 94V-2/94V-0
- Color: Natural/Black
- Unit: mm

用途：固定PC板於機板上，一頭配合螺絲使用。

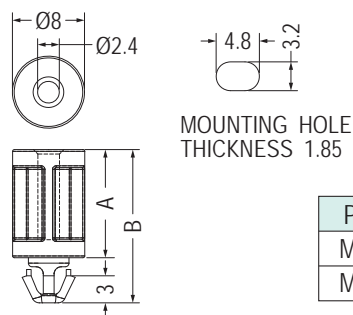

Part No.	A	B	Package
MCIA-12	12.0	17.0	1000
MCIA-16	16.0	21.0	

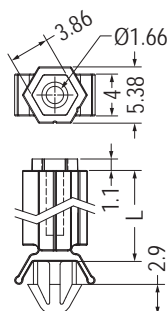
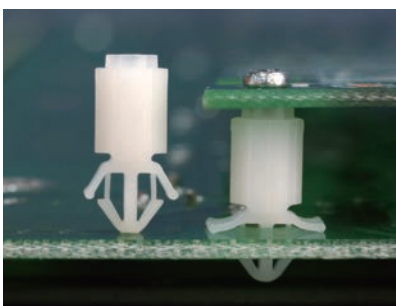

Part No.	L	Package
TCBC-8.7	8.7	1000
TCBC-13.7	13.7	

MOUNTING HOLE Ø4.0 THICKNESS 0.8-1.6

PCB間隔柱 PCB SPACER

用途：固定PC板於機板上，一頭配合自攻螺絲使用。

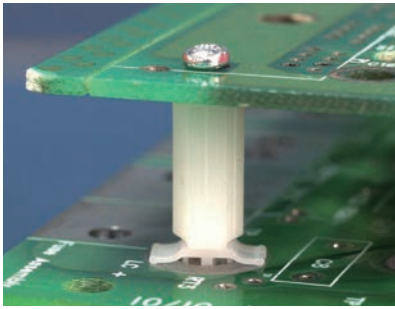

- Material: Nylon 66 (UL)
- Flame Class: 94V-2/94V-0
- Color: Natural/Black
- Unit: mm

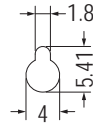
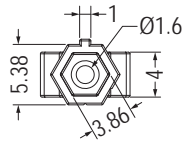

MOUNTING HOLE THICKNESS 0.8

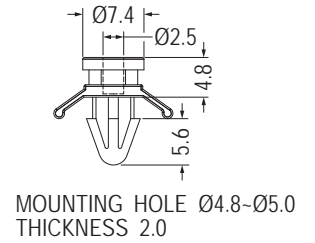

MOUNTING HOLE Ø4.8-Ø5.0 THICKNESS 2.0

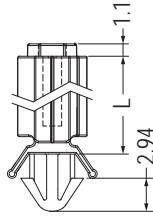

Part No.	L	Package
TCBE-8.7	8.7	1000
TCBE-13.7	13.7	

Part No.	Package
TCBD-4.8	1000

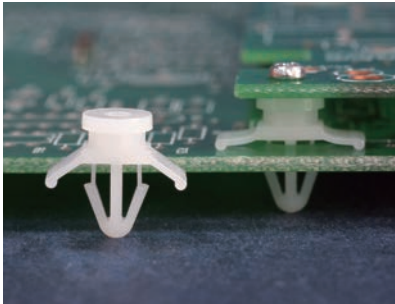

- Material: Nylon 66 (UL)
- Flame Class: 94V-2/94V-0
- Foot Material: Silicon Rubber (UL)
- Foot Flame Class: 94V-0
- Color: Natural/Black
- Unit: mm

用途：固定PC板於機板上，一頭有矽膠墊片支撐PC板，避免震動。

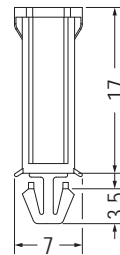
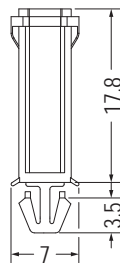

(PCB SPACER)
【TCBH-17】

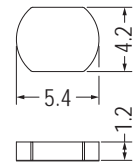

3M DOUBLE ADHESIVE TAPE

(FOOT)
【TF-1752I】

MOUNTING HOLE Ø4.0 THICKNESS 1.6

Part No.	Part No.	Package
TCBH-17F	TCBH-17	1000
	TF-1752I	
上述零件可單獨選購		

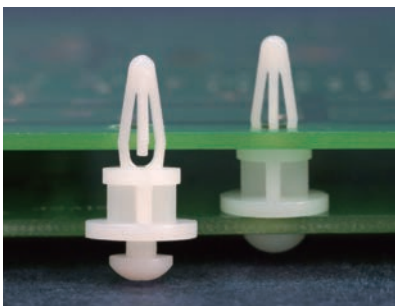

- Material: Nylon 66 (UL)
- Flame Class: 94V-2/94V-0
- Color: Natural/Black
- Unit: mm

用途：一般用於電腦機板固定。

MOUNTING HOLE Ø4.0 THICKNESS 1.6

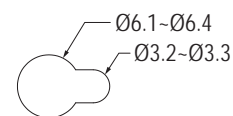
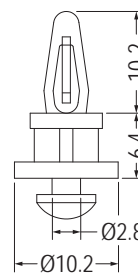

MOUNTING HOLE

THICKNESS 1.6

Part No.	Package
ACBR-6	1000

PCB間隔柱 PCB SPACER

用途：一般用於電腦機板固定。

1

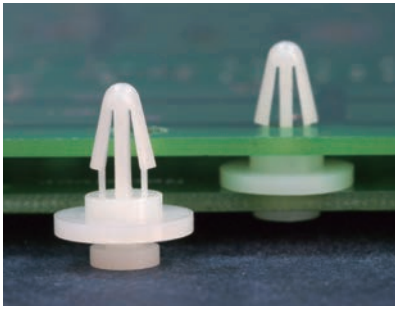

- Material: Nylon 66 (UL)
- Flame Class: 94V-2/94V-0
- Color: Natural/Black
- Unit: mm

MOUNTING HOLE Ø4.0
THICKNESS 2.7

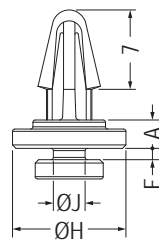

【ACB-2.3】

MOUNTING HOLE Ø4.0
THICKNESS 1.6-2.0

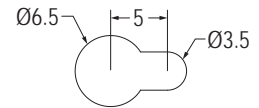
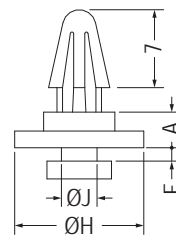

MOUNTING HOLE

Part No.	A	F	H	J	Package
ACB-2.3	2.5	1.0	10.0	2.8	1000
ACB-2.5	2.5	1.4	11.5	2.8	
ACB-3	3.2	1.2	11.6	3.2	

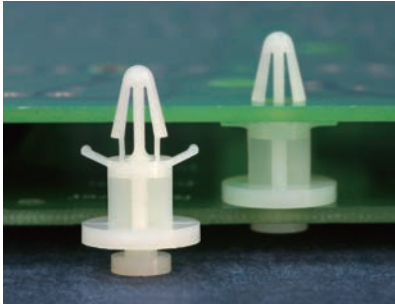

MOUNTING HOLE Ø4.0
THICKNESS: T

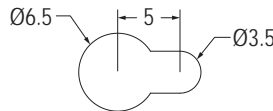
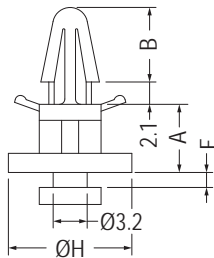

MOUNTING HOLE

MOUNTING HOLE Ø4.0
THICKNESS 1.6

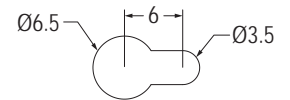
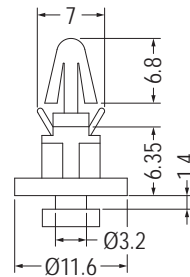

MOUNTING HOLE

Part No.	A	B	F	H	T	Package
ACB-5	5.0	7.0	1.3	11.7	1.6	1000
ACB-6	6.3	7.0	1.3	11.6	1.6	
ACB-8	8.0	7.0	1.4	11.6	1.6	
ACB-60	60.0	7.3	2.8	11.3	1.2~1.7	250
ACB-68	68.0	7.3	1.3	11.3	1.6	
ACB-74	74.0	7.3	1.3	11.3	1.6	

Part No.	Package
MCB-6	500

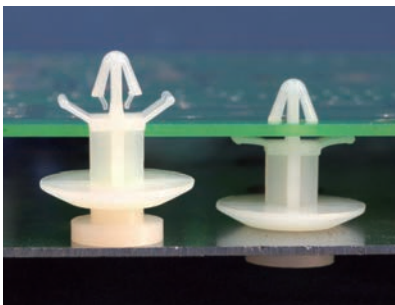

MOUNTING HOLE Ø4.5
THICKNESS 1.2-2.0

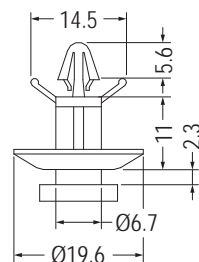

MOUNTING HOLE

Part No.	Package
MBC-11	500

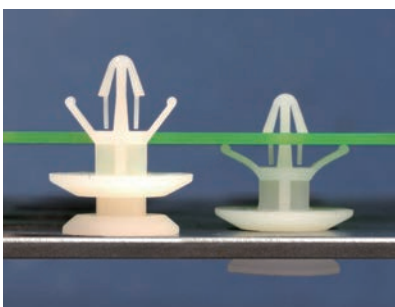

MOUNTING HOLE Ø4.5-Ø4.8
THICKNESS 0.8-2.5

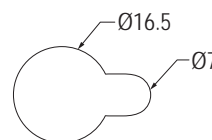
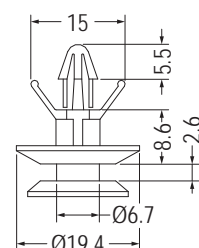

MOUNTING HOLE

Part No.	Package
MBD-10	500

PCB間隔柱 PCB SPACER

用途：機板部份用鐵板自攻螺絲固定，另一頭直接壓入PC板。

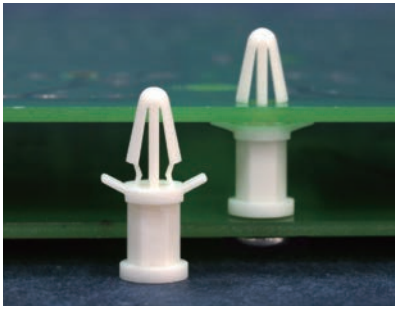

- Material: Nylon 66 (UL)
- Flame Class: 94V-2/94V-0
- Color: Natural/Black
- Unit: mm

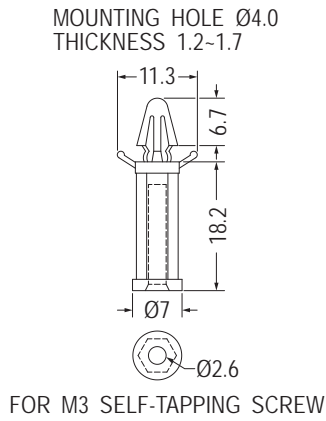

Part No.	Package
TCBS-18	1000

MOUNTING HOLE Ø4.0
THICKNESS 1.2-1.9

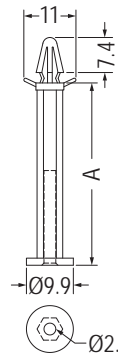

【 TCBS-38.5 】

FOR M3 SELF-TAPPING SCREW

MOUNTING HOLE Ø4.0
THICKNESS 1.2-1.7

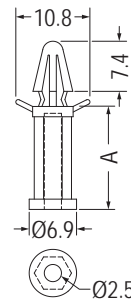

Part No.	A	Package
TCBS-5	5.0	1000
TCBS-6A	6.0	
TCBS-6	6.35	
TCBS-7	7.0	
TCBS-9.5	9.5	
TCBS-10	10.0	
TCBS-12.5	12.5	
TCBS-15	15.0	
TCBS-20	20.0	
TCBS-24.5	24.5	
TCBS-25	25.0	
TCBS-26	26.0	
TCBS-30	30.0	
TCBS-35	35.0	
TCBS-38.5	38.5	

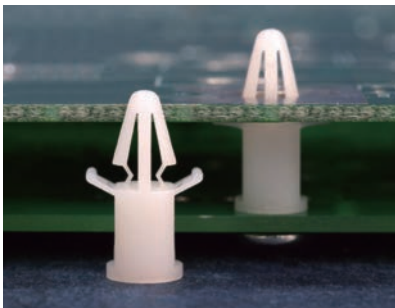

THICKNESS 1.2-1.7

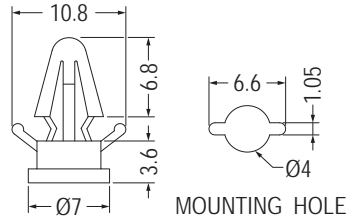

Part No.	Package
TCBT-3.6	1000

THICKNESS 1.2-1.7

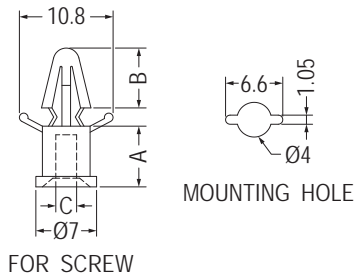

Part No.	A	B	C	Screw	Package
TCBT-7	7.0	6.9	2.4	4-40 UNC	1000
TCBT-7.7	7.7	5.9	2.6	M3	
TCBT-8.5	8.5	6.9	2.6	M3	
TCBT-16	16.0	6.9	2.4	4-40 UNC	

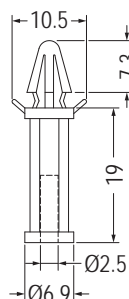
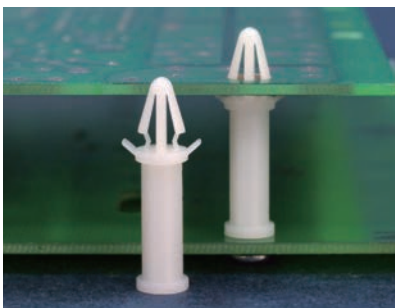

FOR M3 SCREW

THICKNESS 1.2-1.9

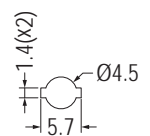

Part No.	Package
TCBT-19	1000

PCB間隔柱 PCB SPACER

1

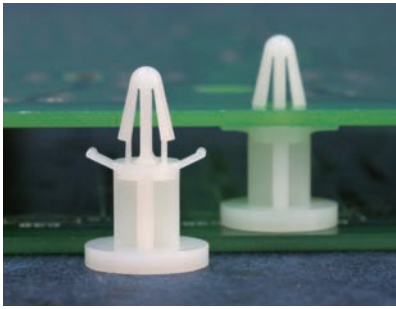

- Material: Nylon 66 (UL)
- Flame Class: 94V-2/94V-0
- Color: Natural/Black
- Unit: mm

MOUNTING HOLE $\varnothing 4.0$
THICKNESS 1.2-1.7

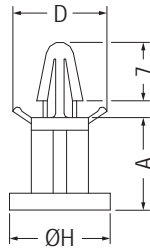

用途：支撐PC板，使中間不致震動，載重而凹陷短路。

Part No.	A	D	H	Package
MBS-6	6.4	11.4	11.8	1000
MBS-8	8.0	11.4	11.8	
MBS-8.9S	8.9	11.1	8.0	
MBS-8.9	8.9	11.1	11.9	
MBS-9.5L	9.5	11.4	20.0	
MBS-10	10.0	11.4	12.0	
MBS-11	11.0	11.4	12.0	500
MBS-14	14.0	11.4	12.0	250
MBS-74	74.0	10.4	11.3	

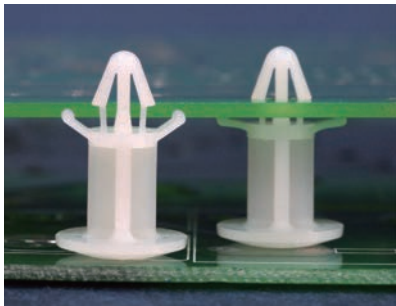

MOUNTING HOLE $\varnothing 4.5$
THICKNESS 1.2-1.7

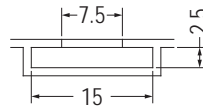
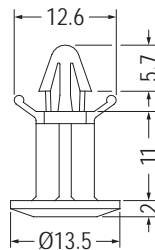

MOUNTING HOLE

Part No.	Package
MTD-11	500

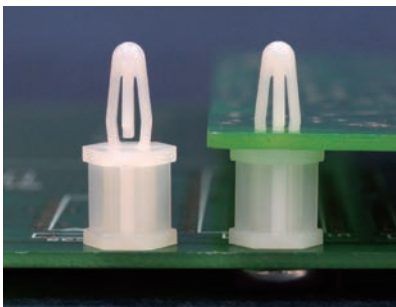

- Material: Nylon 66 (UL)
- Flame Class: 94V-2/94V-0
- Color: Natural/Black
- Unit: mm

用途：機板部份用M3.5鐵板自攻螺絲固定，另一頭直接壓入PC板。

MOUNTING HOLE $\varnothing 4.0$
THICKNESS 1.6

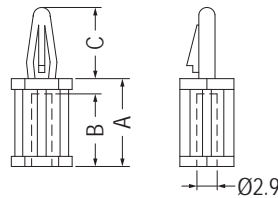

Part No.	A	B	C	Package
BS-6	6.4	4.8	10.2	1000
BS-9	9.5	8.0	10.2	
BS-12	12.7	11.0	10.2	
BS-14	14.0	12.7	10.2	
BS-15S	15.0	13.0	10.4	
BS-15	15.9	13.0	10.2	
BS-19	19.1	16.2	10.2	
BS-22	22.2	19.4	10.2	
BS-25	25.4	24.0	10.2	
BS-28	28.6	25.9	10.2	
BS-29	29.0	25.9	10.2	

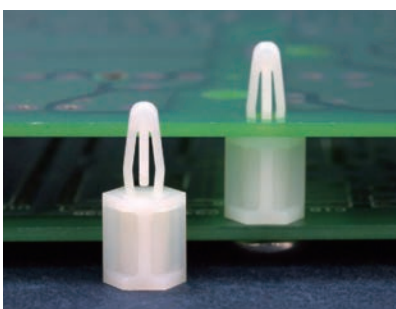

MOUNTING HOLE $\varnothing 4.0$
THICKNESS 2.0

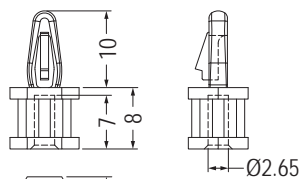

Part No.	Package
BS-8	1000

MOUNTING HOLE $\varnothing 4.0$
THICKNESS 1.6

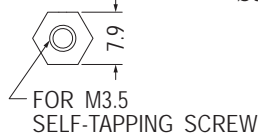
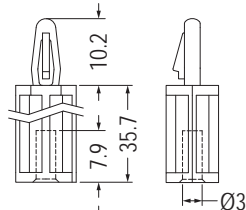

Part No.	Package
BS-35.7	500

MOUNTING HOLE $\varnothing 4.0$
THICKNESS 2.0

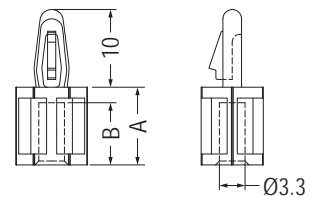

Part No.	A	B	Package
BS-10-1	10.0	8.0	1000
BS-20-1	20.0	12.0	1000

PCB間隔柱 PCB SPACER

用途：機板部份用M3鐵板自攻螺絲固定，另一頭直接壓入PC板。

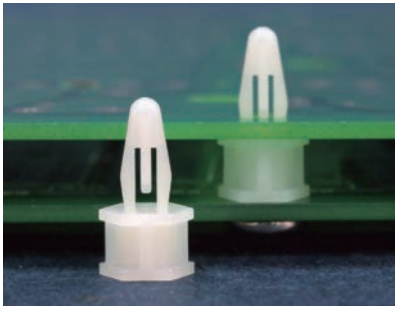

- Material: Nylon 66 (UL)
- Flame Class: 94V-2/94V-0
- Color: Natural/Black
- Unit: mm

MOUNTING HOLE Ø4.0
THICKNESS 1.2-1.7

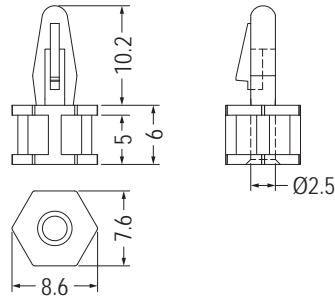

Part No.	Package
BSB-6	1000

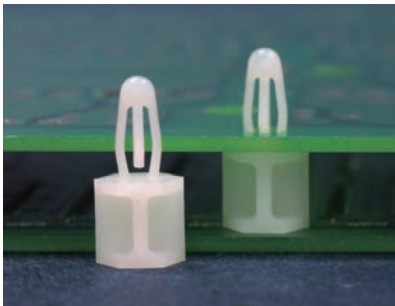

- Material: Nylon 66 (UL)
- Flame Class: 94V-2/94V-0
- Color: Natural/Black
- Unit: mm

用途：支撐PC板，使中間不致震動，載重而凹陷短路。

MOUNTING HOLE Ø4.2
THICKNESS 1.6

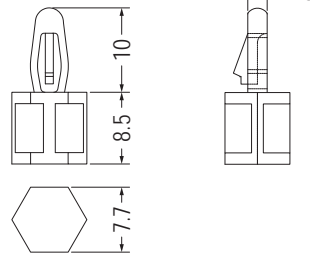

Part No.	Package
BSB-8.5	1000

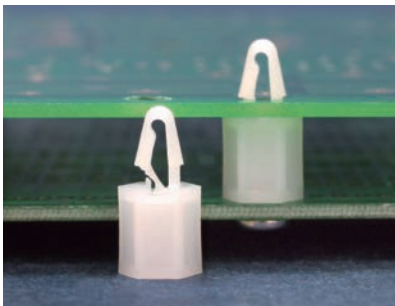

- Material: Nylon 66 (UL)
- Flame Class: 94V-2/94V-0
- Color: Natural/Black
- Unit: mm

用途：機板部份用M3.5鐵板自攻螺絲固定，另一頭直接壓入PC板。

MOUNTING HOLE Ø4.0
THICKNESS 1.6-2.0

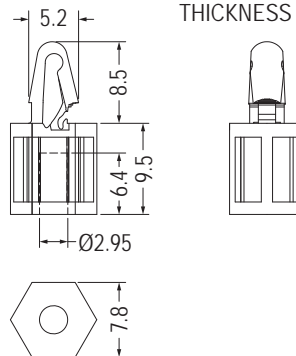

Part No.	Package
BSCL-9.5	1000

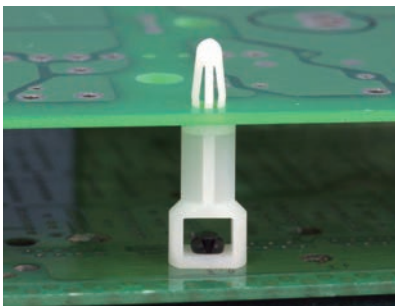

- Material: Nylon 66 (UL)
- Flame Class: 94V-2/94V-0
- Color: Natural/Black
- Unit: mm

用途：一端配合SR4系列鉚釘固定於機板上，一端固定於PC板上。

MOUNTING HOLE Ø4.0
THICKNESS 1.6

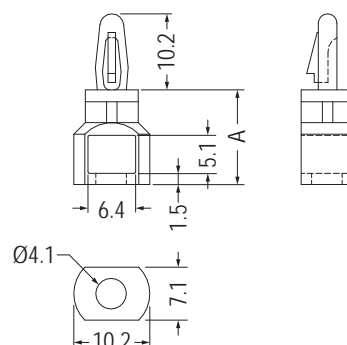

Part No.	A	Package
SRLCB-9	9.5	1000
SRLCB-11	11.1	
SRLCB-12	12.7	
SRLCB-15	15.9	
SRLCB-19.1	19.1	
SRLCB-22	22.2	
SRLCB-25	25.4	

PCB間隔柱 PCB SPACER

用途：一端配合SR4系列鉚釘固定於機板上，一端固定於PC板上。

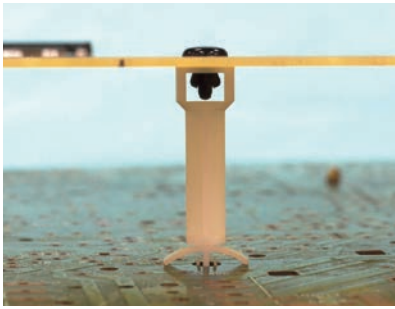

- Material: Nylon 66 (UL)
- Flame Class: 94V-2/94V-0
- Color: Natural/Black
- Unit: mm

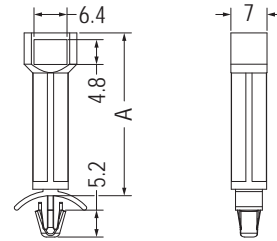
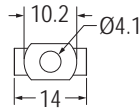

MOUNTING HOLE Ø4.75-Ø4.8
THICKNESS 0.8-2.0

Part No.	A	Package
SRLA-29.5	29.5	1000
SRLA-31.5	31.5	

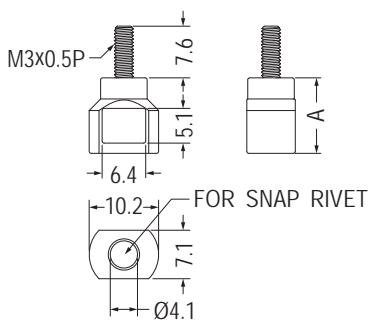

Part No.	A	Package
TCEB3-9.5	9.5	1000
TCEB3-11.1	11.1	

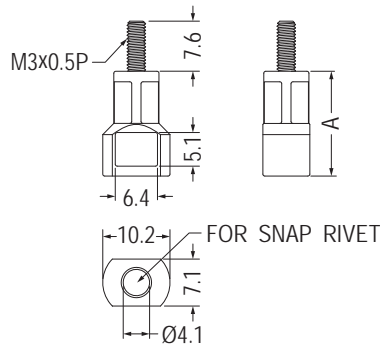

Part No.	A	Package
TCEB3-12.7	12.7	1000
TCEB3-15.9	15.9	
TCEB3-19.1	19.1	
TCEB3-22.2	22.2	
TCEB3-25.4	25.4	

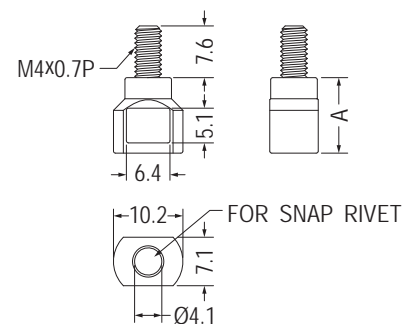

Part No.	A	Package
TCEB4-9.5	9.5	1000
TCEB4-11.1	11.1	

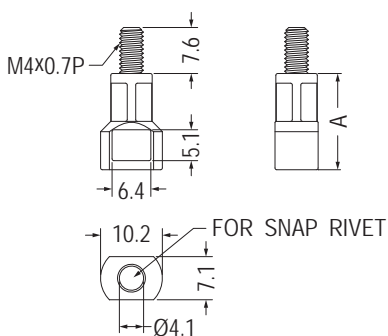

Part No.	A	Package
TCEB4-12.7	12.7	1000
TCEB4-15.9	15.9	
TCEB4-19.1	19.1	
TCEB4-22.2	22.2	
TCEB4-25.4	25.4	

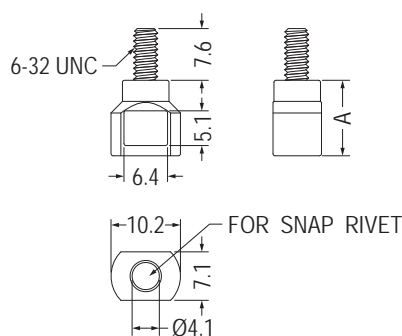

Part No.	A	Package
TCEB632-9.5	9.5	1000
TCEB632-11.1	11.1	

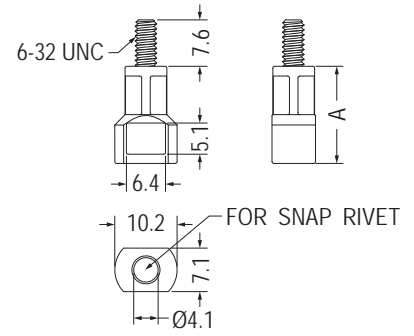

Part No.	A	Package
TCEB632-12.7	12.7	1000
TCEB632-15.9	15.9	
TCEB632-19.1	19.1	
TCEB632-22.2	22.2	
TCEB632-25.4	25.4	

PCB間隔柱 PCB SPACER

用途：機板部份用螺絲固定，另一頭直接壓入PC板。

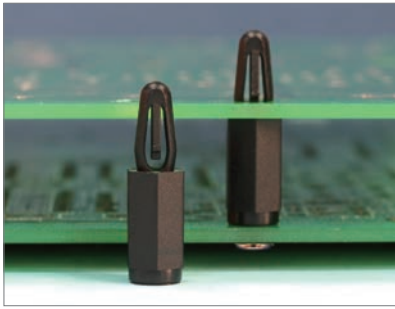

- Material: Nylon 66 (UL)
- Flame Class: 94V-2/94V-0
- Color: Natural/Black
- Unit: mm

MOUNTING HOLE Ø4.0
THICKNESS 1.6

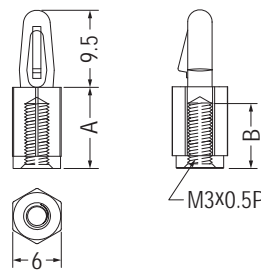

Part No.	A	B	Package
★BSCB-7	7.0	5.5	1000
BSCB-10	10.0	8.0	
BSCB-12	12.0	8.0	
★BSCB-14	14.0	10.0	
BSCB-15	15.0	10.0	
BSCB-25	25.0	10.0	

MOUNTING HOLE Ø4.0
THICKNESS 1.8

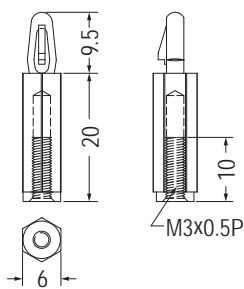

Part No.	Package
BSCB-20	1000

MOUNTING HOLE Ø4.0
THICKNESS 2.0

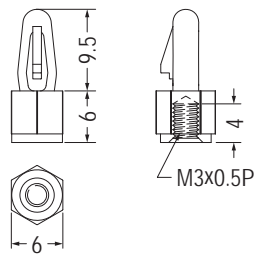

Part No.	Package
BSCB-6	1000

MOUNTING HOLE Ø4.0
THICKNESS 1.6

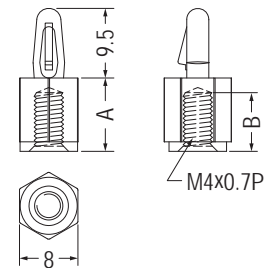

Part No.	A	B	Package
BSCB4-6	6.0	4.0	1000
BSCB4-8	8.0	6.0	
BSCB4-10	10.0	8.0	



- Material: Nylon 66 (UL)
- Flame Class: 94V-2/94V-0
- Color: Natural/Black
- Unit: mm

用途：機板部份用6-32鐵板自攻螺絲固定，另一頭直接壓入PC板。

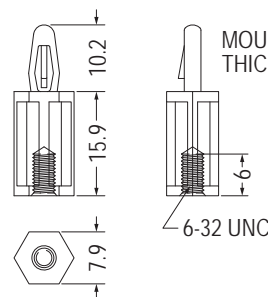

Part No.	Package
BSB632-15.9	1000

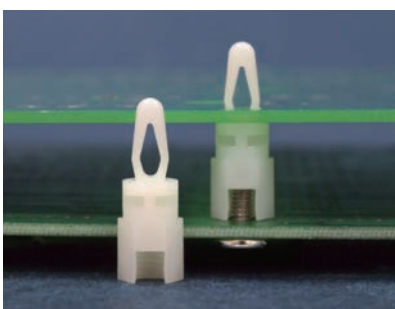

- Material: Nylon 66 (UL)
- Flame Class: 94V-2/94V-0
- Color: Natural/Black
- Unit: mm

用途：機板部份用螺絲固定，另一頭直接壓入PC板。

MOUNTING HOLE Ø4.0
THICKNESS 1.57

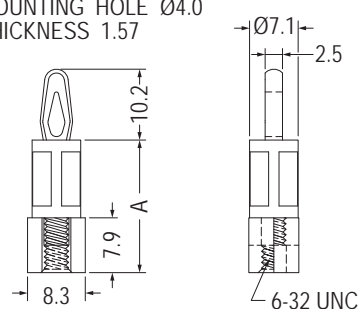

Part No.	A	Package
BSC632-9.5	9.5	1000
BSC632-12.7	12.7	
BSC632-15.9	15.9	
BSC632-19.1	19.1	
BSC632-22.2	22.2	
BSC632-25.4	25.4	

PCB間隔柱 PCB SPACER

用途：機板部份用螺絲固定，另一頭直接壓入PC板。

1

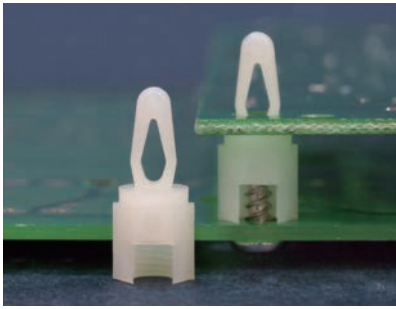

- Material: Nylon 66 (UL)
- Flame Class: 94V-2/94V-0
- Color: Natural/Black
- Unit: mm

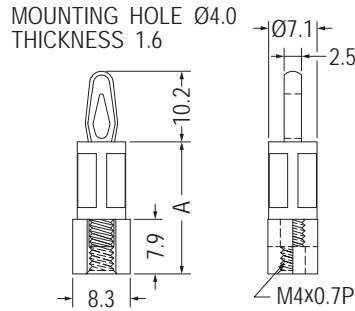

Part No.	A	Package
BSCM4-9.5	9.5	1000
BSCM4-12.7	12.7	
BSCM4-15.9	15.9	
BSCM4-19.1	19.1	
BSCM4-22.2	22.2	
BSCM4-25.4	25.4	

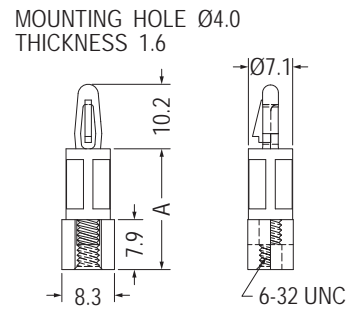
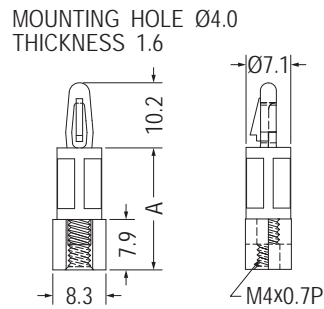
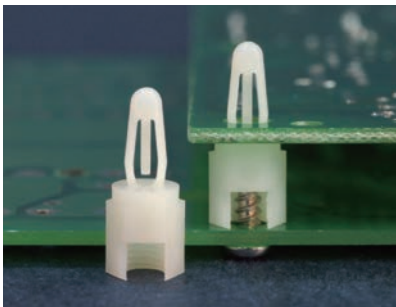

Part No.	A	Package
BSDM4-9.5	9.5	1000
BSDM4-12.7	12.7	
BSDM4-15.9	15.9	
BSDM4-19.1	19.1	
BSDM4-22.2	22.2	
BSDM4-25.4	25.4	

Part No.	A	Package
BSD632-9.5	9.5	1000
BSD632-12.7	12.7	
BSD632-15.9	15.9	
BSD632-19.1	19.1	
BSD632-22.2	22.2	
BSD632-25.4	25.4	

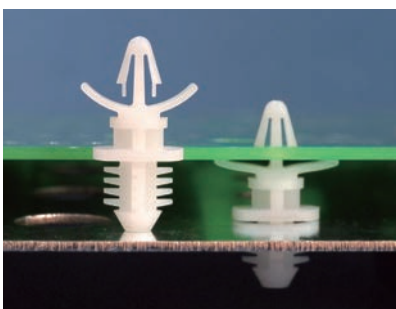

- Material: Nylon 66 (UL)
- Flame Class: 94V-2/94V-0
- Color: Natural/Black
- Unit: mm

用途：一端固定於木頭或音箱上，另一端固定於PC板上。

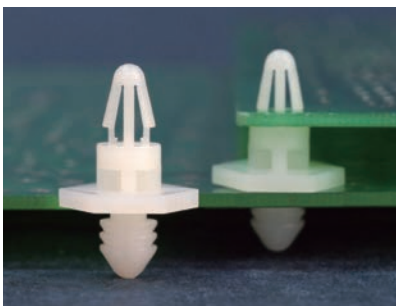
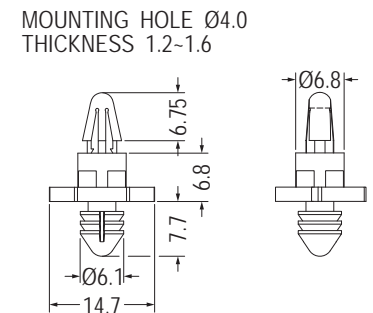
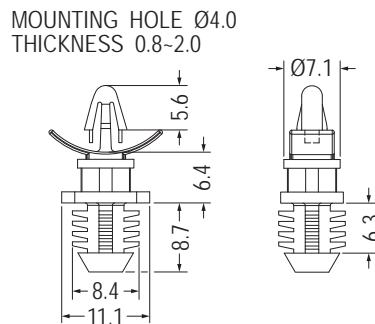

MOUNTING HOLE $\varnothing 7.9$
THICKNESS 6.4

MOUNTING HOLE $\varnothing 6.0$
THICKNESS 7.0

Part No.	Package
WBHC-6.4	1000

Part No.	Package
ACBW-6.8	1000

PCB間隔柱 PCB SPACER

用途：一端固定於木頭或音箱上，另一端固定於PC板上。

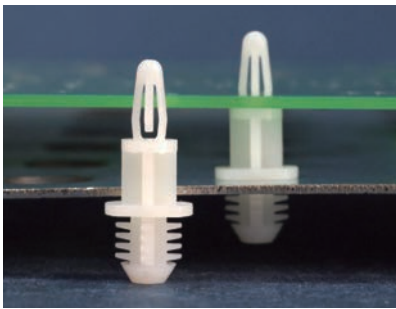

- Material: Nylon 66 (UL)
- Flame Class: 94V-2/94V-0
- Color: Natural/Black
- Unit: mm

MOUNTING HOLE $\varnothing 4.0$
THICKNESS 1.2-1.7

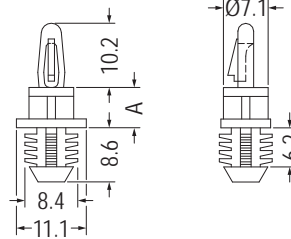

HOLE IN PANEL $\varnothing 7.9$
THICKNESS 6.4

Part No.	A	Package
WBH-5	4.8	1000
WBH-6	6.4	
WBH-9	9.5	
WBH-11	11.1	
WBH-12	12.7	
WBH-16	15.9	
WBH-19	19.1	
WBH-22	22.2	
WBH-25	25.4	

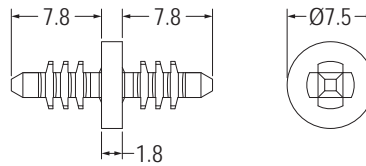
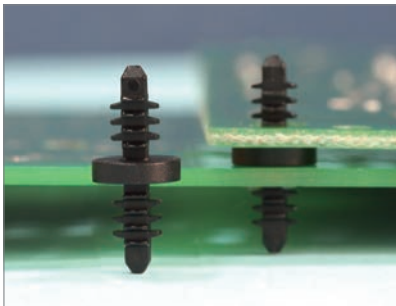

MOUNTING HOLE $\varnothing 4.0$
THICKNESS 2.6-6.3

Part No.	Package
WBHB-1.8	1000



- Material: Nylon 66 (UL)
- Flame Class: 94V-2/94V-0
- Color: Natural/Black
- Unit: mm

用途：一端固定於機板上，另一端支撐PC板，避免下陷造成短路，PC板免鑽孔。

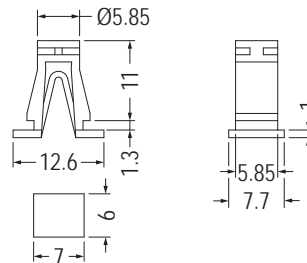

MOUNTING HOLE

Part No.	Package
PAA-11	1000

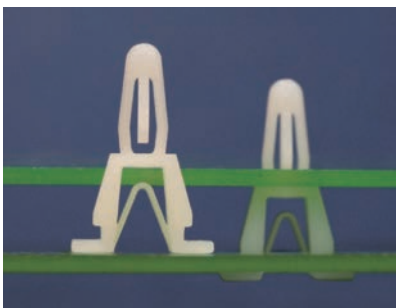

- Material: Nylon 66 (UL)
- Flame Class: 94V-2/94V-0
- Color: Natural/Black
- Unit: mm

用途：固定PC板於機板上，不會突出機板底部，外觀美麗。

MOUNTING HOLE $\varnothing 4.0$
THICKNESS 0.8-1.7

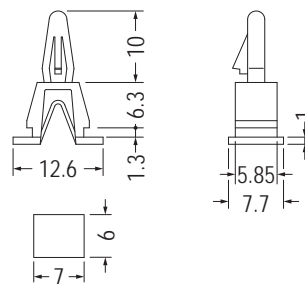

MOUNTING HOLE

Part No.	Package
PCC-6	2000

MOUNTING HOLE $\varnothing 4.0$
THICKNESS 1.2-1.7

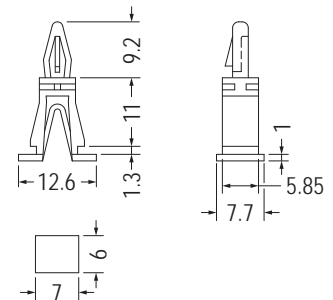

MOUNTING HOLE

Part No.	Package
PCC-11	1000

PCB間隔柱 PCB SPACER

用途：支撐PC板，使中間不致震動，載重而凹陷短路，吸震力強。

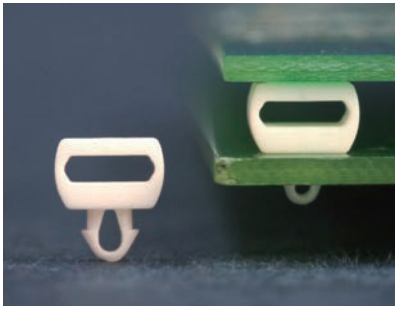

- Material: Nylon 66 (UL)
- Flame Class: 94V-2/94V-0
- Color: Natural/Black
- Unit: mm

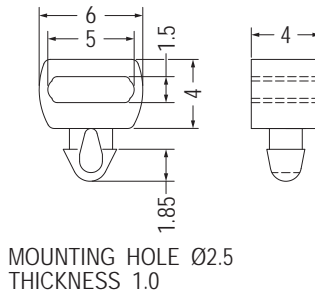

Part No.	Package
LIJ-4	2000

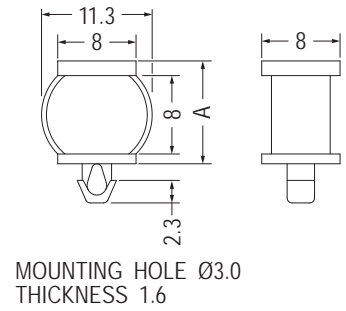

Part No.	A	Package
LIO-10	10.0	2000
LIO-10.5	10.5	

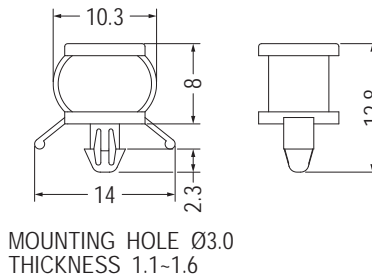
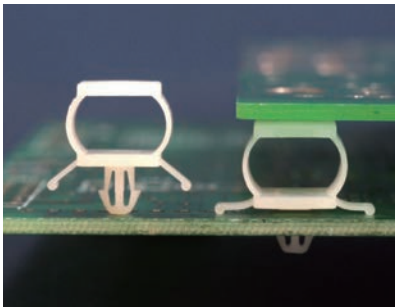

Part No.	Package
LIO-8	2000

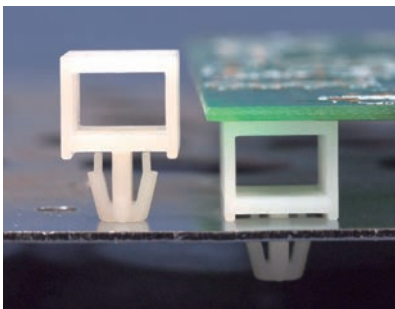

- Material: Nylon 66 (UL)
- Flame Class: 94V-2/94V-0
- Color: Natural/Black
- Unit: mm

用途：固定PC板於機板上，維修方便不佔空間。

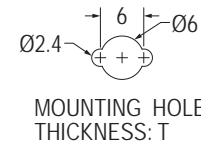
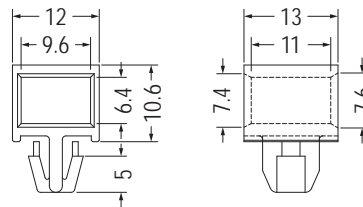

Part No.	T	Package
LDD-10	1.6~1.8	500
LDD-10(2)	1.8~2.0	

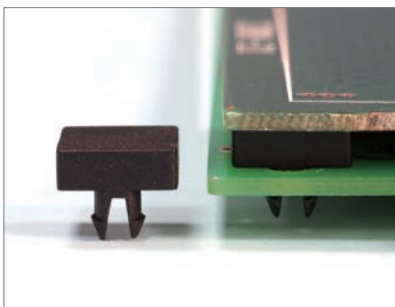

- Material: Nylon 66 (UL)
- Flame Class: 94V-2/94V-0
- Color: Natural/Black
- Unit: mm

用途：用於PC板墊高及支撐。

MOUNTING HOLE Ø3.8
THICKNESS 2.5

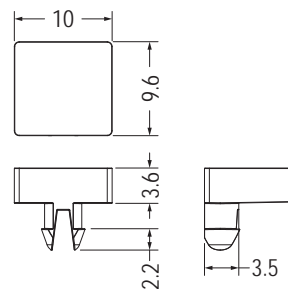

Part No.	Package
LIES-1	1000

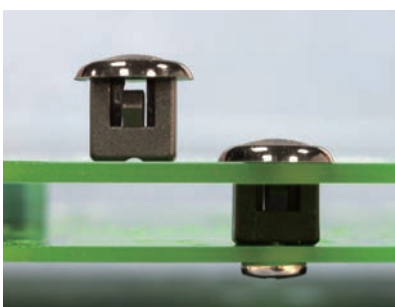

- Material: Nylon 66 (UL)
- Flame Class: 94V-2/94V-0
- Color: Natural/Black
- Unit: mm

用途：固定PC板於機板上，PC板用螺絲固定，易拆卸。

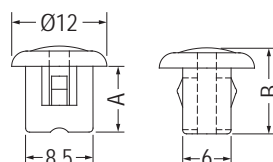

MOUNTING HOLE
THICKNESS 0.8~2.0

Part No.	A	B	Package
LHC-8	8.4	10.8	1000
LHC-12	12.5	14.9	

PCB間隔柱 PCB SPACER

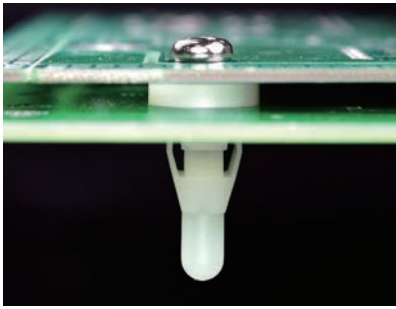

- Material: Nylon 66 (UL)
- Flame Class: 94V-2/94V-0
- Color: Natural/Black
- Unit: mm

用途：配合螺絲固定電漿面板於機殼上，可靠不脫落。

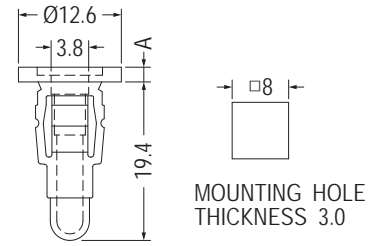
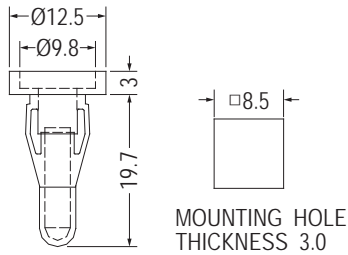

Part No.	Package
YES-3	500

Part No.	A	Package
YES-08	0.8	500
YES-32	3.2	
YES-48	4.8	

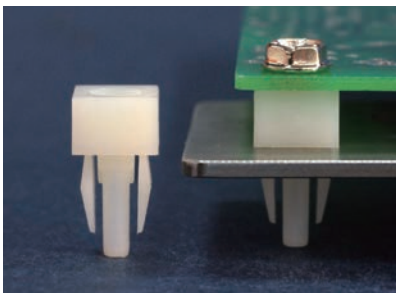

- Material: Nylon 66 (UL)
- Flame Class: 94V-2/94V-0
- Color: Natural/Black
- Unit: mm

用途：可搭配自攻牙螺絲用於PC板之固定。

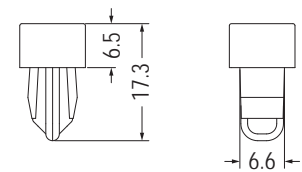
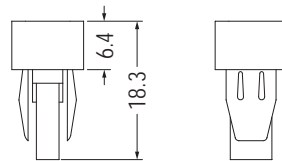
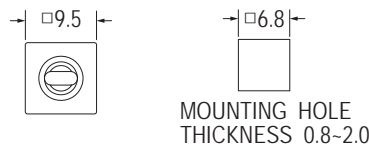

Part No.	Package
ES-1	2000

Part No.	Package
ES-2	1000

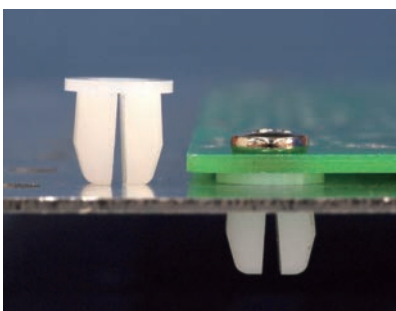
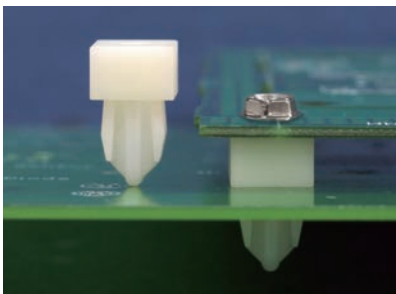

- Material: Nylon 66 (UL)
- Flame Class: 94V-2/94V-0
- Color: Natural/Black
- Unit: mm

用途：配合螺絲用於PC板之固定或當螺絲固定座。

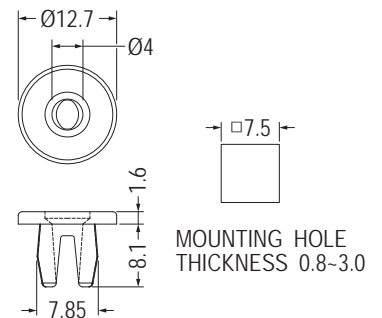
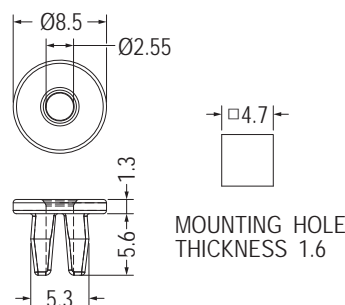
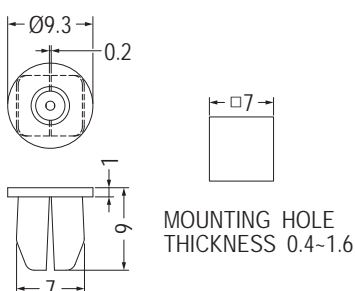

Part No.	Package
ESS-1	1000

Part No.	Package
ESS-3	1000

Part No.	Package
ESS-4	1000

PCB間隔柱 PCB SPACER

用途：配合螺絲用於PC板之固定。

1

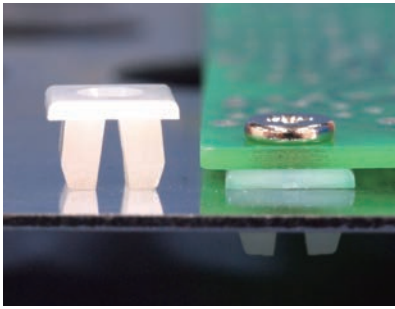

- Material: Nylon 66 (UL)
- Flame Class: 94V-2/94V-0
- Color: Natural/Black
- Unit: mm

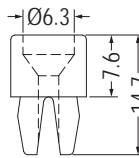
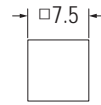
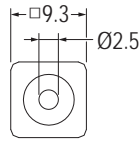

MOUNTING HOLE THICKNESS 2.4

Part No.	Package
ESS-7.6	1000

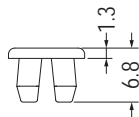
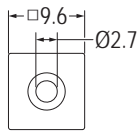

MOUNTING HOLE THICKNESS 0.8-3.2

Part No.	Package
ESS-2	1000

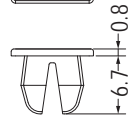
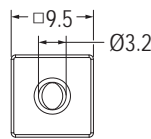

MOUNTING HOLE THICKNESS 2.8-3.2

Part No.	Package
ESS-5	1000

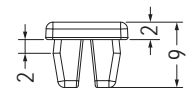
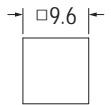
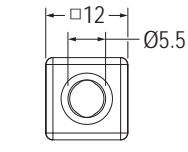

MOUNTING HOLE THICKNESS 1.5

Part No.	Package
ESS6-2.5	1000

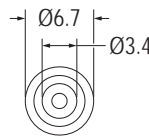
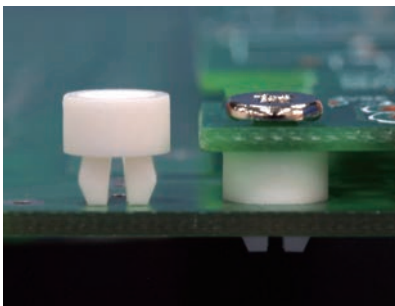

MOUNTING HOLE THICKNESS 1.0

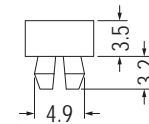

Part No.	Package
ETSA-3.5	1000

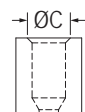
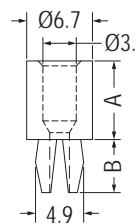
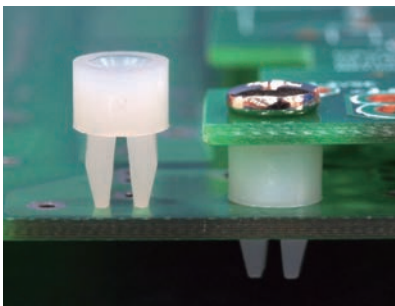

MOUNTING HOLE THICKNESS 2.0

Part No.	A	B	C	Package
ETS-3	3.0	5.4	4.4	2000
ETS-3-1	3.0	5.4	5.0	
ETS-3.2	3.2	5.4	4.4	
ETS-3.2-1	3.2	5.4	5.0	
ETS-3.2-2	3.2	4.0	5.0	
ETS-3.4	3.4	5.4	4.4	
ETS-3.6	3.6	5.4	5.0	
ETS-4.6	4.6	5.4	4.4	
ETS-4.8	4.8	5.4	4.4	
ETS-6.3	6.3	5.4	4.4	
ETSS-6.5	6.5	4.0	4.4	
ETS-7M	7.0	4.0		
ETS-7	7.0	5.0		
ETS-8	8.0	5.4	4.4	
ETS-10	10.0	5.4	4.4	
ETS-12	12.7	5.4	4.4	
ETS-16	15.9	5.4	4.4	
ETS-19	19.1	5.4	4.4	

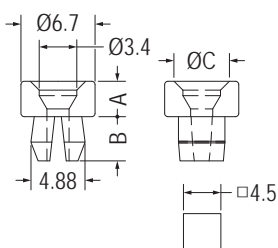

MOUNTING HOLE THICKNESS 2.3

【ETS-3.2-2】

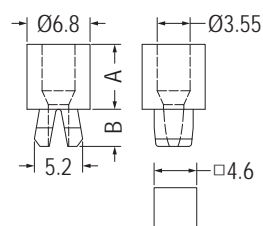

MOUNTING HOLE THICKNESS 3.0

【ETS-7M】

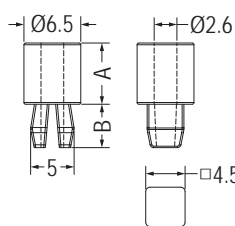

MOUNTING HOLE THICKNESS 2.38

【ETS-7】

PCB間隔柱 PCB SPACER

用途：配合螺絲用於PC板之固定。

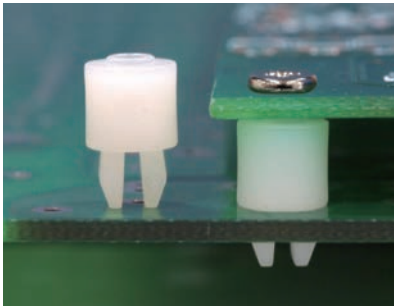

- Material: Nylon 66 (UL)
- Flame Class: 94V-2/94V-0
- Color: Natural/Black
- Unit: mm

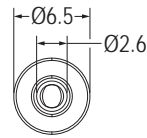

MOUNTING HOLE Ø3.7
FOR M2.5-M2.6 SCREW

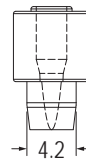
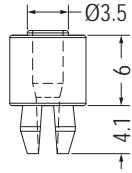

MOUNTING HOLE
THICKNESS 1.6



Part No.	Package
ETSB-6	1000

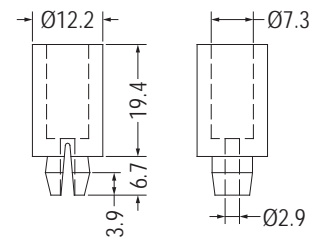

MOUNTING HOLE
THICKNESS 2.0



Part No.	Package
ESS-19	1000

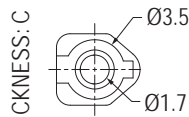
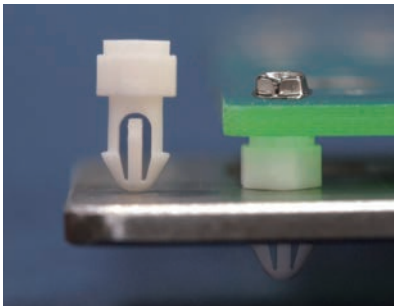
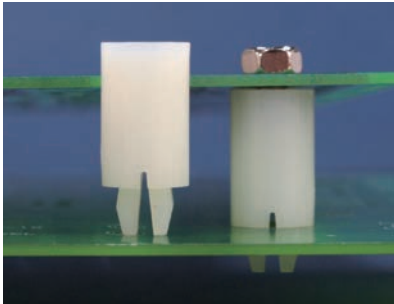

MOUNTING HOLE Ø3.0
THICKNESS: T

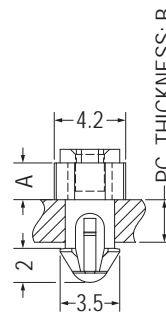
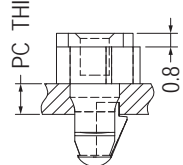

Part No.	A	B	C	T	Package
BSE-2.2	2.16	2.5	1.6	1.6-2.5	1000
BSE-2.2L	2.2	3.3	2.0	1.7-3.05	

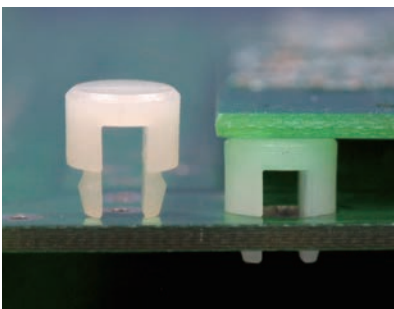

- Material: Nylon 66 (UL)
- Flame Class: 94V-2/94V-0
- Color: Natural/Black
- Unit: mm

用途：直接壓入板內固定。

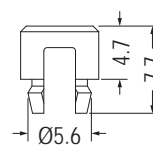

MOUNTING HOLE Ø5.0
THICKNESS 0.8

Part No.	Package
CUS-5	2000

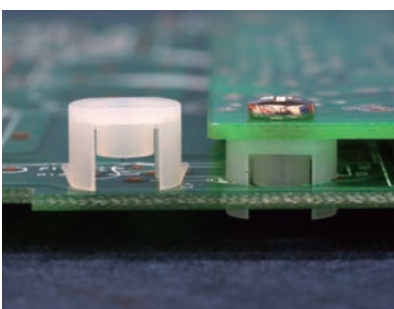

- Material: Nylon 66 (UL)
- Flame Class: 94V-2/94V-0
- Color: Natural/Black
- Unit: mm

用途：一頭直接壓入機板固定，另一頭用螺絲貫穿固定於機板，一般用於DVD內部之PC板固定。

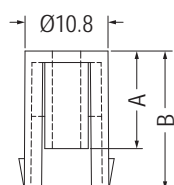
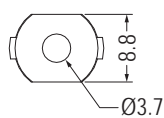

依照使用者的螺絲大小挖孔
(Hole must be based on the size of your screw)



MOUNTING HOLE
THICKNESS: T

Part No.	A	B	T	Package
DVDS-5	5.0	7.8	0.8-1.0	500
DVDS-9	9.4	14.7	0.8-1.2	
DVDS-12	12.7	18.1	0.8-1.2	

PCB間隔柱 PCB SPACER

用途：用於機器之面板固定，配合螺絲使用。

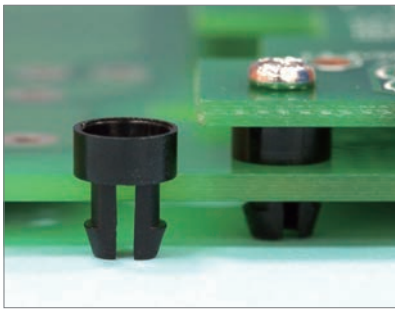

- Material: Nylon 66 (UL)
- Flame Class: 94V-2/94V-0
- Color: Natural/Black
- Unit: mm

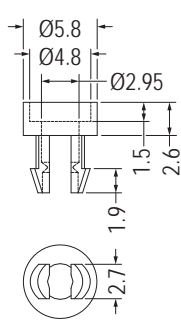

MOUNTING HOLE Ø4.0
THICKNESS 2.3-2.5

Part No.	Package
SOR-2	2000

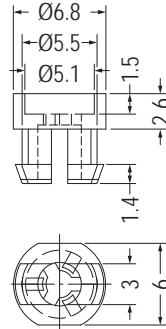
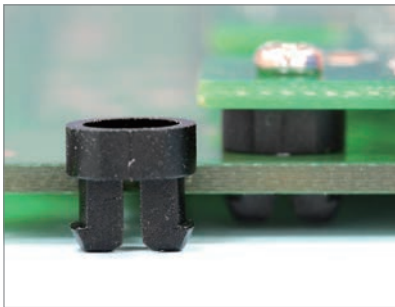

MOUNTING HOLE Ø5.5
THICKNESS 2.3-2.5

Part No.	Package
SOR-1	2000

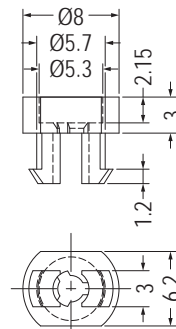

FOR M2.5 or M2.6 SCREW

Part No.	Package
SOR-3	2000

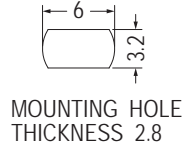

- Material: Nylon 66 (UL)
- Flame Class: 94V-2/94V-0
- Color: Natural/Black
- Unit: mm

用途：固定PC板於機板上，免工具，易拆卸。

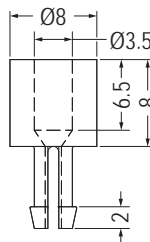

MOUNTING HOLE Ø3.5
THICKNESS 5.5

Part No.	Package
SSUL-8	1000

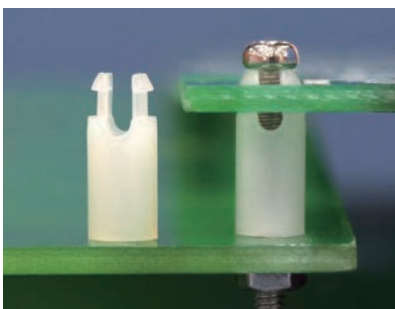

- Material: Nylon 66 (UL)
- Flame Class: 94V-2/94V-0
- Color: Natural/Black
- Unit: mm

用途：快速固定PC板於機板上，如配合螺絲可將PC板固定於木板上。

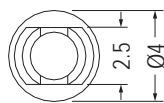

MOUNTING HOLE Ø3.0
THICKNESS: T

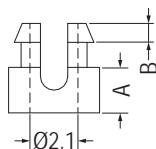

FOR M2 SCREW

MOUNTING HOLE Ø3.0
THICKNESS 1.3

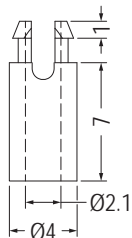

FOR M2 SCREW

Part No.	Package
SS3-7(1.3)	1000

Part No.	A	B	T	Package
SS1-2	2.0	1.2	0.8-1.0	2000
SS1-2.5	2.5	1.2	0.8-1.0	
SS1-3	3.0	1.2	0.8-1.0	
SS1-3.5	3.5	1.2	0.8-1.0	
SS1-4	4.0	1.2	0.8-1.0	
SS1-4.5	4.5	1.2	0.8-1.0	
SS1-5	5.0	1.2	0.8-1.0	
SS1-5.5	5.5	1.2	0.8-1.0	
SS1-6	6.0	1.2	0.8-1.0	
SS1-2L	2.0	1.0	1.6	
SS1-2.5L	2.5	1.0	1.6	
SS1-3L	3.0	1.0	1.6	

Part No.	A	B	T	Package
SS1-2S	2.0	0.5	0.8-1.0	2000
SS1-2.5S	2.5	0.5	0.8-1.0	
SS1-3S	3.0	0.5	0.8-1.0	
SS1-3.5S	3.5	0.5	0.8-1.0	
SS1-4S	4.0	0.5	0.8-1.0	
SS1-4.5S	4.5	0.5	0.8-1.0	
SS1-5S	5.0	0.5	0.8-1.0	
SS1-5.5S	5.5	0.5	0.8-1.0	
SS1-6S	6.0	0.5	0.8-1.0	
SS1-2L	2.0	1.0	1.6	
SS1-2.5L	2.5	1.0	1.6	
SS1-3L	3.0	1.0	1.6	
SS1-3.5L	3.5	1.0	1.6	
SS1-4L	4.0	1.0	1.6	
SS1-4.5L	4.5	1.0	1.6	
SS1-5L	5.0	1.0	1.6	
SS1-5.5L	5.5	1.0	1.6	
SS1-6L	6.0	1.0	1.6	
SS1-8L	8.0	1.0	1.6	
SS1-9L	9.0	1.0	1.6	

PCB間隔柱 PCB SPACER

用途：快速固定PC板於機板上，如配合螺絲可將PC板固定於木板上。

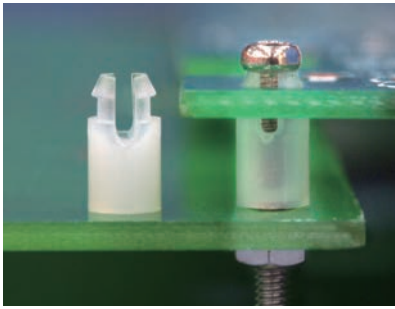

- Material: Nylon 66 (UL)
- Flame Class: 94V-2/94V-0
- Color: Natural/Black
- Unit: mm

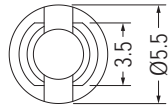

MOUNTING HOLE Ø4.0
THICKNESS: T

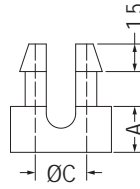

FOR SCREW

Part No.	A	C	T	Screw	Package
SS2-2.5U	2.5	2.1	1.6-1.8	M2	2000
SS2-2.5S	2.5	2.7	1.6	M2.6	
SS2-3S	3.0	2.7	1.6	M2.6	
SS2-4S	4.0	2.7	1.6	M2.6	
SS2-5S	5.0	2.7	1.6	M2.6	
SS2-6S	6.0	2.7	1.6	M2.6	
SS2-2.5	2.5	2.8	1.6-1.8	M2.6	
SS2-3	3.0	2.8	1.6-1.8	M2.6	
SS2-4	4.0	2.8	1.6-1.8	M2.6	
SS2-5	5.0	2.8	1.6-1.8	M2.6	
SS2-5.4	5.4	2.8	1.6-1.8	M2.6	
SS2-6	6.0	2.8	1.6-1.8	M2.6	
SS2-8	8.0	2.8	1.6-1.8	M2.6	
SS2-9.5	9.5	2.8	1.6-1.8	M2.6	

MOUNTING HOLE Ø4.8
THICKNESS 1.0-1.2

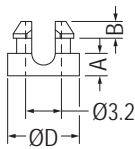

FOR M3 SCREW

【 SS-2S 】

Part No.	A	B	D	Package
SS-2S	2.0	1.5	6.4	1000
SS-2.4	2.4	1.5	6.4	
SS-3	3.2	1.5	6.4	
SS-3.5	3.5	1.5	6.4	
SS-4	4.0	1.5	6.4	
SS-4.5	4.5	1.5	6.4	

MOUNTING HOLE Ø4.8
THICKNESS 1.2-1.7

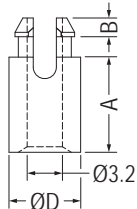

FOR M3 SCREW

【 SS-10A 】

Part No.	A	B	D	Package
SS-5	4.8	1.5	6.4	1000
SS-5A	5.0	1.5	6.4	
SS-6	6.4	1.5	6.4	
SS-7	7.0	1.5	6.5	
SS-7.4	7.4	1.7	6.5	
SS-8	7.9	1.5	6.4	

MOUNTING HOLE Ø4.8
THICKNESS 1.2-1.7

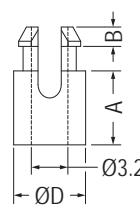

FOR M3 SCREW

Part No.	A	B	D	Package
SS-10	9.5	1.5	6.4	1000
SS-10A	9.5	1.7	6.5	
SS-11	11.1	1.5	6.4	
SS-12A	12.0	1.5	6.4	
SS-12	12.7	1.5	6.4	
SS-14	14.2	1.5	6.4	
SS-14.5	14.55	1.5	6.4	
SS-15	15.0	1.5	6.4	
SS-16	15.9	1.5	6.4	
SS-17.2	17.2	1.5	6.4	
SS-19	19.1	1.5	6.4	
SS-22	22.2	1.5	6.4	500
SS-25	25.4	1.5	6.4	

MOUNTING HOLE Ø4.8
THICKNESS 1.6

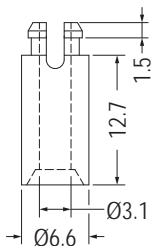

FOR M3 SCREW

Part No.	Package
SSA-12.7	1000

MOUNTING HOLE Ø5.8
THICKNESS 1.6

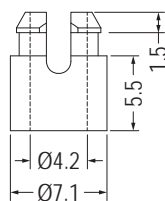

FOR M3.5 or M4 SCREW

Part No.	Package
SSA4-5.5	1000

MOUNTING HOLE Ø5.9
THICKNESS: T

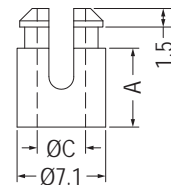

FOR M4 SCREW

Part No.	A	C	T	Package
SSU4-6.3	6.35	3.9	1.2-1.7	1000
SSU4-6.3L	6.35	4.3	1.6	
SSU4-9.5	9.5	3.9	1.2-1.7	
SSU4-9.5L	9.53	4.3	1.6	
SSU4-12.7	12.7	3.9	1.2-1.7	
SSU4-12.7L	12.7	4.3	1.6	
SSU4-15.9	15.9	3.9	1.2-1.7	

PCB間隔柱 PCB SPACER

用途：快速固定PC板於機板上，如配合螺絲可將PC板固定於木板上。

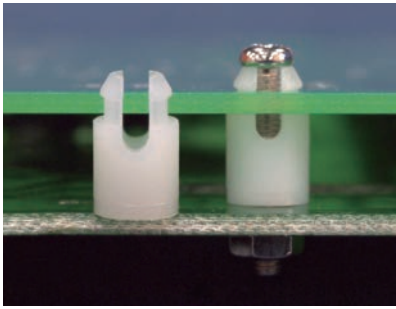

- Material: Nylon 66 (UL)
- Flame Class: 94V-2/94V-0
- Color: Natural/Black
- Unit: mm

MOUNTING HOLE Ø5.9
THICKNESS 1.8

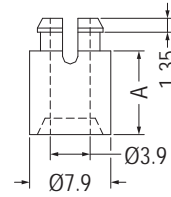

FOR M3.5 SCREW

Part No.	A	Package
SS3.5-6.3	6.3	1000
SS3.5-9.5	9.5	
SS3.5-12.7	12.7	
SS3.5-15	15.9	

MOUNTING HOLE Ø5.9
THICKNESS 1.8

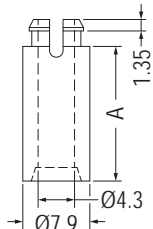

FOR M4 SCREW
【 SS4-8L, SS4-16L 】

MOUNTING HOLE Ø5.9
THICKNESS 1.2-1.7

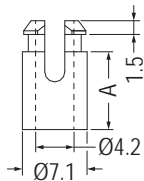

FOR M3.5 or M4 SCREW

Part No.	A	Package
SS4-3	3.0	1000
SS4-4	4.0	
SS4-4.6	4.6	
SS4-5	5.0	

Part No.	A	Package
SS4-6	6.4	1000
SS4-8	7.9	
★SS4-8L	7.95	
SS4-9	9.5	
SS4-11	11.1	
SS4-12S	12.0	
SS4-12	12.7	
SS4-16	15.9	
SS4-16L	15.9	
SS4-17	17.0	
SS4-19	19.1	500
SS4-22	22.2	
SS4-25	25.4	
SS4-30	30.0	

MOUNTING HOLE Ø6.0
THICKNESS 1.6

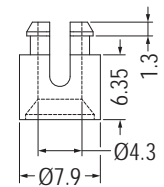

FOR M4 SCREW

Part No.	Package
SSUA4-6.3L	1000

PCB固定座 PCB MOUNTING BLOCK

用途：用於主機板或PC板固定。

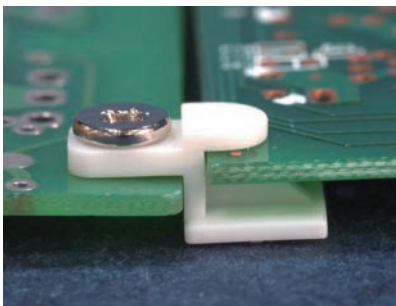

- Material: Nylon 66 (UL)
- Flame Class: 94V-2/94V-0
- Color: Natural/Black
- Unit: mm

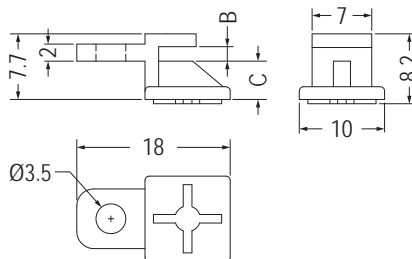

Part No.	B	C	Package
UBD-1	1.7	4.5	1000
UBD-2	2.0	4.15	

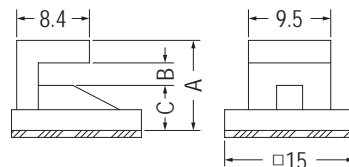
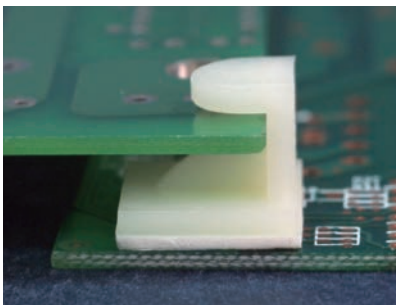

3M DOUBLE ADHESIVE TAPE
A尺寸不含背膠高度

Part No.	A	B	C	Package
UB-6A	10.4	2.6	5.1	1000
UB-8A	11.9	2.4	7.0	
UB-10A	14.1	2.5	9.1	
UB-11A	15.0	2.5	10.0	
UB-12A	16.1	2.5	11.1	

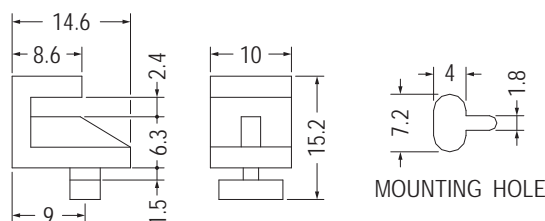
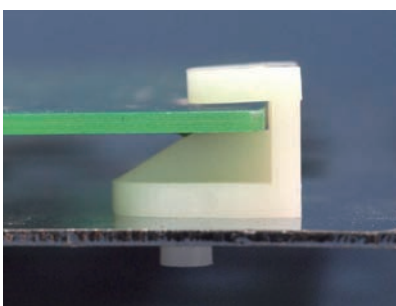

Part No.	Package
UB-6E	1000

用途：用於主機板或PC板固定。

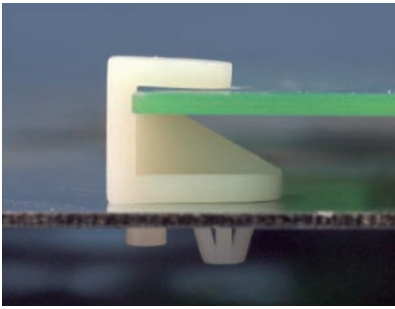

- Material: Nylon 66 (UL)
- Flame Class: 94V-2/94V-0
- Color: Natural/Black
- Unit: mm

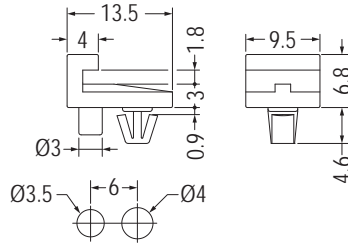

MOUNTING HOLE THICKNESS 0.8

Part No.	Package
UB-3S	1000

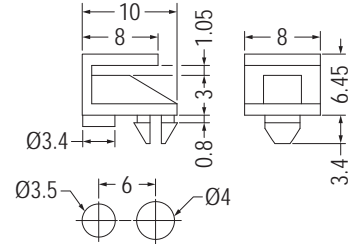

MOUNTING HOLE THICKNESS 0.8

Part No.	Package
UB-4	1000

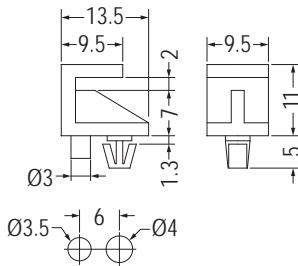

MOUNTING HOLE THICKNESS 1.0

Part No.	Package
UB-6	1000

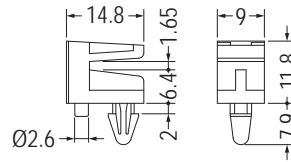

MOUNTING HOLE THICKNESS 1.6

Part No.	Package
UB-6D	1000

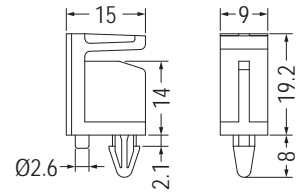

MOUNTING HOLE THICKNESS 1.6

Part No.	Package
UB-14D	1000

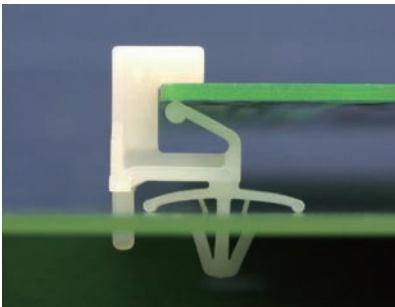

- Material: Nylon 66 (UL)
- Flame Class: 94V-2/94V-0
- Color: Natural/Black
- Unit: mm

用途：支撐PC板，使中間不致震動，載重而凹陷短路。

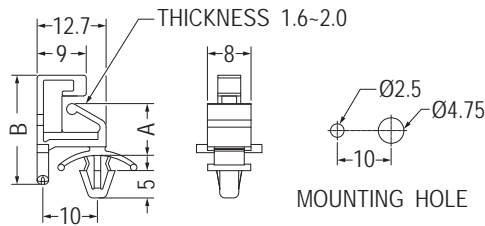

MOUNTING HOLE Ø4.8 THICKNESS 0.8-2.0

Part No.	A	B	Package
WLCF-6	6.3	16.8	1000
WLCF-8	8.0	18.5	
WLCF-9	9.5	20.0	
WLCF-12	12.7	23.2	500
WLCF-16	15.9	26.4	

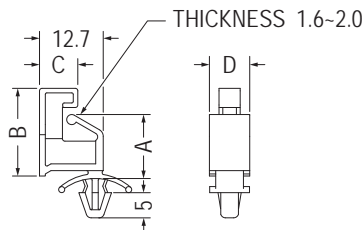
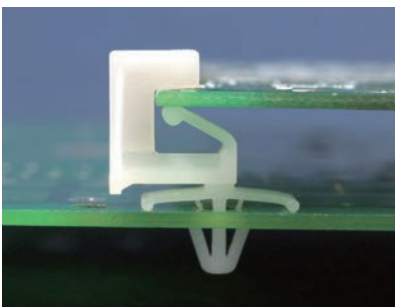

MOUNTING HOLE Ø4.8 THICKNESS 0.8-2.0

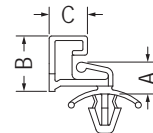

【 ULCF-6-ULCF-8S 】

Part No.	A	B	C	D	Package
ULCF-6	6.3	11.0	9.0	8.0	1000
ULCF-8	8.0	12.7	9.0	8.0	
ULCF-8S	8.0	12.7	7.6	6.0	
ULCF-9	9.5	14.2	9.0	8.0	
ULCF-12	12.7	17.4	9.0	8.0	
ULCF-16	15.9	20.6	9.0	8.0	

PCB間隔柱 PCB SPACER

1

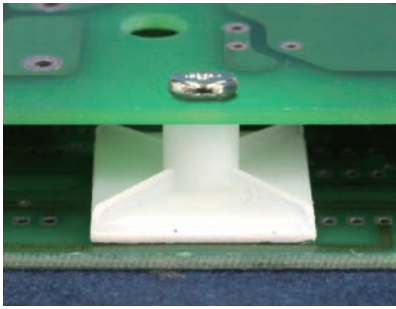

- Material: Nylon 66 (UL)
- Flame Class: 94V-2/94V-0
- Color: Natural/Black
- Unit: mm

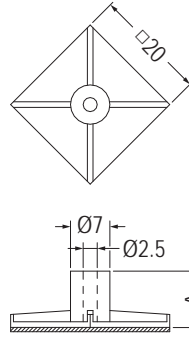

3M DOUBLE ADHESIVE TAPE
A 尺寸不含背膠高度

用途：背膠式，用於不能鑽孔之機板與PC板間之固定，配合螺絲使用，拆卸方便。

Part No.	A	Package
ASR-5	4.2	500
ASR-6	5.6	
ASR-7	6.2	
ASR-8	7.2	
ASR-9	8.2	
ASR-11	10.0	
ASR-12.7	11.9	
ASR-14.5	13.6	
ASR-15.9	15.1	
ASR-17.5	16.3	
ASR-19.1	18.3	

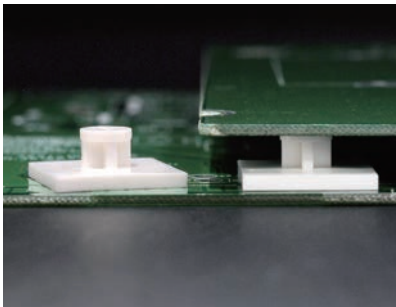

- Material: Nylon 66 (UL)
- Flame Class: 94V-2/94V-0
- Color: Natural/Black
- Unit: mm

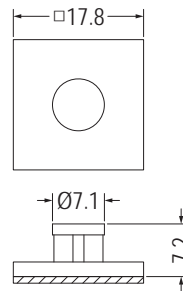

3M DOUBLE ADHESIVE TAPE
高度尺寸不含背膠高度

用途：背膠式，用於不能鑽孔之機板與PC板間之固定。

Part No.	Package
AST-7.2	500

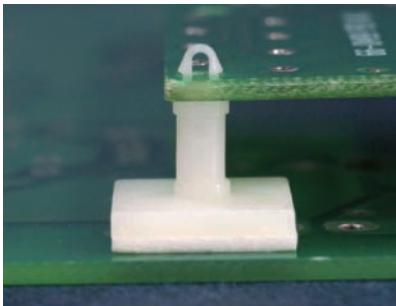

MOUNTING HOLE Ø2.0
THICKNESS 1.6

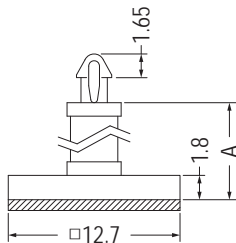

3M DOUBLE ADHESIVE TAPE
A 尺寸不含背膠高度

Part No.	A	Package
ISS-4.8	4.0	1000
ISS-6.4	5.6	
ISS-8	7.2	
ISS-9.5	8.7	
ISS-11.1	10.3	
ISS-12.7	11.9	
ISS-15.9	15.1	
ISS-19.1	18.3	

MOUNTING HOLE Ø2.5
THICKNESS 1.6

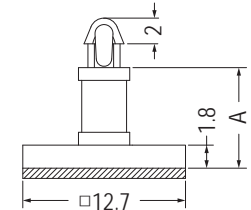

3M DOUBLE ADHESIVE TAPE
A 尺寸不含背膠高度

Part No.	A	Package
GSS-4.8	4.0	1000
GSS-6.4	5.6	
GSS-8	7.2	
GSS-9.5	8.7	
GSS-11.1	10.3	
GSS-12.7	11.9	
GSS-14.3	13.5	
GSS-15.9	15.1	
GSS-19.1	18.3	



MOUNTING HOLE Ø3.0
THICKNESS 1.2-1.7

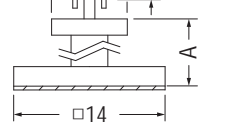

3M DOUBLE ADHESIVE TAPE
A 尺寸不含背膠高度

• Patented (專利品)

Part No.	A	Package
BSS-6	5.6	1000
BSS-9	8.0	
BSS-12	11.9	

PCB間隔柱 PCB SPACER

用途：背膠式，用於不能鑽孔之機板與PC板間之固定。

- Material: Nylon 66 (UL)
- Flame Class: 94V-2/94V-0
- Color: Natural/Black
- Unit: mm

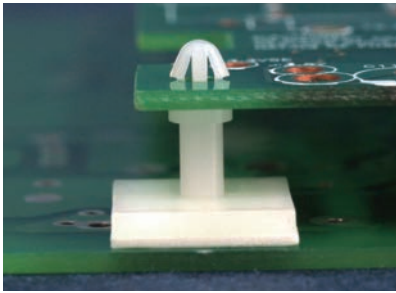

MOUNTING HOLE Ø3.0
THICKNESS 1.6

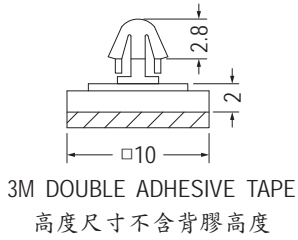

Part No.	Package
CSSA-2	1000

MOUNTING HOLE Ø3.0
THICKNESS 1.2-1.6

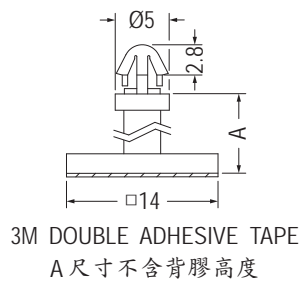

Part No.	A	Package
CSS-3.5	2.7	1000
CSS-5	4.0	
CSS-6.4	5.6	
CSS-8	7.2	
CSS-10	9.2	
CSS-11	9.7	
CSS-12.7	11.9	

MOUNTING HOLE Ø3.5
THICKNESS 1.2-1.6

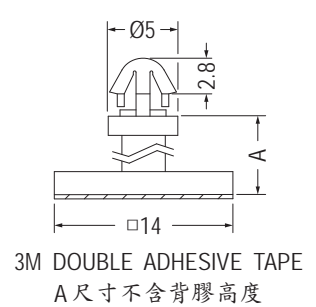

Part No.	A	Package
FSS-3.5	2.7	1000
FSS-5	4.0	
FSS-6.4	5.6	
FSS-8	7.2	
FSS-10	9.2	
FSS-12.7	11.9	

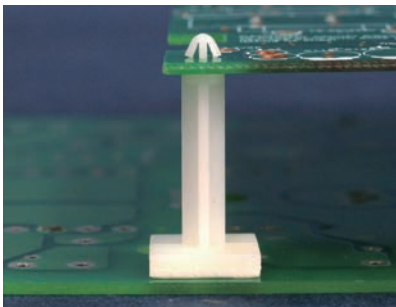

MOUNTING HOLE Ø3.5
THICKNESS 1.2-1.6

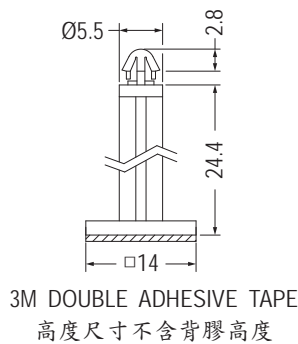

Part No.	Package
FSL-25	1000



MOUNTING HOLE Ø3.5
THICKNESS 2.4

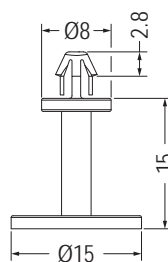

Part No.	Package
FSSA-15	1000

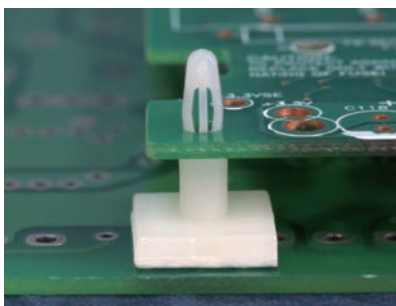

MOUNTING HOLE Ø3.2
THICKNESS 1.6

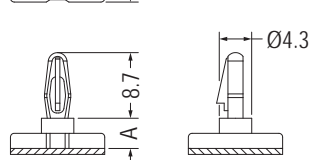

Part No.	A	Package
JSS-4.8	4.0	500
JSS-6.4	5.6	
JSS-7.9	6.8	
JSS-8.4	7.5	
JSS-9.5	8.5	
JSS-11	10.6	
JSS-12.7	11.7	
JSS-15.9	15.0	

PCB間隔柱 PCB SPACER

用途：背膠式，用於不能鑽孔之機板與PC板間之固定。

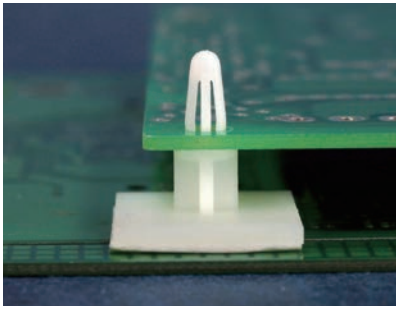

- Material: Nylon 66 (UL)
- Flame Class: 94V-2/94V-0
- Color: Natural/Black
- Unit: mm

• 背膠高度以0.9為標準

Part No.	A	B	C	D	F	T	Package
ASS-5	4.6	10.0	20.0	5.5	7.0	1.2~1.7	500
ASS-6	5.5	10.0	20.0	6.4	7.0	1.2~1.7	
ASS-6L	5.5	10.2	17.8	6.4	6.9	1.2~1.6	
ASS-8	7.2	10.0	20.0	8.1	7.0	1.2~1.7	
ASS-9.5L	8.6	10.2	17.8	9.5	7.0	1.2~1.6	
ASS-10	9.0	10.0	20.0	9.9	7.0	1.2~1.7	
ASS-12.7L	11.8	10.2	18.0	12.7	6.9	1.2~1.6	
ASS-12	12.0	10.0	20.0	12.9	7.0	1.2~1.7	
ASS-15	15.4	10.0	20.0	16.3	7.0	1.2~1.7	
ASS-15.3S	15.3	8.0	17.8	16.2	7.1	1.2~1.6	
ASS-15.9L	15.0	10.2	18.0	15.9	6.9	1.2~1.6	
ASS-18.5	18.5	10.0	18.0	19.4	6.8	1.2~2.0	

MOUNTING HOLE Ø4.0
THICKNESS: T

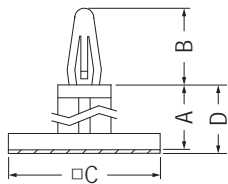

3M DOUBLE ADHESIVE TAPE
A尺寸不含背膠高度

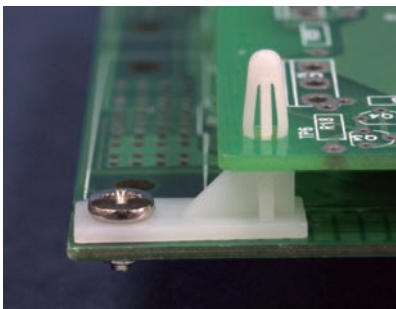
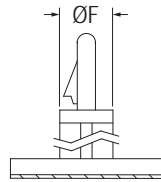

- Material: Nylon 66 (UL)
- Flame Class: 94V-2/94V-0
- Color: Natural/Black
- Unit: mm

用途：機板部分用螺絲固定，另一頭直接壓入PC板。

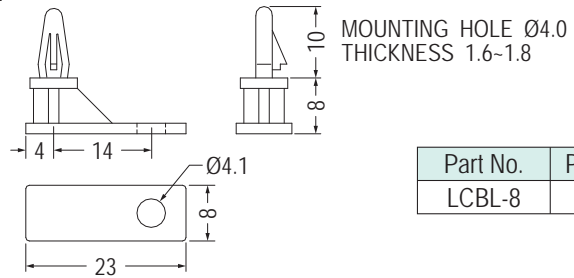

Part No.	Package
LCBL-8	1000

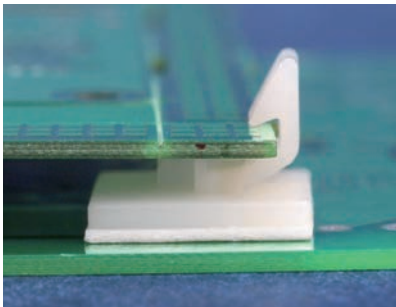

- Material: Nylon 66 (UL)
- Flame Class: 94V-2/94V-0
- Color: Natural/Black
- Unit: mm

用途：背膠式，用於不能鑽孔之機板與PC板間之固定。

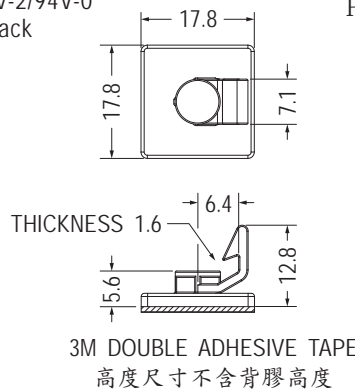

Part No.	Package
ULCK-6.4	1000



- Material: Nylon 66 (UL)
- Flame Class: 94V-2/94V-0
- Color: Natural/Black
- Unit: mm

用途：背膠式，用於PC板端直接壓入固定。



Part No.	Package
ULCKA-15.6	1000

3M DOUBLE ADHESIVE TAPE
高度尺寸不含背膠高度

PCB間隔柱 PCB SPACER

用途：PC板直接壓入固定，另一頭用螺絲固定，省時易拆卸。



- Material: Nylon 66 (UL)
- Flame Class: 94V-2/94V-0
- Color: Natural/Black
- Unit: mm

MOUNTING HOLE Ø2.5
THICKNESS 1.0

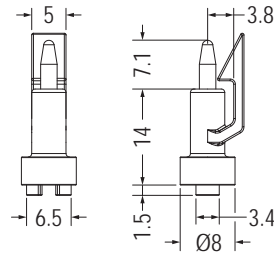

Part No.	Package
ULCI-11	1000



MOUNTING HOLE Ø4.0
THICKNESS 1.2-1.6

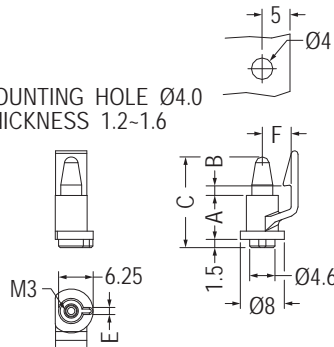

Part No.	A	B	C	E	F	Package
ULCC-6	6.3	1.73	14.8	1.3	5.25	500
ULCC-8	8.0	1.7	16.5	1.3	5.25	
ULCC-10	10.0	2.24	19.0	1.4	5.25	
ULCC-12	12.0	1.75	19.8	1.4	5.25	
ULCC-19	18.55	1.9	27.05	1.3	5.5	



MOUNTING HOLE Ø2.5
THICKNESS 1.0

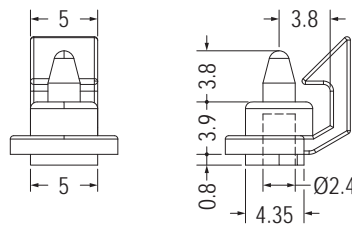

Part No.	Package
ULCIJ-4	1000



MOUNTING HOLE Ø3.3
THICKNESS 1.0

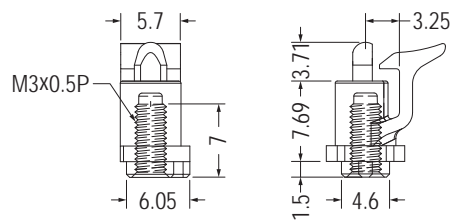

Part No.	Package
ULCD-7.8	1000

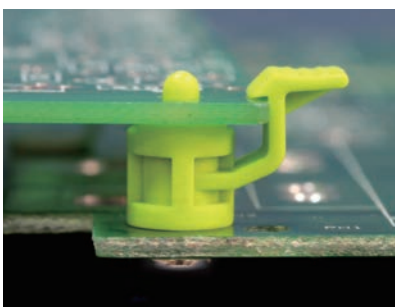

MOUNTING HOLE Ø3.3
THICKNESS 1.6

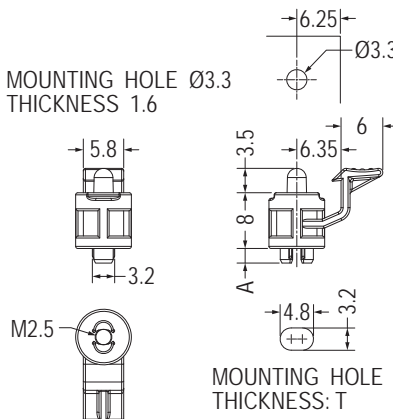

- Color: Natural/Black/Green

Part No.	A	T	Package
ULCH-2	2.1	2.16	1000
ULCH-2S	1.5	1.6	

PCB間隔柱 PCB SPACER

用途：PC板與PC板之固定，加強導電幫助接地，不佔空間。

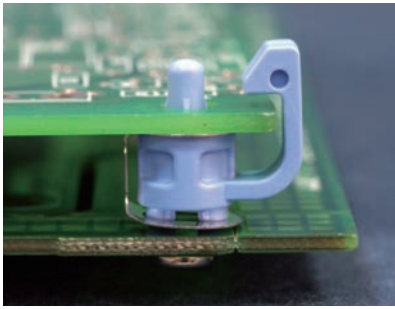

- Material: Nylon 66 (UL)
- Ground Terminal Material: SPTE
- Flame Class: 94V-2/94V-0
- Color: Natural/Black/Blue
- Unit: mm

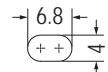
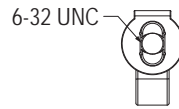
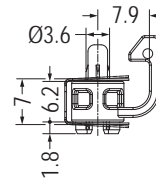
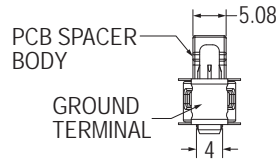
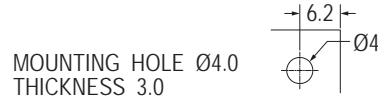

Part No.	Package
ULCH-1	1000

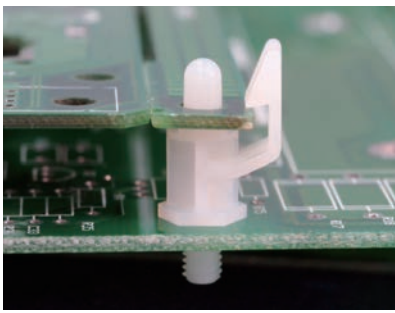

- Material: Nylon 66 (UL)
- Flame Class: 94V-2/94V-0
- Color: Natural/Black
- Unit: mm

用途：PC板直接壓入固定，另一端可配合螺絲或攻牙。

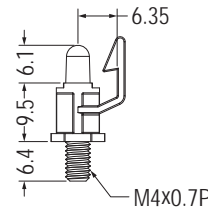
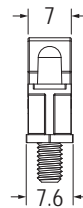

Part No.	Package
ULCBM4-9.5	1000



- Material: Nylon 66 (UL)
- Flame Class: 94V-2/94V-0
- Color: Natural/Black
- Unit: mm

用途：PC板直接壓入固定，另一頭直接壓入機板固定，省時易拆裝。

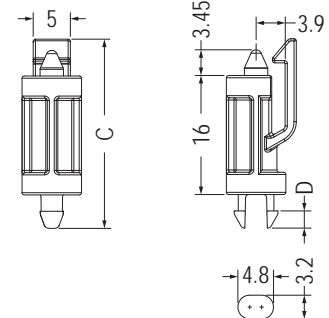
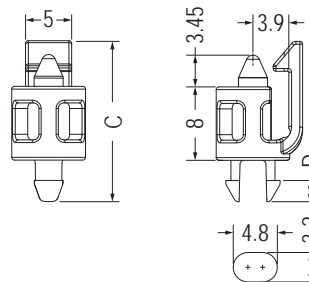
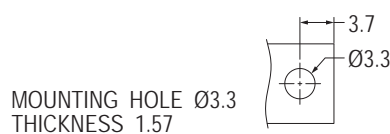

Part No.	C	D	T	Package
ULCSA-8	17.45	2.3	2.13	1000
ULCSA-8S	16.5	1.9	1.57	

Part No.	C	D	T	Package
ULCSA-16	25.45	2.3	2.13	1000
ULCSA-16S	24.5	1.9	1.57	

PCB間隔柱 PCB SPACER

用途：PC板直接壓入固定，另一頭直接壓入機板固定，省時易拆裝。

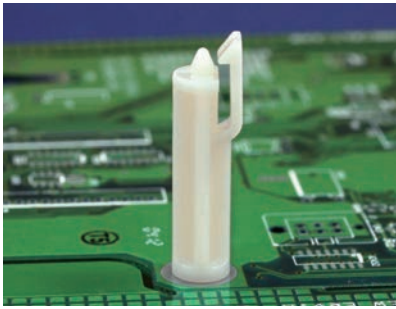

- Material: Nylon 66 (UL)
- Flame Class: 94V-2/94V-0
- Color: Natural/Black
- Unit: mm

MOUNTING HOLE Ø3.3
THICKNESS 1.57

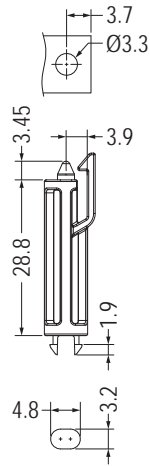

MOUNTING HOLE
THICKNESS 1.57

Part No.	Package
ULCSA-28.8S	500

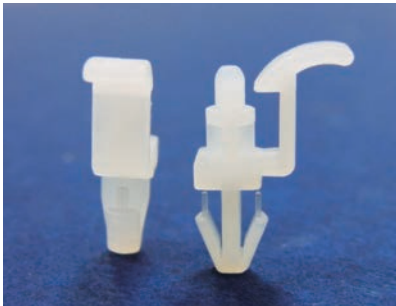

MOUNTING HOLE Ø2.35
THICKNESS 1.0

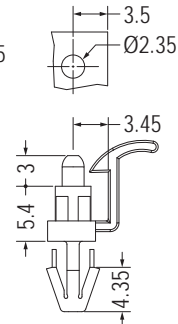
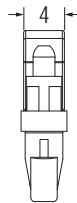

MOUNTING HOLE Ø4.0
THICKNESS 2.4

Part No.	Package
ULCBA-5	1000



MOUNTING HOLE
THICKNESS 1.3

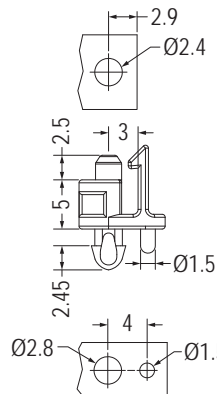

MOUNTING HOLE
THICKNESS 1.7

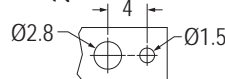

Part No.	Package
ULCSD-5	1000

MOUNTING HOLE
THICKNESS: E

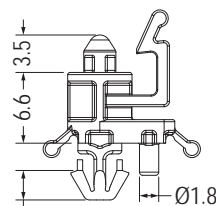
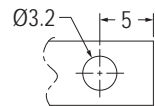
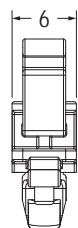

MOUNTING HOLE
THICKNESS: T

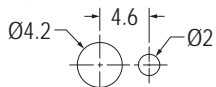

Part No.	E	T	Package
ULCSF-6.6	1.6	1.93	1000
ULCSF-6.6L	1.4~1.8	2.3~2.7	
ULCSF-6.6XL	1.4~1.8	2.52~3.08	
ULCSF-6.6XXL	1.4~1.8	2.83~3.47	

PCB間隔柱 PCB SPACER

用途：PC板直接壓入固定，另一頭直接壓入機板固定，省時易拆裝。

- Material: Nylon 66 (UL)
- Flame Class: 94V-2/94V-0
- Color: Natural/Black/Blue
- Unit: mm

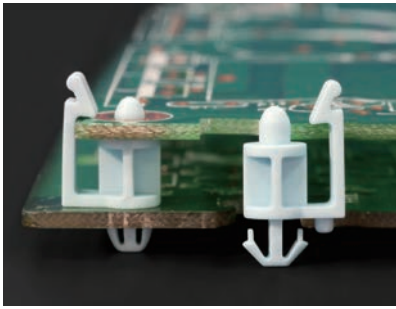

MOUNTING HOLE THICKNESS 1.6

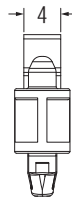

MOUNTING HOLE THICKNESS 2.0

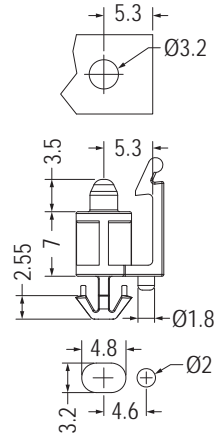

Part No.	Package
ULCSE-7	1000

MOUNTING HOLE THICKNESS 1.6

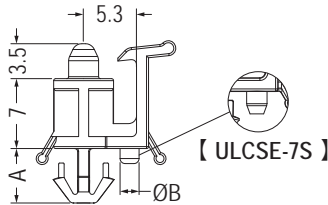
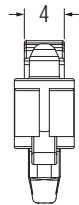
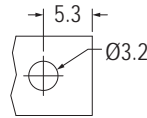

MOUNTING HOLE THICKNESS: T

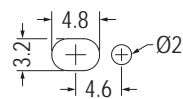

Part No.	A	B	T	Package
ULCSE-7S	4.35	1.8	1.6	1000
ULCSE-7L	5.0	1.9	2.34	
ULCSE-7L1	5.45	1.9	2.4	



MOUNTING HOLE Ø2.6 THICKNESS 0.8-1.0

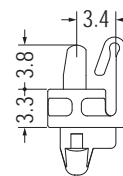
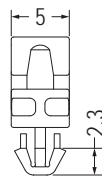
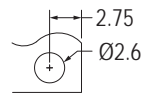

Part No.	Package
LCUE-3.3	2000

MOUNTING HOLE THICKNESS 1.4-1.6

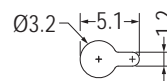

MOUNTING HOLE Ø3.4 THICKNESS 1.2

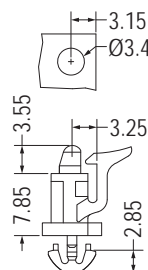
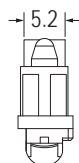

MOUNTING HOLE Ø4.0 THICKNESS 0.8-1.6

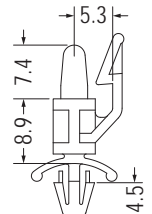
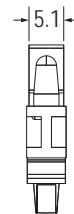
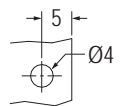

MOUNTING HOLE THICKNESS 1.6

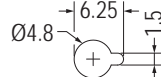

MOUNTING HOLE Ø4.0 THICKNESS 0.8-2.0

Part No.	Package
ULCBA-7.8	1000

Part No.	Package
ULCE-9	1000

PCB間隔柱 PCB SPACER

用途：用於不能鑽孔之機板與PC板間之固定。

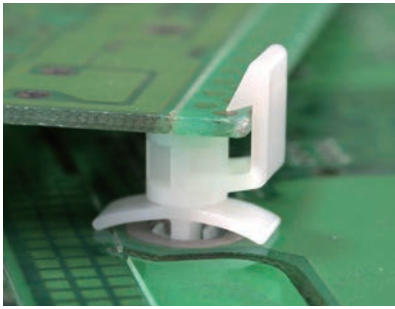

- Material: Nylon 66 (UL)
- Flame Class: 94V-2/94V-0
- Color: Natural/Black
- Unit: mm

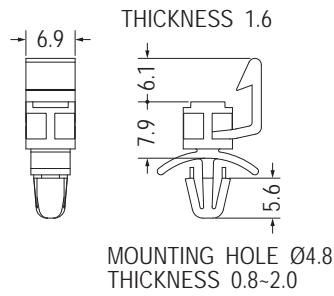

Part No.	Package
ULCBB-7.9	1000

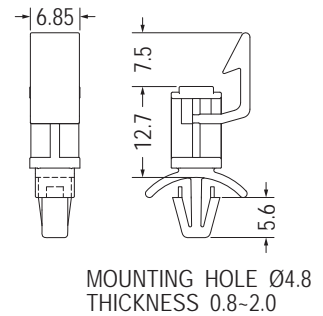

Part No.	Package
ULCBB-12.7L	1000



- Material: Nylon 66 (UL)
- Flame Class: 94V-2/94V-0
- Color: Natural/Black/Blue
- Unit: mm

用途：支撐PC板，使中間不致震動，載重而凹陷短路。

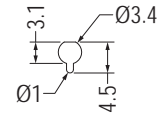
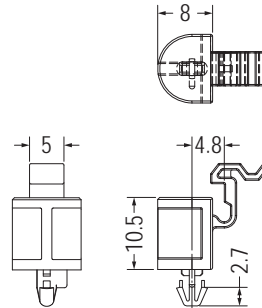

Part No.	Package
LCUA-11	1000



- Material: Nylon 66 (UL)
- Flame Class: 94V-2/94V-0
- Color: Natural/Black/Green
- Unit: mm

用途：PC板直接壓入固定，另一頭直接壓入機板固定，省時易拆裝。

MOUNTING HOLE Ø3.2
THICKNESS 1.6

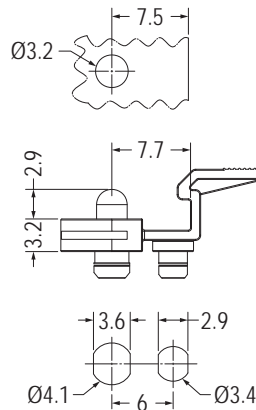
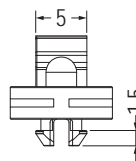

Part No.	Package
LCUAD-1	1000

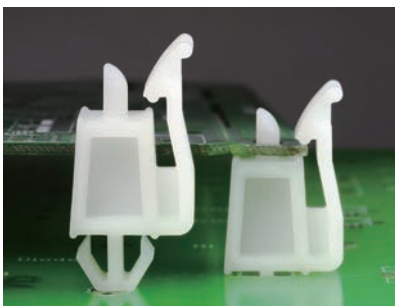

- Material: Nylon 66 (UL)
- Flame Class: 94V-2/94V-0
- Color: Natural/Black
- Unit: mm

MOUNTING HOLE Ø4.0
THICKNESS 1.6

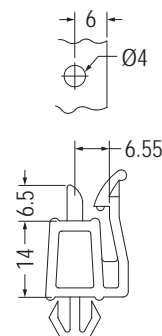
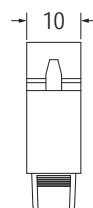

Part No.	Package
KES-15	500

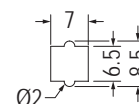

PCB間隔柱 PCB SPACER

用途：PC板直接壓入固定，另一頭直接壓入機板固定，省時易拆裝。

- Material: Nylon 66 (UL)
- Flame Class: 94V-2/94V-0
- Color: Natural/Black
- Unit: mm

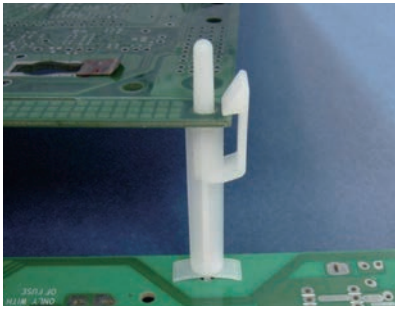

MOUNTING HOLE Ø4.0
THICKNESS 1.6

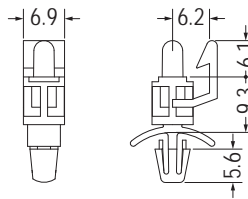

MOUNTING HOLE Ø4.8
THICKNESS 1.6-2.2

Part No.	Package
ULCB-9S	500

MOUNTING HOLE Ø4.0
THICKNESS 1.6

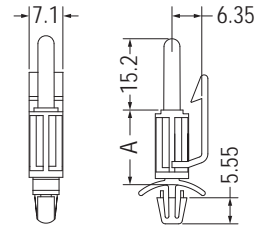

MOUNTING HOLE Ø4.8
THICKNESS 1.6

Part No.	A	Package
ULCB-15	15.9	500
ULCB-38	38.1	

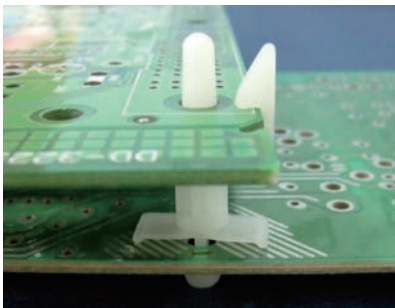

MOUNTING HOLE Ø4.0
THICKNESS 1.6~1.8

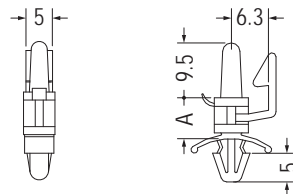

MOUNTING HOLE Ø4.8
THICKNESS 0.5-2.0

Part No.	A	Package
ULCB-6	6.3	1000
ULCB-8	8.0	
ULCB-9	9.5	
ULCB-10	10.0	
ULCB-12	12.7	
ULCB-16	15.9	
ULCB-19.1	19.1	
ULCB-23	23.0	

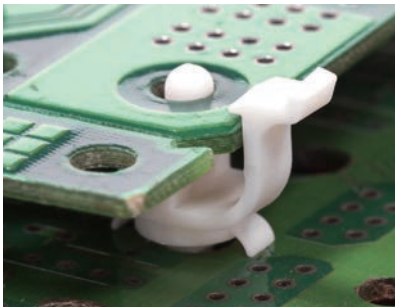

THICKNESS 1.6

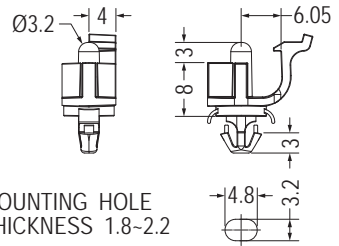

MOUNTING HOLE
THICKNESS 1.8-2.2

Part No.	Package
LCUAC-2L	1000

THICKNESS 1.6

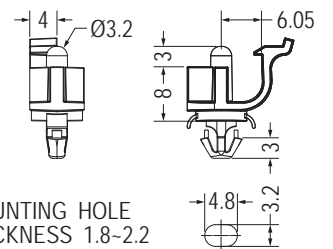

MOUNTING HOLE
THICKNESS 1.8-2.2

- Color: Natural/Black/Green/Gary

Part No.	Package
LCUAC-2R	1000

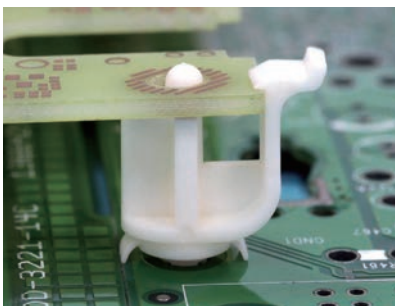

THICKNESS 1.6

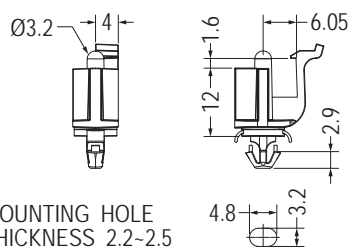

MOUNTING HOLE
THICKNESS 2.2-2.5

Part No.	Package
LCUAC-3L	1000

THICKNESS 1.6

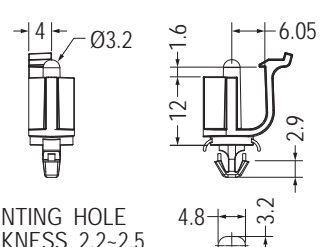

MOUNTING HOLE
THICKNESS 2.2-2.5

Part No.	Package
LCUAC-3R	1000

PCB間隔柱 PCB SPACER

用途：PC板直接壓入固定，另一頭直接壓入機板固定，省時易拆裝。

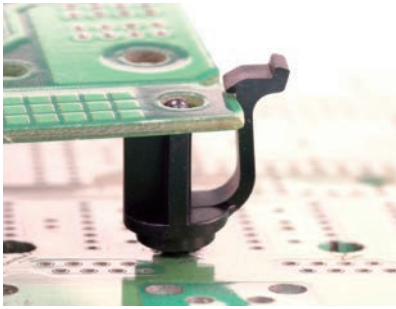

- Material: Nylon 66 (UL)
- Flame Class: 94V-2/94V-0
- Color: Natural/Black
- Unit: mm

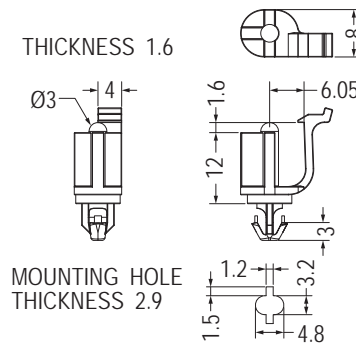

Part No.	Package
LCUAC-7L	1000

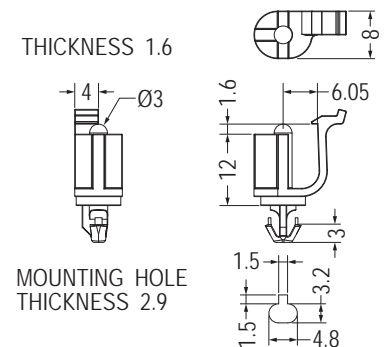

Part No.	Package
LCUAC-7R	1000

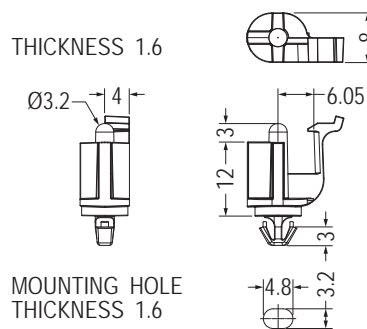
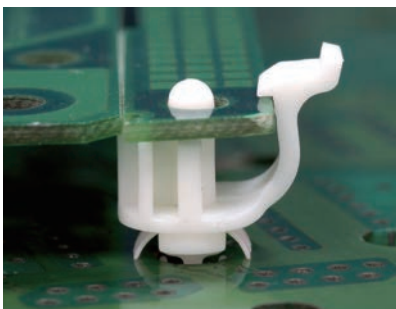

Part No.	Package
LCUAC-8L	1000

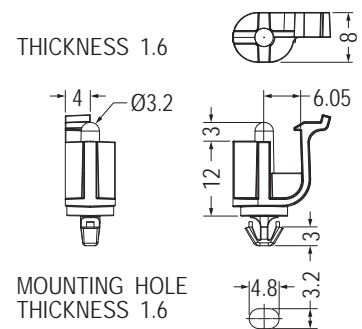

Part No.	Package
LCUAC-8R	1000

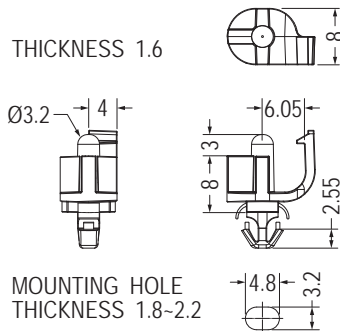

Part No.	Package
LCUAC-9L	1000

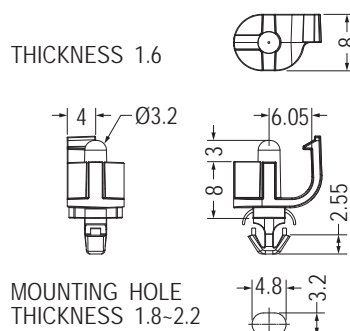

Part No.	Package
LCUAC-9R	1000

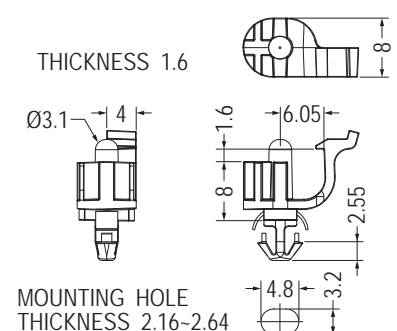

Part No.	Package
LCUAC-11L	1000

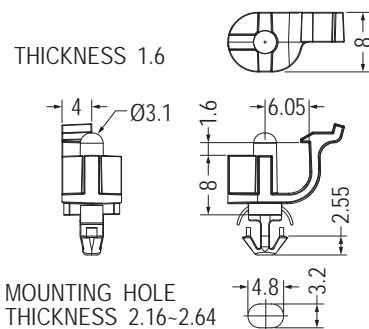

Part No.	Package
LCUAC-11R	1000

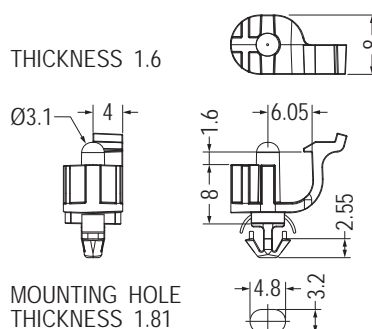

Part No.	Package
LCUAE-8L	1000

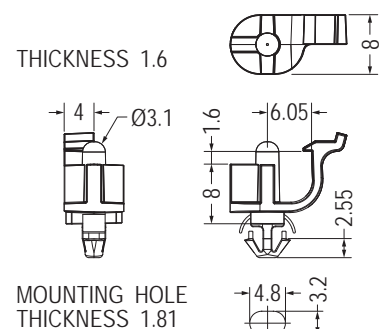

Part No.	Package
LCUAE-8R	1000

PCB間隔柱 PCB SPACER

用途：PC板直接壓入固定，另一頭直接壓入機板固定，省時易拆裝。

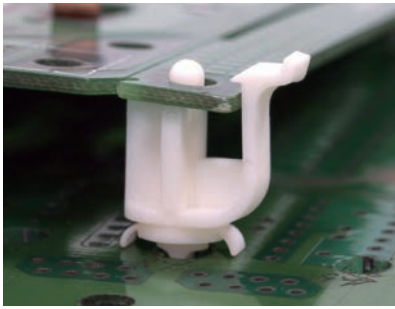

- Material: Nylon 66 (UL)
- Flame Class: 94V-2/94V-0
- Color: Natural/Black
- Unit: mm

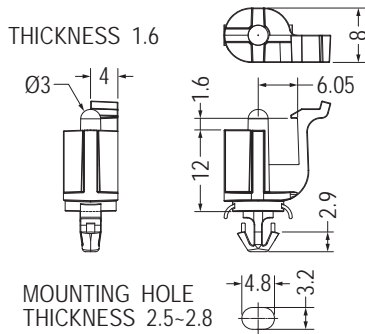

Part No.	Package
LCUAE-12L	1000

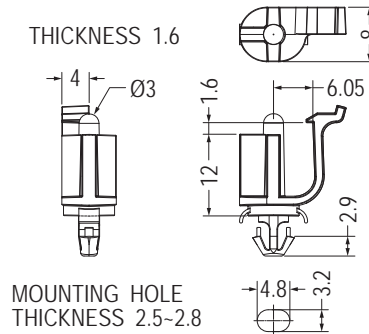

Part No.	Package
LCUAE-12R	1000

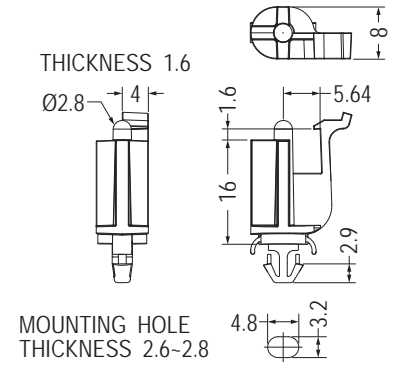

Part No.	Package
LCUAE-16LA	1000

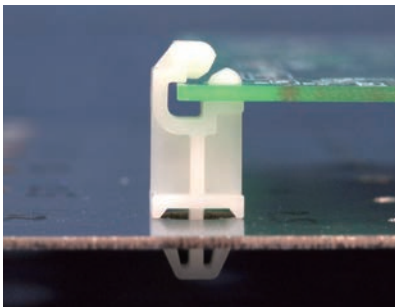

- Material: Nylon 66 (UL)
- Flame Class: 94V-2/94V-0
- Color: Natural/Black
- Unit: mm

用途：用於PC板固定及墊高，拆卸方便。

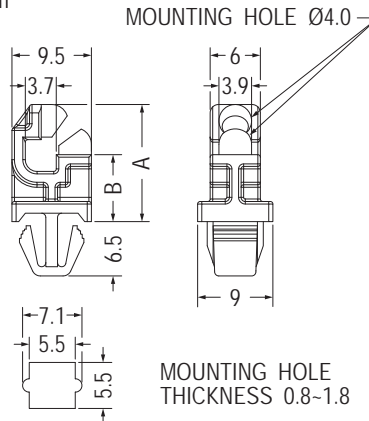

Part No.	A	B	Package
LCMM-8	14.0	8.0	1000
LCMM-12	18.0	12.0	
LCMM-18	24.0	18.0	

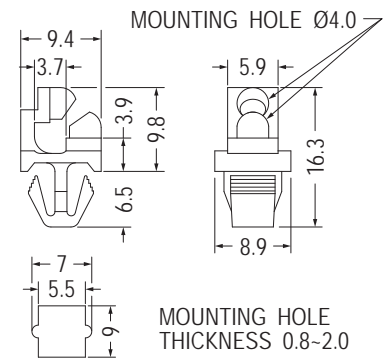

Part No.	Package
LCMM-4	1000



- Material: Nylon 66 (UL)
- Flame Class: 94V-2/94V-0
- Color: Natural/Black
- Unit: mm

用途：將PC板固定於機殼上，PC板可前後30°移動。

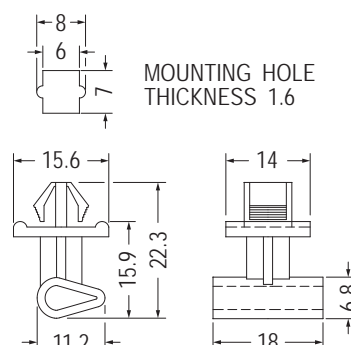

Part No.	Package
PS-16	500

PCB間隔柱 PCB SPACER

用途：用於PC板固定及墊高，拆卸方便。

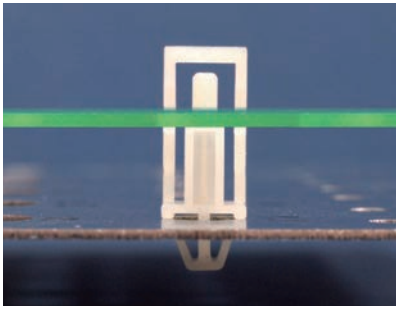

- Material: Nylon 66 (UL)
- Flame Class: 94V-2/94V-0
- Color: Natural/Black
- Unit: mm

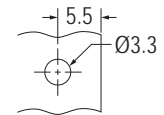
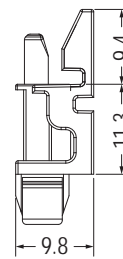
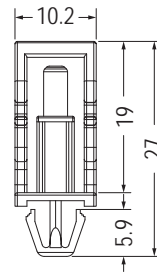

MOUNTING HOLE Ø3.3
THICKNESS 1.6

MOUNTING HOLE
THICKNESS 0.8-1.2

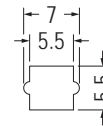

Part No.	Package
KEMS-11.3	500

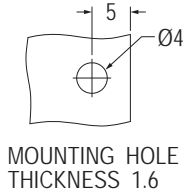
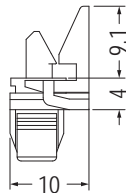
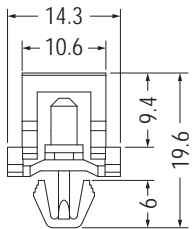
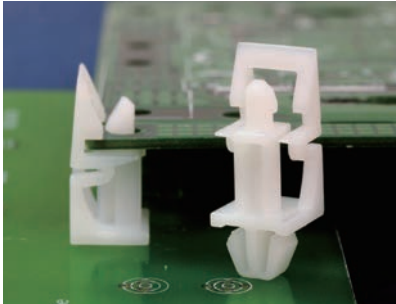

MOUNTING HOLE
THICKNESS 1.6

MOUNTING HOLE
THICKNESS 1.0-1.8

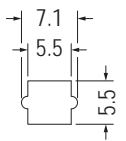

Part No.	Package
KEML-4	500

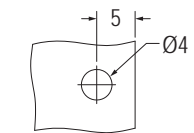
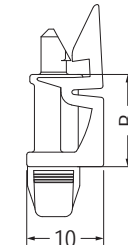
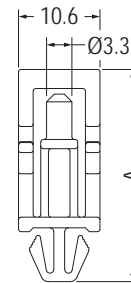

MOUNTING HOLE
THICKNESS 1.6

MOUNTING HOLE
THICKNESS 1.0-1.8

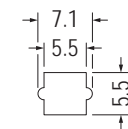

Part No.	A	B	Package
KEML-10	25.6	10.0	500
KEML-12	27.6	12.0	1000

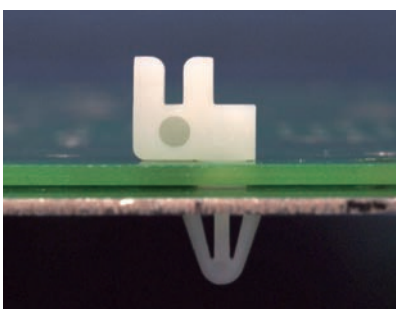

- Material: Nylon 66 (UL)
- Flame Class: 94V-2/94V-0
- Color: Natural/Black
- Unit: mm

用途：用於PC板與機板之固定。

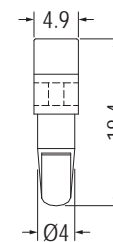
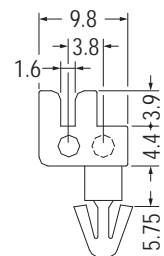

MOUNTING HOLE Ø4.3
THICKNESS 4.0

Part No.	Package
LCU-18	2000

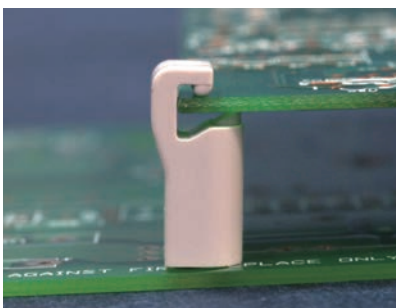

- Material: PC+ABS
- Color: Natural/Gray
- Unit: mm

用途：用於PCB固定及墊高，拆裝方便。

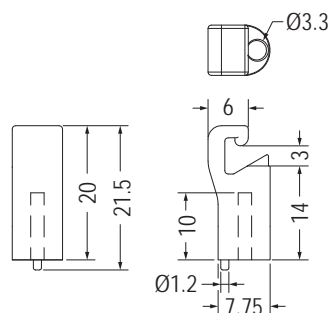

Part No.	Package
KESS-19	500

PCB固定座 PCB MOUNTING BLOCK

用途：用於PC板與機板之固定。



- Material: Nylon 66 (UL)
- Flame Class: 94V-2/94V-0
- Color: Natural/Black
- Unit: mm

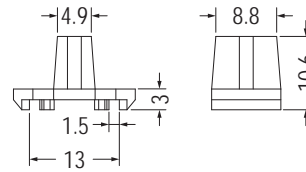
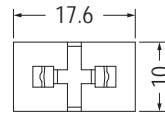

Part No.	Package
LIH-8	2000

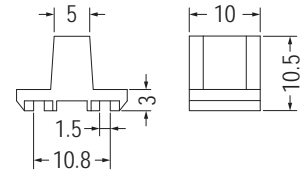
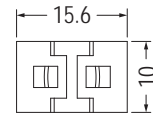

Part No.	Package
MOU-01	2000

間隔柱 SPACER

用途：用於零件之固定。



- Material: PC (UL)
- Flame Class: 94V-2
- Color: Natural/Black
- Unit: mm

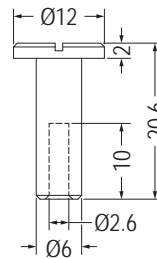

Part No.	Package
SMHC-1	1000

PCB間隔柱 PCB SPACER

用途：用於PC板與機板間墊高，省時方便。

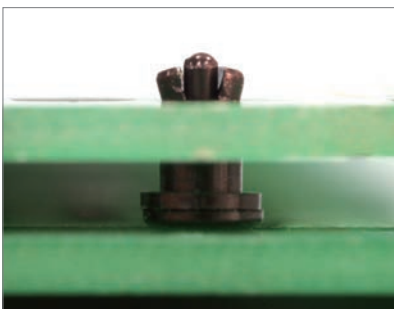

- Material: Nylon 66 (UL)
- Flame Class: 94V-2/94V-0
- Color: Natural/Black
- Unit: mm

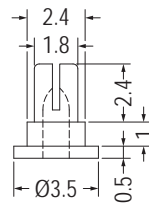

【SRMA-2A】

MOUNTING HOLE Ø1.8
THICKNESS 1.0-1.2

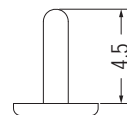

【SRMA-2B】

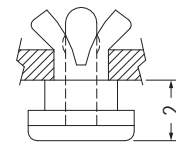

組裝示意圖

Part No.	組裝方式	Package
SRMA-2	不組裝	2000
SRMA-2F	SRMA-2A	
	SRMA-2B 組裝	

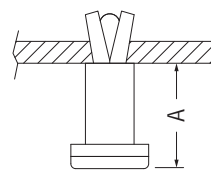
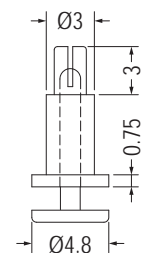
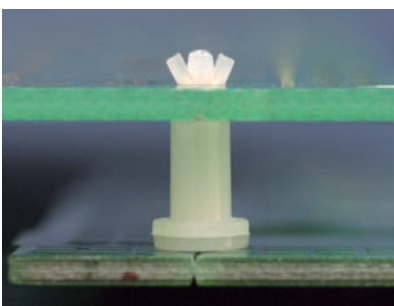

組裝示意圖

MOUNTING HOLE Ø2.0
THICKNESS 0.8-1.6

Part No.	A	Package
SRMA-3	3.0	2000
SRMA-3.5	3.5	
SRMA-4	4.0	
SRMA-5	5.0	
SRMA-6	6.5	
SRMA-9	9.0	

PCB間隔柱 PCB SPACER

用途：用於PC板與機板間之固定易裝卸。

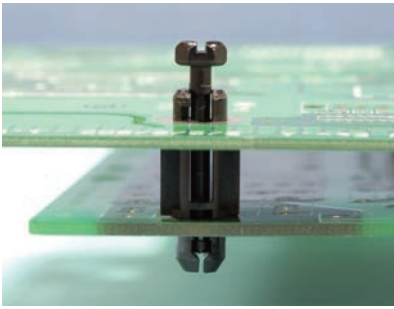

- Clip Material: PC (UL)/94V-2
- Pin Material: Nylon 66 (UL)/94V-2
- Color: Black
- Unit: mm

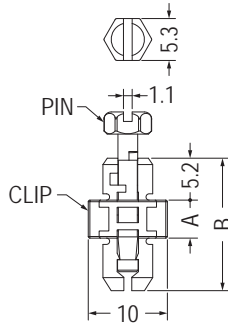

MOUNTING HOLE $\varnothing 6.3\text{-}\varnothing 6.4$
THICKNESS 1.4-2.4

【 SCMB-4.8 】

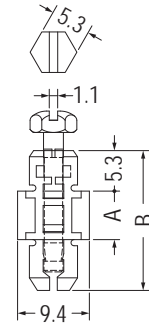

MOUNTING HOLE $\varnothing 6.4\text{-}\varnothing 6.5$
THICKNESS 0.8-1.6

Part No.	A	B	Package
SCMB-4.8	4.8	16.6	1000
SCMB-6.3	6.35	18.3	
SCMB-9.5	9.5	21.45	
SCMB-12.7	12.7	24.65	
SCMB-15.9	15.9	27.85	
SCMB-19.1	19.1	31.05	

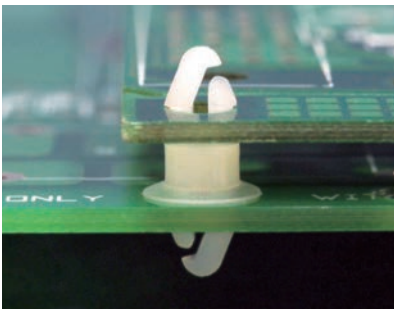

- Material: Nylon 66 (UL)/PC (UL)
- Flame Class: 94V-2/94V-0
- Color: Natural/Black
- Unit: mm

用途：PC板與PC板間之固定，不佔空間。

MOUNTING HOLE $\varnothing 4.0$
THICKNESS 1.6-1.9

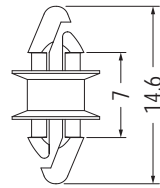

MOUNTING HOLE $\varnothing 4.0$
THICKNESS 1.6-1.9

Part No.	Package
MSPR-3	1000

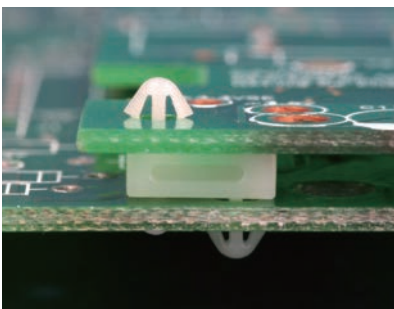

- Material: Nylon 66 (UL)
- Flame Class: 94V-2/94V-0
- Color: Natural/Black
- Unit: mm

用途：兩片PC板間隔之固定。

MOUNTING HOLE $\varnothing 3.2$
THICKNESS 1.6

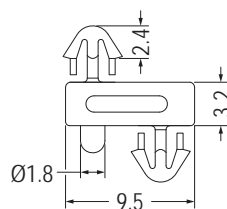

MOUNTING HOLE $\varnothing 3.2$
THICKNESS 1.6

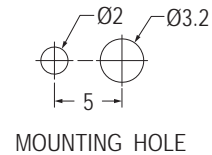
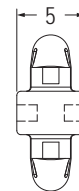

Part No.	Package
LUCE-1	1000

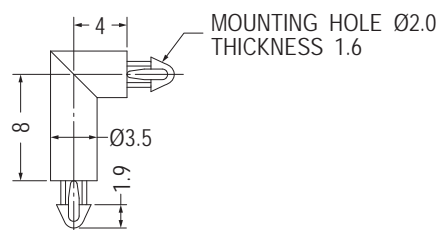
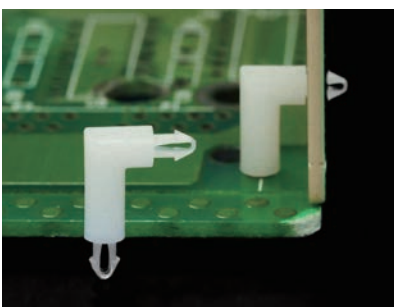

MOUNTING HOLE $\varnothing 2.0$
THICKNESS 1.6

Part No.	Package
EM-682	2000

PCB固定扣 PCB HINGE

用途：一端固定於機板或PC板上，另一端固定於PC板上成90°。

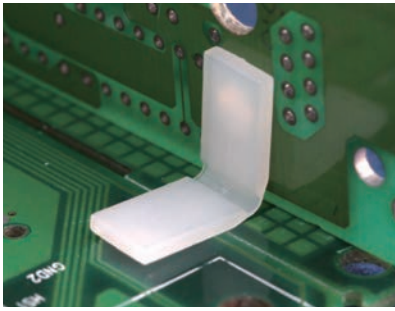

- Material: Nylon 66 (UL)
- Flame Class: 94V-2/94V-0
- Color: Natural/Black
- Unit: mm

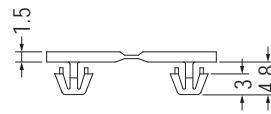

MOUNTING HOLE Ø4.0
THICKNESS 1.6-1.8

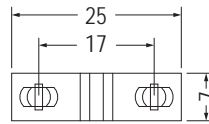

Part No.	Package
LPZ-1	1000

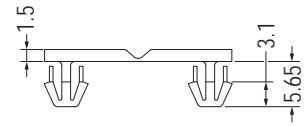

MOUNTING HOLE Ø4.0
THICKNESS 2.36

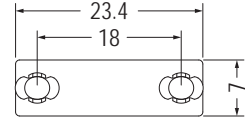

Part No.	Package
LPZ-9	1000

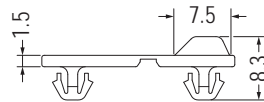
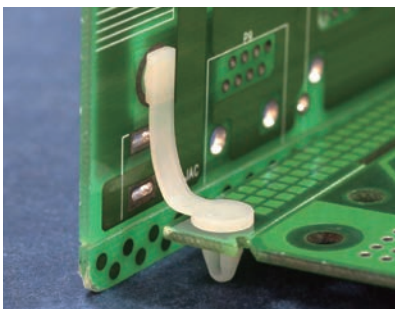

MOUNTING HOLE Ø4.0
THICKNESS 1.6

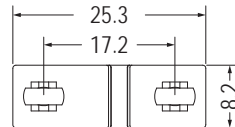

Part No.	Package
LPZ-6	1000

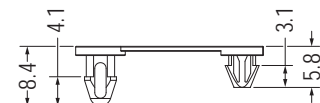

MOUNTING HOLE Ø4.0 THICKNESS 3.0 MOUNTING HOLE Ø3.8 THICKNESS 1.4

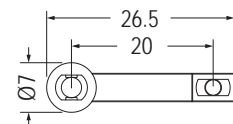

Part No.	Package
LPZ-2	1000

PCB固定扣 PCB BRACKET

用途：快速固定PC板於機板上。

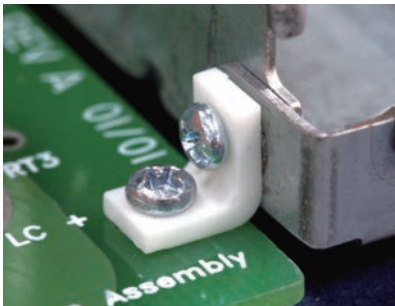

- Material: Nylon 66 (UL)
- Flame Class: 94V-2/94V-0
- Color: Natural/Black
- Unit: mm

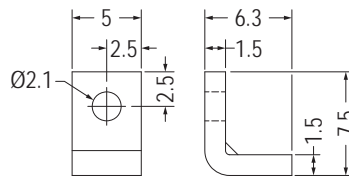
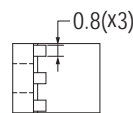

Part No.	Package
DELT-19	1000

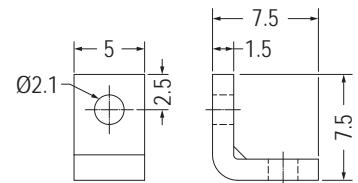
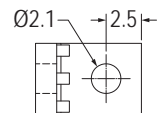

Part No.	Package
DELT-25	1000

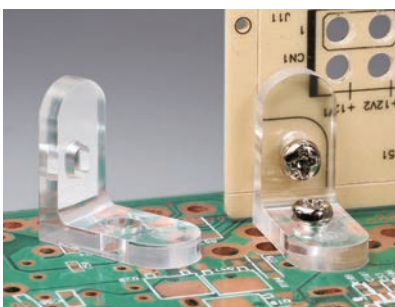

- Material: PC (UL)
- Flame Class: 94V-2
- Color: Transparent
- Unit: mm

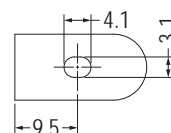
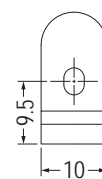
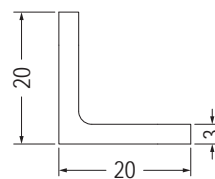

Part No.	Package
LPZA-1	1000

PCB固定座 PCB MOUNTING BLOCK

用途：做為PC板與機板間之固定，需配合M3螺絲使用。



- Material: ABS (UL)
- Flame Class: 94HB
- Color: Natural
- Unit: mm

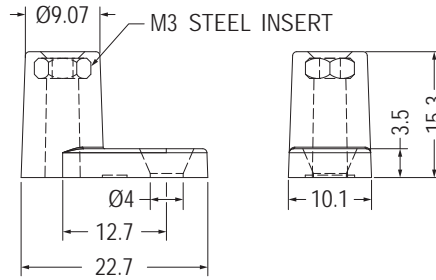

Part No.	Package
LLCB3-15	1000

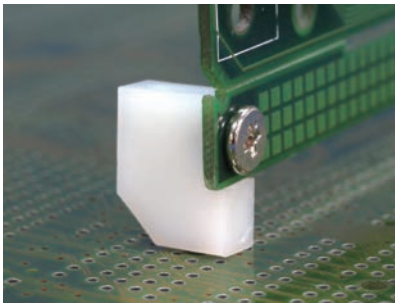

- Material: Nylon 66 (UL)
- Flame Class: 94V-2/94V-0
- Color: Natural/Black
- Unit: mm

用途：用於PC板固定，使PC板與機板成90°固定。

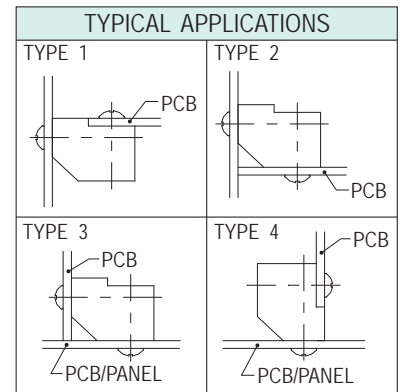
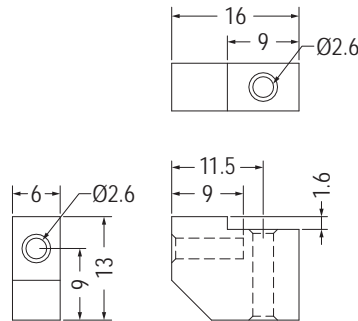

Part No.	Package
PMB-1	500

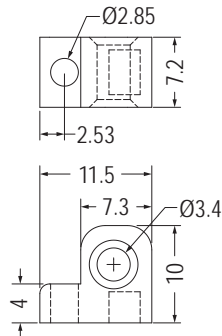
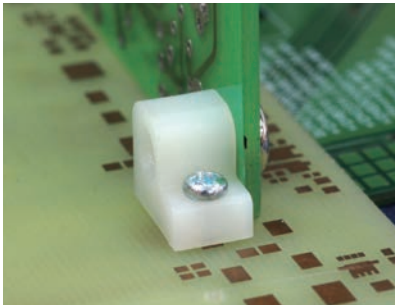

Part No.	Package
PMB-2	500

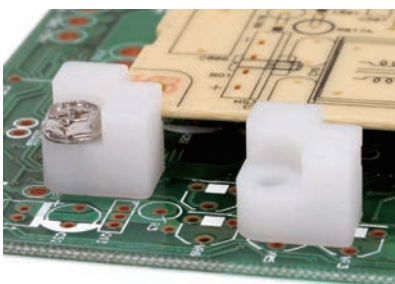

- Material: Nylon 66 (UL)
- Flame Class: 94V-2/94V-0
- Color: Natural/Black
- Unit: mm

用途：快速固定PC板於機板上。

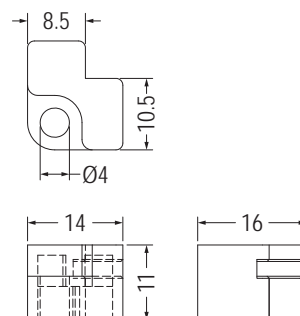

Part No.	Package
TCEA-1	1000

PCB固定座 PCB MOUNTING BLOCK

用途：配合螺絲，固定PC板於機板上。



- Material: PC (UL)
- Flame Class: 94V-2/94V-0
- Color: Transparent
- Unit: mm

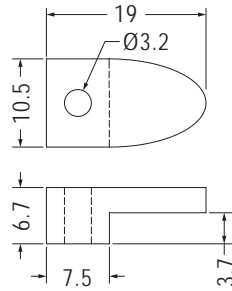

Part No.	Package
HW2839	1000



- Material: Nylon 66 (UL)
- Flame Class: 94V-2/94V-0
- Color: Natural/Black
- Unit: mm

用途：做為PC板與機板之絕緣。

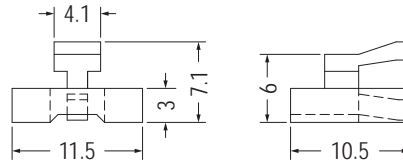

Part No.	Package
JYCE-1	1000

PCB間隔柱 PCB SPACER

用途：用於散熱片之絕緣。

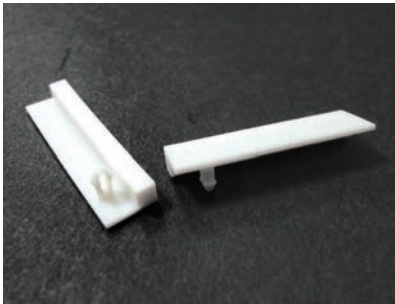

- Material: Nylon 66 (UL)
- Flame Class: 94V-2/94V-0
- Color: Natural/Black
- Unit: mm

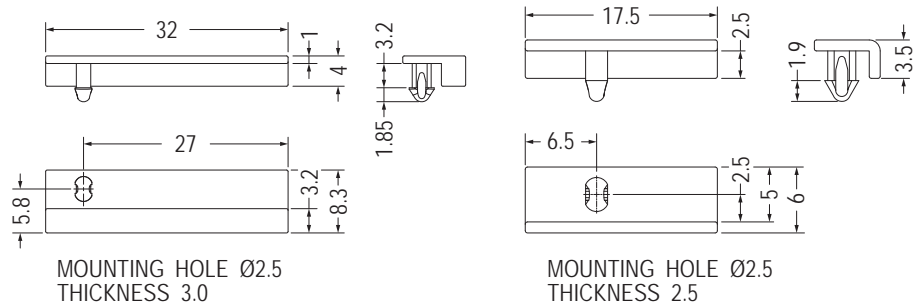

Part No.	Package
CGLF-32	1000

Part No.	Package
CGLE-18	1000



- Material: Nylon 66 (UL)
- Flame Class: 94V-2/94V-0
- Color: Natural/Black
- Unit: mm

用途：用於PC板與機板間之固定。

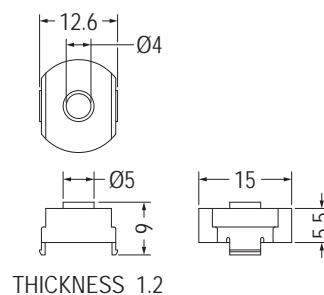

Part No.	Package
DDMC-5.5	1000

圓體間隔柱 ROUND SPACER

用途：用於零件之間隔與固定。



- Material: Nylon 66 (UL)
- Flame Class: 94V-2
- Color: Black
- Unit: mm

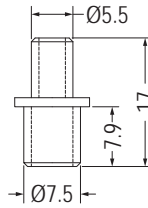
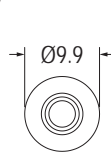

Part No.	Package
BPLT-9	1000

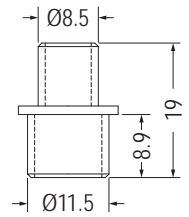
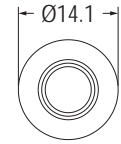

Part No.	Package
BPLT-13	1000



- Material: POM (UL)
- Flame Class: 94HB
- Color: Black
- Unit: mm

用途：用於零件之絕緣使用，RSUA-1A與RSUA-1B需配合使用。

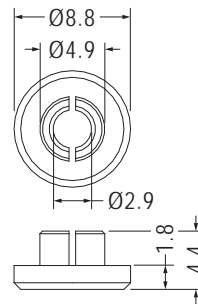

Part No.	Package
RSUA-1A	1000

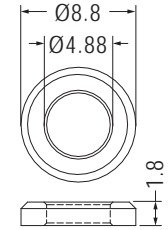

Part No.	Package
RSUA-1B	1000

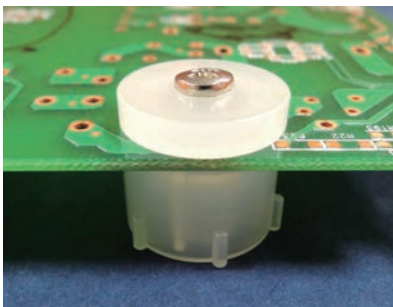

- Material: PC (UL)
- Flame Class: 94V-0
- Color: Natural
- Unit: mm

用途：做為PC板與機板間之墊高與固定。

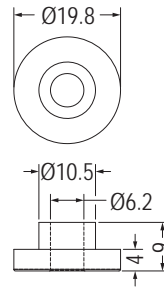

Part No.	Package
RLA-1	500

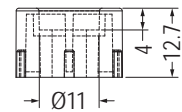
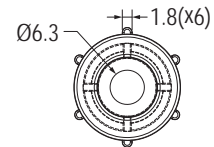

Part No.	Package
RLA-12.7	500

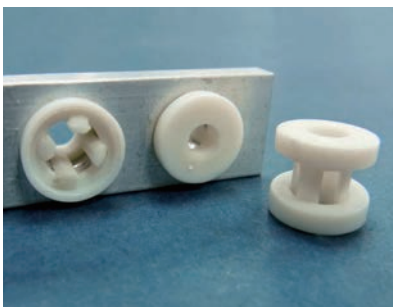

- Material: Nylon 66 (UL)
- Flame Class: 94V-2/94V-0
- Color: Natural/Black
- Unit: mm

用途：用於PC板與機板間之墊高與絕緣。

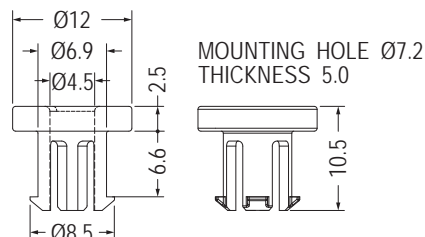

Part No.	Package
RML-1	1000

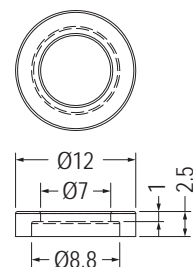

Part No.	Package
RML-25	1000

圓體間隔柱 ROUND SPACER

用途：用於PC板與機板間之固定。

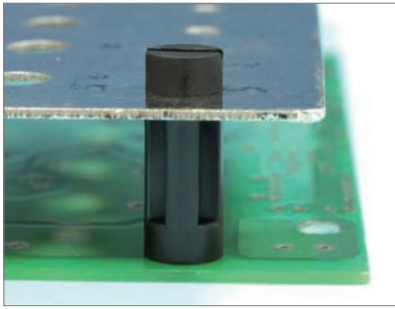

- Material: Nylon 66 (UL)
- Flame Class: 94V-2/94V-0
- Color: Natural/Black
- Unit: mm

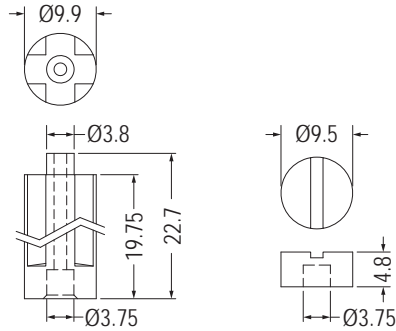

【 JYCE-2A 】

【 JYCE-2B 】

Part No.	Package
JYCE-2	500

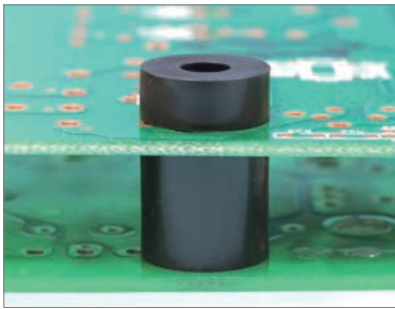

- Material: POM (UL)
- Flame Class: 94HB
- Color: Natural/Black
- Unit: mm

用途：用於PC板與機板間之墊高與絕緣。

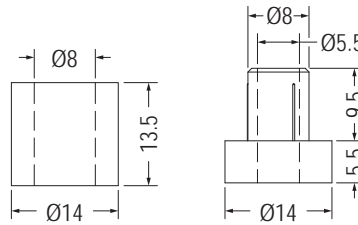

【 RXS-13.5 】

【 RXS-1 】

Part No.	Package
RXS-1	500
RXS-13.5	

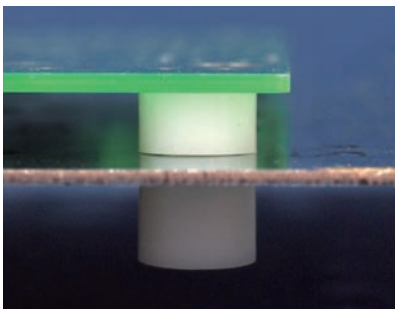

- Material: ABS (UL)
- Flame Class: 94HB
- Color: Natural
- Unit: mm

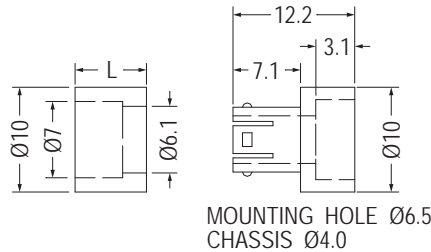

【 RMM- 】

【 RMM-1 】

Part No.	L	Package	
RMM-1	RMM-75	7.5	1000
	RMM-100	10.0	
	RMM-150	15.0	



- Material: Nylon 66 (UL)
- Flame Class: 94V-2/94V-0
- Color: Natural
- Unit: mm

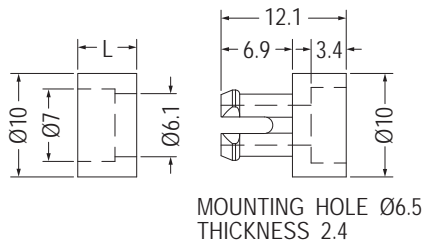

【 RMM- 】

【 RMM-3 】

Part No.	L	Package	
RMM-3	RMM-57	5.7	1000
	RMM-200	20.0	

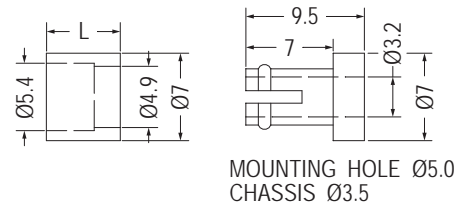

【 RSS- 】

【 RSS-1 】

Part No.	L	Package	
RSS-1	RSS-60	6.0	1000
	RSS-78	7.8	
	RSS-105	10.5	
	RSS-150	15.0	500
	RSS-180	18.0	
	RSS-200	20.0	
RSS-250	25.0		

圓體間隔柱 ROUND SPACER

用途：用於PC板與機板間之墊高與絕緣。

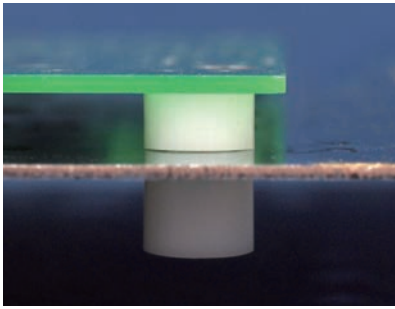

- Material: ABS (UL)
- Flame Class: 94HB
- Color: Natural
- Unit: mm

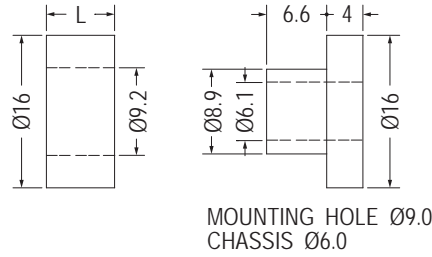

【 RXL- 】

【 RXL-1 】

Part No.	L	Package	
RXL-1	RXL-5	5.0	500
	RXL-7	7.5	
	RXL-10	10.0	

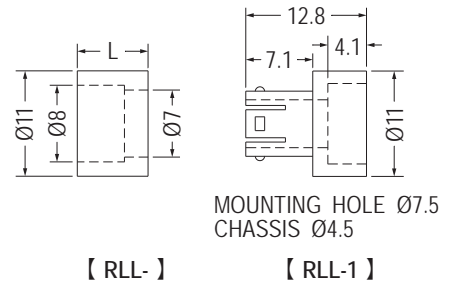

【 RLL- 】

【 RLL-1 】

Part No.	L	Package	
RLL-1	RLL-57	5.7	1000
	RLL-75	7.5	
	RLL-100	10.3	
	RLL-150	15.0	500
	RLL-200	20.0	1000
	RLL-254	25.4	



- Material: PC+ABS (UL)
- Flame Class: 94V-0
- Color: Natural
- Unit: mm

用途：做為PC板與機板之絕緣。

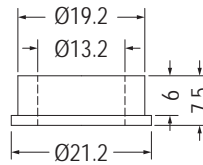

Part No.	Package
RCXL-1	1000

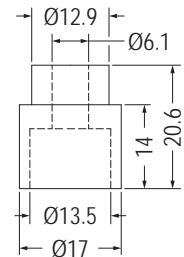

Part No.	Package
RCXL-14	1000

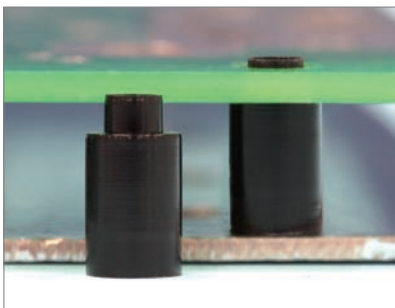

- Material: POM
- Color: Black
- Unit: mm

- Material: ABS (UL)
- Flame Class: 94HB
- Color: Natural/Black
- Unit: mm

- Material: N6T (UL)
- Flame Class: 94V-0
- Color: Black
- Unit: mm

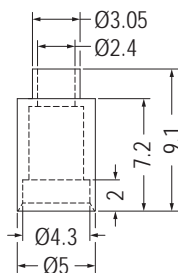

Part No.	Package
LASK-4	1000

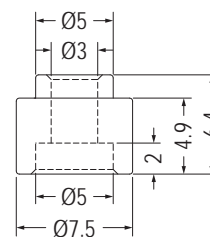

Part No.	Package
LASK-5	1000

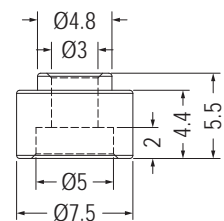

Part No.	Package
LASK-6	1000

圓體間隔柱 ROUND SPACER

用途：做為板件與機板間之墊高與固定。

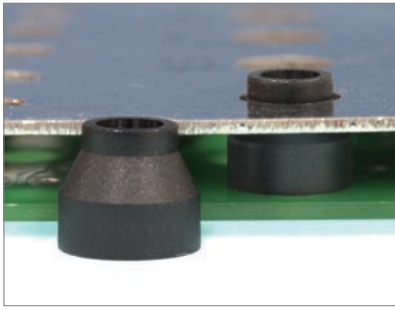

- Material: Nylon 66 (UL)
- Flame Class: 94V-2/94V-0
- Color: Natural/Black
- Unit: mm

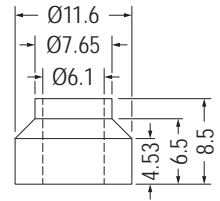
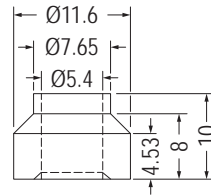

Part No.	Package
RC SL5-10	500

Part No.	Package
RC SL6-8.5	500

1



- Material: Nylon 6T (UL)
- Flame Class: 94V-0
- Color: Black
- Unit: mm

用途：做為螺絲或機板之絕緣用。

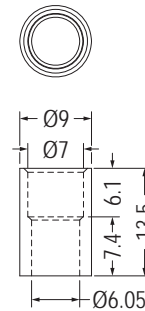

Part No.	Package
R7-13	1000

背膠式圓體間隔柱 ROUND SPACER WITH ADHESIVE TAPE

用途：背膠式，做為PC板之墊高。

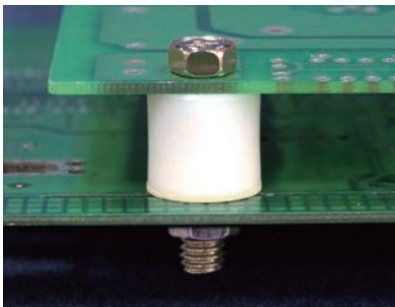

- Material: Nylon 66 (UL)
- Flame Class: 94V-2/94V-0
- Color: Natural/Black
- Unit: mm

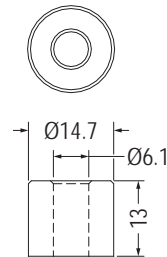

Part No.	Package
6-13A	1000

3M DOUBLE ADHESIVE TAPE

圓體間隔柱 ROUND SPACER

用途：做為PC板與機板之絕緣用。

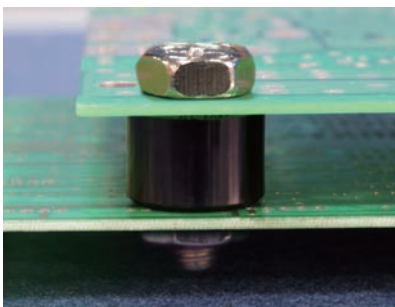

- Material: Nylon 66 (UL)
- Flame Class: 94V-2/94V-0
- Color: Natural/Black
- Unit: mm

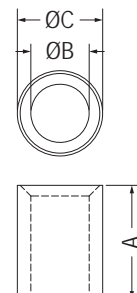
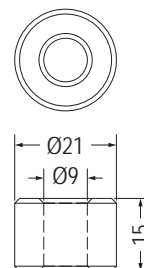

Part No.	Package
9-15	1000

Part No.	A	B	C	Package
KE3.5-2	2.0	3.5	6.3	2000
KE4.1-8	8.0	4.1	6.0	1000

圓體間隔柱 ROUND SPACER

用途：做為PC板與機板之絕緣用。



- Material: Nylon 66 (UL)
- Flame Class: 94V-2
- Color: Red
- Unit: mm

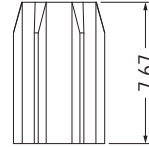
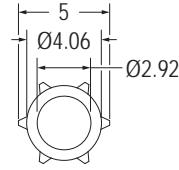

Part No.	Package
EM-733	2000

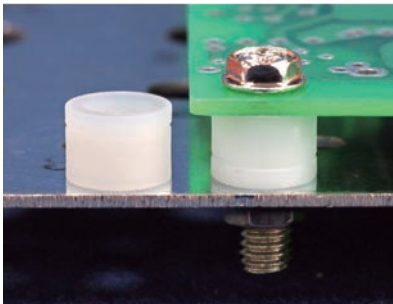

- Material: Nylon 66 (UL)
- Flame Class: 94V-2/94V-0
- Color: Natural/Black
- Unit: mm

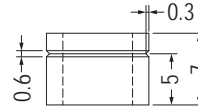
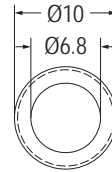

Part No.	Package
RR-1	1000

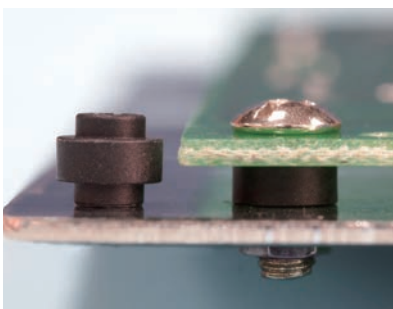

- Material: Nylon 6T (UL)
- Flame Class: 94V-0
- Color: Black
- Unit: mm

MOUNTING HOLE Ø4.5

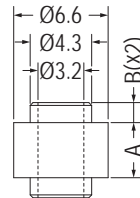

MOUNTING HOLE Ø4.5

Part No.	A	B	Package
LUS-2.7	2.7	1.5	1000
LUS-2.9	2.9	0.7	
LUS-3	3.0	0.7	
LUS-3.85	3.85	1.4	

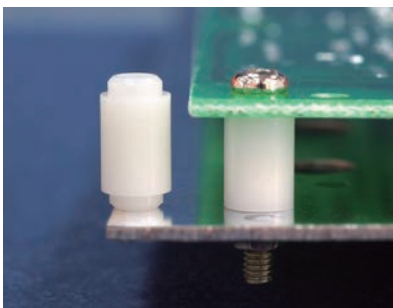

- Material: ABS (UL)
- Flame Class: 94HB
- Color: Natural
- Unit: mm

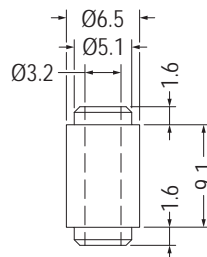

Part No.	Package
LUS-9.1	1000

- Material: Nylon 66 (UL)
- Flame Class: 94V-2/94V-0
- Color: Natural/Black
- Unit: mm

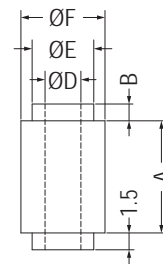

Part No.	A	B	D	E	F	Package
LUS-10	10.0	1.5	3.2	5.5	7.5	1000
LUS-74.5	74.5	1.0	6.5	8.0	10.0	500

圓體間隔柱 ROUND SPACER

用途：用於PC板與機板之絕緣。

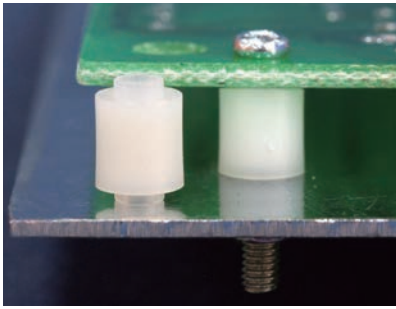

- Material: Nylon 66 (UL)
- Flame Class: 94V-2/94V-0
- Color: Natural/Black
- Unit: mm

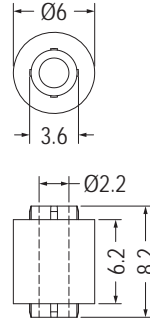

Part No.	Package
LUS2-8.2	1000

MOUNTING HOLE Ø3.5

1

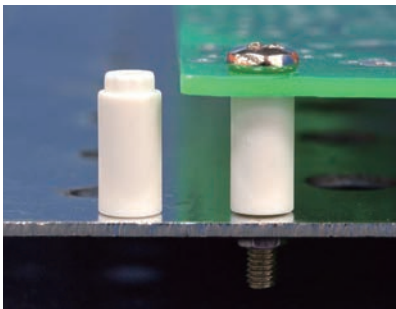

- Material: PBT (UL)
- Flame Class: 94V-0
- Color: Natural/Black
- Unit: mm

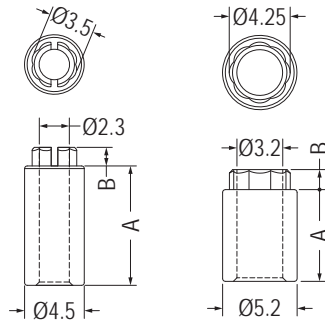

Part No.	A	B	Package
LUSS-6.2	6.2	1.0	1000
LUSS-6.4	6.4	1.4	
LUSS-7.1	7.07	1.4	
LUSS-9	9.0	1.4	
LUSS-9.4	9.43	1.4	
LUSS-10.1	10.06	1.4	

【LUSS-6.2, LUSS-9】

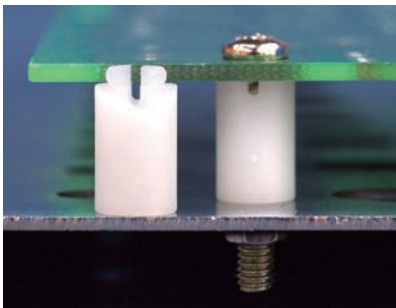

- Material: Nylon 66 (UL)
- Flame Class: 94V-2/94V-0
- Color: Natural/Black
- Unit: mm

用途：PC板與PC板間之固定，不佔空間。

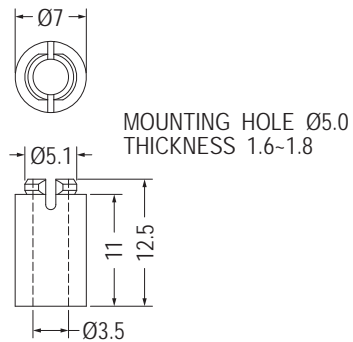

Part No.	Package
LUSA-11	1000

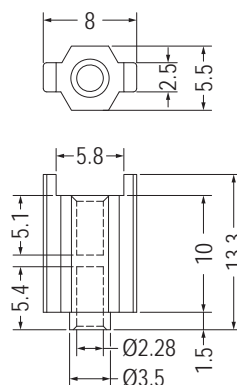
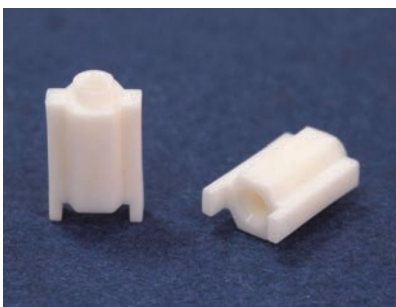

Part No.	Package
LUSB-10	1000

圓體間隔柱 ROUND SPACER

用途：做為PC板之墊高，尺寸齊全。

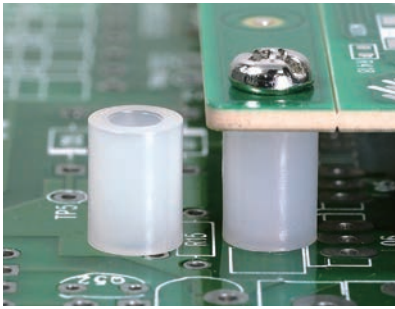

- Material: Nylon 66 (UL)/POM/TPE/PE/PC (UL)/ABS (UL)/PPS
- Flame Class: 94HB/94V-2/94V-0
- Color: Natural/Black
- Unit: mm

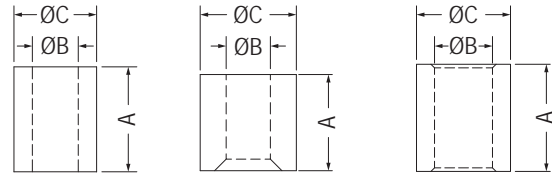

【 2.3-5, 2.3-5.5 】 【 4.9-4.5, 4.9-11.5, 4.9-13 】

Part No.	A(L)	B(ID)	C(OD)	Package	
0.7-1.6	1.6	0.7	2.0	1000	
0.7-3	3.0	0.71	2.2		
1.2-2.5	2.5	1.2	4.0		
1.2-3	3.0	1.2	3.2		
1.2-5	5.0	1.2	4.0		
1.2-6.35	6.35	1.2	3.2	2000	
1.2-7.6	7.6	1.2	4.0	1000	
1.4-3	3.0	1.4	3.5		
1.6-2	2.0	1.6	4.0		
1.6-4	4.0	1.6	4.0		
1.6-5.9	5.89	1.63	3.18		
1.7-11.3	11.3	1.7	3.0	1000	
2-3-1.9	1.9	2.02	3.0	2000	
2.05-3.5	3.5	2.05	3.0	1000	
2.1-2.1	2.1	2.1	2.4		
2.2-2.5	1.5	2.2	2.5	2000	
2.2-5	5.0	2.2	4.0	1000	
2.3-5	5.0	2.3	5.0		
2.3-5.5	5.5	2.3	5.0		
2.4-9.4	9.4	2.4	4.8		
2.5-2.15	2.15	2.5	4.0		
2.5-16.55	16.0	2.5	5.5		
2.7-2.8	2.84	2.7	6.35		
2.7-6.7	6.71	2.7	6.35		
2.73-2.3	2.3	2.73	4.3		
2.8-3.8	3.8	2.8	4.3		
2.95-8	8.0	2.95	3.55		
3-25-6	25.0	3.0	6.0		
3.1-2	2.0	3.1	6.0		2000
3.1-2.2	2.2	3.1	8.0		
★3.1-2.5	2.5	3.1	6.0		
3.1-3.5	3.5	3.1	5.7		
3.1-3.7	3.7	3.15	5.0		
3.1-4.6	4.0	3.1	6.0	1000	
3.1-5	5.0	3.1	6.0		
3.1-6	6.0	3.1	6.0		
6-3.1-7.5	7.5	3.1	6.0	2000	
3.1-7.5	7.5	3.1	8.0	1000	
3.1-8	8.0	3.1	6.0	2000	
3.1-3.8	3.85	3.15	5.0	1000	
3.1-4	4.0	3.15	5.0		
3.2-2.2	2.2	3.2	5.5	2000	
3.2-2.5	2.5	3.2	4.2	1000	
3.2-3	3.0	3.2	5.8		
3.2-4.45	4.45	3.2	6.4		
3-5.8	5.85	3.2	5.0		
3.2-6.4	6.4	3.2	5.8		
6432-6.4	6.4	3.2	6.4		
3.2-6.8	6.8	3.2	4.5		
3.2-10	10.0	3.2	8.0		
3.35-5	5.0	3.35	8.0		
3.5-5.5	5.5	3.5	6.3		

Part No.	A(L)	B(ID)	C(OD)	Package
3.55-10	10.0	3.55	6.0	1000
3.55-31.8	31.8	3.55	6.35	
3.56-4.76	4.76	3.56	7.94	
3.56-9.53	9.53	3.56	6.35	
3.6-2	2.0	3.6	7.0	
3.6-19	19.0	3.6	8.0	2000
3.7-6.1	6.1	3.7	6.4	
3.7-9.5	9.5	3.73	6.35	
3.7-10	10.0	3.73	6.35	1000
3.8-0.5	0.5	3.8	5.3	2000
3.8-5.5	5.5	3.8	5.3	1000
3.9-5.3	5.3	3.9	8.0	
3.95-3.8	3.8	3.95	6.1	2000
4-4.8	4.8	4.0	7.5	2000
4.1-2.5	2.5	4.1	8.0	1000
4.2-2.4	2.4	4.2	7.5	2000
4.2-4.8	4.8	4.2	5.5	
4.2-8.5	8.5	4.2	10.0	1000
4.3-1.5	1.5	4.3	5.8	2000
4.3-5.5	5.5	4.3	5.8	
4.3-10.5	10.5	4.3	5.8	1000
4.3-15.5	15.5	4.3	5.8	
4.4-6	6.0	4.4	7.43	2000
4.4-6.4	6.4	4.4	9.5	
4.5-3.2	3.18	4.45	6.35	1000
★4.5-5	5.0	4.45	6.0	
4.5-2.75	2.75	4.5	6.0	
★4.5-10	10.0	4.5	8.0	
4.5-11	11.0	4.5	7.0	
4.5-11.5	11.5	4.5	7.0	250
4.5-19.9	19.9	4.5	6.1	
4.7-3.5	3.5	4.7	6.0	1000
4.9-3	3.0	4.9	7.94	
4.9-4.5	4.5	4.9	7.94	
4.9-11.5	11.5	4.9	7.94	
4.9-13	13.0	4.9	7.94	
5-3.5	3.5	5.0	9.0	2000
5-4	4.0	5.0	12.0	
5-4.2	4.2	5.0	7.0	
5-6.5L	6.5	5.0	9.5	1000
5-7.9L	7.9	5.0	9.5	
5-38.1	38.1	5.0	7.9	500
5-40	40.0	5.0	9.0	1000
5.1-12.7	12.7	5.1	9.5	
5.2-2	2.0	5.2	6.8	
5.2-2.3	2.3	5.2	6.8	
5.2-3	3.0	5.2	6.8	
5.2-4.1	4.1	5.2	6.8	
5.2-6	6.0	5.2	10.0	
5.2-7.5	7.5	5.2	7.6	
5.2-11	11.0	5.2	7.6	
5.2-13	13.0	5.2	6.8	

圓體間隔柱 ROUND SPACER

用途：做為PC板之墊高，尺寸齊全。

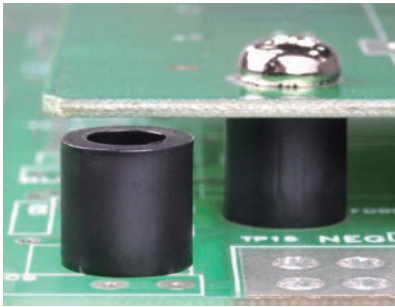

- Material: Nylon 66 (UL)/POM/TPE/PE/PC (UL)/ABS (UL)/PPS
- Flame Class: 94HB/94V-2/94V-0
- Color: Natural/Black
- Unit: mm

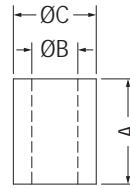

Part No.	A(L)	B(ID)	C(OD)	Package	
5.3-2.8	2.8	5.3	8.5	2000	
5.4-122	122.0	5.4	9.53	250	
5.5-4	4.0	5.5	15.0	1000	
5.55-11.8	11.8	5.55	7.0	1000	
5-5	5.0	5.6	8.6		
5-6	6.0	5.6	8.6		
5-7.9	7.9	5.6	8.6		
5-8	8.0	5.6	8.6		
5-8.8	8.8	5.6	8.6		
5-11.8	11.8	5.6	8.6		
5-14	14.0	5.6	8.6		
5-16.5	16.5	5.6	8.6		
5-16.7	16.7	5.6	8.6		
5-17	17.0	5.6	8.6		
5-20	20.0	5.6	8.6		250
5.7-12.9	12.9	5.7	7.7		1000
5.7-14.1	14.1	5.7	7.7		2000
5.8-4.9	4.9	5.8	7.3		
5.8-14.4	14.4	5.8	7.3		
★6-3.2	3.2	6.0	8.0	250	
6-6	6.0	6.0	10.0		
6-22	22.0	6.0	15.0	1000	
6.2-6S	6.0	6.2	10.0	250	
6.2-10	10.0	6.2	10.4		
6.2-12	12.0	6.2	10.4		
6.3-5	5.0	6.3	15.0	1000	
6.3-20	20.0	6.3	12.7		
6.35-3.2	3.2	6.35	9.1	500	
6.35-7.1	7.1	6.35	8.0		
6.4-3	3.0	6.4	12.0	1000	
6.4-10	10.0	6.4	20.0		
6.5-3	3.0	6.5	9.2	500	

Part No.	A(L)	B(ID)	C(OD)	Package	
6-4.2	4.2	6.6	10.6	1000	
6-4.8	4.8	6.6	9.1		
6-16	15.7	6.6	9.1		
6.8-5	5.0	6.8	10.0		
6.9-12.7	12.7	6.9	12.7		
7-5.5	5.5	7.0	13.0		
7-8.7	8.7	7.0	10.0		
7.5-8.9	8.9	7.5	10.0		
7.5-29	29.0	7.5	11.0		250
★8-1.6	1.6	8.0	15.0		1000
8-16	15.7	8.1	10.7		
8.2-5.5	5.5	8.2	12.0		250
8.2-80	80.0	8.2	10.0		
8.4-5	5.0	8.4	16.0		1000
8.5-4.6	4.6	8.5	10.3		
8.5-612	6.0	8.5	12.0		
8.5-8	7.9	8.5	11.0		
9-2.5	2.5	9.0	15.0		
9-4	4.0	9.0	15.0		
9-10.5	10.5	9.0	15.0		
9.1-7.5	7.5	9.1	17.9		
9.25-4	4.0	9.25	12.25		
9.5-34	34.0	9.5	19.0	250	
10-6	6.0	10.0	12.0	1000	
1012-26	26.0	10.0	12.0		
12-19	19.0	12.0	14.0	250	
12.4-5	5.0	12.4	22.0		
★12.8-20	20.0	12.8	22.0	500	
12.8-35	35.0	12.8	22.0		
13-5	5.0	13.0	24.0	250	
20.5-9.5	9.5	20.5	25.5		
29-16	16.0	29.5	33.5		

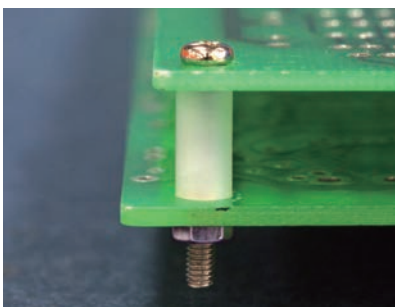

- Material: Nylon 66 (UL)/PBT (UL)
- Flame Class: 94V-2/94V-0
- Color: Natural/Black
- Unit: mm

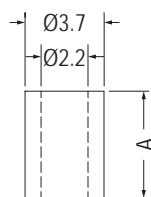

Part No.	A(L)	Package
2-1.8	1.8	2000
2-2	2.0	
2-2.5	2.5	
2-3	3.0	
2-3.2	3.2	
2-4	4.0	
2-4.3	4.3	
2-5	5.0	
2-5.3	5.3	
2-6	6.0	
2-7	7.0	

Part No.	A(L)	Package
2-8	8.0	2000
2-9	9.0	
2-9.5	9.5	
2-10	10.0	
2-11	11.0	
2-12	12.0	
2-13	13.0	
2-14	14.0	
2-15	15.0	
2-16	16.0	

圓體間隔柱 ROUND SPACER

用途：做為PC板之墊高，尺寸齊全。

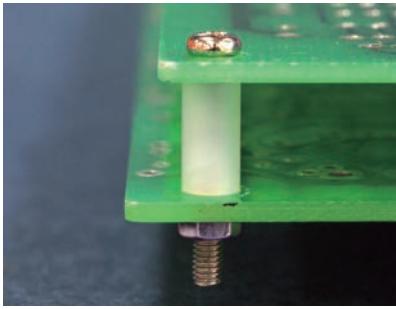

- Material: Nylon 66 (UL)/PBT (UL)
- Flame Class: 94V-2/94V-0
- Color: Natural/Black
- Unit: mm

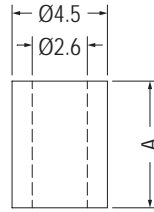

Part No.	A(L)	Package
2.6-2	2.0	2000
2.6-3	3.0	
2.6-4	4.0	
2.6-5	5.0	
2.6-6	6.0	
2.6-7	7.0	
2.6-8	8.0	
2.6-9	9.0	
2.6-10	10.0	
2.6-11	11.0	
2.6-12	12.0	
2.6-13	13.0	
2.6-14	14.0	
2.6-15	15.0	
2.6-16	16.0	

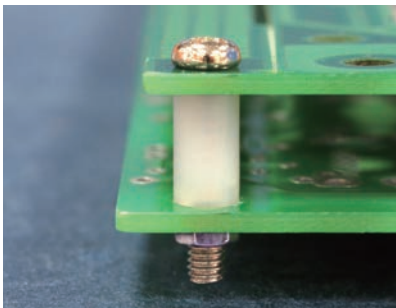

- Material: Nylon 66 (UL)
- Flame Class: 94V-2/94V-0
- Color: Natural/Black
- Unit: mm

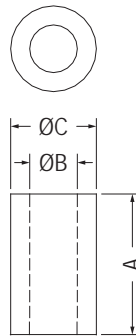

Part No.	A(L)	B(ID)	C(OD)	Package
3-20L	20.0	3.2	6.0	1000
3-38.1	38.1	3.05	6.35	

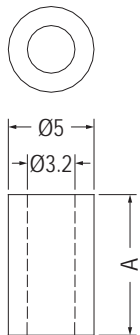

Part No.	A	Package
3-1.5	1.5	2000
3-2	2.0	
3-2.5	2.5	
3-3	3.0	
3-3.3	3.3	
3-3.5	3.5	
3-4	4.0	
3-4.2	4.2	
3-4.5	4.5	
3-5	5.0	
3-5.1	5.05	
3-5.5	5.5	
3-6	6.0	
3-6.35	6.35	
3-7	7.0	

Part No.	A	Package
3-7.5	7.5	2000
3-8	8.0	
3-9	9.0	
3-9.5	9.5	
3-10	10.0	
3-10.5	10.5	
3-11	11.0	
3-12	12.0	
3-13	13.0	1000
3-13.6	13.6	
3-14	14.0	
3-15	15.0	
3-15.5	15.5	
3-16	16.0	
3-16.5	16.5	
3-16.8	16.8	

Part No.	A	Package
3-17	17.0	1000
3-17.5	17.5	
3-18	18.0	
3-19	19.0	
3-20	20.0	
3-21	21.0	
3-22	22.0	
3-23	23.0	
3-24	24.0	
3-25	25.0	
3-26	26.0	
3-27	27.0	
3-28	28.0	
3-29	29.0	
3-30	30.0	
3-35	35.0	

圓體間隔柱 ROUND SPACER

用途：做為PC板之墊高，尺寸齊全。

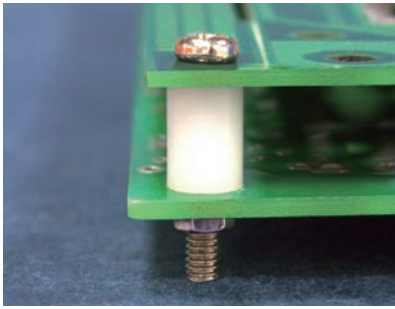

- Material: Nylon 66 (UL)
- Flame Class: 94V-2/94V-0
- Color: Natural/Black
- Unit: mm

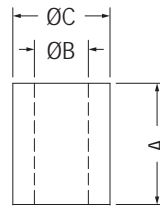
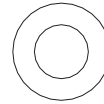

Part No.	A(L)	B(ID)	C(OD)	Package
3.5-1.6	1.6	3.5	6.3	2000
3.5-2	2.0	3.5	6.3	
3.5-3	3.0	3.5	6.3	
3.5-3.5	3.5	3.5	6.3	
3.5-4	4.0	3.5	6.3	
3.5-4.5	4.5	3.5	6.3	
3.5-5	5.0	3.5	6.3	
3.5-6	6.0	3.5	6.3	
3.5-6.4	6.4	3.5	6.3	
3.5-7	7.0	3.5	6.3	
3.5-7.5	7.5	3.5	6.3	
3.5-8	8.0	3.5	6.3	
3.5-9	9.0	3.5	6.3	
3.5-9.5	9.5	3.5	6.3	
3.5-10	10.0	3.5	6.3	
3.5-11	11.0	3.5	6.3	
3.5-12	12.0	3.5	6.3	
3.5-12.7	12.7	3.5	6.3	
3.5-13	13.0	3.5	6.3	
3.5-14	14.0	3.5	6.3	
3.5-15	15.0	3.5	6.3	
3.5-15.5	15.5	3.5	6.3	
3.5-16	16.0	3.5	6.3	
3.5-17	17.0	3.5	6.3	
3.5-17.7	17.7	3.5	6.3	
3.5-18	18.0	3.5	6.3	
3.5-19	19.0	3.5	6.3	
3.5-20	20.0	3.5	6.3	
3.5-21	21.0	3.7	6.3	
3.5-22	22.0	3.7	6.3	
3.5-23	23.0	3.7	6.3	
3.5-24	24.0	3.7	6.3	
3.5-25	25.0	3.7	6.3	
3.5-26	26.0	3.7	6.3	
3.5-27	27.0	3.7	6.3	
3.5-28	28.0	3.7	6.3	
3.5-28.5	28.57	3.55	6.35	
3.5-29	29.0	3.7	6.3	
3.5-30	30.0	3.7	6.3	
3.5-35	35.0	3.7	6.3	

Part No.	A(L)	B(ID)	C(OD)	Package
4-2	2.0	4.2	6.3	2000
4-3	3.0	4.2	6.3	
4-3.4	3.4	4.2	6.3	
4-3.5	3.5	4.2	6.3	
4-4	4.0	4.2	6.3	
4-4.83	4.83	4.2	6.3	
4-5	5.0	4.2	6.3	
4-6	6.0	4.2	6.3	
4-7	7.0	4.2	6.3	
4-7.5	7.5	4.2	6.3	
4-8	8.0	4.2	6.3	
4-8.5	8.5	4.2	6.3	
4-9	9.0	4.2	6.3	
4-9.5	9.5	4.2	6.3	
4-10	10.0	4.2	6.3	
4-11	11.0	4.2	6.3	
4-12	12.0	4.2	6.3	
4-12.7	12.7	4.2	6.3	
4-13	13.0	4.2	6.3	
4-14	14.0	4.2	6.3	
4-15	15.0	4.2	6.3	
4-16	16.0	4.2	6.3	
4-17	17.0	4.2	6.3	
4-18	18.0	4.2	6.3	
4-19	19.0	4.2	6.3	
4-20	20.0	4.2	6.3	
4-21	21.0	4.2	6.3	
4-22	22.0	4.2	6.3	
4-23	23.0	4.2	6.3	
4-24	24.0	4.2	6.3	
4-25	25.0	4.2	6.3	
4-26	26.0	4.2	6.3	
4-27	27.0	4.2	6.3	
4-28	28.0	4.2	6.3	
4-28.7	28.7	4.2	6.3	
4-29	29.0	4.2	6.3	
4-30	30.0	4.2	6.3	
4-40	40.0	4.2	6.3	
4-45	45.0	4.2	6.3	

圓體間隔柱 ROUND SPACER

用途：做為PC板與PC板或機板間之固定不掉落。

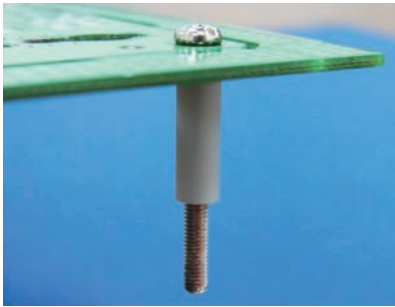

- Material: Nylon 66 (UL)
- Flame Class: 94V-2/94V-0
- Color: Natural/Black
- Unit: mm

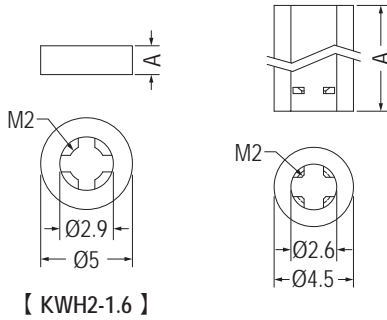

【 KWH2-1.6 】

Part No.	A	Package
KWH2-1.6	1.57	2000
KWH2-2	2.0	
KWH2-3	3.0	
KWH2-3.5	3.5	
KWH2-4	4.0	
KWH2-5	5.0	
KWH2-6	6.0	
KWH2-6.3	6.3	
KWH2-7	7.0	
KWH2-8	8.0	
KWH2-9	9.0	
KWH2-9.5	9.5	
KWH2-10	10.0	
KWH2-11	11.0	
KWH2-11.5	11.5	
KWH2-12	12.0	
KWH2-12.7	12.7	
KWH2-13	13.0	
KWH2-14	14.0	

Part No.	A	Package
KWH2-15	15.0	2000
KWH2-15.9	15.9	
KWH2-16	16.0	
KWH2-17	17.0	
KWH2-18	18.0	
KWH2-19	19.0	
KWH2-20	20.0	1000
KWH2-21	21.0	
KWH2-22	22.0	
KWH2-23	23.0	
KWH2-24	24.0	
KWH2-25	25.0	
KWH2-25.4	25.4	
KWH2-26	26.0	
KWH2-27	27.0	
KWH2-28	28.0	
KWH2-29	29.0	
KWH2-30	30.0	

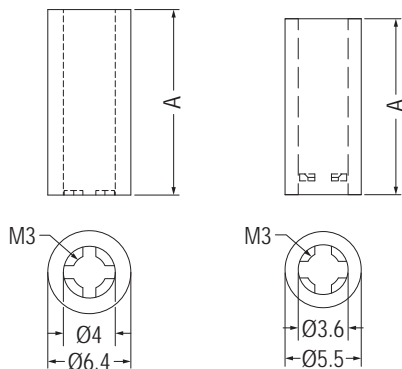

【 KWH3-3.2L, KWH3-14.3L 】

Part No.	A	Package
KWH3-1.5	1.5	2000
KWH3-2	2.0	
KWH3-3	3.0	
KWH3-3.2L	3.2	
KWH3-3.5	3.5	
KWH3-4	4.0	
KWH3-5	5.0	
KWH3-6	6.0	
KWH3-6.3	6.3	
KWH3-7	7.0	
KWH3-8	8.0	
KWH3-9	9.0	
KWH3-9.5	9.5	
KWH3-10	10.0	
KWH3-11	11.0	
KWH3-11.5	11.5	
KWH3-12	12.0	
KWH3-12.7	12.7	
KWH3-13	13.0	

Part No.	A	Package
KWH3-14	14.0	1000
KWH3-14.3L	14.3	
KWH3-15	15.0	
KWH3-15.9	15.9	
KWH3-16	16.0	
KWH3-17	17.0	
KWH3-18	18.0	
KWH3-19	19.0	
KWH3-20	20.0	
KWH3-21	21.0	
KWH3-22	22.0	
KWH3-23	23.0	
KWH3-24	24.0	
KWH3-25	25.0	
KWH3-25.4	25.4	
KWH3-26	26.0	
KWH3-27	27.0	
KWH3-28	28.0	
KWH3-29	29.0	
KWH3-30	30.0	

圓體間隔柱 ROUND SPACER

用途：做為PC板與PC板或機板間之固定不掉落。

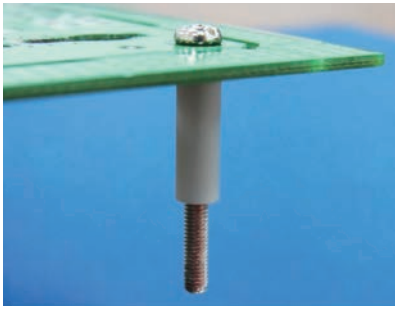

- Material: Nylon 66 (UL)
- Flame Class: 94V-2/94V-0
- Color: Natural/Black
- Unit: mm

1

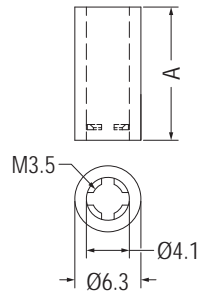

Part No.	A	Package
KWH3.5-2	2.0	2000
KWH3.5-3	3.0	
KWH3.5-4	4.0	
KWH3.5-5	5.0	
KWH3.5-6	6.0	
KWH3.5-6.3	6.3	
KWH3.5-7	7.0	
KWH3.5-8	8.0	
KWH3.5-9	9.0	
KWH3.5-10	10.0	
KWH3.5-11	11.0	
KWH3.5-12	12.0	
KWH3.5-12.7	12.7	
KWH3.5-13	13.0	
KWH3.5-14	14.0	
KWH3.5-15	15.0	
KWH3.5-15.9	15.9	

Part No.	A	Package
KWH3.5-16	16.0	2000
KWH3.5-17	17.0	
KWH3.5-18	18.0	
KWH3.5-19	19.0	
KWH3.5-20	20.0	
KWH3.5-21	21.0	1000
KWH3.5-22	22.0	
KWH3.5-23	23.0	
KWH3.5-24	24.0	
KWH3.5-25	25.0	
KWH3.5-25.4	25.4	
KWH3.5-26	26.0	
KWH3.5-27	27.0	
KWH3.5-28	28.0	
KWH3.5-29	29.0	
KWH3.5-30	30.0	

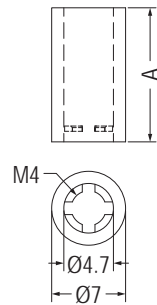
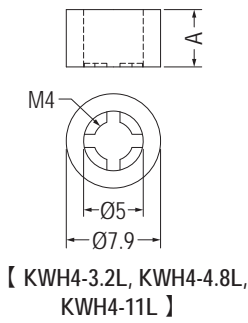

Part No.	A	Package
KWH4-2	2.0	2000
KWH4-3	3.0	
KWH4-3.2L	3.2	
KWH4-4	4.0	
KWH4-4.8L	4.8	
KWH4-5	5.0	
KWH4-6	6.0	
KWH4-6.3	6.3	
KWH4-7	7.0	
KWH4-8	8.0	
KWH4-9	9.0	
KWH4-9.5L	9.5	
KWH4-10	10.0	
KWH4-11	11.0	
★KWH4-11L	11.1	
KWH4-12	12.0	
KWH4-12.7	12.7	
KWH4-13	13.0	
KWH4-14	14.0	

Part No.	A	Package
KWH4-15	15.0	2000
KWH4-15.9	15.9	
KWH4-16	16.0	
KWH4-17	17.0	
KWH4-18	18.0	
KWH4-19	19.0	1000
KWH4-20	20.0	
KWH4-21	21.0	
KWH4-22	22.0	
KWH4-23	23.0	
KWH4-24	24.0	
KWH4-25	25.0	
KWH4-25.4	25.4	
KWH4-26	26.0	
KWH4-27	27.0	
KWH4-28	28.0	
KWH4-29	29.0	
KWH4-30	30.0	

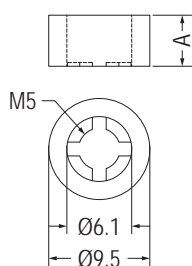
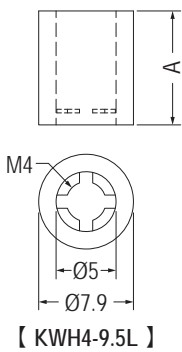

Part No.	A	Package
KWH5-3.2	3.2	2000
KWH5-4.8	4.8	
KWH5-6.4	6.4	
KWH5-7.9	7.9	1000
KWH5-9.5	9.5	

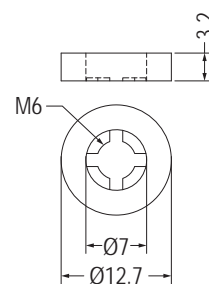

Part No.	Package
KWH6-3.2	1000

圓體間隔柱 ROUND SPACER



- Material: Nylon 66 (UL)
- Flame Class: 94V-2/94V-0
- Color: Natural/Black
- Unit: mm

用途：做為PC板與PC板或機板間之固定不掉落。

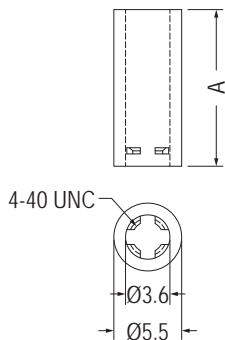

Part No.	A	Package
KWH440-2	2.0	2000
KWH440-3	3.0	
KWH440-4	4.0	
KWH440-5	5.0	
KWH440-6	6.0	
KWH440-6.3	6.3	
KWH440-7	7.0	
KWH440-8	8.0	
KWH440-9	9.0	
KWH440-9.5	9.5	
KWH440-10	10.0	
KWH440-11	11.0	
KWH440-12	12.0	
KWH440-12.7	12.7	
KWH440-13	13.0	
KWH440-14	14.0	
KWH440-15	15.0	

Part No.	A	Package
KWH440-15.9	15.9	2000
KWH440-16	16.0	
KWH440-17	17.0	
KWH440-18	18.0	
KWH440-19	19.0	
KWH440-20	20.0	1000
KWH440-21	21.0	
KWH440-22	22.0	
KWH440-23	23.0	
KWH440-24	24.0	
KWH440-25	25.0	
KWH440-25.4	25.4	
KWH440-26	26.0	
KWH440-27	27.0	
KWH440-28	28.0	
KWH440-29	29.0	
KWH440-30	30.0	

塑膠螺柱 PLASTIC STANDOFF

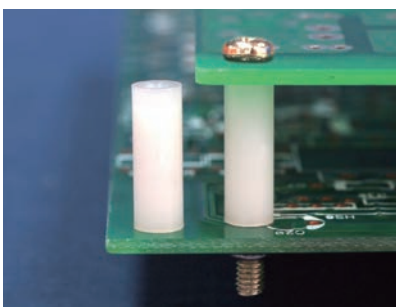

- Material: Nylon 66 (UL)
- Flame Class: 94V-2/94V-0
- Color: Natural/Black
- Unit: mm

用途：做為PC板與機板間之固定。

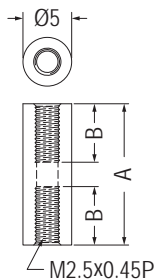

Part No.	A	B	Package
HPP25-14.5	14.5	6.0	1000
HPP25-20	20.0	9.0	

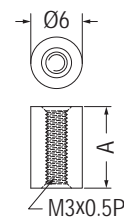

Part No.	A	Package
HPP3-9	9.0	1000
HPP3-9.5	9.5	

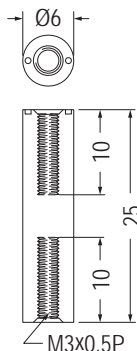
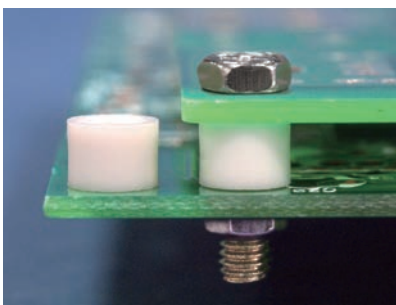

Part No.	Package
HPP3-25	1000

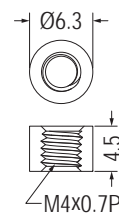

Part No.	Package
HPP4-4.5	1000

塑膠螺柱 PLASTIC STANDOFF

用途：做為牙管的延伸與對接。



- Material: PC+ABS (UL)
- Flame Class: 94V-0
- Color: Black
- Unit: mm

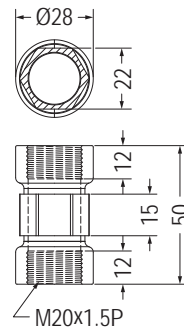

Part No.	Package
HP2050	1000

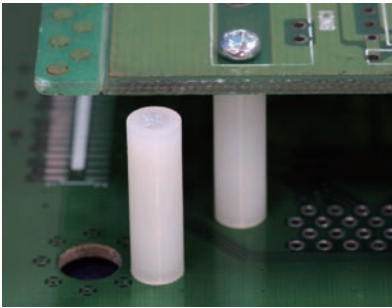

- Material: Nylon 66 (UL)
- Flame Class: 94V-2/94V-0
- Color: Natural/Black
- Unit: mm

用途：做為PC板與機板間之固定。

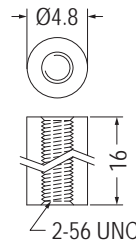

Part No.	Package
HP256-16	1000

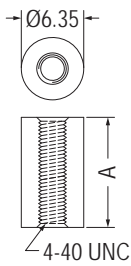

Part No.	A	Package
HPP440-6.35	6.35	1000
HPP440-11.2	11.2	

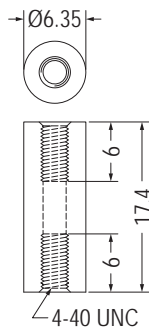

Part No.	Package
HPP440-17.4	1000

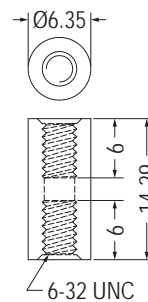

Part No.	Package
HPP632-14	1000

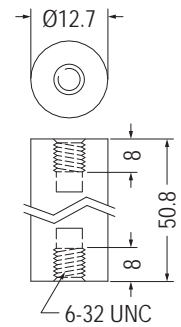

Part No.	Package
HPP632-51	200

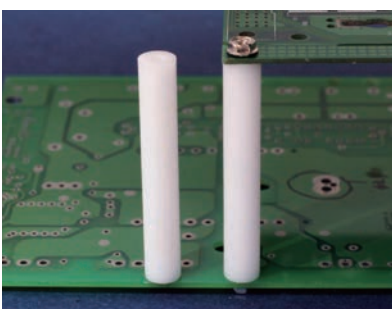

- Material: POM (UL)
- Flame Class: 94HB
- Color: Natural
- Unit: mm

用途：做為PC板與機板間之固定，六角型不滑動。

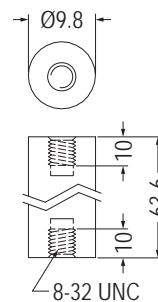

Part No.	Package
HPP10-64	250

金屬柱 METAL STANDOFF

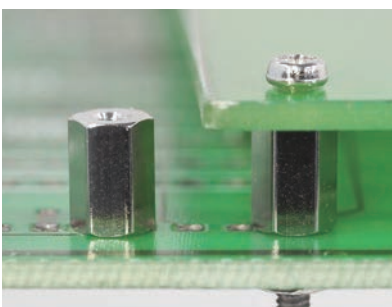

- Material: Brass
- Finish: Nickel Plated
- Unit: mm

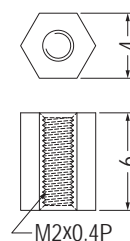

Part No.	Package
BHP2-6	1000

塑膠螺柱 PLASTIC STANDOFF

用途：做為PC板與機板間之固定，六角型不滑動。

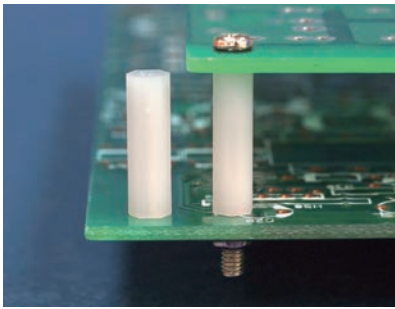

- Material: Nylon 66 (UL)
- Flame Class: 94V-2/94V-0
- Color: Natural/Black
- Unit: mm

Part No.	A	Package
HPS2-4	4.0	1000
HPS2-4.5	4.5	
HPS2-5	5.0	
HPS2-6	6.0	
HPS2-7	7.0	
HPS2-8	8.0	
HPS2-9	9.0	
HPS2-10	10.0	
HPS2-11	11.0	
HPS2-12	12.0	
HPS2-12.7	12.7	

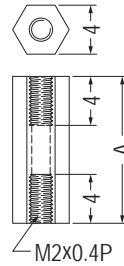
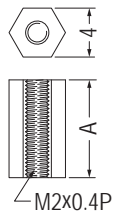

Part No.	A	Package
HPS2-13	13.0	1000
HPS2-14	14.0	
HPS2-15	15.0	
HPS2-16	16.0	
HPS2-17	17.0	
HPS2-18	18.0	
HPS2-19	19.0	
HPS2-20	20.0	
HPS2-21	21.0	
HPS2-22	22.0	
HPS2-23	23.0	
HPS2-24	24.0	
HPS2-25	25.0	

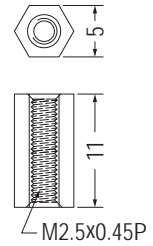
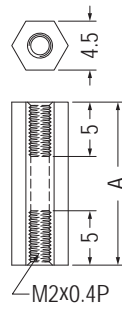
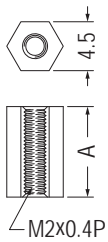

Part No.	A	Package
HP2-4	4.0	1000
HP2-5	5.0	
HP2-6	6.0	
HP2-7	7.0	
HP2-8	8.0	
HP2-9	9.0	
HP2-10	10.0	
HP2-11	11.0	
HP2-12	12.0	

Part No.	A	Package
HP2-13	13.0	1000
HP2-14	14.0	
HP2-15	15.0	
HP2-16	16.0	
HP2-17	17.0	
HP2-18	18.0	
HP2-18.8	18.8	
HP2-19	19.0	

Part No.	A	Package
HP2-20	20.0	1000
HP2-21	21.0	
HP2-22	22.0	
HP2-23	23.0	
HP2-24	24.0	
HP2-25	25.0	
HP2-26	26.0	
HP2-27	27.0	
HP2-28	28.0	

Part No.	Package
HPS2.5-11	1000

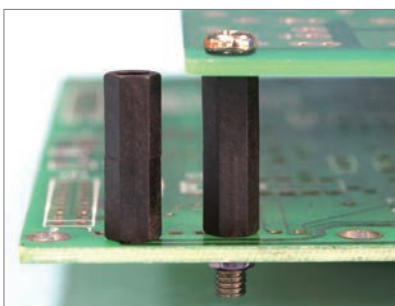

- Material: Nylon 6 (UL)
- Flame Class: 94HB
- Color: Black
- Unit: mm

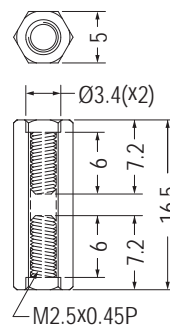

Part No.	Package
HPS2.5-16.5	1000

塑膠螺柱 PLASTIC STANDOFF

用途：做為PC板與機板間之固定，六角型不滑動。

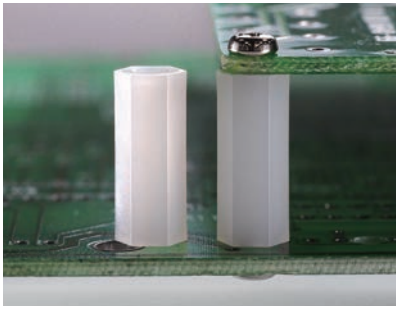

- Material: Nylon 66 (UL)
- Flame Class: 94V-2/94V-0
- Color: Natural/Black
- Unit: mm

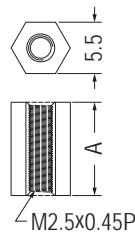

Part No.	A	Package
HP2.5-8	8.0	1000
HP2.5-10	10.0	

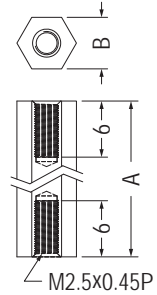

Part No.	A	B	Package
HP2.5-15	15.0	5.5	1000
HP2.5-15S	15.0	4.0	
HP2.5-25	25.0	5.5	
HP2.5-25S	25.0	4.0	
HP2.5-31	31.0	5.5	

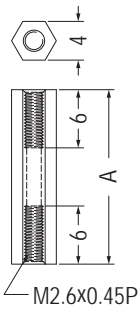

Part No.	A	Package
HPS2.6-18	18.0	1000
HPS2.6-19	19.0	
HPS2.6-31.75	31.75	

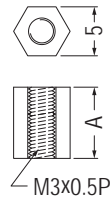

Part No.	A	Package
HPS-6	6.0	1000
HPS-8	8.0	
HPS-10	10.0	
HPS-12	12.0	

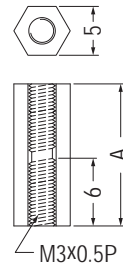

Part No.	A	Package
HPS-15	15.0	1000
HPS-17.4	17.4	
HPS-18	18.0	
HPS-20	20.0	
HPS-25	25.0	

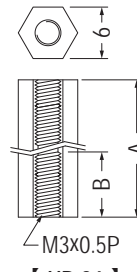
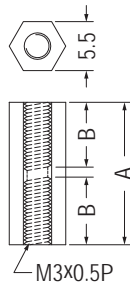

【 HP-34 】

• 產品兩端皆有螺牙可供鎖付

Part No.	A	B	Package
HP-4	4.0		1000
HP-5	5.0		
HP-6	6.0		
HP-6.3	6.35		
HP-7	7.0		
HP-8	8.0		
HP-8.5	8.5		
HP-9	9.0		
HP-9.5	9.5		
HP-10	10.0		
HP-10.5	10.5		
HP-11	11.0		
HP-12A	12.0		
HP-12	12.7		
HP-13.5	13.5	6.0	
HP-14	14.0	6.0	
HP-14.5	14.5	6.0	
HP-15	15.0	6.0	
HP-15.5	15.5	6.0	
HP-16	16.0	6.0	
HP-16.5	16.5	6.0	
HP-17	17.0	6.0	
HP-17.5	17.5	6.0	
HP-18	18.0	6.0	
HP-19	19.0	6.0	
HP-20	20.0	6.0	
HP-21.5	21.5	6.0	
HP-22	22.0	6.0	
HP-24	24.0	6.0	
HP-25	25.0	6.0	
HP-26	26.0	6.0	
HP-27	27.0	6.0	
HP-28	28.0	6.0	

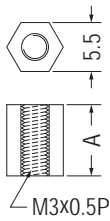

Part No.	A	Package
HP-4	4.0	1000
HP-5	5.0	
HP-6	6.0	
HP-6.3	6.35	
HP-7	7.0	
HP-8	8.0	
HP-8.5	8.5	
HP-9	9.0	
HP-9.5	9.5	
HP-10	10.0	
HP-10.5	10.5	
HP-11	11.0	
HP-12A	12.0	
HP-12	12.7	

Part No.	A	B	Package
HP-28.6	28.6	6.0	1000
HP-30	30.0	6.0	
HP-30.8	30.8	6.0	
HP-32	32.0	6.0	
HP-34	34.0	8.0	
HP-35	35.0	6.0	
HP-37	37.0	6.0	500
HP-38	38.0	6.0	
HP-40	40.0	6.0	
HP-42	42.0	6.0	
HP-45	45.0	6.0	
HP-47	47.0	6.0	
HP-49	49.0	6.0	
HP-50	50.0	6.0	
HP-52	52.0	6.0	
HP-54	54.0	6.0	
HP-55.5	55.5	8.0	
HP-60.2	60.2	6.0	
HP-70	70.0	10.0	
HP-76.7	76.7	8.5	

塑膠螺柱 PLASTIC STANDOFF

用途：做為PC板與機板間之固定，六角型不滑動。

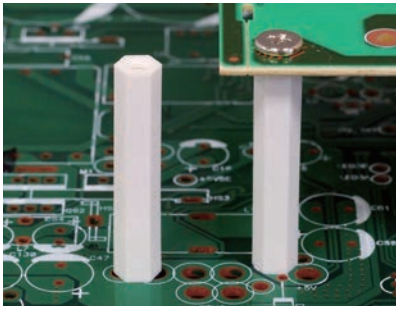

- Material: Nylon 66 (UL)
- Flame Class: 94V-2/94V-0
- Color: Natural/Black
- Unit: mm

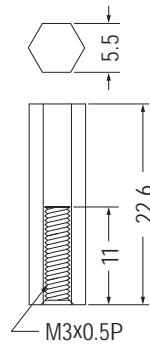

Part No.	Package
HPA3-22.6	1000

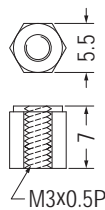
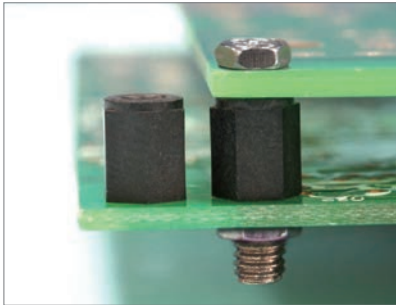

Part No.	Package
HPR3-7	1000

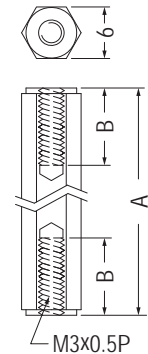

Part No.	A	B	Package
HPR-20	20.0	8.0	1000
HPR3-30	30.0	10.0	

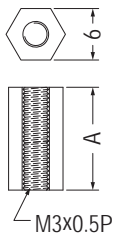

Part No.	A	Package
HPH-10	10.0	1000
HPH-12	12.0	
HPH-15	15.0	

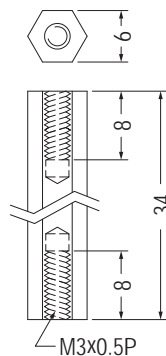

Part No.	Package
HPH-34	1000

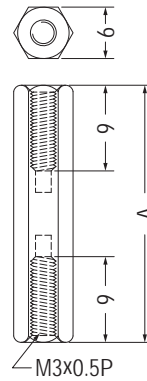

Part No.	A	Package
HPL-30	30.0	500
HPL-40	40.0	

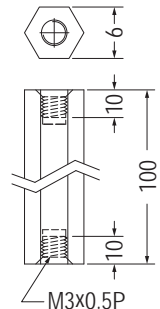

Part No.	Package
HPL-100	500

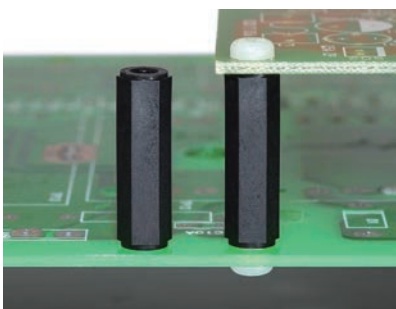

- Material: Nylon 6 (UL)+GF
- Flame Class: 94HB
- Color: Black

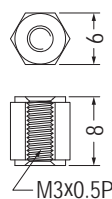

Part No.	Package
HPR-8	1000

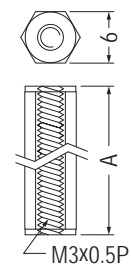

Part No.	A	Package
HPR3-11	11.0	1000
HPR3-22	22.0	

塑膠螺柱 PLASTIC STANDOFF

用途：做為PC板與機板間之固定，六角型不滑動。

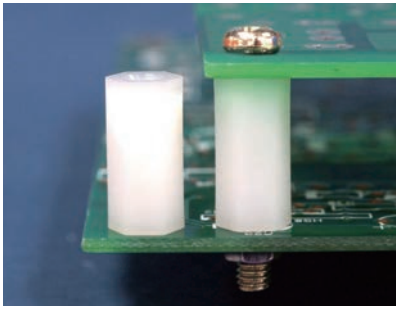

- Material: Nylon 66 (UL)
- Flame Class: 94V-2/94V-0
- Color: Natural/Black
- Unit: mm

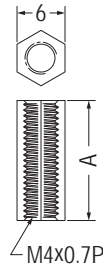

Part No.	A	Package
HPS4-6	6.0	1000
HPS4-8	8.0	
HPS4-10	10.0	
HPS4-12	12.0	
HPS4-15	15.0	
HPS4-18	18.0	
HPS4-20	20.0	

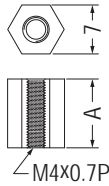

Part No.	A	Package
HP4-6	6.0	1000
HP4-7	7.0	
HP4-8	8.0	
HP4-9	9.0	
HP4-10	10.0	
HP4-11	11.0	
HP4-12	12.0	
HP4-12.7	12.7	
★HP4-14	14.0	
★HP4-15	15.0	
HP4-16	16.0	

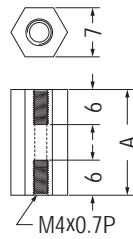

Part No.	A	Package
HP4-20	20.0	1000
HP4-25	25.0	
HP4-26	26.0	
HP4-30	30.0	
HP4-35	35.0	
HP4-40	40.0	
HP4-45S	45.0	
HP4-45	45.5	

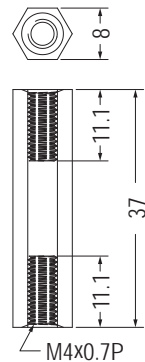

Part No.	Package
HPL4-37	1000

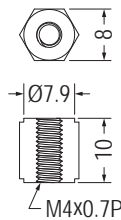
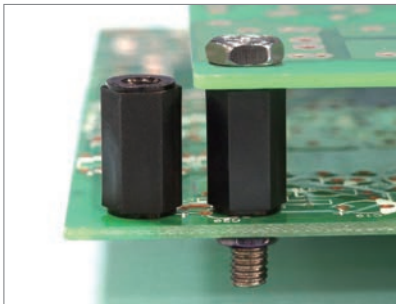

Part No.	Package
HPR4-10	1000

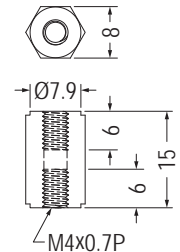

Part No.	Package
HPR4-15	1000

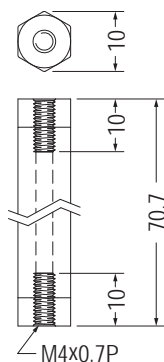
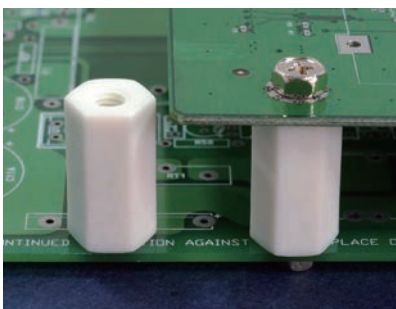

Part No.	Package
HPR4-70L	500

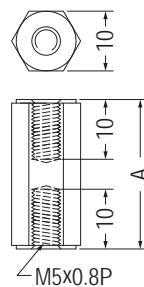

Part No.	A	Package
HPR5-25	25.0	1000
HPR5-45	45.0	500

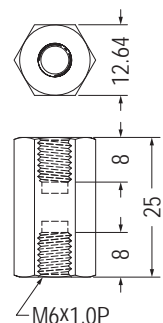

Part No.	Package
HP6-25	500

塑膠螺柱 PLASTIC STANDOFF

用途：做為斷路器保護，避免誤觸。



- Material: Nylon 66 (UL)
- Flame Class: 94V-2/94V-0
- Color: Natural/Black
- Unit: mm

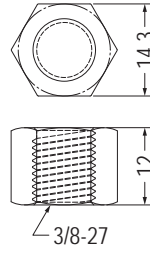

Part No.	Package
M-3/8-27	1000

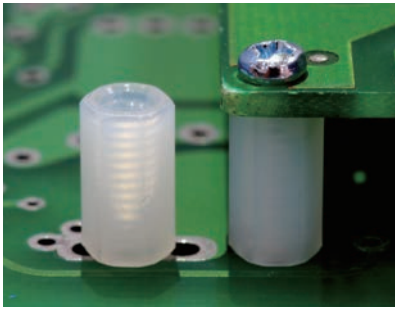

- Material: Nylon 66 (UL)
- Flame Class: 94V-2/94V-0
- Color: Natural/Black
- Unit: mm

用途：做為PC板與機板間之固定，六角型不滑動。

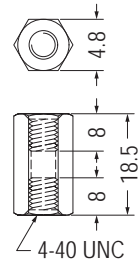
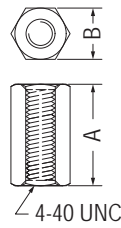

Part No.	A	B	Package
HP440-7.9S	7.9	4.75	1000
HP440-9.5	9.5	4.8	
HP440-15.9S	15.88	4.75	

Part No.	Package
HP440-18	1000

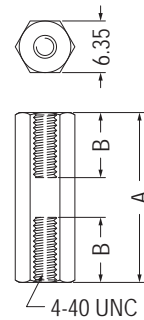
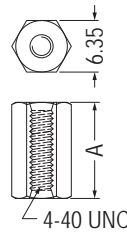
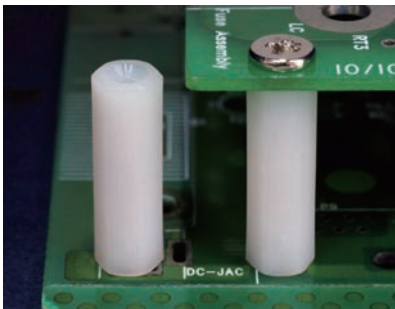

Part No.	A	Package
HP44L-6.35	6.35	1000
HP44L-8	8.0	
HP44L-9.5	9.5	
HP44L-12.7	12.7	
HP44L-15.9	15.9	
HP44L-19.1	19.1	

Part No.	A	B	Package
HP44L-22	22.2	9.0	1000
HP44L-23.8	23.8	6.4	
HP44L-25.4	25.4	9.0	
HP44L-28.6	28.6	6.4	

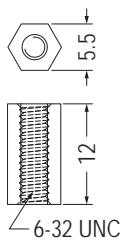
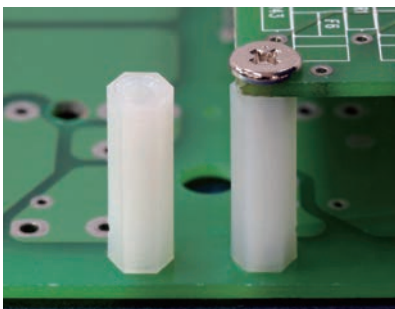

Part No.	Package
HPS632-12	1000

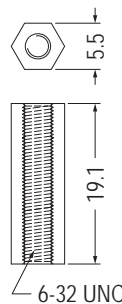

Part No.	Package
HPS632-19.1	1000

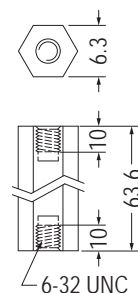

Part No.	Package
HP632-64	500

塑膠螺柱 PLASTIC STANDOFF

用途：做為PC板與機板間之固定，六角型不滑動。

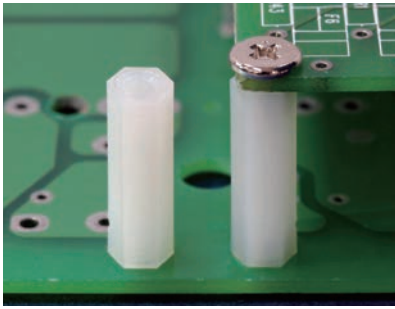

- Material: Nylon 66 (UL)
- Flame Class: 94V-2/94V-0
- Color: Natural/Black
- Unit: mm

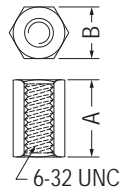

Part No.	A	B	Package
HP632-6.4	6.4	6.35	1000
HP632-9.5	9.5	6.35	
HP632-12.7	12.7	6.35	
HP632-15.9	15.9	6.35	
HP632-19.1	19.1	6.35	
HP632-22.2	22.2	6.35	
HP632-25.4	25.4	6.4	

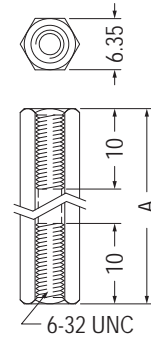

Part No.	A	Package
HP632-28.5	28.5	1000
★HP632-30	30.0	
HP632-31.8	31.8	
HP632-38.1	38.1	

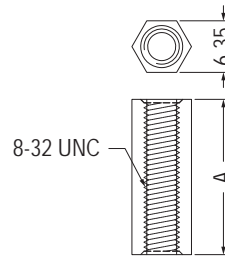
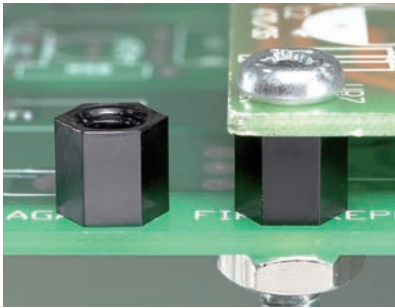

Part No.	A	Package
★HP832-12.7	12.7	1000
HP832-19.1	19.1	
HP832-25.4	25.4	

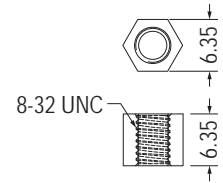

- Material: Nylon 46 (UL)
- Flame Class: 94V-2
- Color: Black

Part No.	Package
HP832-6.35	1000

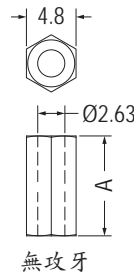
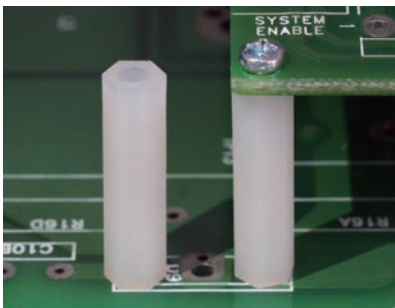

無攻牙
CLEAR WITHOUT TAPPING

Part No.	A	Package
HP48-20	20.0	1000
HP48-32	32.0	

塑膠金屬螺柱 PLASTIC STANDOFF WITH METAL INSERTS

用途：做為PC板與機板間之固定，六角型不滑動。

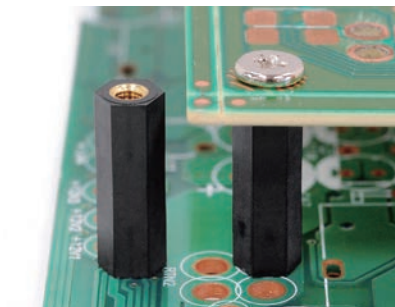

- Material: Nylon 66 (UL)
- Flame Class: 94V-2/94V-0
- Color: Natural/Black
- Unit: mm

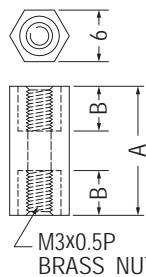

Part No.	A	B	Package
HPC-11.9	11.9	4.0	1000
HPC-15	15.0	4.5	
HPC-19	19.0	4.0	

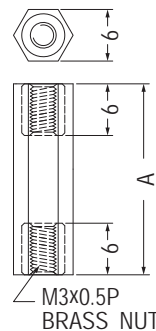

Part No.	A	Package
HPC-19	19.0	1000
HPC-30	30.0	
HPC-45	45.0	

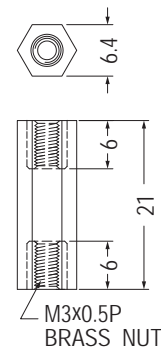

Part No.	Package
HPC-21	1000

塑膠金屬螺柱 PLASTIC STANDOFF WITH METAL INSERTS

用途：做為PC板與機板間之固定，六角型不滑動。

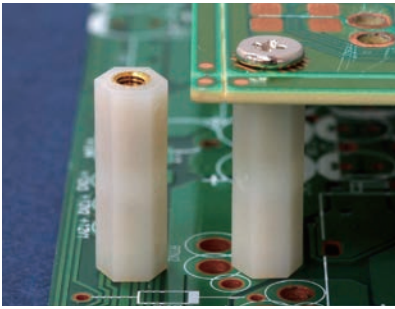

- Material: Nylon 66 (UL)
- Flame Class: 94V-2/94V-0
- Color: Natural/Black
- Unit: mm

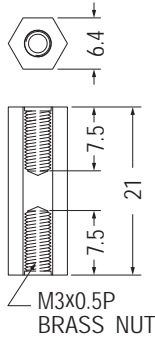

Part No.	Package
HPCA-21	1000

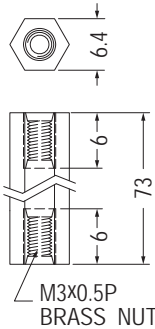

Part No.	Package
HPC-73	1000

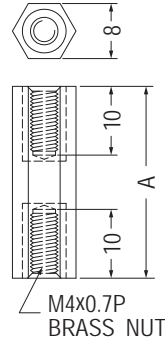

Part No.	A	Package
HPC4-30	30.0	250
HPC4-35	35.0	
HPC4-40	40.0	

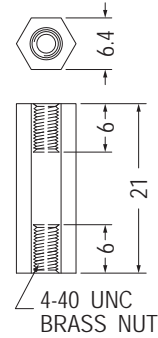

Part No.	Package
HPC4-21	1000

塑膠螺柱 PLASTIC STANDOFF

用途：做為PC板與機板間之固定，一端配合螺絲，另一端配合螺帽使用。

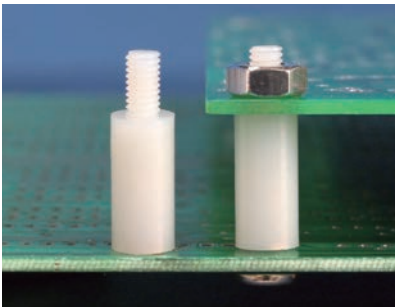

- Material: Nylon 66 (UL)
- Flame Class: 94V-2/94V-0
- Color: Natural/Black
- Unit: mm

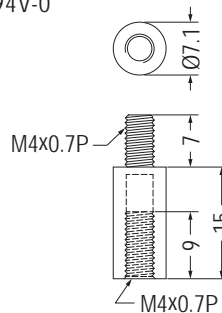

Part No.	Package
TPR4-15	1000

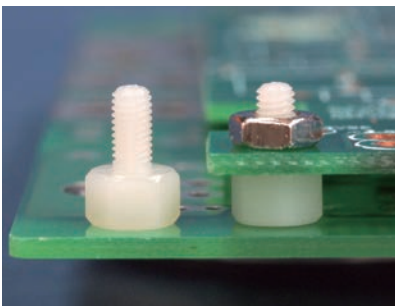

- Material: Nylon 66 (UL)
- Flame Class: 94V-2/94V-0
- Color: Natural/Black
- Unit: mm

用途：做為於零件之墊高。

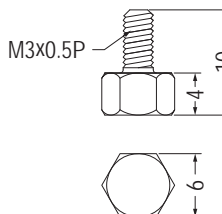

Part No.	Package
TPA-4	1000

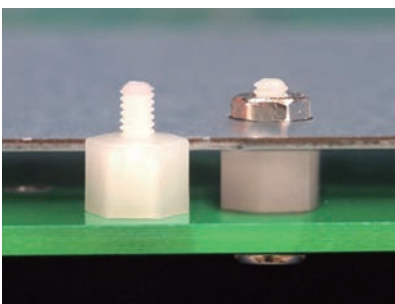

- Material: Nylon 66 (UL)
- Flame Class: 94V-2/94V-0
- Color: Natural/Black
- Unit: mm

用途：做為PC板與機板間之固定，一端配合螺絲，另一端配合螺帽使用。

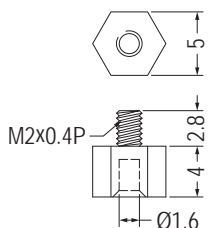

Part No.	Package
TP2L-4	1000

塑膠螺柱 PLASTIC STANDOFF

用途：做為PC板與機板間之固定，一端配合螺絲，另一端配合螺帽使用。

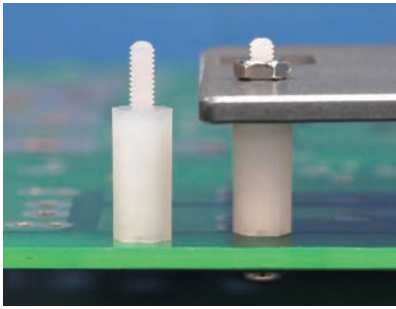

- Material: Nylon 66 (UL)
- Flame Class: 94V-2/94V-0
- Color: Natural/Black
- Unit: mm

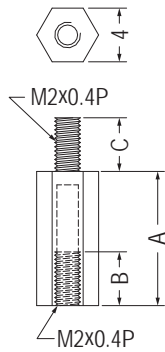

Part No.	A	B	C	Package
TP2-5S	5.0	3.0	4.0	1000
TP2-6.5S	6.5	4.0	4.0	
TP2-8S	8.0	4.0	4.0	
TP2-10S	10.0	4.0	4.0	
TP2-15S	15.0	4.0	4.0	
TP2-4	4.0	2.5	5.0	
TP2-5	5.0	3.0	5.0	
TP2-5.5	5.5	3.0	5.0	
TP2-6	6.0	4.0	5.0	
TP2-6.5	6.5	4.0	5.0	
TP2-7	7.0	4.0	5.0	
TP2-8	8.0	5.0	5.0	
TP2-9	9.0	5.0	5.0	
TP2-10	10.0	5.0	5.0	
TP2-11	11.0	5.0	5.0	
TP2-12	12.0	5.0	5.0	

Part No.	A	B	C	Package
TP2-13	13.0	5.0	5.0	1000
TP2-14	14.0	5.0	5.0	
TP2-15	15.0	5.0	5.0	
TP2-16	16.0	5.0	5.0	
TP2-17	17.0	5.0	5.0	
TP2-18	18.0	5.0	5.0	
TP2-19	19.0	5.0	5.0	
TP2-20	20.0	5.0	5.0	
TP2-21	21.0	5.0	5.0	
TP2-22	22.0	5.0	5.0	
TP2-23	23.0	5.0	5.0	
TP2-24	24.0	5.0	5.0	
TP2-25	25.0	5.0	5.0	
TP2-26	26.0	5.0	5.0	
TP2-27	27.0	5.0	5.0	
TP2-28	28.0	5.0	5.0	

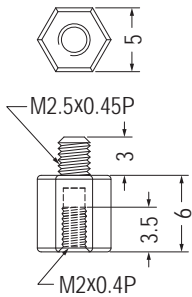

Part No.	Package
TP2.5-2-6	1000

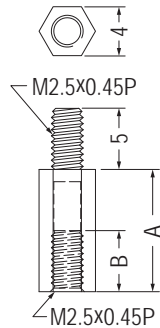

Part No.	A	B	Package
TP2.5-5	5.0	3.0	1000
TP2.5-6	6.0	4.0	
TP2.5-7	7.0	5.0	
TP2.5-8	8.0	5.0	
TP2.5-9	9.0	5.0	
TP2.5-10	10.0	5.0	
TP2.5-11	11.0	5.0	
TP2.5-12	12.0	5.0	
TP2.5-13	13.0	5.0	
TP2.5-14	14.0	5.0	
TP2.5-15	15.0	5.0	
TP2.5-16	16.0	5.0	

Part No.	A	B	Package
TP2.5-17	17.0	5.0	1000
TP2.5-18	18.0	5.0	
TP2.5-19	19.0	5.0	
TP2.5-20	20.0	5.0	
TP2.5-21	21.0	5.0	
TP2.5-22	22.0	5.0	
TP2.5-23	23.0	5.0	
TP2.5-24	24.0	5.0	
TP2.5-24.5	24.5	5.0	
TP2.5-25	25.0	5.0	
TP2.5-26	26.0	5.0	
TP2.5-27	27.0	5.0	
TP2.5-28	28.0	5.0	

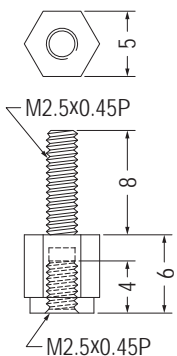

Part No.	Package
TP2.5-6L	1000

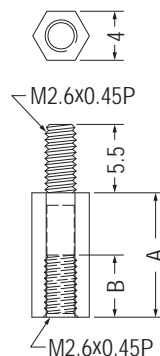

Part No.	A	B	Package
TP2.6-4	4.0	2.0	1000
TP2.6-5	5.0	3.0	
TP2.6-6	6.0	4.0	
TP2.6-7	7.0	5.0	
TP2.6-8	8.0	5.5	
TP2.6-9	9.0	5.5	
TP2.6-10	10.0	5.5	
TP2.6-11	11.0	5.5	
TP2.6-12	12.0	5.5	
TP2.6-12.7	12.7	5.5	
TP2.6-13	13.0	5.5	
TP2.6-14	14.0	5.5	
TP2.6-15	15.0	5.5	

Part No.	A	B	Package
TP2.6-16	16.0	5.5	1000
TP2.6-17	17.0	5.5	
TP2.6-18	18.0	5.5	
TP2.6-19	19.0	5.5	
TP2.6-20	20.0	5.5	
TP2.6-21	21.0	5.5	
TP2.6-22	22.0	5.5	
TP2.6-23	23.0	5.5	
TP2.6-24	24.0	5.5	
TP2.6-25	25.0	5.5	
TP2.6-26	26.0	5.5	
TP2.6-27	27.0	5.5	
TP2.6-28	28.0	5.5	

塑膠螺柱 PLASTIC STANDOFF

用途：做為PC板與機板間之固定，一端配合螺絲，另一端配合螺帽使用。

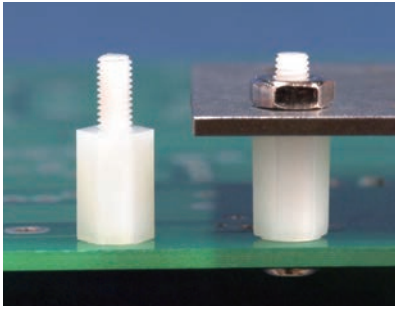
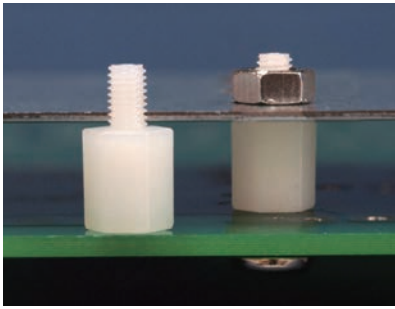

- Material: Nylon 66 (UL)
- Flame Class: 94V-2/94V-0
- Color: Natural/Black
- Unit: mm

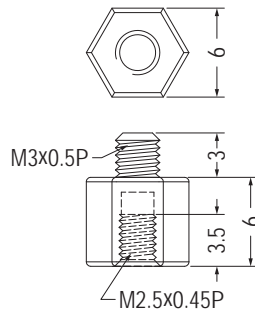

Part No.	Package
TP3-2.5-6	1000

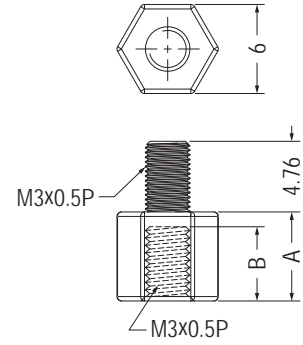

Part No.	A	B	Package
TP3-6	6.0	5.0	1000
TP3-7.5	7.5	6.25	

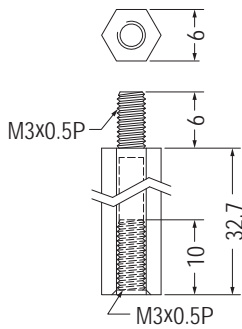

Part No.	Package
TP-32.7L	1000

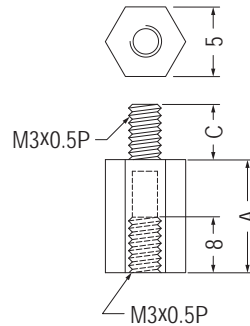

Part No.	A	C	Package
TPS-10S	10.0	5.0	1000
TPS-10	10.0	8.0	
TPS-12	12.0	8.0	
TPS-13	13.0	8.0	
TPS-15	15.0	8.0	
TPS-18	18.0	8.0	
TPS-20	20.0	8.0	
TPS-25	25.0	8.0	

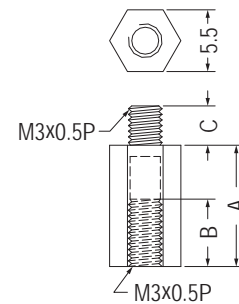

Part No.	A	B	C	Package
TP-5S	5.0	4.0	3.5	1000
TP-5SM	5.0	4.0	5.0	
TP-6S	6.0	4.0	5.0	
TP-7-4	7.0	5.0	4.0	
TP-9-4	9.0	6.0	4.0	
TP-10.8	10.8	6.0	3.5	
TP-11.2	11.2	6.0	3.5	
TP-16S	16.0	6.0	4.0	
TP-18S	18.0	6.0	5.0	
TP-20S	20.0	8.0	5.0	

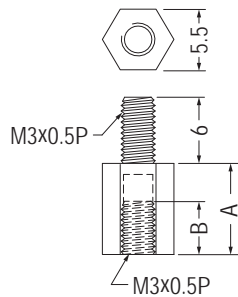

Part No.	A	B	Package
TP-4	4.0	3.0	1000
TP-5	5.0	3.0	
TP-6	6.0	4.0	
TP-7	7.0	5.0	
TP-7.5	7.5	5.0	
TP-8	8.0	6.0	
TP-8.5	8.5	6.0	
TP-9	9.0	6.0	

Part No.	A	B	Package
TP-9.5	9.5	6.0	1000
TP-10	10.0	6.0	
TP-10.5	10.5	6.0	
TP-10.8L	10.8	6.0	
TP-11	11.0	6.0	
TP-12A	12.0	6.0	
TP-12	12.7	6.0	
TP-13	13.0	6.0	
TP-14	14.0	6.0	
TP-15	15.0	6.0	
TP-15.5	15.5	6.0	
TP-16	16.0	6.0	
TP-16.5	16.5	6.0	
TP-17	17.0	6.0	
TP-18	18.0	6.0	
TP-18.5	18.5	6.0	
TP-19	19.0	6.0	
TP-20	20.0	8.0	

Part No.	A	B	Package
TP-21	21.0	6.0	1000
TP-22	22.0	6.0	
★TP-23	23.0	6.0	
TP-24.5	24.5	6.0	
TP-25	25.0	6.0	
TP-27	27.0	6.0	
TP-28	28.0	6.0	
TP-28.5	28.5	6.0	
TP-30	30.0	8.0	
TP-33	33.0	6.0	
TP-34.5	34.5	6.0	
TP-35	35.0	6.0	
TP-36	36.0	6.0	
TP-37	37.0	6.0	
TP-40	40.0	6.0	
TP-45	45.0	6.0	
TP-53.5	53.5	6.0	
TP-55.5	55.5	8.0	

塑膠螺柱 PLASTIC STANDOFF

1

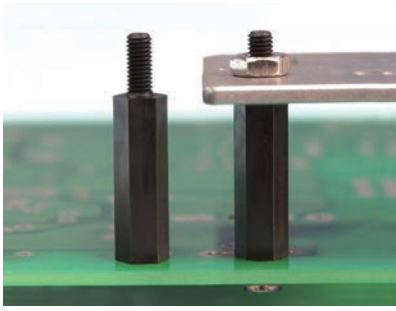

- Material: Nylon 66 (UL)
- Flame Class: 94V-2/94V-0
- Color: Natural/Black
- Unit: mm

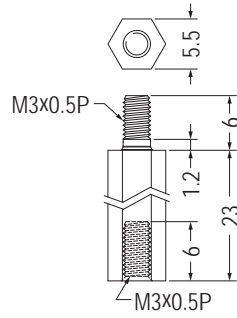

Part No.	Package
★ TP-23-1	1000

用途：做為PC板與機板間之固定，一端配合螺絲，另一端配合螺帽使用。

- Material: POM
- Color: Black
- Unit: mm

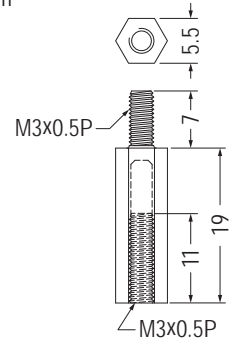

Part No.	Package
TPD-19	1000

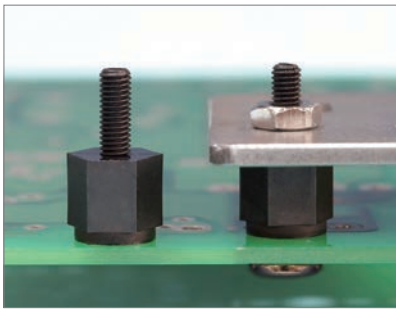

- Material: Nylon 66 (UL)
- Flame Class: 94V-2/94V-0
- Color: Natural/Black
- Unit: mm

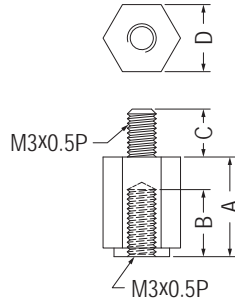

Part No.	A	B	C	D	Package
TP3-6L	6.0	4.0	8.0	6.0	1000
TP3-8L	8.0	6.0	8.0	6.0	
TP3-10L	10.0	8.0	8.0	6.0	
TP3-10.4	10.4	7.0	5.0	7.0	
TP3-11L	11.0	9.0	8.0	6.0	
TP3-12L	12.0	10.0	8.0	6.0	
TP3-15L	15.0	10.0	8.0	6.0	
TP3-18L	18.0	10.0	8.0	6.0	500
TP3-50L	50.0	10.0	8.0	6.0	

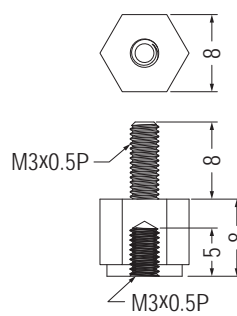
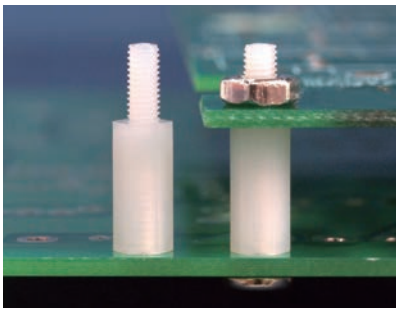

Part No.	Package
TP-8L	1000

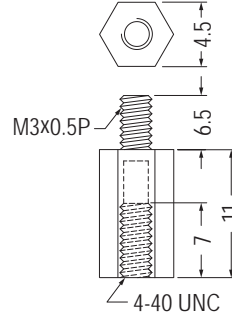

Part No.	Package
TPS44-11	1000

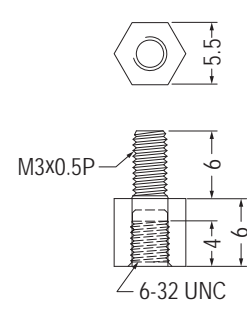

Part No.	Package
TPS632-6	1000

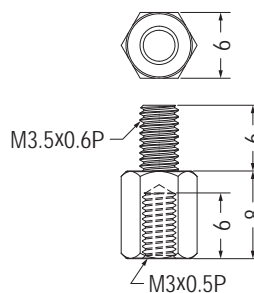
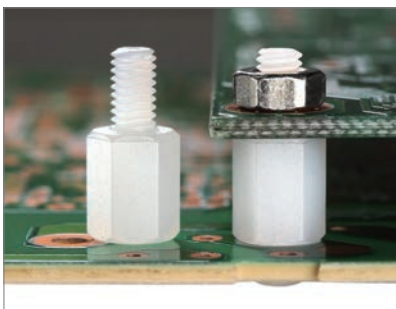

Part No.	Package
TP3.5-3-8	1000



塑膠螺柱 PLASTIC STANDOFF

用途：做為PC板與機板間之固定，一端配合螺絲，另一端配合螺帽使用。

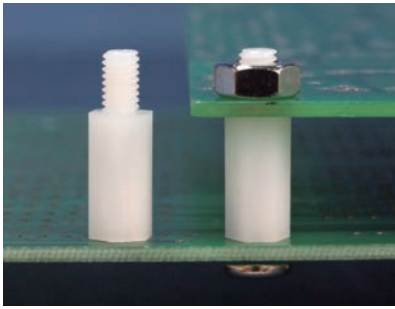

- Material: Nylon 66 (UL)
- Flame Class: 94V-2/94V-0
- Color: Natural/Black
- Unit: mm

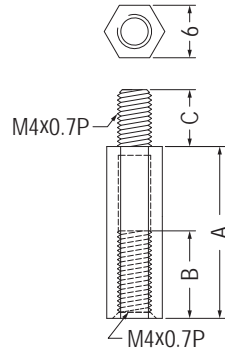

Part No.	A	B	C	Package
TPS4-10L	10.0	8.0	9.5	1000
TPS4-12L	12.0	8.0	9.5	
TPS4-13	13.0	6.0	6.5	
TPS4-15L	15.0	12.0	9.5	
TPS4-20L	20.0	12.0	9.5	
TPS4-25L	25.0	12.0	9.5	
TPS4-30	30.0	10.0	6.5	
TPS4-55	55.0	10.0	6.5	

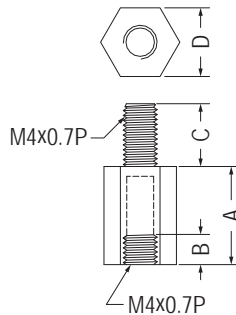
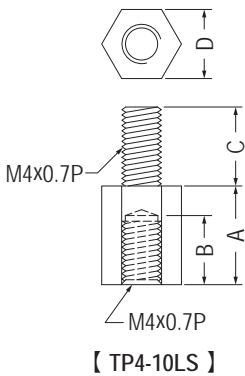

Part No.	A	B	C	D	Package
TP4-6	6.0	4.0	6.5	7.0	1000
TP4-8	8.0	6.0	6.5	7.0	
TP4-10	10.0	6.0	6.5	7.0	
TP4-10LS	10.0	7.0	8.0	7.0	
TP4-10L	10.0	7.0	8.0	8.0	

Part No.	A	B	C	D	Package
TP4-12	12.0	6.0	6.5	7.0	1000
TP4-13	13.0	6.0	6.5	7.0	
TP4-14	14.0	6.0	6.5	7.0	
TP4-15	15.0	6.0	6.5	7.0	
TP4-16	16.0	7.0	6.5	7.0	
TP4-17	17.0	7.0	6.5	7.0	
TP4-19	19.0	7.0	6.5	7.0	
TP4-20	20.0	8.0	6.5	7.0	
TP4-25	25.0	8.0	6.5	7.0	
TP4-27	27.0	8.0	6.5	7.0	
TP4-30	30.0	8.0	6.5	7.0	
TP4-34	34.0	8.0	6.5	7.0	
TP4-35	35.0	8.0	6.5	7.0	
TP4-37	37.0	8.0	6.5	7.0	
TP4-40	40.0	8.0	6.5	7.0	
TP4-45	45.5	8.0	6.5	7.0	
TP4-57	57.0	8.0	6.5	7.0	

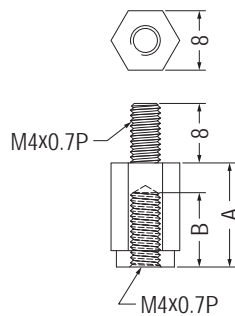
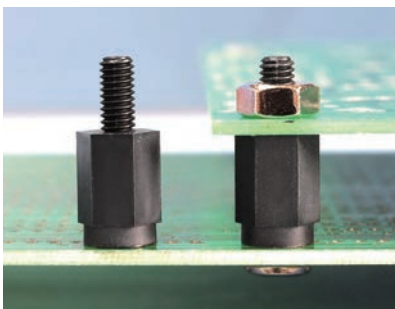

Part No.	A	B	Package
TP4-8L	8.0	6.0	1000
TP4-10R	10.0	8.0	
TP4-11R	11.0	9.0	
TP4-12L	12.0	10.0	
TP4-14L	14.0	10.0	
TP4-20L	20.0	10.0	
TP4-32L	32.0	10.0	500
TP4-35L	35.0	10.0	1000

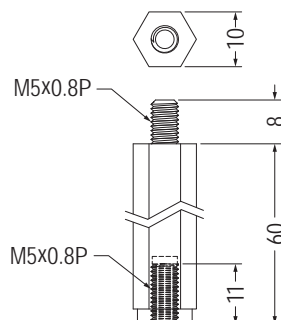
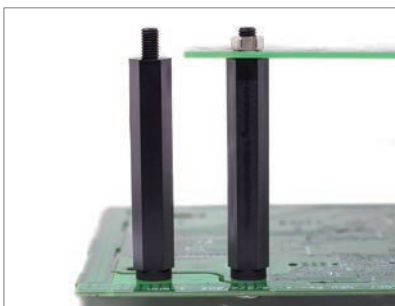

Part No.	Package
TP5-60	250

塑膠螺柱 PLASTIC STANDOFF

用途：做為PC板與機板間之固定，一端配合螺絲，另一端配合螺帽使用。

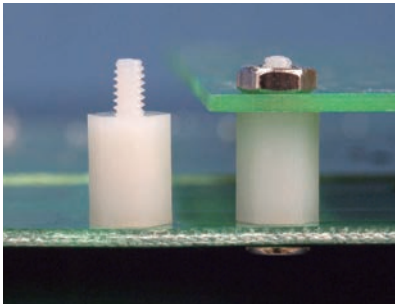

- Material: Nylon 66 (UL)
- Flame Class: 94V-2/94V-0
- Color: Natural/Black
- Unit: mm

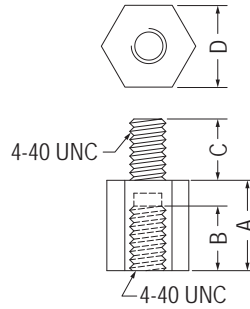

Part No.	A	B	C	D	Package
TP440-6.4	6.4	4.0	4.8	6.4	1000
TP440-6.4-4.8	6.4	4.8	4.8	6.4	
TP440-7	7.0	4.0	4.8	6.4	
TP440-8S	8.0	6.35	4.8	4.8	
TP440-9.5	9.5	6.0	4.8	6.4	
TP440-12.7	12.7	6.0	4.8	6.4	
TP440-15.2	15.24	4.75	4.75	6.35	
TP440-15.9	15.9	6.0	4.8	6.4	
TP440-19.1	19.1	6.0	4.8	6.4	
TP440-19.1S	19.05	6.35	4.75	4.75	
TP440-22.2	22.2	4.75	4.75	6.35	
TP440-25.4	25.4	4.75	4.75	6.35	
TP440-28.7	28.7	6.0	4.8	6.4	

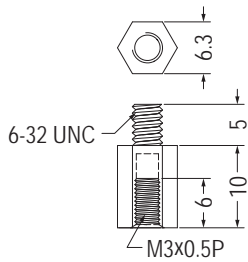

Part No.	Package
TP632-M310	1000

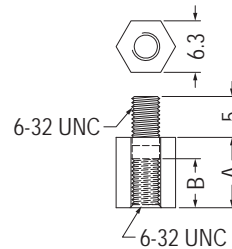

Part No.	A	B	Package
TP632-5S	5.0	3.0	1000
TP632-5.5S	5.5	3.5	
TP632-6S	6.0	4.0	
TP632-6.3S	6.3	4.0	
TP632-8S	8.0	6.0	
TP632-9S	9.0	6.0	
TP632-10S	10.0	6.0	

Part No.	A	B	Package
TP632-11S	11.0	6.0	1000
TP632-12S	12.0	6.0	
TP632-12.7S	12.7	6.0	
TP632-15.9S	15.9	6.0	
TP632-19.1S	19.1	6.0	
TP632-25.4S	25.4	6.0	
TP632-31.8S	31.8	6.0	

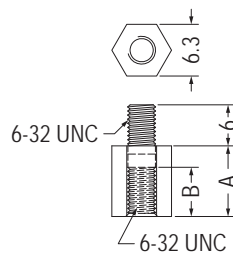

Part No.	A	B	Package
TP632-5	5.0	3.0	1000
TP632-5.5	5.5	3.5	
TP632-6	6.0	4.0	
TP632-6.3	6.3	4.0	
TP632-8	8.0	6.0	
TP632-9	9.0	6.0	
★TP632-9.5	9.5	6.0	
TP632-10	10.0	6.0	

Part No.	A	B	Package
TP632-11	11.0	6.0	1000
TP632-12	12.0	6.0	
TP632-12.7	12.7	6.0	
TP632-15.9	15.9	6.0	
TP632-19.1	19.1	6.0	
TP632-25.4	25.4	6.0	
TP632-28.6	28.6	9.5	
TP632-31.8	31.8	6.0	
TP632-51	51.0	6.0	

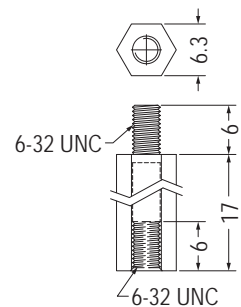

- Material: Nylon 46 (UL)
- Flame Class: 94V-2
- Color: Black

Part No.	Package
TP632-17	1000

塑膠螺柱 PLASTIC STANDOFF



- Material: Nylon 66 (UL)
- Flame Class: 94V-2/94V-0
- Color: Natural/Black
- Unit: mm

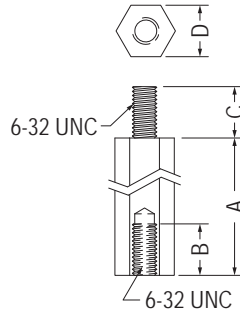

Part No.	A	B	C	D	Package
TP632-9.5L	9.5	6.4	6.4	6.4	1000
TP632-17.5L	17.5	6.4	6.4	6.4	
TP632-31.8L	31.8	6.35	6.35	6.35	
TP632-34.9L	34.9	6.35	6.35	6.35	
TP632-38.1L	38.1	6.35	6.35	6.35	
TP632-41.3L	41.3	6.35	6.35	6.35	500
TP632-44.5L	44.5	6.35	6.35	6.35	
TP632-50.8L	50.8	6.35	6.35	6.35	

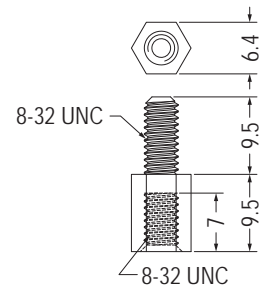
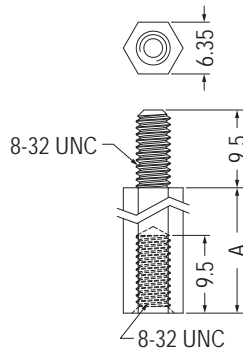

Part No.	A	Package
TP832-12.7	12.7	1000
TP832-19.1	19.1	
TP832-22.2	22.2	

- Material: Nylon 46 (UL)
- Flame Class: 94V-2
- Color: Black

Part No.	Package
TP832-9.5	1000

塑膠金屬螺柱 PLASTIC STANDOFF WITH METAL INSERTS

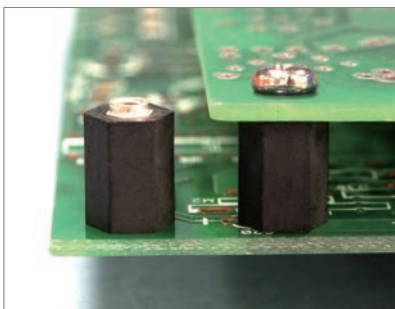

- Material: Nylon 66 (UL)
- Flame Class: 94V-2/94V-0
- Color: Natural/Black
- Unit: mm

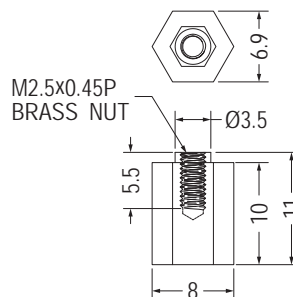

Part No.	Package
HPB2.5-10	1000

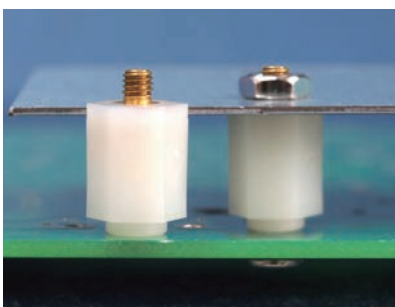

- Material: Nylon 66 (UL)
- Flame Class: 94V-2/94V-0
- Color: Natural/Black
- Unit: mm

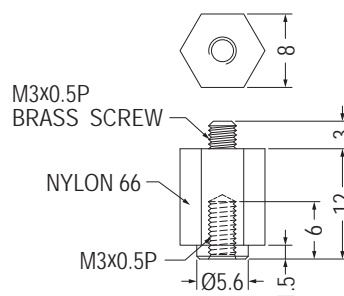

Part No.	Package
MTPE3-12	1000

用途：做為PC板與機板間之固定，一端配合螺絲，另一端配合螺帽使用。

用途：PC板與PC板間之固定，不佔空間。

用途：做為PC板與機板間之固定，一端配合螺絲，另一端配合螺帽使用。

塑膠金屬螺柱 PLASTIC STANDOFF WITH METAL INSERTS

1

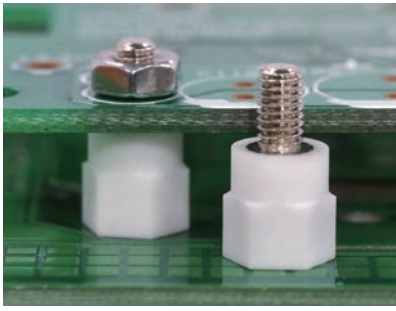

- Material: Nylon 6 (UL)
- Flame Class: 94V-0
- Color: Natural
- Unit: mm

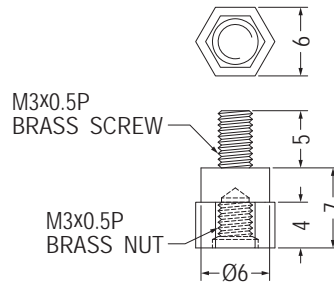

用途：做為PC板與機板間之固定，一端配合螺絲，另一端配合螺帽使用。

Part No.	Package
MTPF3-7	1000

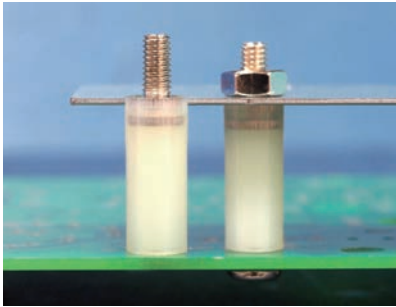

- Material: Nylon 66 (UL)
- Flame Class: 94V-2/94V-0
- Color: Natural/Black
- Unit: mm

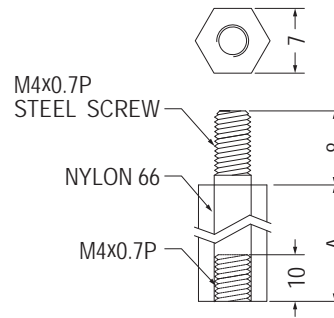

Part No.	A	Package
MTPC4-20	20.0	1000
MTPC4-57	57.0	

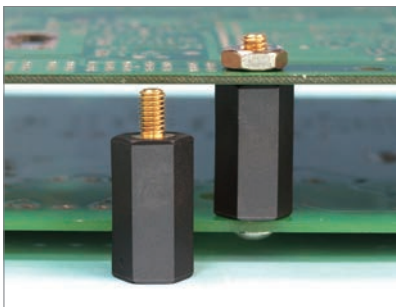

- Material: Nylon 66 (UL)
- Flame Class: 94V-2/94V-0
- Color: Natural/Black
- Unit: mm

用途：PC板與PC板間之固定，不佔空間。

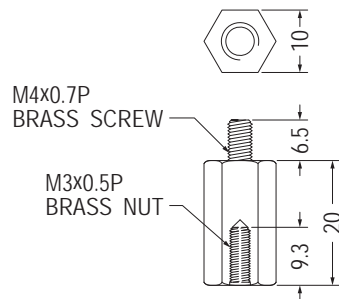

Part No.	Package
MTPA4-3-20	1000

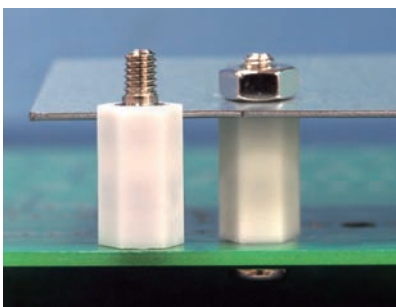

- Material: Nylon 66 (UL)
- Flame Class: 94V-2/94V-0
- Color: Natural/Black
- Unit: mm

用途：做為PC板與機板間之固定，一端配合螺絲，另一端配合螺帽使用。

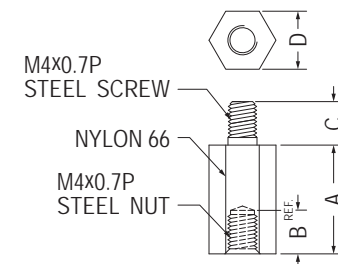
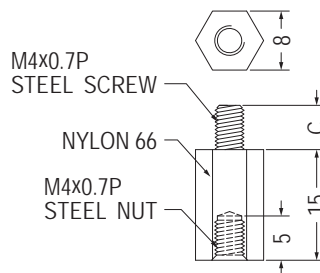

Part No.	C	Package
MTPA4-15-1	6.0	1000
MTPA4-15L	8.0	

Part No.	A	B	C	D	Package
MTPA4-15	15.0	5.0	6.0	8.0	1000
MTPA4-50L	50.0	6.0	8.0	9.0	200

塑膠金屬螺柱 PLASTIC STANDOFF WITH METAL INSERTS

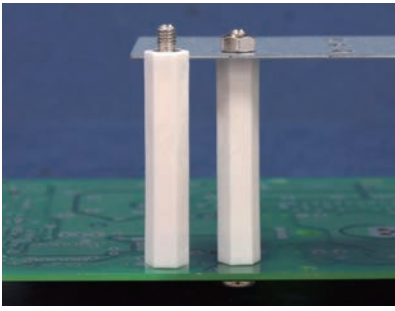

- Material: Nylon 66 (UL)
- Flame Class: 94V-2/94V-0
- Color: Natural/Black
- Unit: mm

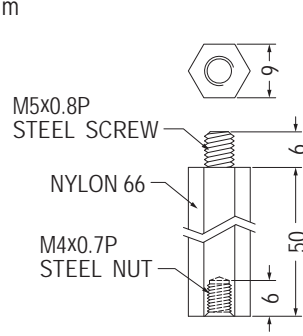

Part No.	Package
MTPA5-4-50	250

用途：做為PC板與機板間之固定，一端配合螺絲，另一端配合螺帽使用。

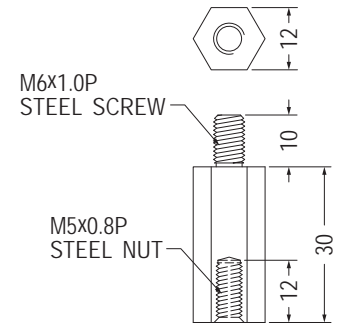

Part No.	Package
MTPA6-5-30	1000

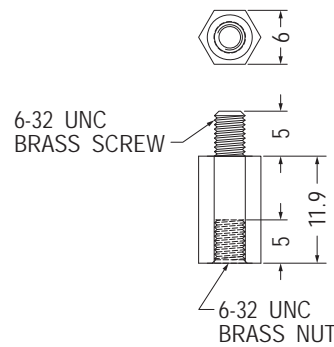
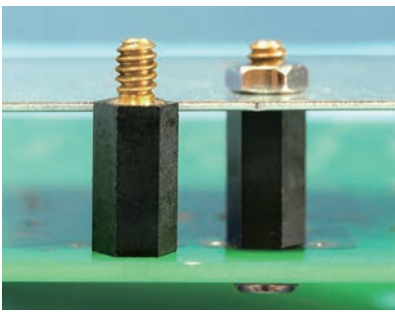

Part No.	Package
MTPD632-11.9	1000

金屬柱 METAL STANDOFF

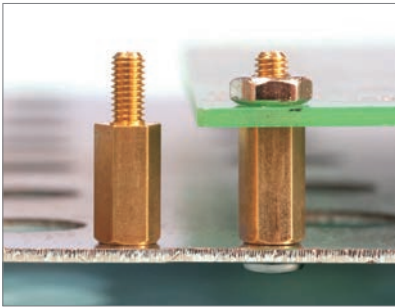

- Material: Brass
- Unit: mm

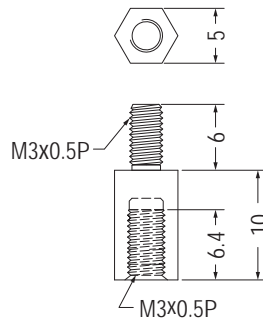

Part No.	Package
TP-10BA	1000

用途：做為PC板與機板間之固定，一端配合螺絲，另一端配合螺帽使用。

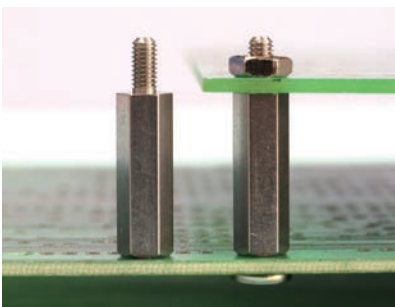

- Material: Steel/SUS
- Unit: mm

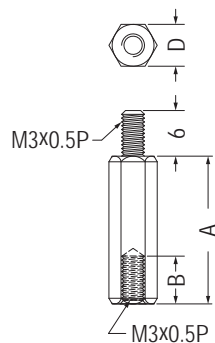

Part No.	A	B	D	Package
TP-18SUS	18.0	8.0	5.5	500
TP-25ST	25.0	6.0	5.0	
TP-30SUS	30.0	6.0	5.0	
TP-55SUS	54.9	8.0	5.5	

金屬柱 METAL STANDOFF

用途：做為PC板與機板間之固定，一端配合螺絲，另一端配合螺帽使用。

1

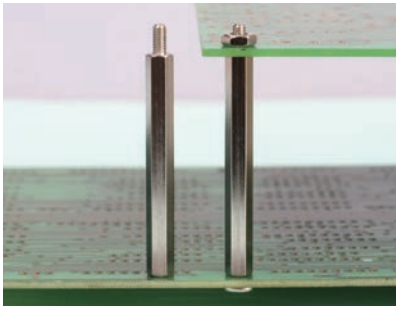

- Material: Steel
- Unit: mm

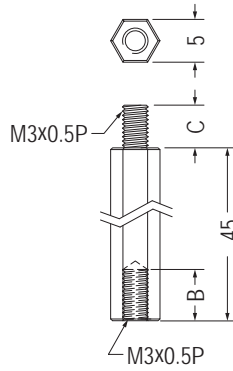

Part No.	B	C	Package
TP3-45ST	5.5	6.0	500
TP3-45LST	6.0	7.0	

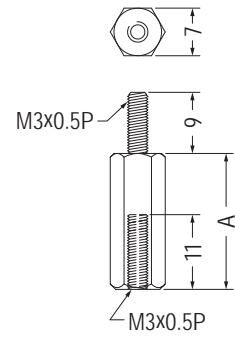

Part No.	A	Package
TPB3-20NI	20.0	500
TPB3-40NI	40.0	

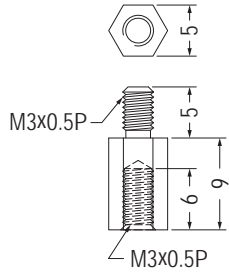
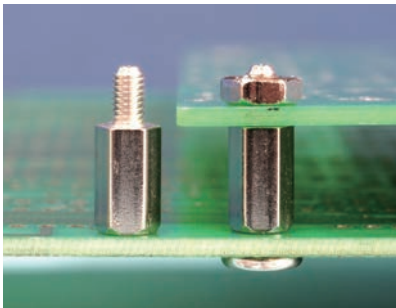

Part No.	Package
TP3-9ST	1000

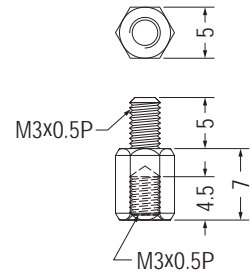

Part No.	Package
TPS3-7ST	1000

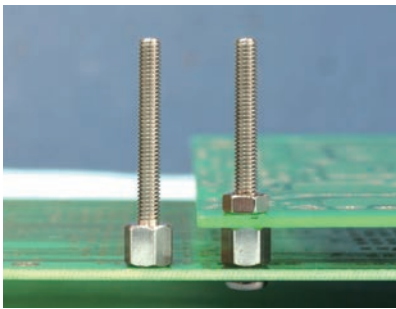

- Material: SUS
- Unit: mm

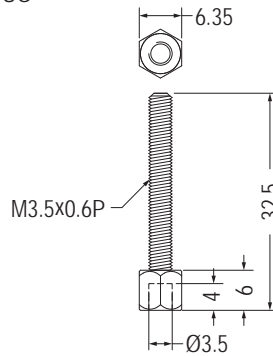

Part No.	Package
TP-6ST	500

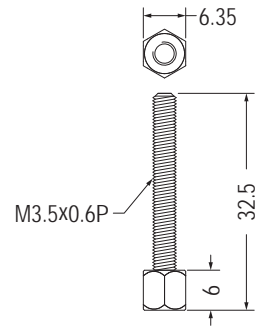

Part No.	Package
TP-6ST-1	500

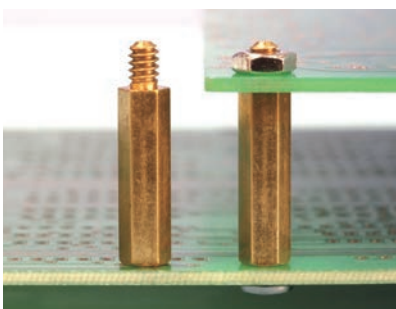

- Material: Brass
- Unit: mm

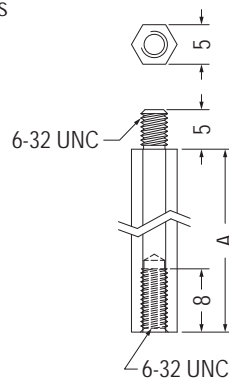

Part No.	A	Package
TP632-19.05BA	19.05	500
TP632-25.4BA	25.4	

塑膠金屬螺柱 PLASTIC STANDOFF WITH METAL INSERTS

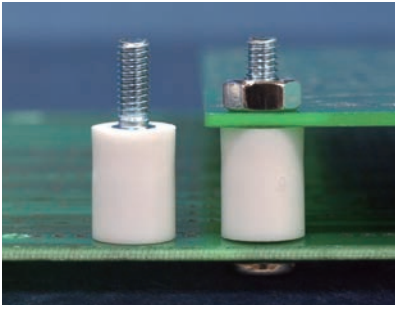

- Material: Nylon 66 (UL)
- Flame Class: 94V-2/94V-0
- Color: Natural/Black
- Unit: mm

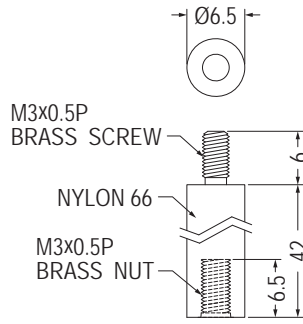

Part No.	Package
MTPG3-42	500

用途：做為PC板與機板間之固定，一端配合螺絲，另一端配合螺帽使用。

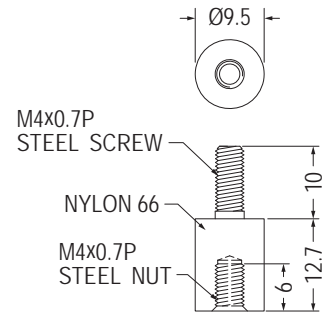

Part No.	Package
MTP4-12.7	1000

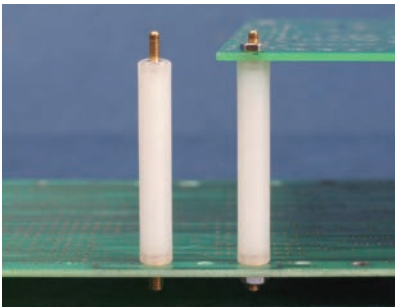

- Material: Nylon 66 (UL)
- Flame Class: 94V-2/94V-0
- Color: Natural/Black
- Unit: mm

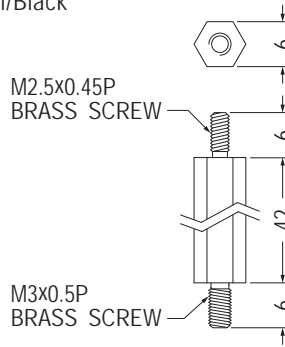

Part No.	Package
TPIM2.5-3-42	500

用途：做為PC板與機板間之固定，兩端配合攻牙或螺母使用。

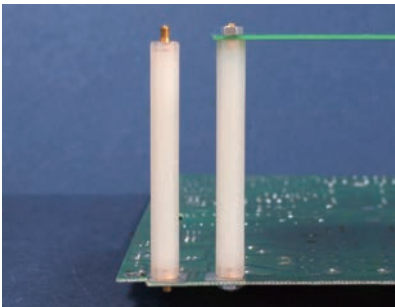

- Material: Nylon 6
- Color: Natural
- Unit: mm

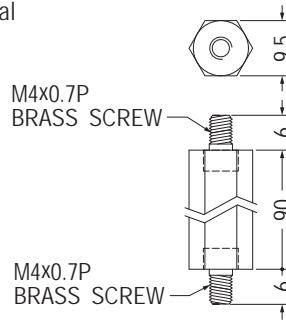

Part No.	Package
TPIM4-90	500

塑膠螺柱 PLASTIC STANDOFF

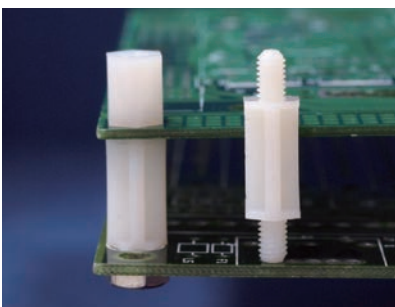

- Material: Nylon 66 (UL)
- Flame Class: 94V-2/94V-0
- Color: Natural/Black
- Unit: mm

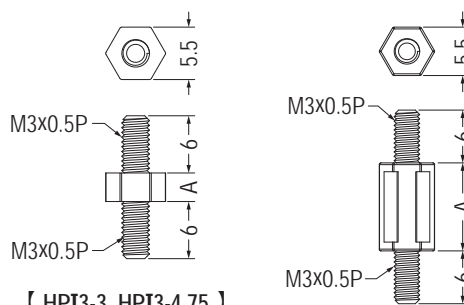

【 HPI3-3, HPI3-4.75 】

用途：做為PC板與機板間之固定，兩端配合攻牙或螺母使用。

Part No.	A	Package
HPI3-3	3.0	1000
HPI3-4.75	4.75	
HPI3-5	5.0	
HPI3-5.5	5.5	
HPI3-10	10.0	
HPI3-15	15.0	

塑膠螺柱 PLASTIC STANDOFF

用途：做為PC板與機板間之固定，兩端配合攻牙或螺母使用。

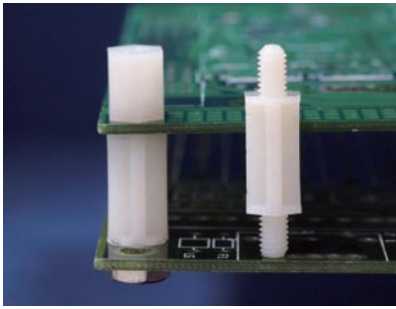

- Material: Nylon 66 (UL)
- Flame Class: 94V-2/94V-0
- Color: Natural/Black
- Unit: mm

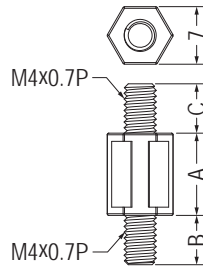

Part No.	A	B	C	Package
HPI4-5	5.0	6.0	6.0	1000
HPI4-10	10.0	6.0	6.0	
HPI4-15	15.0	6.0	6.0	
HPI4-17L	17.0	8.0	8.0	
HPI4-19	19.0	6.0	6.0	
★HPI4-19L	19.0	9.0	9.0	
HPI4-25	25.0	6.0	6.0	

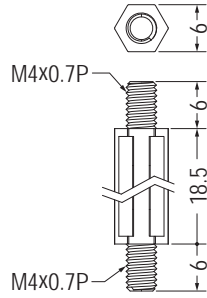

Part No.	Package
HPIB4-18.5	1000

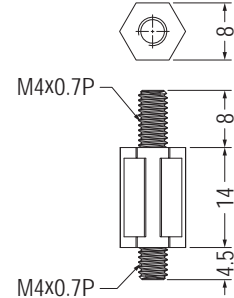

Part No.	Package
HPIB4-14	1000

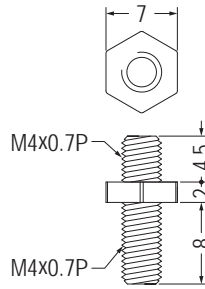
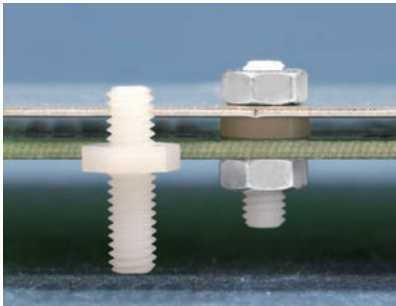

Part No.	Package
HPIA4-2	1000

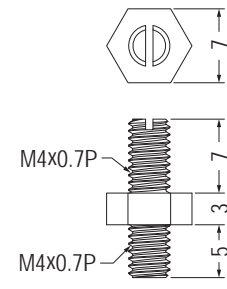

Part No.	Package
HPIE4-3	1000

PCB間隔柱 PCB SPACER

用途：PC板端直接壓入固定，另一端可配合螺母或攻牙。

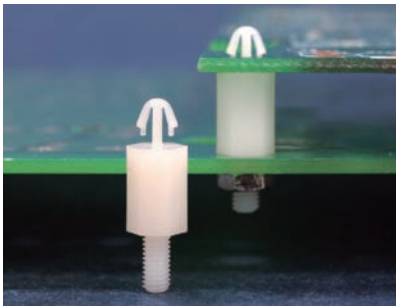

- Material: Nylon 66 (UL)
- Flame Class: 94V-2/94V-0
- Color: Natural/Black
- Unit: mm

MOUNTING HOLE Ø3.0
THICKNESS 1.6

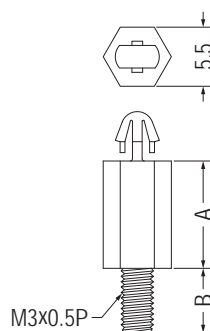

Part No.	A	B	Package
SCBA-3	3.0	6.3	1000
SCBA-3S	3.0	3.0	
SCBA-4	4.0	6.3	
SCBA-5	5.0	6.3	
SCBA-5S	5.0	4.5	
SCBA-6	6.0	6.3	
SCBA-6S	6.0	4.5	
SCBA-7	7.0	6.3	
SCBA-8	8.0	6.3	
SCBA-9	9.0	6.3	
SCBA-10	10.0	6.3	
SCBA-11	11.0	6.3	
SCBA-12	12.0	6.3	
SCBA-13	13.0	6.3	
SCBA-14	14.0	6.3	
SCBA-15	15.0	6.3	
SCBA-16	16.0	6.3	

PCB間隔柱 PCB SPACER

用途：PC板端直接壓入固定，另一端可配合螺母或攻牙。

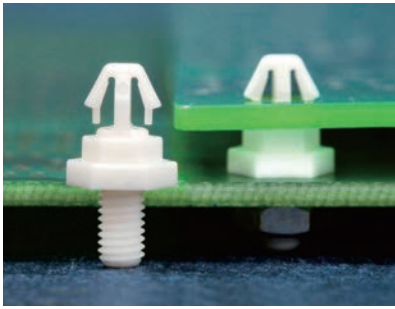

- Material: Nylon 66 (UL)
- Flame Class: 94V-2/94V-0
- Color: Natural/Black
- Unit: mm

MOUNTING HOLE Ø3.5
THICKNESS 0.8

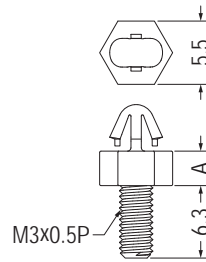

Part No.	A	Package
SCBC-3	3.0	1000
SCBC-4.75	4.76	
SCBC-5.5	5.5	2000

MOUNTING HOLE Ø3.5
THICKNESS 1.6

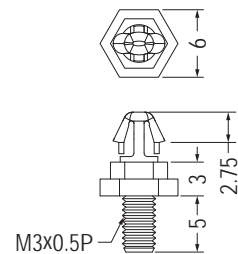

Part No.	Package
SCBB-3	1000

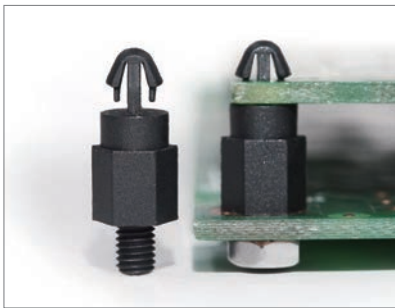

MOUNTING HOLE Ø3.0
THICKNESS 1.6

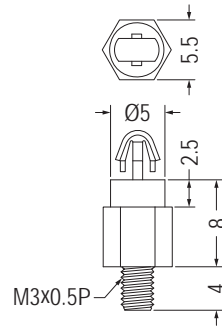

Part No.	Package
SCBD-8	1000

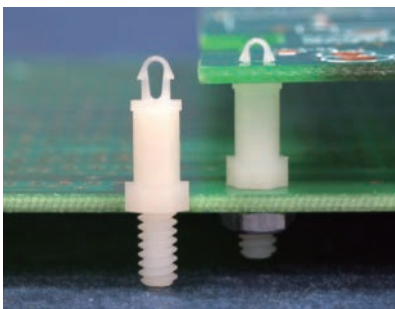

MOUNTING HOLE Ø2.5
THICKNESS 1.6

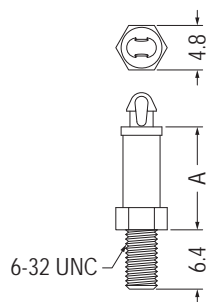

Part No.	A	Package
SCBS632-3.2	3.2	1000
SCBS632-4.8	4.8	
SCBS632-6.4	6.4	
SCBS632-7.9	7.9	
SCBS632-9.5	9.5	
SCBS632-11.1	11.1	
SCBS632-12.7	12.7	
SCBS632-14.3	14.3	
SCBS632-15.9	15.9	

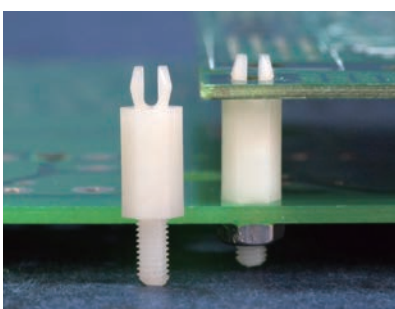

MOUNTING HOLE Ø3.0
THICKNESS 1.2

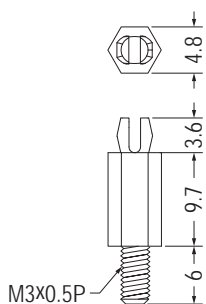

Part No.	Package
MSPA3-9.7	1000

PCB間隔柱 PCB SPACER

用途：PC板端直接壓入固定，另一端可配合螺母或攻牙。

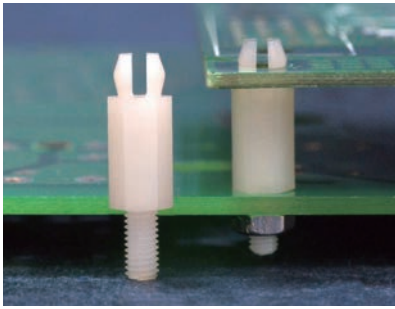

- Material: Nylon 66 (UL)
- Flame Class: 94V-2/94V-0
- Color: Natural/Black
- Unit: mm

MOUNTING HOLE $\varnothing 3.9\text{--}\varnothing 4.0$
THICKNESS 1.6

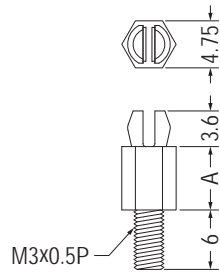

Part No.	A	Package
MSPG3-3.2	3.2	1000
MSPG3-4.8	4.8	
MSPG3-6.4	6.4	
MSPG3-9.5	9.5	
MSPG3-12.7	12.7	
MSPG3-15.9	15.9	
MSPG3-19.1	19.1	
MSPG3-22.2	22.2	

MOUNTING HOLE $\varnothing 3.9\text{--}\varnothing 4.0$
THICKNESS 1.6

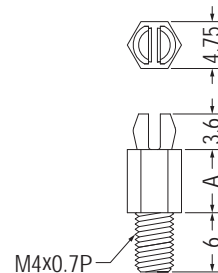

Part No.	A	Package
MSPG4-3.2	3.2	1000
MSPG4-4.8	4.8	
MSPG4-6.4	6.4	
MSPG4-9.5	9.5	
MSPG4-12.7	12.7	
MSPG4-15.9	15.9	
MSPG4-19.1	19.1	
MSPG4-22.2	22.2	

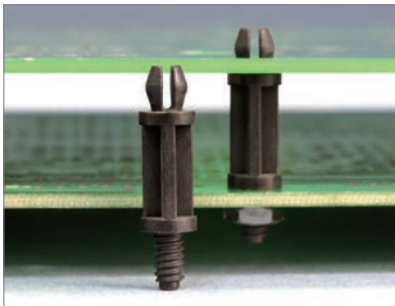

MOUNTING HOLE: $\varnothing G$ THICKNESS 2.1 MOUNTING HOLE: $\varnothing G$ THICKNESS 1.6

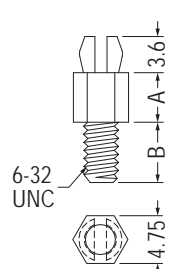
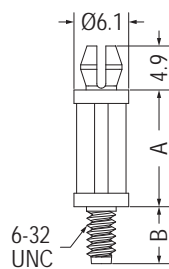

【 MSPS-13 】

Part No.	A	B	G	Package
MSPS-2S	2.0	3.0	4.0	2000
MSPS-3	3.2	6.0	4.0	
MSPS-5	4.8	6.0	3.9-4.0	1000
MSPS-6	6.4	6.0	3.9-4.0	
MSPS-12.7	12.7	6.0	3.9-4.0	
MSPS-13	13.0	6.35	4.0	
MSPS-15.9	15.9	6.0	3.9-4.0	
MSPS-19.1	19.1	6.0	3.9-4.0	
MSPS-22.2	22.2	6.0	3.9-4.0	

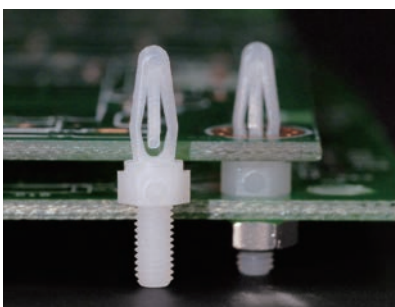

MOUNTING HOLE $\varnothing 3.2$
THICKNESS 1.6

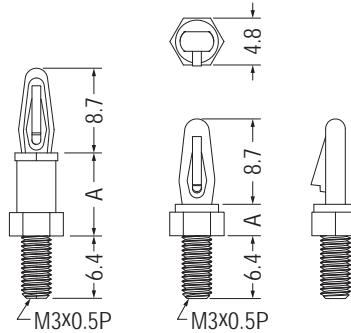

【 SCB3-12.7 】

Part No.	A	Package
SCB3-3.2	3.2	1000
SCB3-9.5	9.5	
SCB3-12.7	12.7	

MOUNTING HOLE $\varnothing 3.4$
THICKNESS 1.6

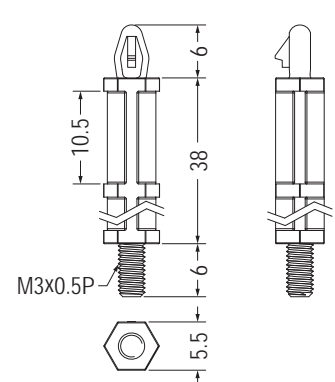

Part No.	Package
SCB3-38	1000

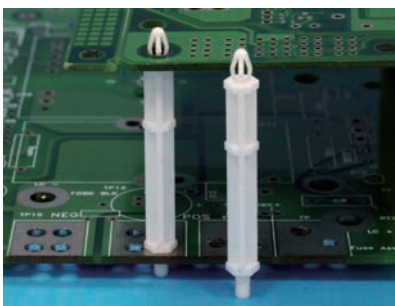

PCB間隔柱 PCB SPACER

用途：PC板端直接壓入固定，另一端可配合螺母或攻牙。

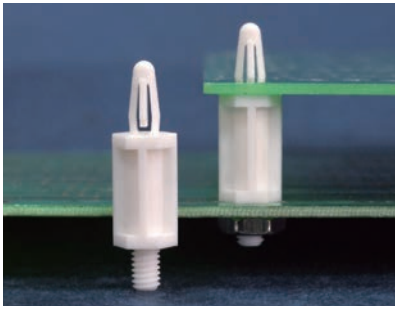

- Material: Nylon 66 (UL)
- Flame Class: 94V-2/94V-0
- Color: Natural/Black
- Unit: mm

MOUNTING HOLE Ø4.0
THICKNESS 1.6

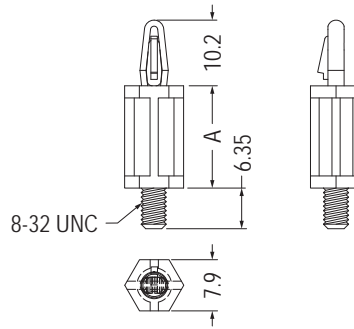

Part No.	A	Package
SCB832-6.35	6.35	1000
SCB832-12.7	12.7	
SCB832-15.9	15.9	
SCB832-19	19.05	

MOUNTING HOLE Ø4.0
THICKNESS 1.6

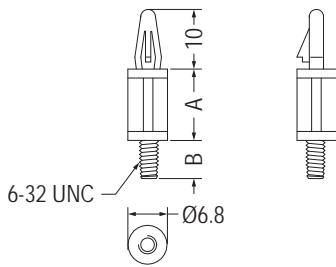

Part No.	A	B	Package
SCB-6	6.3	7.8	1000
SCB-10	9.5	7.8	
SCB-12	12.7	7.8	
SCB-15	15.9	7.8	
SCB-15A	15.9	4.8	

MOUNTING HOLE Ø4.0
THICKNESS 1.6

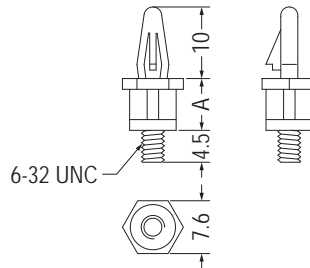

Part No.	A	Package
SCB-8.5S	8.5	1000
SCB-10SA	10.0	

MOUNTING HOLE Ø4.0
THICKNESS 1.2-1.7

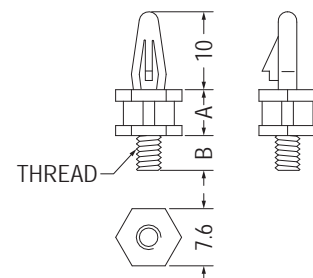

Part No.	A	B	Thread	Package
SCB-6SM3	6.3	4.8	M3x0.5P	1000
SCB-6S	6.3	4.8	6-32 UNC	
SCB-8S	8.0	4.5	6-32 UNC	
SCB-10S	10.0	4.5	6-32 UNC	

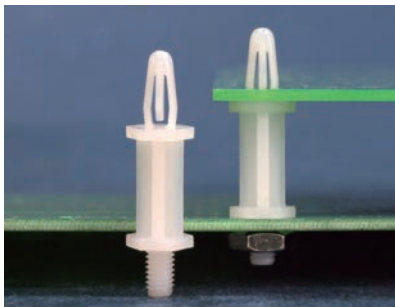

MOUNTING HOLE Ø4.0
THICKNESS: T

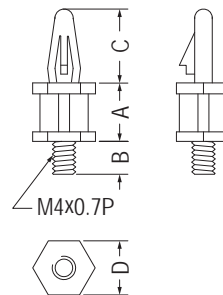

Part No.	A	B	C	D	T	Package
SCB4-6	6.3	4.8	10.7	7.6	1.2-1.7	1000
SCB4-6A	6.3	6.4	10.7	7.6	1.2-1.7	
SCB4-9.5	9.5	6.4	10.2	7.7	1.6	
★SCB4-14.3	14.3	6.4	10.2	7.7	1.6	
SCB4-16	15.9	6.4	10.0	8.0	1.6-1.8	

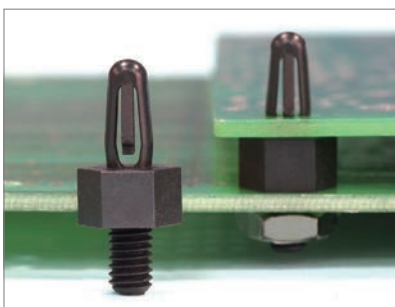

MOUNTING HOLE Ø4.0
THICKNESS: T

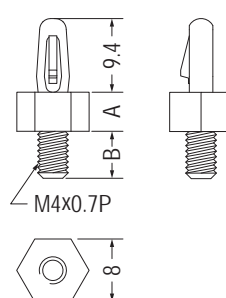

Part No.	A	B	T	Package
SCB4-4	4.0	6.4	2.0	1000
SCB4-5	5.0	6.0	1.6	

MOUNTING HOLE Ø4.0
THICKNESS 1.6

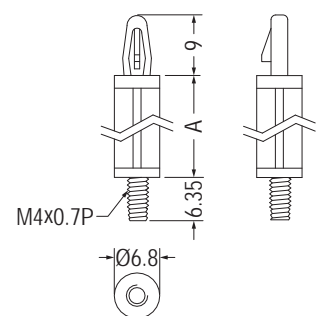

Part No.	A	Package
SCB4-23.8	23.8	1000
SCB4-30	30.0	

PCB間隔柱 PCB SPACER

用途：PC板端直接壓入固定，另一端可配合螺母或攻牙。

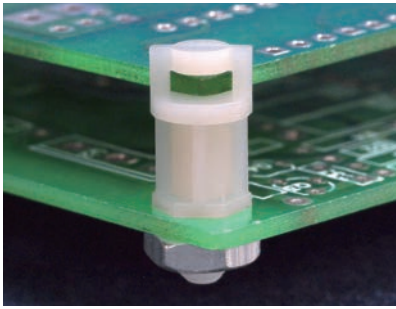

- Material: Nylon 66 (UL)
- Flame Class: 94V-2/94V-0
- Color: Natural/Black
- Unit: mm

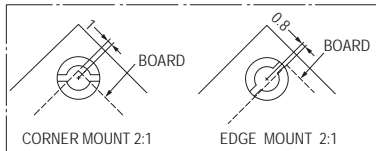
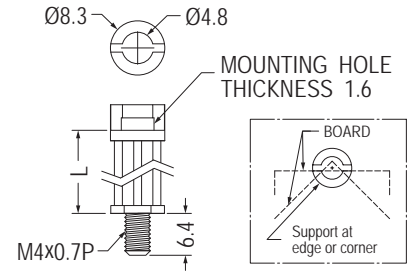
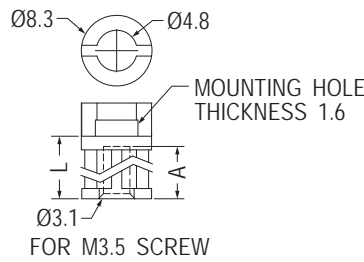

Part No.	A	L	Package
TCEH-6.4	5.2	6.4	1000
TCEH-9.5	7.9	9.5	
TCEH-12.7	7.9	12.7	
TCEH-15.9	7.9	15.9	

Part No.	L	Package
TCEP4-6.4	6.4	1000
TCEP4-9.5	9.5	
TCEP4-12.7	12.7	
TCEP4-15.9	15.9	

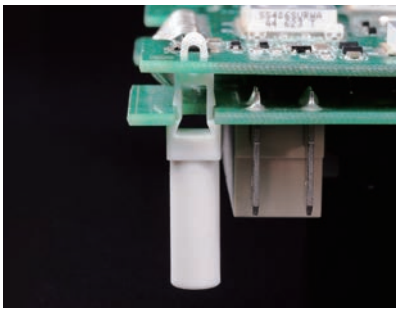

- Material: PBT (UL)+GF
- Flame Class: 94V-0
- Color: Natural
- Unit: mm

用途：用於PC板之間隔柱。

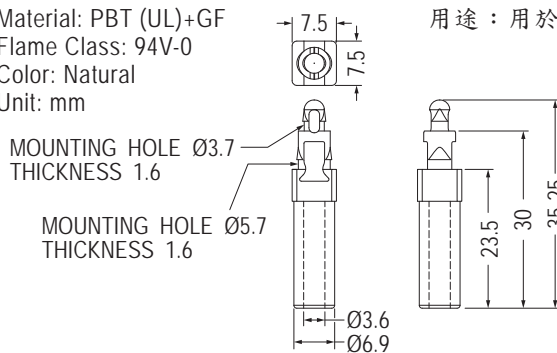

Part No.	Package
THCS-2	1000

觸控間隔柱 TOUCH CONTROL SPACER

用途：固定觸控面板於機板上，具減震效果。

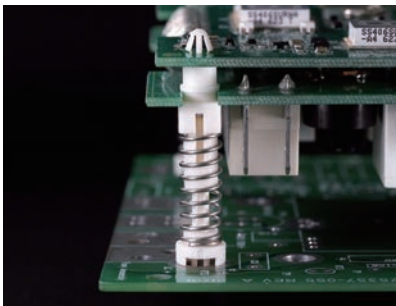

- Material: Nylon 66 (UL)
- Flame Class: 94V-0
- Spring Material: SUS
- Color: Natural
- Unit: mm
- Patented (專利品)

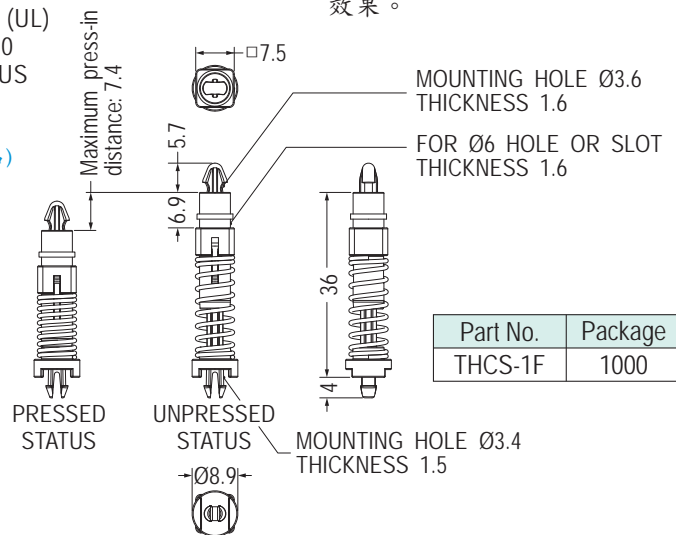

Part No.	Package
THCS-1F	1000

PCB導電間隔柱 PCB CONDUCTIVE SPACER

用途：支撐PC板與機板間之導電。

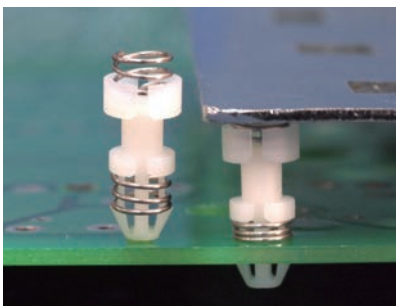

- Material: Nylon 66 (UL)
- Flame Class: 94V-2/94V-0
- Color: Natural/Black
- Unit: mm
- USA Patented (美國專利品)

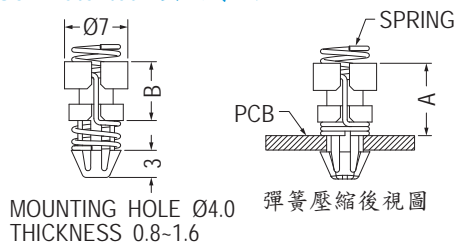

Part No.	A	B	Package
ALUCA-8	8.0	6.5	1000
ALUCA-9	9.0	7.5	
ALUCA-10	10.0	8.5	
ALUCA-12	12.0	10.5	
ALUCA-14	14.0	12.5	
ALUCA-16	16.0	14.5	

導光板間隔柱 PILLAR SUPPORT

用途：用於支撐液晶面板，高導光，高反射，高透光。

- Material: PC (UL)
- Flame Class: 94V-2/94V-0
- Color: Natural/Transparent
- Unit: mm

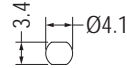
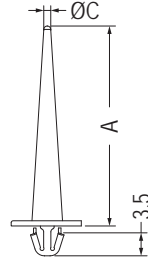
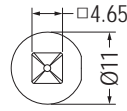
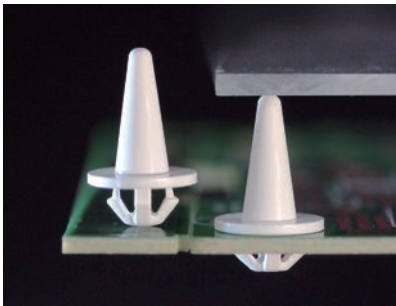
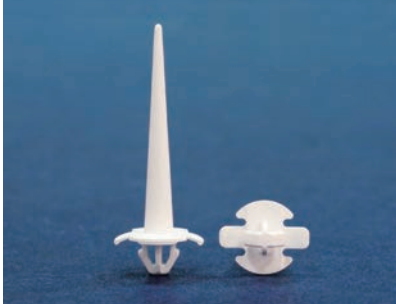
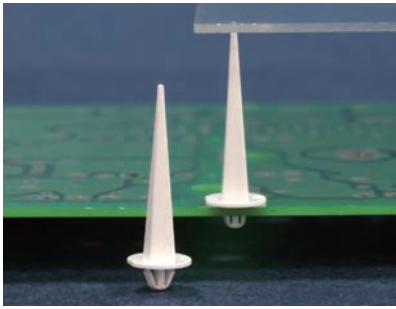

MOUNTING HOLE THICKNESS: T

Part No.	A	C	T	Package
MCFG-3010	30.5	0.8	1.0	1000
MCFG-35810	35.8	1.05	1.05	

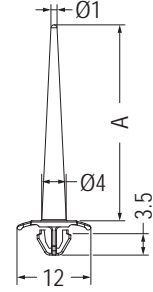
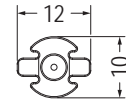

MOUNTING HOLE Ø4.5 THICKNESS 0.8-1.0

Part No.	A	Package
MCFD-2810	28.0	1000
MCFD-3210	32.0	

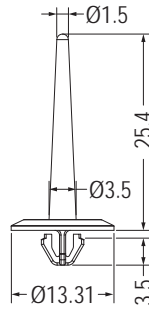

MOUNTING HOLE Ø4.5 THICKNESS: T

Part No.	T	Package
MCFA-2508	0.6-0.8	500
MCFA-2511	0.8-1.1	

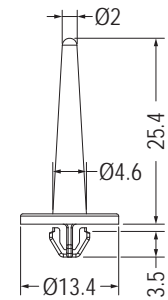

MOUNTING HOLE Ø4.5 THICKNESS 0.6-0.8

Part No.	Package
MCFC-2508	1000

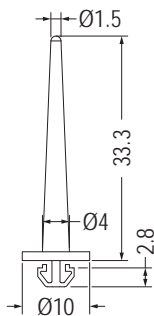

MOUNTING HOLE Ø4.5 THICKNESS 1.0

Part No.	Package
MCFL-3310	1000

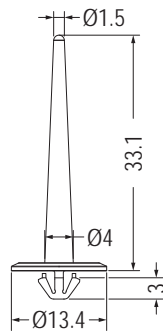

MOUNTING HOLE Ø4.6 THICKNESS: T

Part No.	T	Package
MCF-3305	0.6	500
MCF-3308	0.5-0.8	

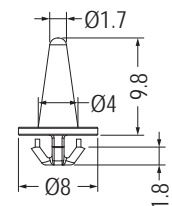

MOUNTING HOLE Ø4.6 THICKNESS 1.0

Part No.	Package
MCFF-25	1000

導光板間隔柱 PILLAR SUPPORT

用途：用於支撐液晶面板，高導光，高反射，高透光。

- Material: PC (UL)
- Flame Class: 94V-2/94V-0
- Color: Natural/Transparent
- Unit: mm

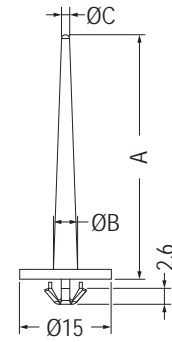
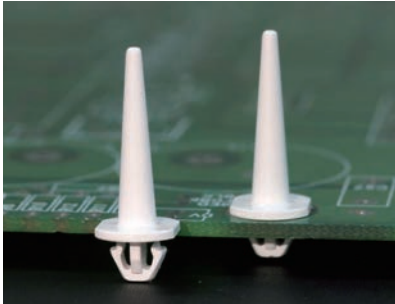
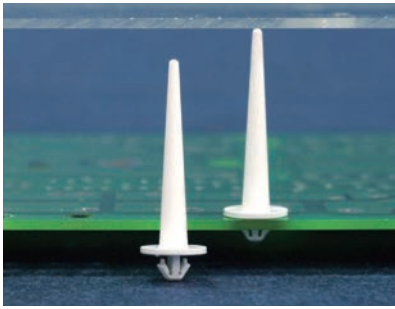

MOUNTING HOLE Ø5.2
THICKNESS: T

Part No.	A	B	C	T	Package
MCF-2310	23.5	4.5	1.6	0.8-1.0	500
MCF-4213	40.0	3.95	1.3	1.0-1.3	



MOUNTING HOLE Ø3.8
THICKNESS: T

Part No.	A	T	Package
MCFO-2806	28.5	0.5-0.65	1000
MCFO-2906	29.5	0.5-0.65	
MCFO-2908	29.5	0.6-0.8	

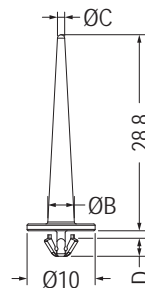

MOUNTING HOLE: ØG
THICKNESS: T

Part No.	B	C	D	G	T	Package
MCFJ-4	3.9	1.06	2.65	3.8	1.0	1000
MCFJ-6	4.3	1.5	2.65	3.8	1.25	
MCFJ-7	3.9	1.06	2.5	3.5	0.8	

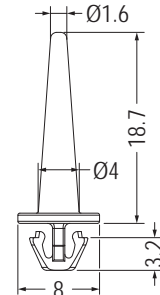

MOUNTING HOLE Ø4.6
THICKNESS 1.3

Part No.	Package
MCFF-20	1000

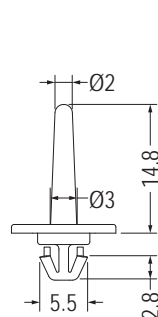
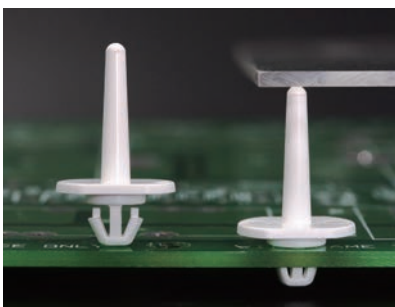

MOUNTING HOLE Ø4.5
THICKNESS 1.2

Part No.	Package
MCFF-18	1000

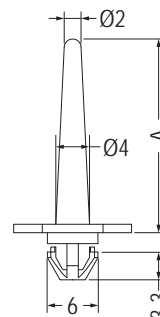

MOUNTING HOLE Ø5.5
THICKNESS 0.8

Part No.	A	Package
MCFF-21	23.0	1000
★MCFF-21L	24.0	

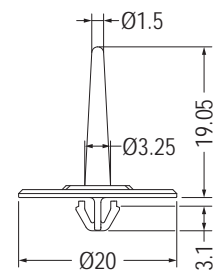

MOUNTING HOLE Ø4.7
THICKNESS 1.0

Part No.	Package
MCFF-11	1000

導光板間隔柱 PILLAR SUPPORT

用途：用於支撐液晶面板，高導光，高反射，高透光。

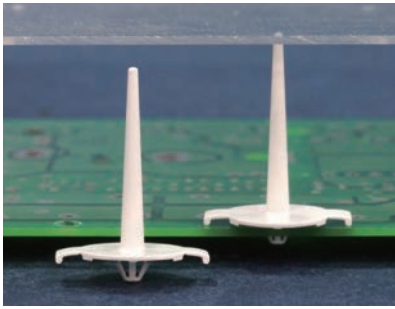

- Material: PC (UL)
- Flame Class: 94V-0
- Color: Natural
- Unit: mm

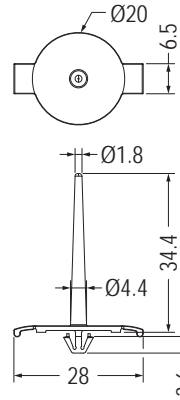

MOUNTING HOLE Ø5.0
THICKNESS 0.75-1.05

Part No.	Package
MCFD-1	500

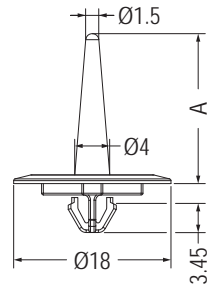
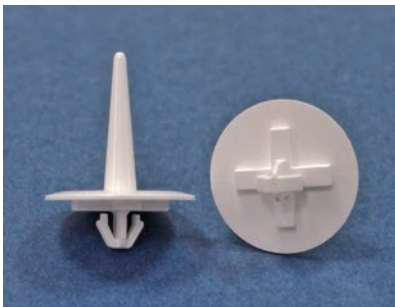

MOUNTING HOLE Ø4.6
THICKNESS: T

Part No.	A	T	Package
MCFF-9	17.16	0.6-0.8	1000
MCFF-10	31.42	0.8	500
MCFF-14	18.0	0.8	1000



- Material: Nylon 66 (UL)
- Flame Class: 94V-0
- Color: White
- Unit: mm

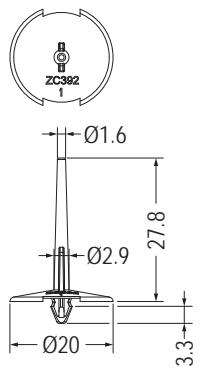

MOUNTING HOLE Ø3.0
THICKNESS 0.65

Part No.	Package
MCFM-2807	1000

- Material: PC (UL)
- Flame Class: 94V-2/94V-0
- Color: Transparent
- Unit: mm

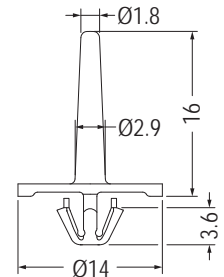

MOUNTING HOLE Ø5.0
THICKNESS 1.0

Part No.	Package
MCFF-24	1000

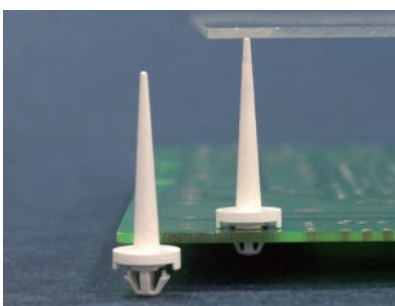

- Material: PC (UL)
- Flame Class: 94V-2/94V-0
- Color: Natural/Transparent
- Unit: mm

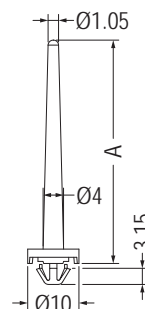

MOUNTING HOLE Ø5.2
THICKNESS 0.6-0.8

Part No.	A	Package
MCF-428	42.6	500
MCF-2908	29.0	

導光板間隔柱 PILLAR SUPPORT

用途：用於支撐液晶面板，高導光，高反射，高透光。

1

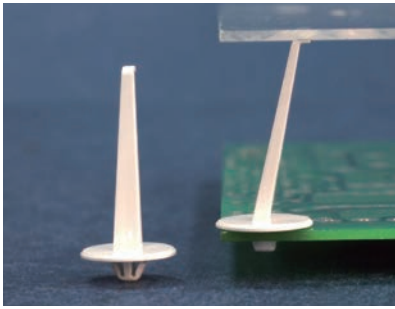

- Material: PC (UL)
- Flame Class: 94V-2/94V-0
- Color: Natural/Transparent
- Unit: mm

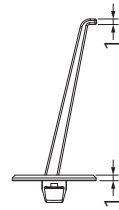
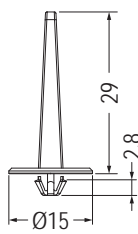

MOUNTING HOLE Ø4.5
THICKNESS 0.8-1.0

Part No.	Package
MCF-1	1000

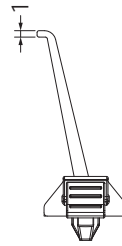
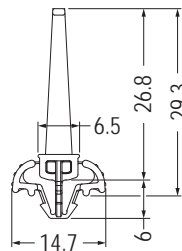
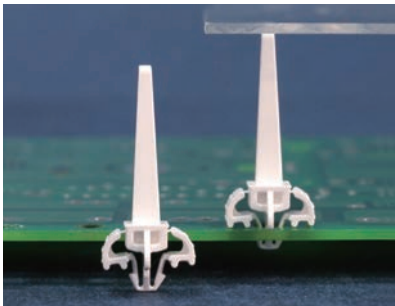

MOUNTING HOLE Ø4.5
THICKNESS 1.0

• Patented (專利品)

Part No.	Package
MCFF-5	1000

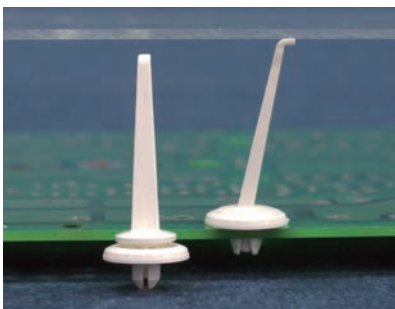

- Material: PC (UL)
- Flame Class: 94V-0
- Color: Natural
- Unit: mm
- Patented (專利品)

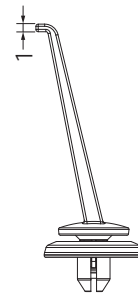
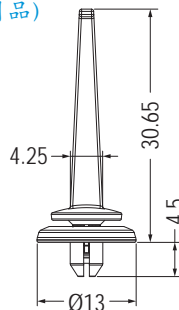

MOUNTING HOLE Ø4.5
THICKNESS 1.0-1.2

Part No.	Package
MCFF-6	500

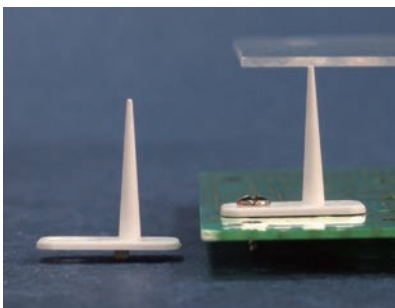

- Material: PC (UL)
- Flame Class: 94V-0
- Color: White
- Unit: mm

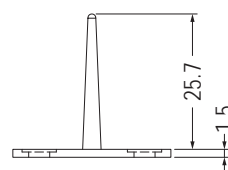
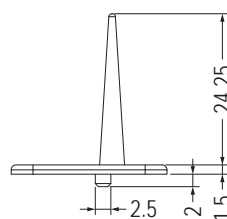
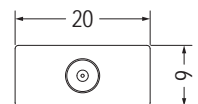
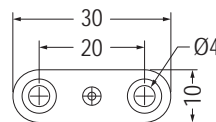
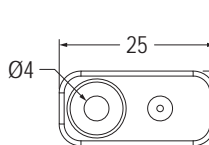

MOUNTING HOLE Ø5.0
THICKNESS 0.6-0.8

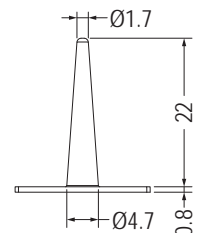

Part No.	Package
MCFJ-1	1000

Part No.	Package
MCFJ-2	1000

Part No.	Package
MCFP-33	1000

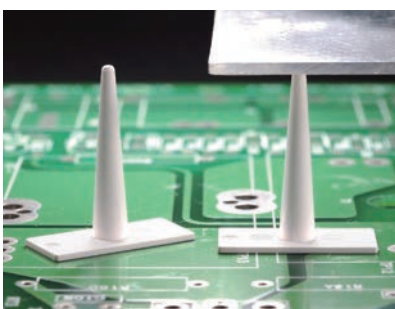

導光板間隔柱 PILLAR SUPPORT

用途：用於支撐液晶面板，高導光，高反射，高透光。

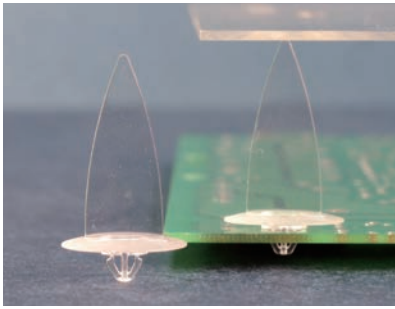

- Material: PC (UL)
- Flame Class: 94V-2/94V-0
- Color: Transparent
- Unit: mm

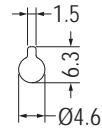
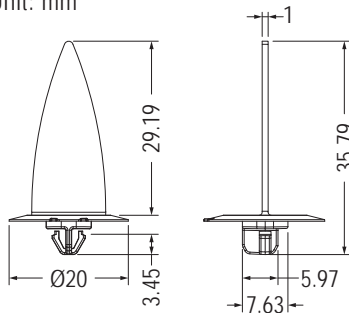

MOUNTING HOLE THICKNESS 0.8

Part No.	Package
MCFF-15	1000

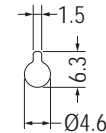
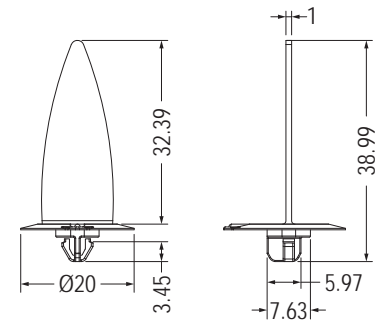

MOUNTING HOLE THICKNESS 0.8

Part No.	Package
MCFF-16	1000

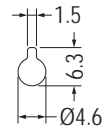
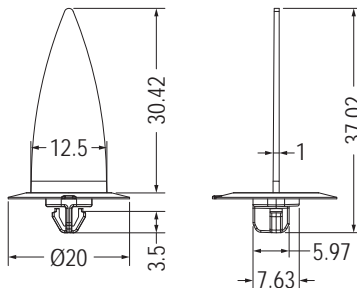
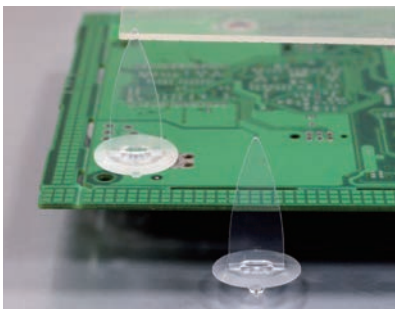

MOUNTING HOLE THICKNESS 0.8

Part No.	Package
MCFF-13	1000

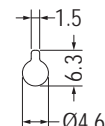
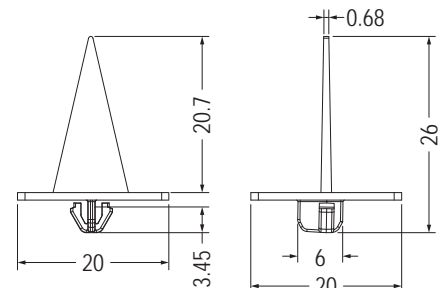

MOUNTING HOLE THICKNESS 0.8

Part No.	Package
MCFF-17	1000



- Material: PC (UL)/94V-0
- Color: Transparent
- Base Material: Nylon 66 (UL)/94V-0
- Base Color: Natural
- Unit: mm
- Patented (專利品)

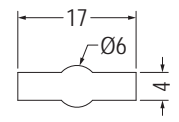
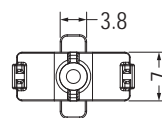

MOUNTING HOLE THICKNESS 0.5-1.0

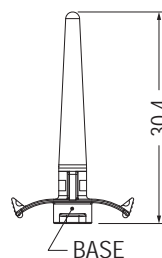

Part No.	Package
MCFF-7	1000

導光板間隔柱 PILLAR SUPPORT

用途：用於支撐液晶面板，高導光，高反射，高透光。

1

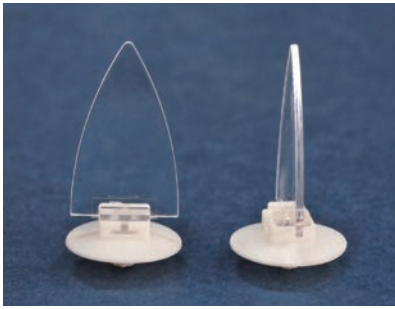

- Material1: PC (UL)
- Material2: Nylon 66 (UL)
- Flame Class: 94V-2/94V-0
- Color1: Transparent
- Color2: Natural/White
- Unit: mm
- Patented (專利品)

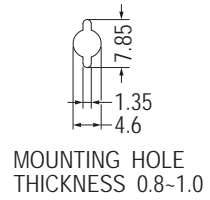
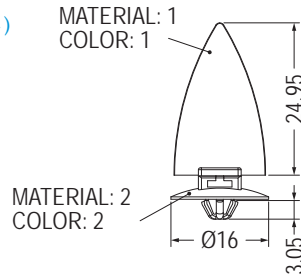

Part No.	Package
MCFF-12	1000

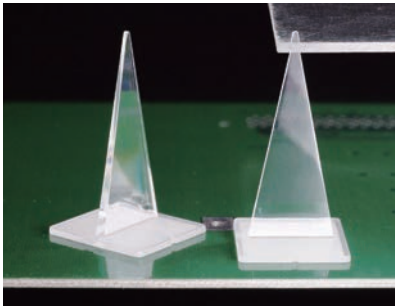

- Material: PC (UL)
- Flame Class: 94V-2/94V-0
- Color: Transparent
- Unit: mm

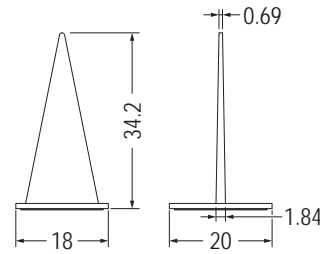

WHITE REFLECTING SHEET

Part No.	Package
MCFP-30	1000

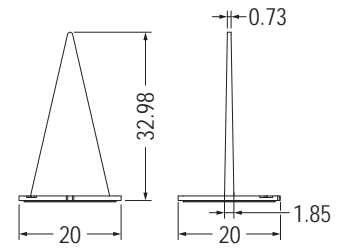

DOUBLE ADHESIVE TAPE

Part No.	Package
MCFP-17-1	1000

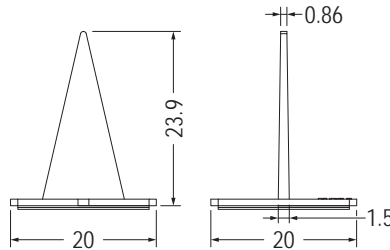
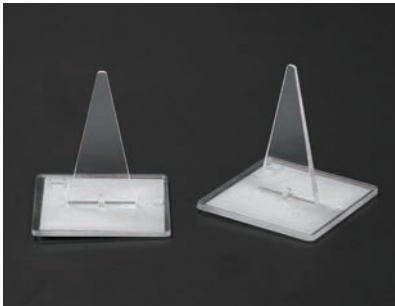

WHITE REFLECTING SHEET

Part No.	Package
★MCFP-35	1000

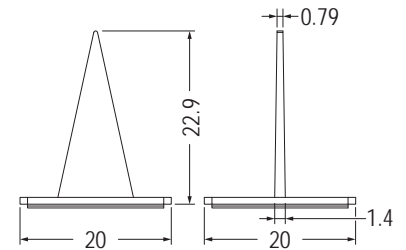

WHITE REFLECTING SHEET

Part No.	Package
★MCFP-34	1000

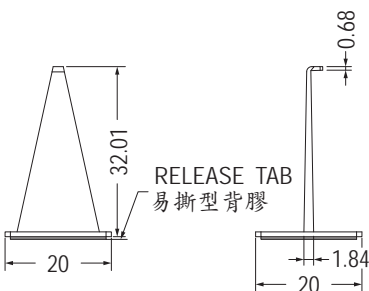
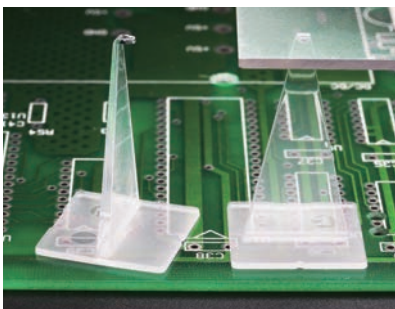

WHITE REFLECTING SHEET

Part No.	Package
★MCFP-36	500

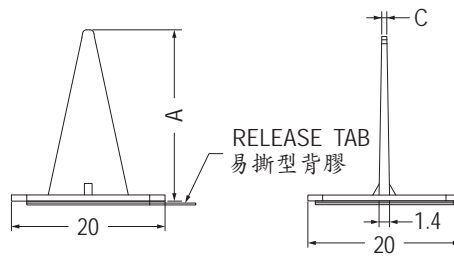

DOUBLE ADHESIVE TAPE

Part No.	A	C	Package
MCFP-12	20.7	0.71	1000
MCFP-25	22.3	0.68	

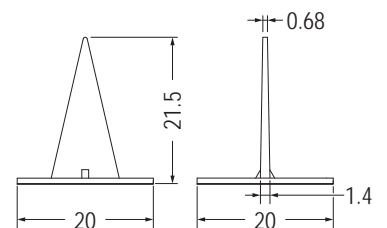

DOUBLE ADHESIVE TAPE

Part No.	Package
MCFP-5	1000

導光板間隔柱 PILLAR SUPPORT

用途：用於支撐液晶面板，高導光，高反射，高透光。

- Material: PC (UL)
- Flame Class: 94V-2/94V-0
- Color: Transparent
- Unit: mm

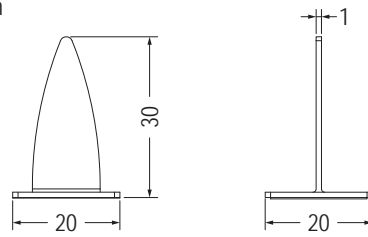
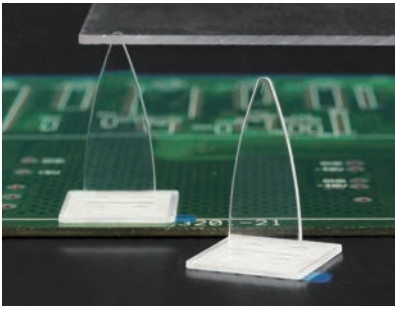

DOUBLE ADHESIVE TAPE

Part No.	Package
MCFP-7	1000

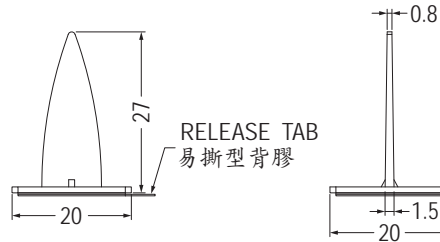
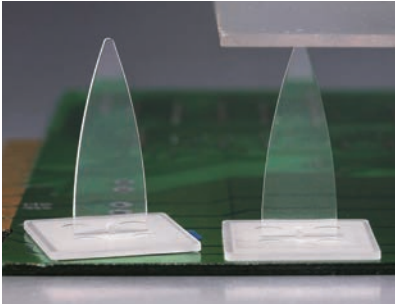

DOUBLE ADHESIVE TAPE

Part No.	Package
MCFP-18	1000

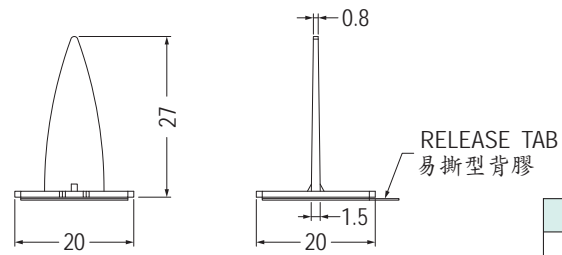
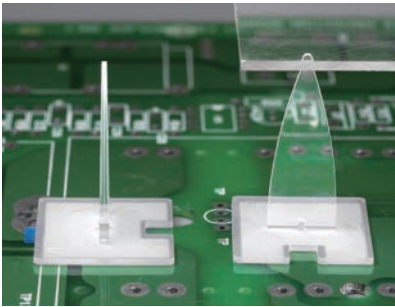

DOUBLE ADHESIVE TAPE

Part No.	Package
MCFP-29	1000

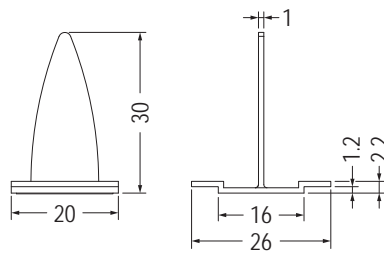
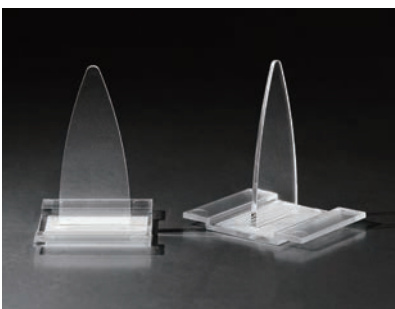

WHITE REFLECTION SHEET

Part No.	Package
MCFP-9	1000

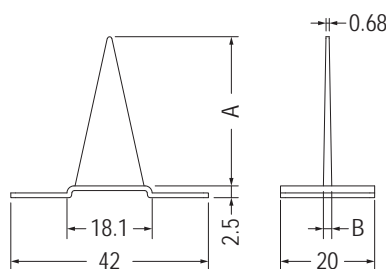
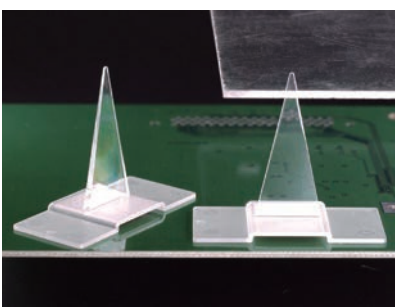

Part No.	A	B	Package
MCFP-31	31.7	1.78	500
MCFP-32	32.0	1.8	

M.2間隔柱 M.2 SSD SPACER

用途：適用於NGFF卡於機板上，免工具，易拆卸。

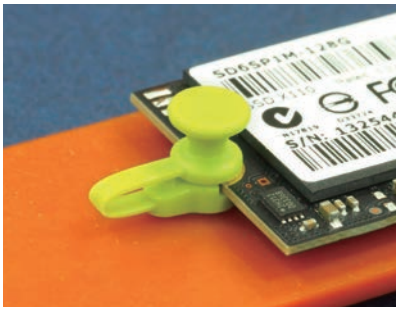

- Material: Nylon 66 (UL)
- Flame Class: 94V-2/94V-0
- Color: Natural/Black/Green/Blue
- Unit: mm

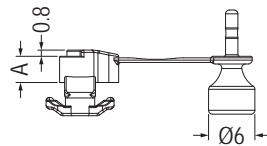

【 ULCN3.4-2.1 】

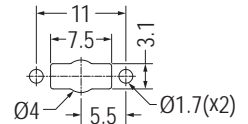
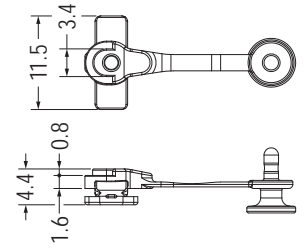

MOUNTING HOLE THICKNESS 0.6

- Flame Class: 94V-2
- Color: Green

Part No.	Package
ULCN-3	1000

Part No.	A	T	Package
ULCN-1	1.7	2.1-2.4	1000
ULCN1.7-2.4	1.7	2.1-2.4	
ULCN2.2-1.2	2.2	1.2	
ULCN2.5-1.6	2.5	0.8-1.6	
ULCN2.5-2.6	2.5	1.8-2.6	
ULCN2.5-2.9	2.5	2.1-2.9	
ULCN3.4-0.8	3.4	0.8	
ULCN3.4-2.1	3.4	2.13	
ULCN6.3-1.6	6.3	1.6	

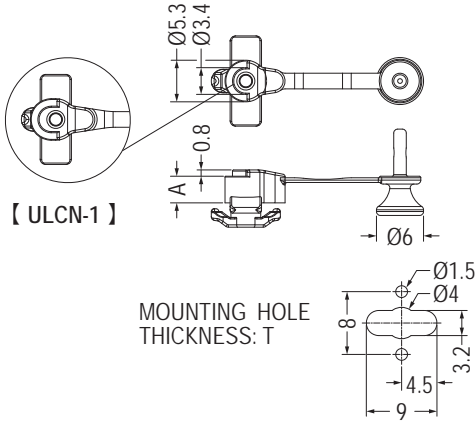

- Material: Nylon 66 (UL)
- Flame Class: 94V-2/94V-0
- Color: Natural/Black/Green/Blue
- Unit: mm
- Patented (專利品)

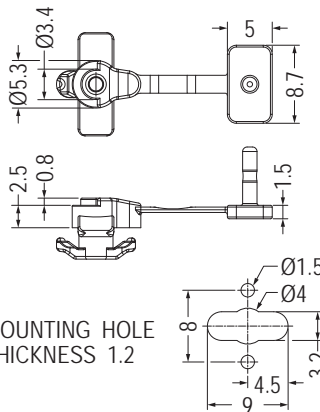

Part No.	Package
ULCN2.5-1.2	1000

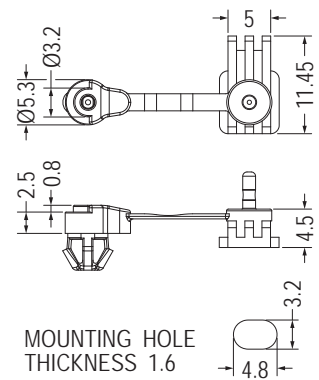

Part No.	Package
ULCW2.5-1.6	1000

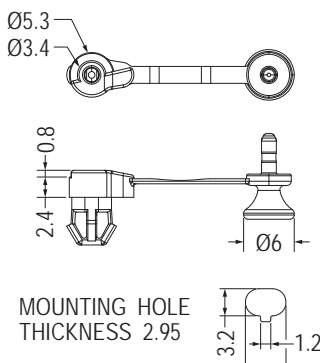

Part No.	Package
ULCO2.4A-3.1	1000

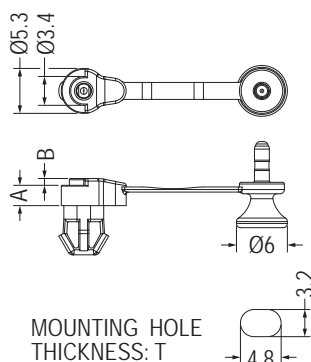

Part No.	A	B	T	Package
ULCO2.1-2	2.08	0.81	2.0	1000
ULCO2.4-2.1	2.4	0.8	2.1	
ULCO2.4-3.1	2.4	0.8	2.95	
ULCO2.5-1.6	2.5	0.8	1.6	
ULCO2.5-2.2	2.5	0.8	2.2	
ULCO2.5-2.4	2.5	0.8	2.4	
ULCO2.5-4.2	2.5	0.8	4.2	
ULCO6.6-2.6	6.6	0.8	2.46	

M.2間隔柱 M.2 SSD SPACER

用途：適用於NGFF卡於機板上，免工具，易拆卸。



- Material: Nylon 66 (UL)
- Flame Class: 94V-2/94V-0
- Color: Natural/Black/Green/Blue
- Unit: mm
- Patented (專利品)

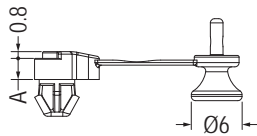
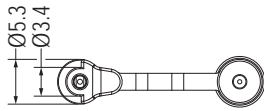

MOUNTING HOLE THICKNESS 1.6 Ø4.3

Part No.	A	Package
ULCOG2.5-1.6	2.5	1000
ULCOG6.3-1.6	6.3	

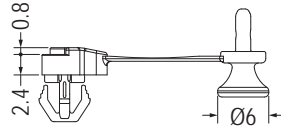
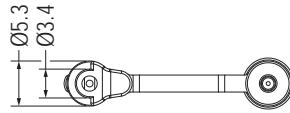

MOUNTING HOLE THICKNESS 1.6-2.1 3.2

Part No.	Package
ULCOJ-1	1000

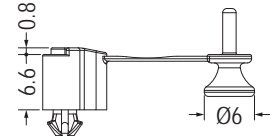
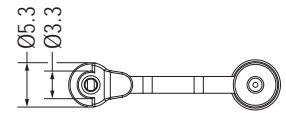

MOUNTING HOLE Ø3.0 THICKNESS: T

Part No.	T	Package
ULCN6.6-1.2	1.2	1000
ULCN6.6-1.6	1.5-1.6	

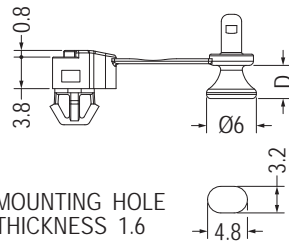
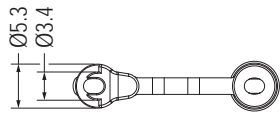

MOUNTING HOLE THICKNESS 1.6 3.2

Part No.	D	Package
ULCO3.8-1.6S	2.5	1000
ULCO3.8-1.6	4.0	

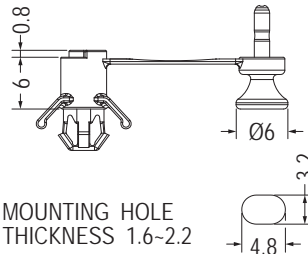
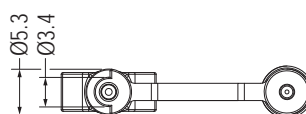

MOUNTING HOLE THICKNESS 1.6-2.2 3.2

Part No.	Package
ULCOB-1	1000

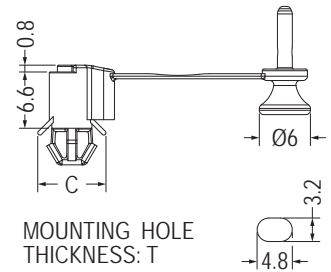
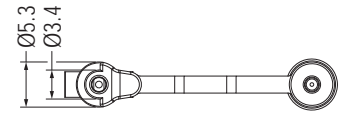

MOUNTING HOLE THICKNESS: T 3.2

Part No.	C	T	Package
ULCO6.6-1.6	8.0	1.6	1000
ULCO6.6-2	8.0	1.9-2.1	
ULCO6.6-3.1	8.3	2.7-3.3	

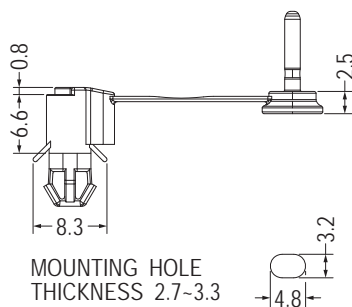
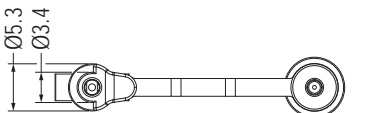

MOUNTING HOLE THICKNESS 2.7-3.3 3.2

Part No.	Package
ULCO6.6-3.1S	1000

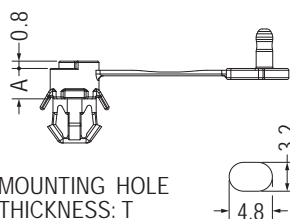
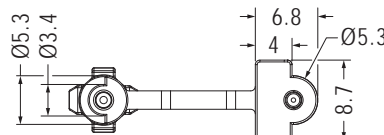

MOUNTING HOLE THICKNESS: T 3.2

Part No.	A	T	Package
ULCOB3.3-2.3	3.3	2.27	1000
ULCOB6-1.6	6.0	1.6	
ULCOB6-2.3	6.0	2.27	

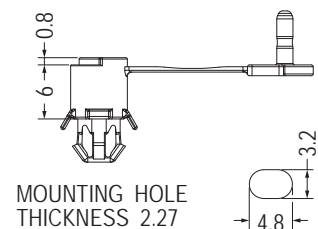
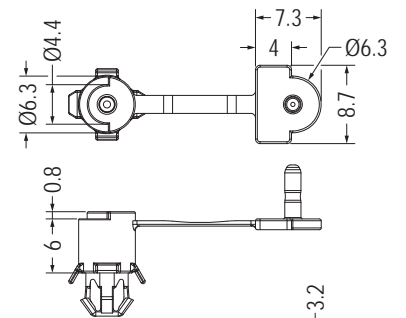

MOUNTING HOLE THICKNESS 2.27 3.2

Part No.	Package
ULCOB-2	1000

M.2間隔柱 M.2 SSD SPACER

用途：適用於NGFF卡於機板上，免工具，易拆卸。

- Material: Nylon 66 (UL)
- Flame Class: 94V-2/94V-0
- Color: Natural/Black/Green/Blue
- Unit: mm
- Patented (專利品)

- Material: Nylon 66 (UL)
- Flame Class: 94V-2/94V-0
- Color: Black
- Unit: mm

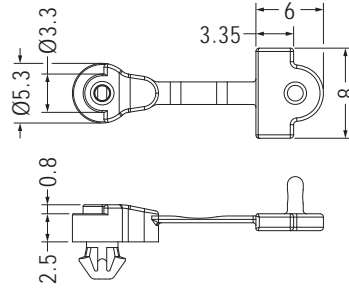
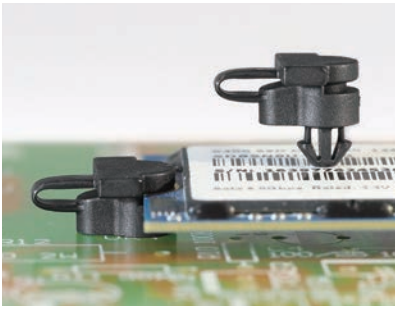

MOUNTING HOLE Ø3.0
THICKNESS 1.2

Part No.	Package
ULCNF2.5-1.2	1000

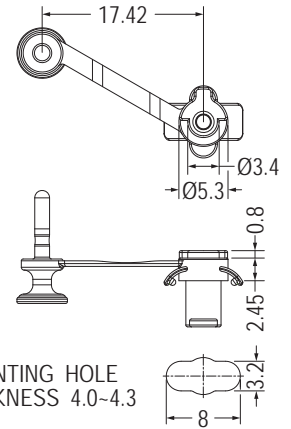

MOUNTING HOLE
THICKNESS 4.0-4.3

Part No.	Package
ULCNA2.5-4.3	1000

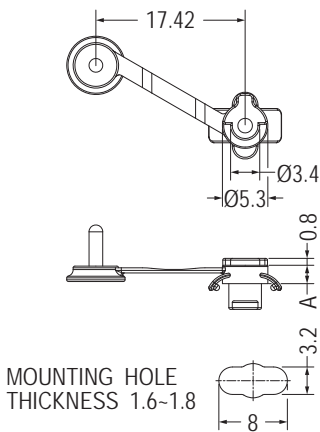

MOUNTING HOLE
THICKNESS 1.6-1.8

Part No.	A	Package
ULCNA2.5-1.8	2.15	1000
ULCNA2.5-1.8S	2.45	
ULCNA4-1.8	4.0	

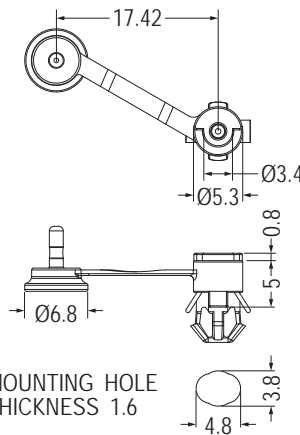

MOUNTING HOLE
THICKNESS 1.6

Part No.	Package
ULCOA5-1.6A	1000

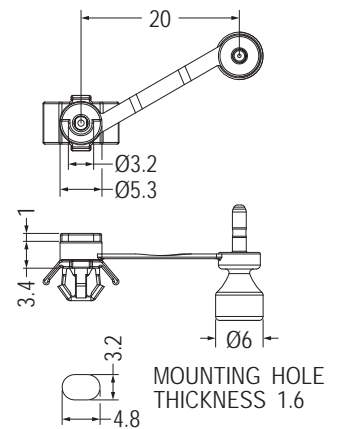

MOUNTING HOLE
THICKNESS 1.6

Part No.	Package
ULCOB3.4-1.6	1000

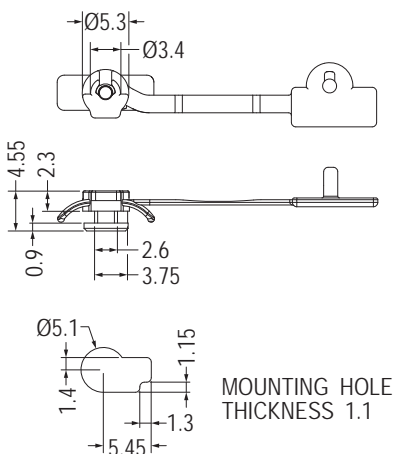

MOUNTING HOLE
THICKNESS 1.1

Part No.	Package
ULCND1.5-1.1	1000

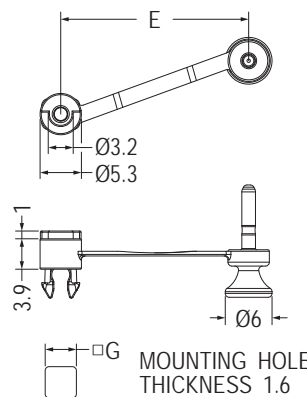

MOUNTING HOLE
THICKNESS 1.6

Part No.	E	G	Package
ULCY-1	18.27	4.05	1000
ULCY3.9-1.6	24.1	4.0	

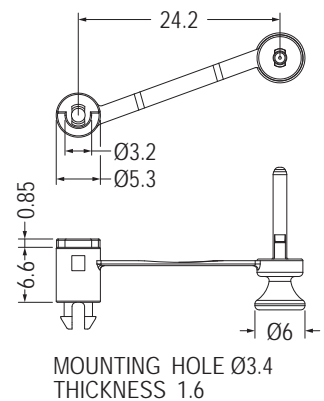

MOUNTING HOLE Ø3.4
THICKNESS 1.6

- Color: Black

Part No.	Package
ULCY-2	1000

M.2間隔柱 M.2 SSD SPACER

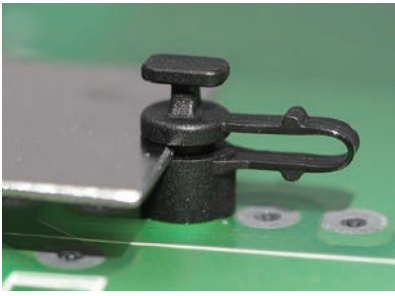

- Material: Nylon 66 (UL)
- Flame Class: 94V-2/94V-0
- Color: Natural/Black/Green/Blue
- Unit: mm
- Patented (專利品)

用途：適用NGFF卡於機板上，免工具，易拆卸。

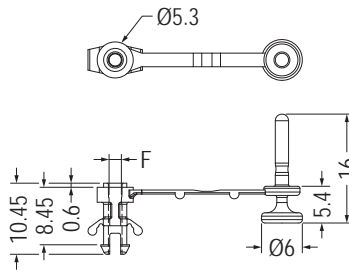

MOUNTING HOLE Ø3.5
THICKNESS 1.6-2.2

Part No.	F	Package
ULCOC-1	1.8	1000
ULCOC-9	1.77	

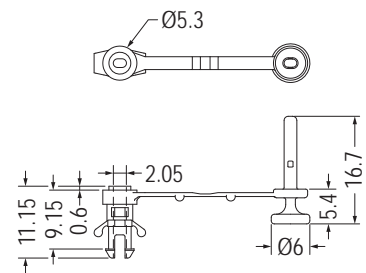

MOUNTING HOLE Ø3.5
THICKNESS 2.3-2.9

Part No.	Package
ULCOC-7L	1000

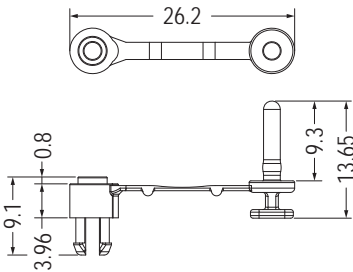

MOUNTING HOLE Ø4.0
THICKNESS 2.69

Part No.	Package
ULCOC-14	1000

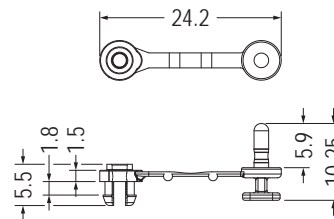

MOUNTING HOLE Ø4.0
THICKNESS 1.6

Part No.	Package
ULCOC-2	1000

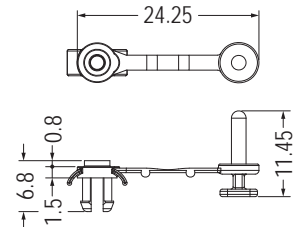

MOUNTING HOLE Ø4.0
THICKNESS 2.3-2.9

Part No.	Package
ULCOC-2L	1000

M.2導電間隔柱 M.2 SSD CONDUCTIVE SPACER

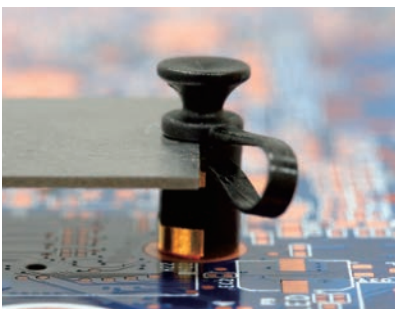

- Material: Nylon 66 (UL)
- Nut Material: Brass
- Flame Class: 94V-2/94V-0
- Color: Natural/Black
- Unit: mm
- Patented (專利品)

用途：適用NGFF卡於機板上，免工具，易拆卸，銅柱導電性佳，防E.M.I干擾。

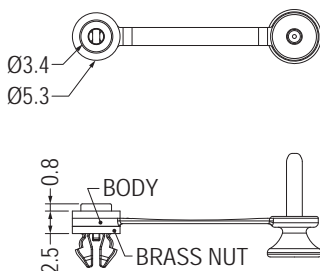

Part No.	Package
ULCOE-3ST	1000

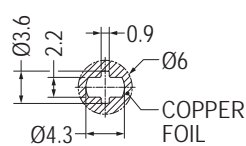

MOUNTING HOLE
THICKNESS 1.6

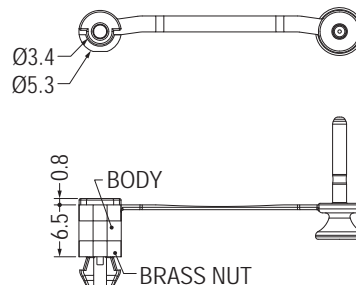

Part No.	Package
ULCOE-4ST	1000

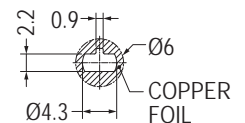

MOUNTING HOLE
THICKNESS 1.6

M.2間隔柱 M.2 SSD SPACER

用途：適用NGFF卡於機板上，免工具，易拆卸。

1

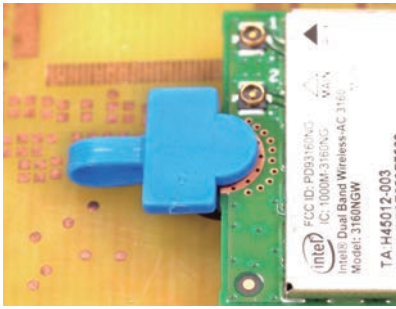

- Material: Nylon 66 (UL)
- Flame Class: 94V-2/94V-0
- Color: Natural/Black/Green/Blue
- Unit: mm
- Patented (專利品)

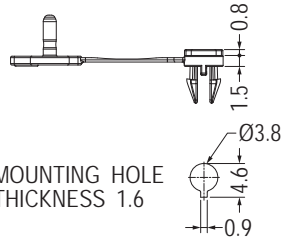
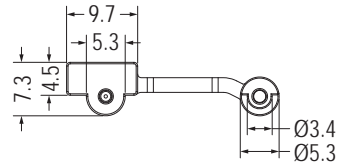

MOUNTING HOLE THICKNESS 1.6

Part No.	Package
ULCOD1.5-1.6	1000

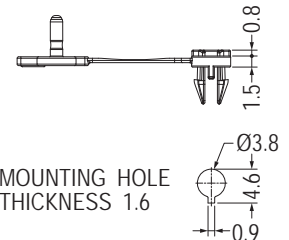
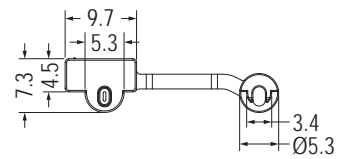

MOUNTING HOLE THICKNESS 1.6

Part No.	Package
ULCOD-1	1000

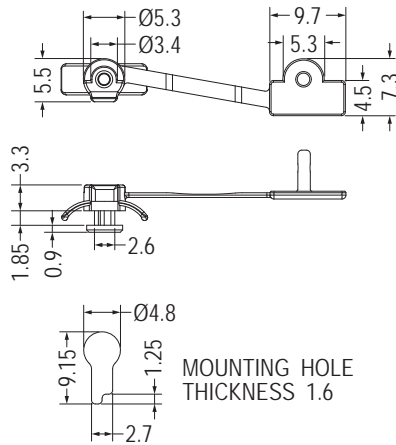
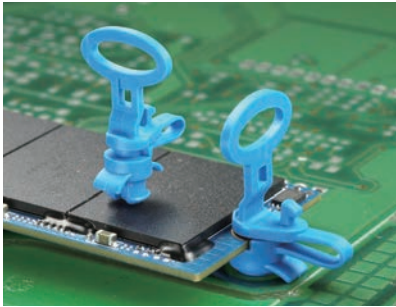
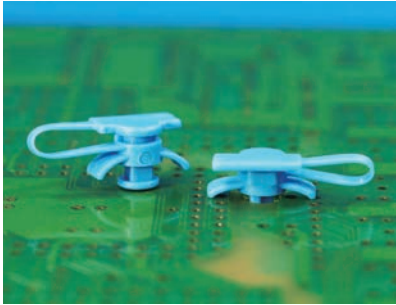

Part No.	Package
ULCND2.5-1.6	1000

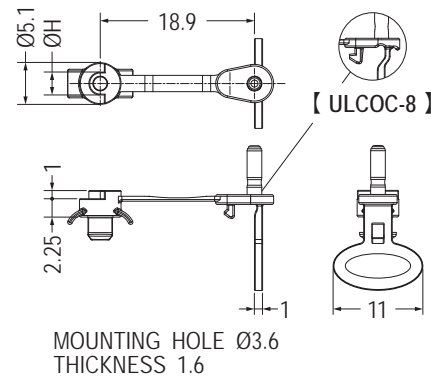

Part No.	H	Package
ULCOC-4	3.4	1000
ULCOC-8	2.8	



- Material: Nylon 66 (UL)
- Flame Class: 94V-2/94V-0
- Color: Natural/Black/Blue
- Unit: mm
- Patented (專利品)

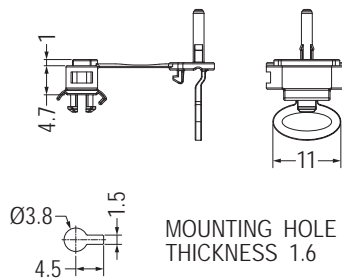
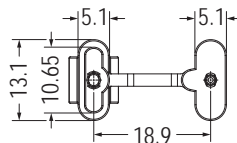

Part No.	Package
ULCOC-12	1000

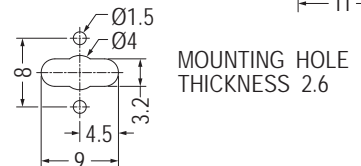
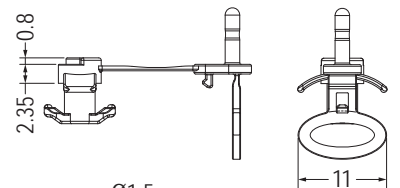
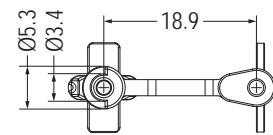

Part No.	Package
ULCOC2.4-2.6	1000

M.2間隔柱 M.2 SSD SPACER

用途：適用NGFF卡於機板上，免工具，易拆卸。

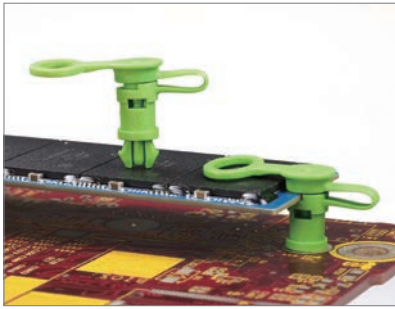

- Material: Nylon 66 (UL)
- Flame Class: 94V-2/94V-0
- Color: Green
- Unit: mm
- Patented (專利品)

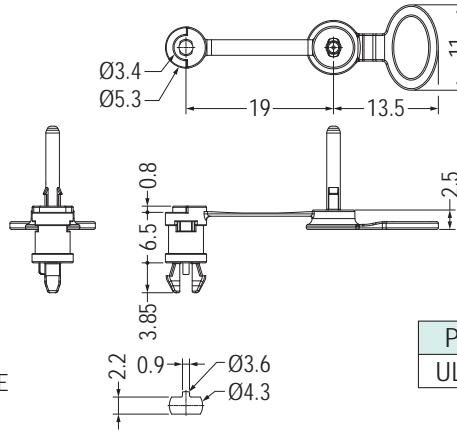

MOUNTING HOLE THICKNESS 1.6

Part No.	Package
ULCOM-1	1000

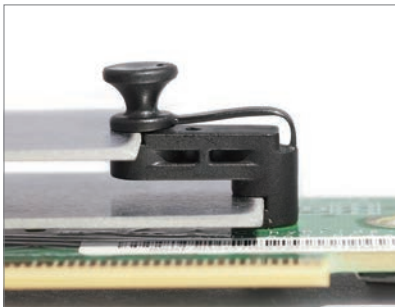

- Material: Nylon 66 (UL)
- Flame Class: 94V-2/94V-0
- Color: Black
- Unit: mm
- Patented (專利品)

用途：用於上下雙層NGFF卡之固定。

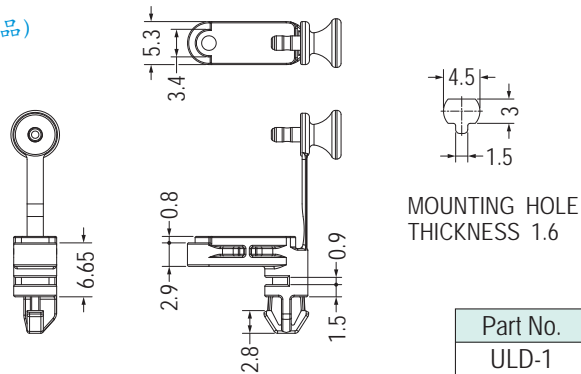

MOUNTING HOLE THICKNESS 1.6

Part No.	Package
ULD-1	1000



使用說明
Installation Guide

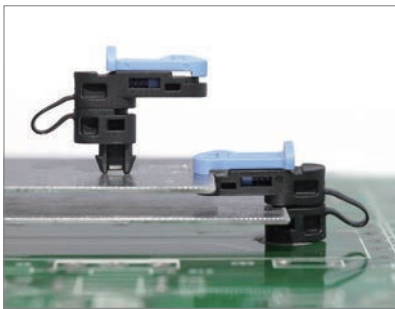

- Latch Base Material: Nylon 66 (UL)
- Latch Handle Material: Nylon 66 (UL)+GF
- Latch Spring Material: SWP Nickel Plated
- Flame Class: 94V-0
- Base Color: Black
- Handle Color: Blue
- Unit: mm
- Patented (專利品)

用途：適用上下雙層NGFF卡於機板上，免工具，易拆卸。

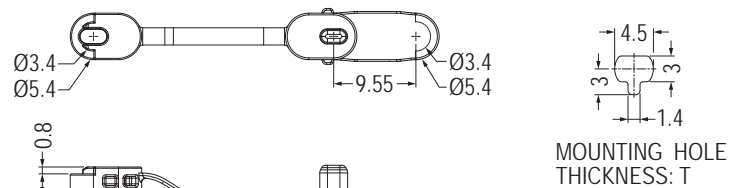

MOUNTING HOLE THICKNESS: T

Part No.	T	Package
★ULCOF-9SF	1.6	1000
ULCOF-9MF	1.93	
ULCOF-9F	2.36	

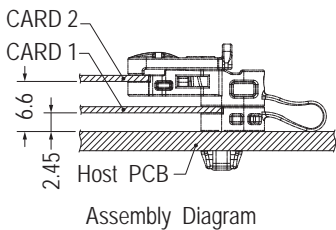

Assembly Diagram

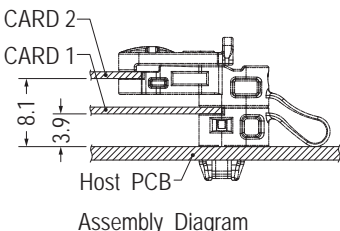

Assembly Diagram

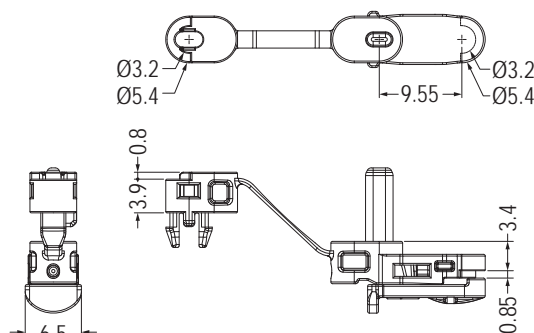

MOUNTING HOLE THICKNESS 1.6

Part No.	Package
ULCOF-19F	1000

M.2間隔柱 M.2 SSD SPACER

用途：適用上下雙層NGFF卡於機板上，免工具，易拆卸。

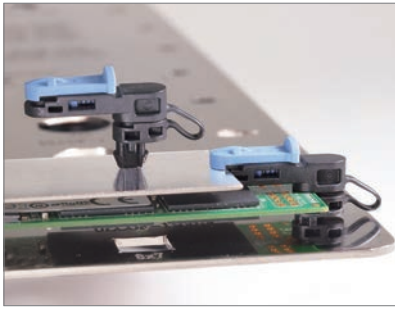

- Latch Base Material: Nylon 66 (UL)
- Latch Handle Material: Nylon 66 (UL)+GF
- Latch Spring Material: SWP Nickel Plated
- Flame Class: 94V-0
- Base Color: Black
- Handle Color: Blue
- Unit: mm
- Patented (專利品)

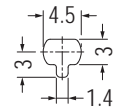
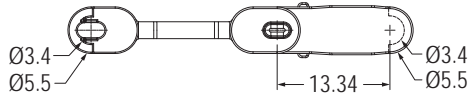
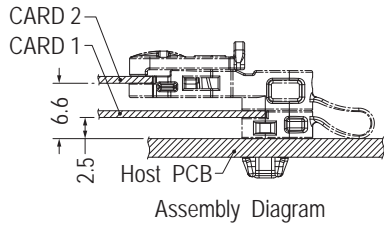

MOUNTING HOLE THICKNESS 2.0

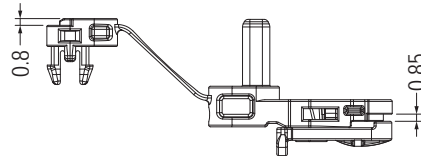

Part No.	Package
ULCOF-20F	1000

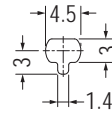
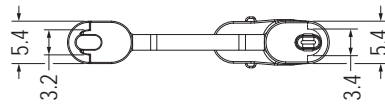
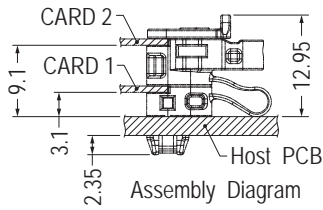

MOUNTING HOLE THICKNESS 2.6

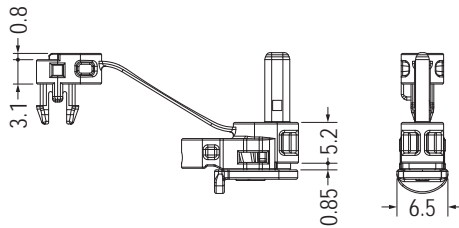

Part No.	Package
ULCOF-23F	1000



- Material: Nylon 66 (UL)
- Flame Class: 94V-0
- Color: Black
- Unit: mm
- Patented (專利品)

用途：適用NGFF卡於機板上，免工具，易拆卸。

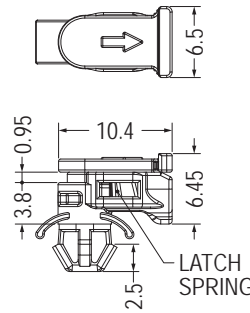
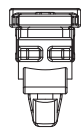

MOUNTING HOLE THICKNESS 1.6

Part No.	Package
ULCOF-2F	1000



- Material: Nylon 66 (UL)
- Flame Class: 94V-0
- Latch Base Color: Black
- Latch Cover Color: Blue
- Unit: mm
- Patented (專利品)

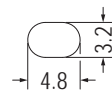
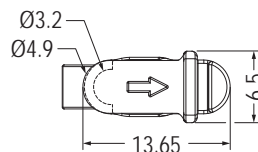

MOUNTING HOLE THICKNESS 1.6

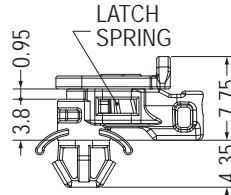
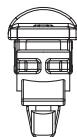

Part No.	Package
ULCOF-10F	1000

M.2間隔柱 M.2 SSD SPACER

用途：適用NGFF卡於機板上，免工具，易拆卸。

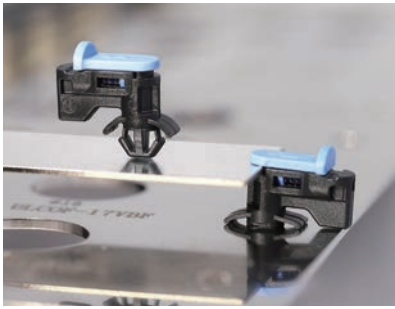

- Latch Base Material: Nylon 66 (UL)
- Latch Cover Material: Nylon 66 (UL)+GF
- Latch Spring Material: SWP Nickel Plated
- Flame Class: 94V-0
- Latch Base Color: Black
- Latch Cover Color: Blue
- Unit: mm
- Patented (專利品)

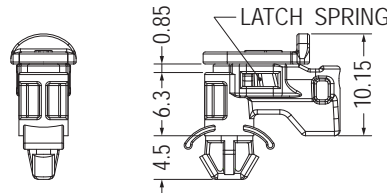
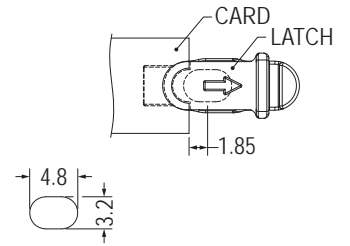
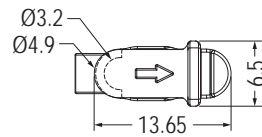

MOUNTING HOLE THICKNESS 1.57

Part No.	Package
ULCOF-17F	1000

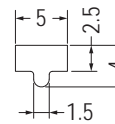
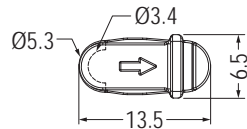
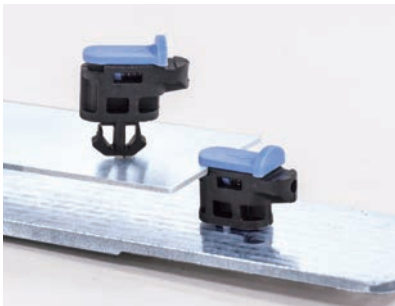

MOUNTING HOLE THICKNESS: T

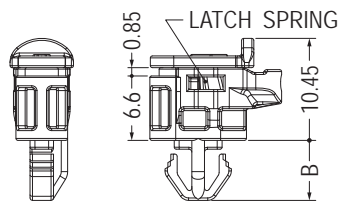

Part No.	B	T	Package
ULCOF-6SF	5.65	1.6	1000
ULCOF-6F	6.15	1.8, 2.2	
ULCOF-6LF	6.15	2.36~2.55	

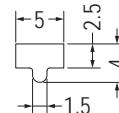
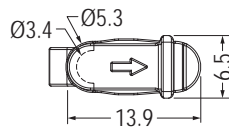
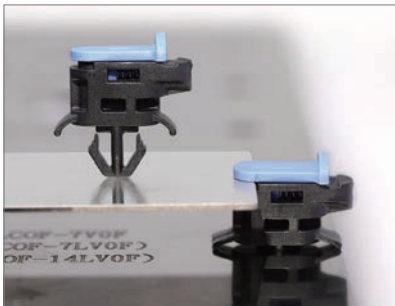

MOUNTING HOLE THICKNESS: T

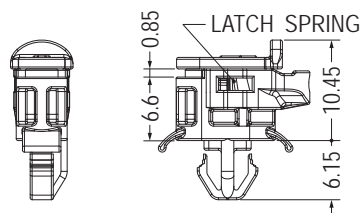

Part No.	T	Package
ULCOF-7F	1.93	1000
ULCOF-7LF	2.36~2.55	

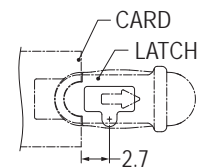
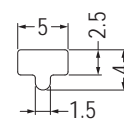
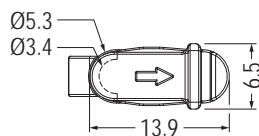

MOUNTING HOLE THICKNESS: T

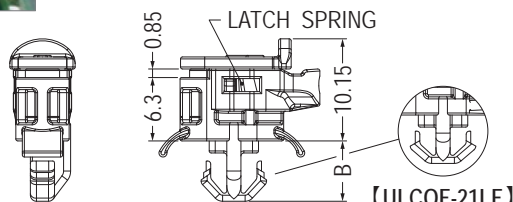

Part No.	B	T	Package
ULCOF-14LF	6.0	2.78	1000
ULCOF-21LF	4.8	1.93~2.4	

【ULCOF-21LF】

M.2間隔柱 M.2 SSD SPACER

用途：適用NGFF卡於機板上，免工具，易拆卸。

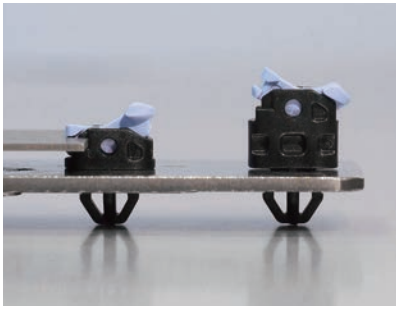

- Body Material: Nylon 66 (UL)
- Latch Material: Nylon 66 (UL)+GF
- Body Flame Class: 94V-2
- Latch Flame Class: 94V-0
- Body Color: Black
- Latch Color: Blue
- Unit: mm
- Patented (專利品)

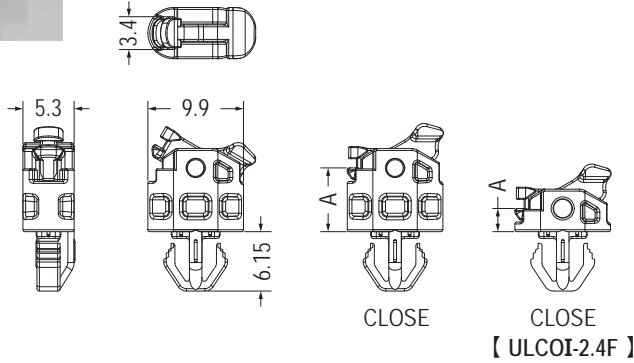
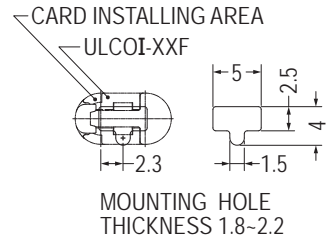

Part No.	A	Package
ULCOI-2.4F	2.4	1000
ULCOI-4F	4.0	
ULCOI-6.6F	6.6	

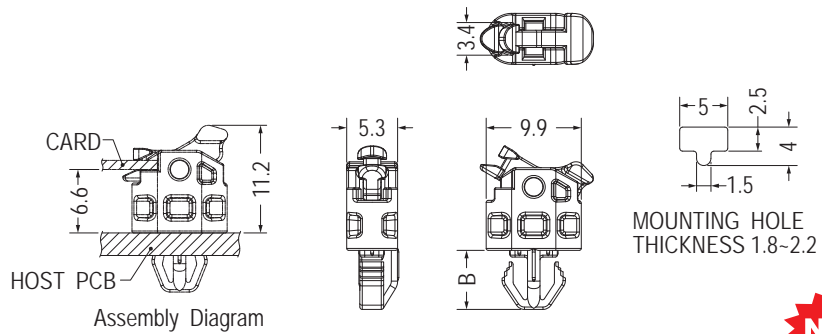
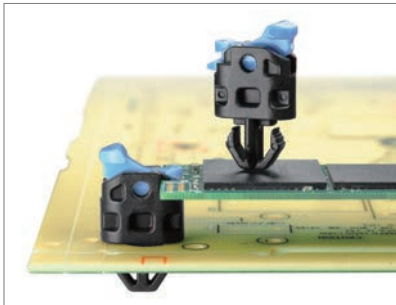

Part No.	B	Package
ULCOI-6S(BU2)F	5.65	1000
ULCOI-6(BU2)F	6.15	



- Body Material: Nylon 66 (UL)
- Latch Material: Nylon 66 (UL)+GF
- Body Flame Class: 94V-2
- Latch Flame Class: 94V-0
- Body Color: Black
- Latch Color: Blue
- Unit: mm
- Patented (專利品)

用途：用螺絲固定，適用NGFF卡於機板上，易拆卸。

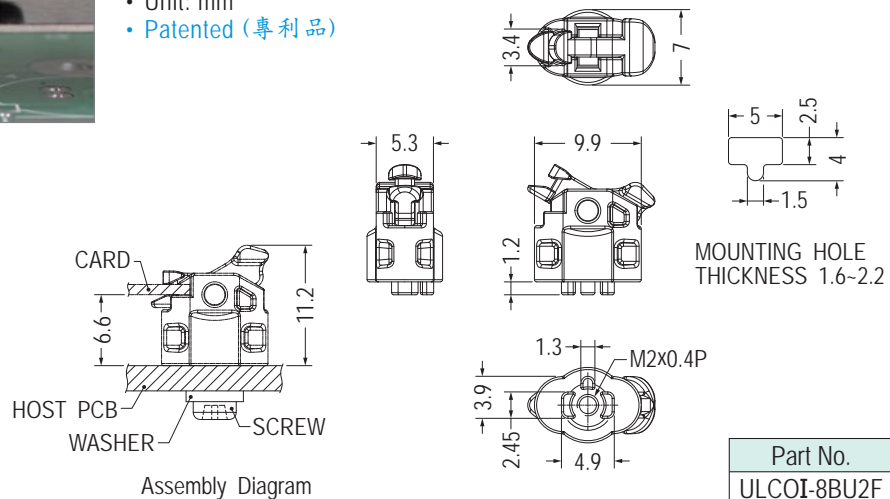

Part No.	Package
ULCOI-8BU2F	1000

M.2間隔柱 M.2 SSD SPACER

用途：適用NGFF卡於機板上，免工具，易拆卸。

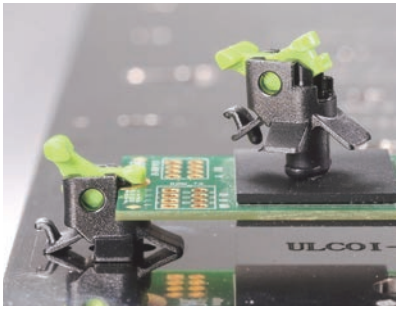

- Body Material: Nylon 66 (UL)
- Latch Material: Nylon 66 (UL)+GF
- Body Flame Class: 94V-2
- Latch Flame Class: 94V-0
- Body Color: Black
- Latch Color: Blue/Green
- Unit: mm
- Patented (專利品)

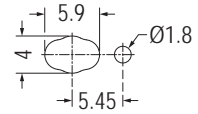
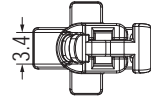

MOUNTING HOLE THICKNESS: T

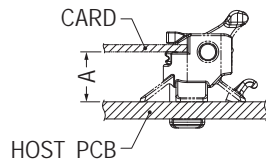

Assembly Diagram

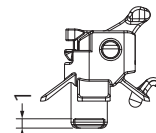
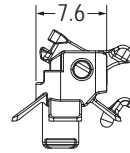
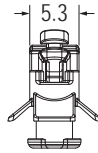

CLOSE

Part No.	A	T	Package
ULCOI-3F	5.0	2.36~2.55	1000
★ULCOI3-6.6F	6.6	1.8~2.2	

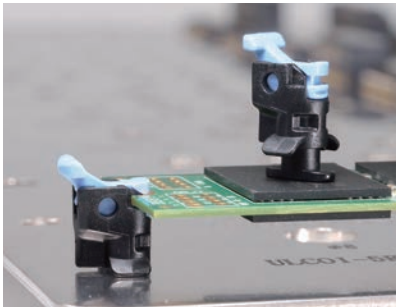

- Body Material: Nylon 66 (UL)
- Latch Material: Nylon 66 (UL)+GF
- Body Flame Class: 94V-2
- Latch Flame Class: 94V-0
- Body Color: Black
- Latch Color: Blue
- Unit: mm
- Patented (專利品)

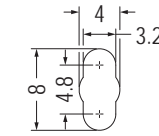
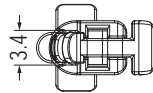

MOUNTING HOLE THICKNESS 1.9

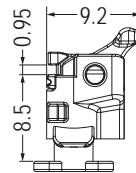
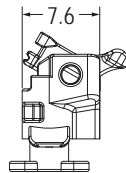
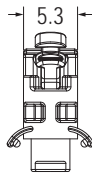
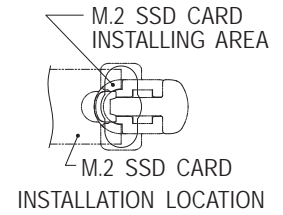

OPEN

CLOSE

Part No.	Package
ULCOI-5F	1000



- Body Material: Nylon 66 (UL)
- Latch Material: Nylon 66 (UL)+GF
- Flame Class: 94V-0
- Body Color: Black
- Latch Color: Blue
- Unit: mm
- Patented (專利品)

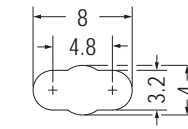
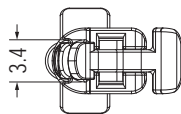

MOUNTING HOLE THICKNESS 1.6

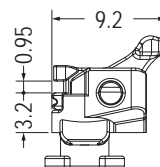
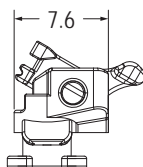
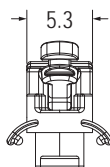
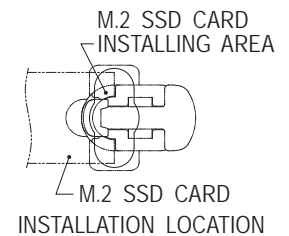

OPEN

CLOSE

Part No.	Package
ULCOI-9F	1000



M.2間隔柱 M.2 SSD SPACER

用途：通用NGFF卡於機板上，免工具，易拆卸。

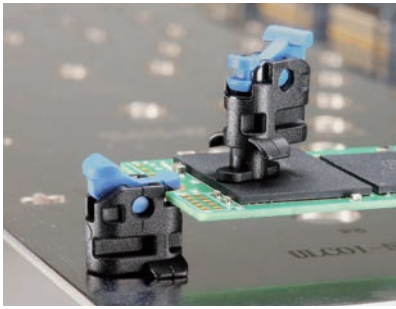

- Body Material: Nylon 66 (UL)
- Latch Material: Nylon 66 (UL)+GF
- Body Flame Class: 94V-2
- Latch Flame Class: 94V-0
- Body Color: Black
- Latch Color: Blue
- Unit: mm
- Patented (專利品)

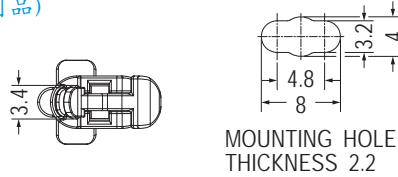

MOUNTING HOLE THICKNESS 2.2

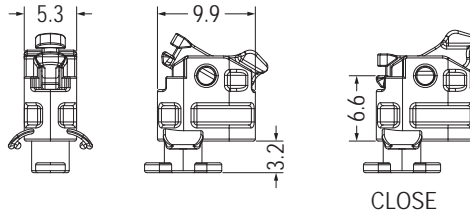

CLOSE



Part No.	Package
ULCOP-6.6F	1000

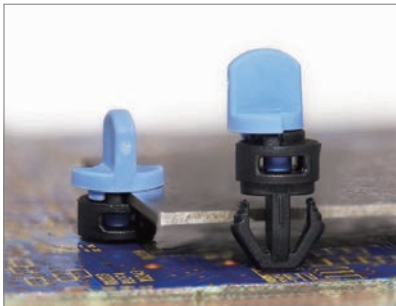

- Material: Nylon 66 (UL)
- Flame Class: 94V-0
- Latch Base Color: Black
- Latch Turn Handle Color: Blue/Gray
- Unit: mm
- Patented (專利品)

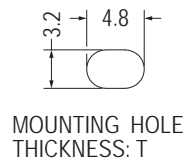
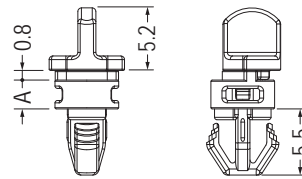
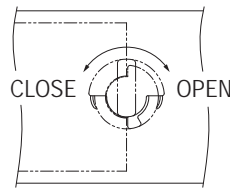
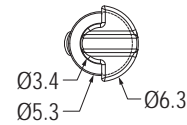

MOUNTING HOLE THICKNESS: T

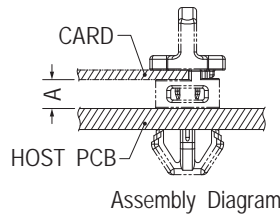

Assembly Diagram

Part No.	A	T	Package
ULCON-1F	2.4	1.6~2.1	1000
★ULCON-1-6F	6.6	1.6~2.1	
★ULCON-1M-6F	6.6	1.93~2.4	



使用說明
Installation Guide

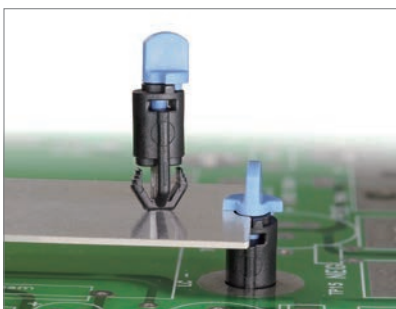

- Latch Base Material: Nylon 66 (UL)
- Latch Turn Handle Material: Nylon 66 (UL)+GF
- Flame Class: 94V-0
- Latch Base Color: Black
- Latch Turn Handle Color: Blue
- Unit: mm
- Patented (專利品)

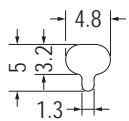
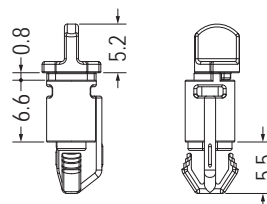
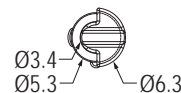
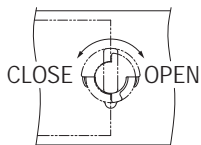

MOUNTING HOLE THICKNESS 1.6~2.1

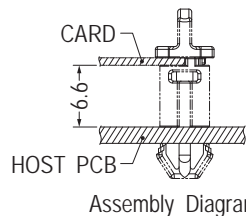

Assembly Diagram



Part No.	Package
ULCON-8F	1000

M.2間隔柱 M.2 SSD SPACER

用途：適用NGFF卡於機板上，免工具，易拆卸。



- Material: Nylon 66 (UL)
- Flame Class: 94V-0
- Latch Base Color: Black
- Latch Turn Handle Color: Gray
- Unit: mm
- Patented (專利品)

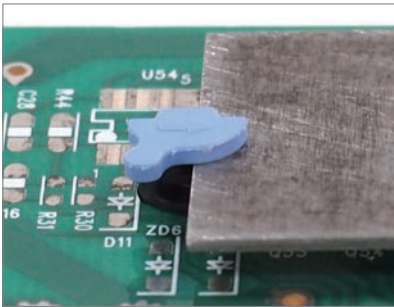
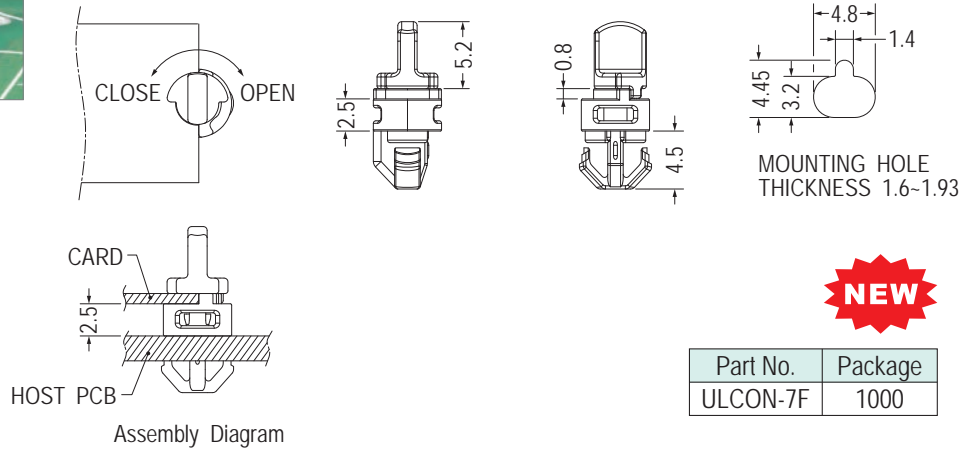

- Material: Nylon 66 (UL)
- Flame Class: 94V-0
- Latch Base Color: Black
- Latch Turn Handle Color: Blue
- Unit: mm
- Patented (專利品)

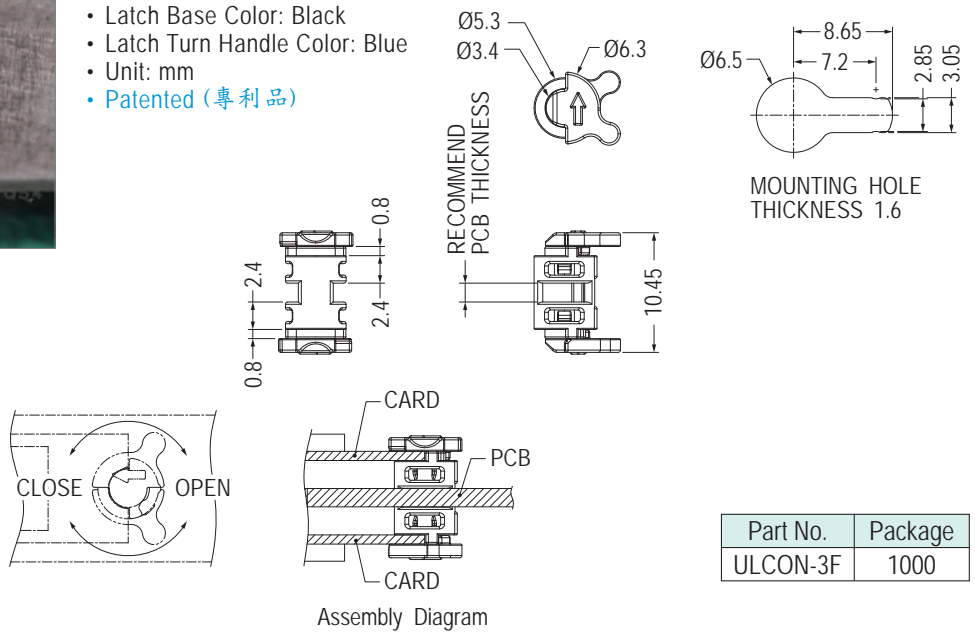

使用說明
Installation Guide

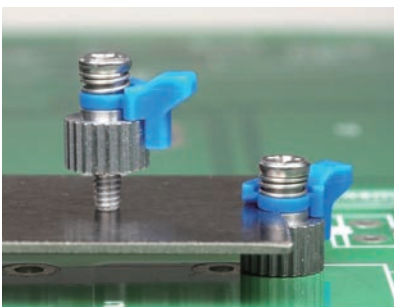

- Metal Material: Steel
- Insulator Material: POM
- Insulator Color: Blue
- Unit: mm
- Patented (專利品)

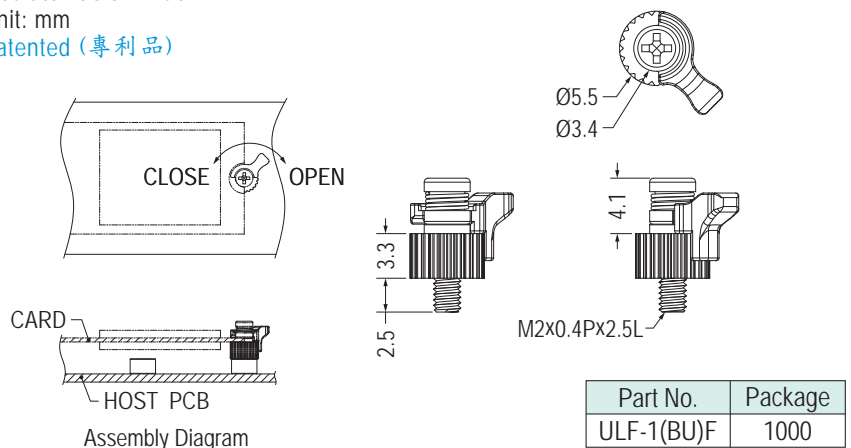

M.2間隔柱 M.2 SSD SPACER

用途：適用NGFF卡於機板上，免工具，易拆卸。

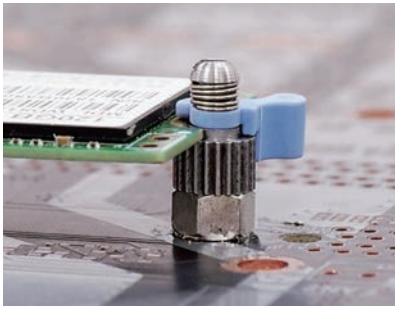

- Metal Material: Steel
- Insulator Material: Nylon 66 (UL)+GF
- Flame Class: 94V-0
- Insulator Color: Blue
- Unit: mm
- Patented (專利品)

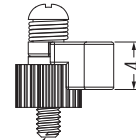
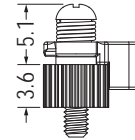
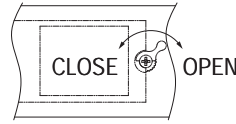
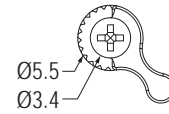

M2X0.4PX2.5L

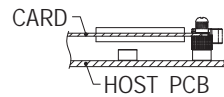

Assembly Diagram



使用說明
Installation Guide

Part No.	Package
ULF-3.6(BU)F	1000

WI-FI固定扣 WI-FI LOCK

用途：用於NGFF卡用之天線端子固定與保護。



- Material: Nylon 66 (UL)/PC (UL)
- Flame Class: 94V-2/94V-0
- Color: Black/Transparent
- Unit: mm

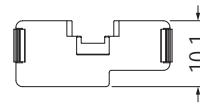
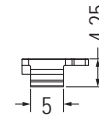
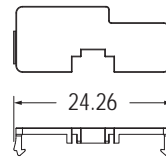

Part No.	Package
UNCV-1	1000

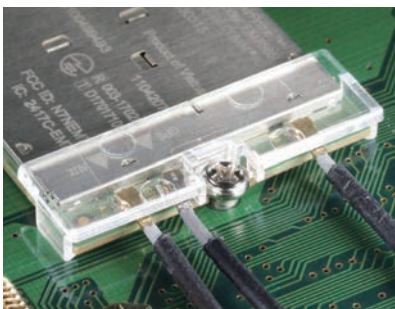

- Material: Nylon 66 (UL)
- Flame Class: 94V-2
- Color: Black
- Unit: mm

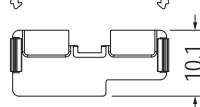
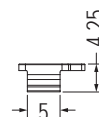
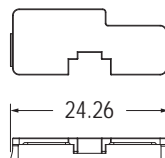

Part No.	Package
UNCV-2	1000

- Material: PC (UL)
- Flame Class: 94V-2
- Color: Transparent
- Unit: mm

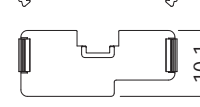
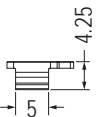
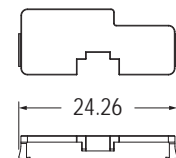

Part No.	Package
UNCV-3	1000

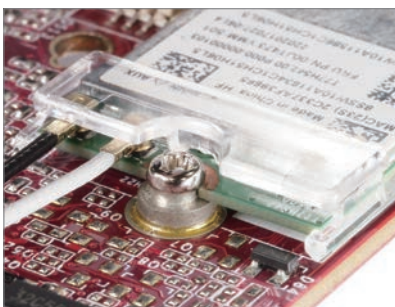

- Material: PC (UL)
- Flame Class: 94V-2
- Color: Transparent
- Unit: mm

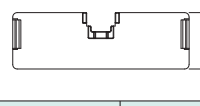
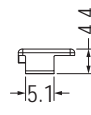
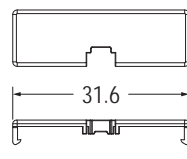

Part No.	Package
★UNCV-4	1000

- Material: PC (UL)
- Flame Class: 94V-0
- Color: Transparent
- Unit: mm

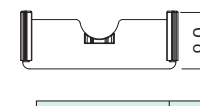
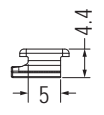
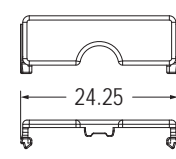

Part No.	Package
★UNCV-6	1000