

10

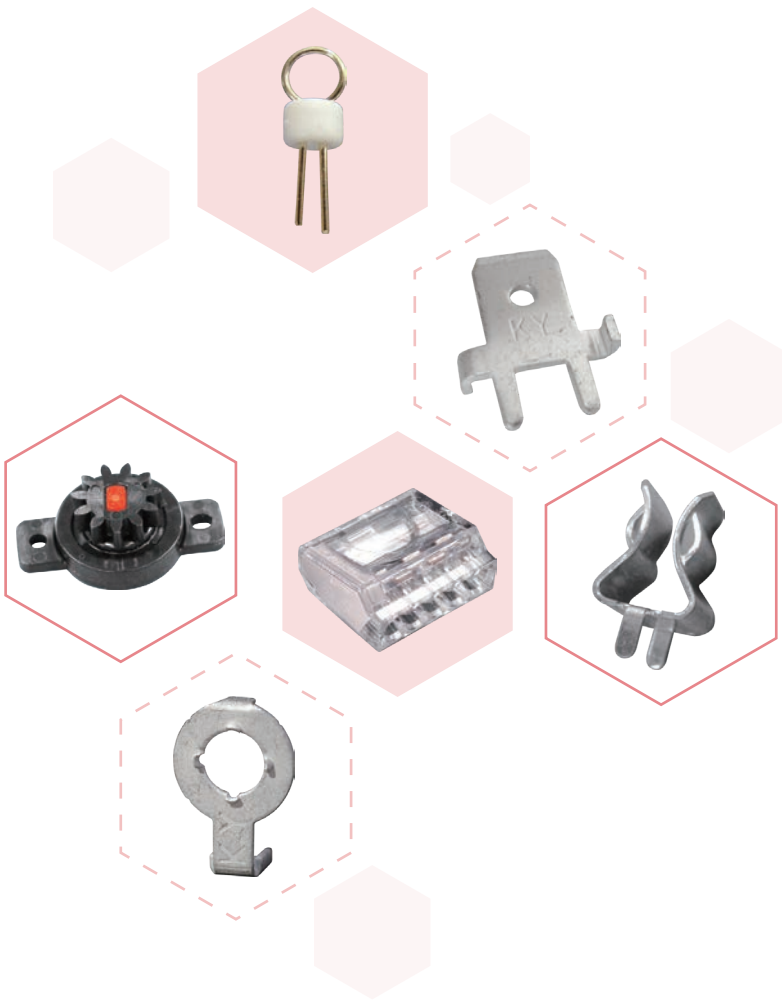

- 阻尼齒輪
Damper Gears
- PC板焊接端子
PCB Terminals
- 測試針/測試點
Test Pins
- 保險絲座/測試座
Fuse & Test Holders
- 接地片
Ground Terminals
- 端子台
Terminal Blocks
- 接線夾/跳線
Quick Splices & Jumper Wires



插式電線連接頭 PUSH-IN WIRE CONNECTOR

用途：用於單芯電源線之連接，插入式，免用膠帶，方便，省時。

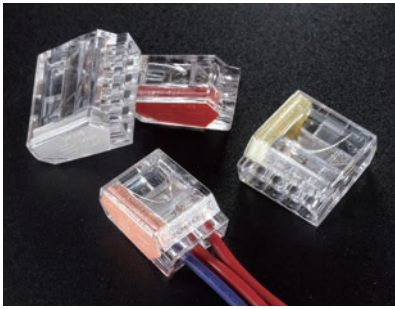

- Material: PC (UL) 94V-0
- Unit: mm



NOTE:

安培(Current): 24A(VDE)

伏特(Voltage): 600V

使用溫度(Working temp): 110°C

使用線徑範圍(Wire Range): #12-22 AWG Solid conductor

撥線長度(Stripping Length): 11mm(0.43 inch)

顏色(Color): 以顏色區分,易於辨別使用電線數目

(The colors are used to define the numbers of connector poles.)

安全認證通過(Safety Certification):

美國USA(UL),德國Germany(VDE),芬蘭Finland(Finko),歐洲Europe(CE)

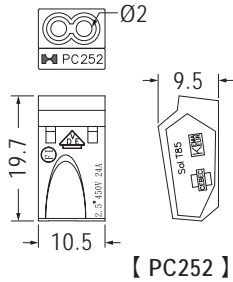

【 PC252 】

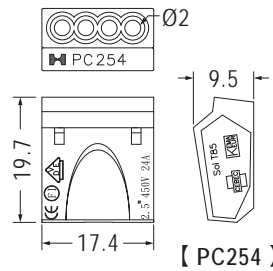

【 PC254 】

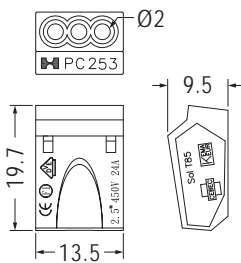

【 PC253 】

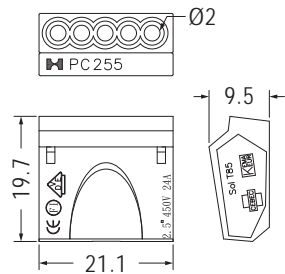

【 PC255 】

Part No.	Color	Poles	Package
PC252	Red	2	500
PC253	Orange	3	
PC254	Yellow	4	
PC255	Gray	5	

快速接線夾 QUICK SPLICE

用途：用於中途輔助接線，且使用時不需剝線，將電線放好位置壓入銅片即可，省時美觀。

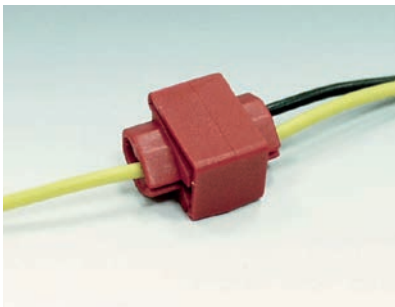

- Housing Material: PP
- Metal Material: Copper
- Finish: Tin Plated
- Unit: mm

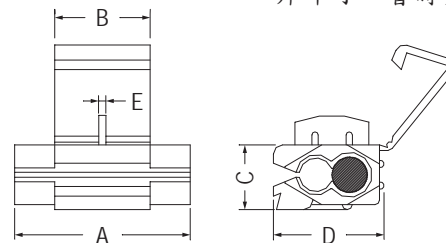

Part No.	Wire Range AWG	A	B	C	D	E	Color	Package
3MR	22-18	19.5	10.6	8.2	13.5	0.8	Red	500
3MB	18-14	19.5	10.6	8.2	13.5	0.8	Blue	
3MY	12-10	20.0	20.0	11.1	15.0	0.9	Yellow	200

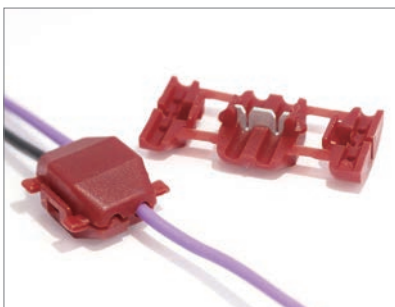

- Insulation Material: Nylon
- Insulation Color: Red
- Terminal Material: Brass
- Wire Range: #20-18 AWG(0.5-0.75mm)
- Terminal Thickness: 0.8mm
- Plating: Tin Plated
- Unit: mm

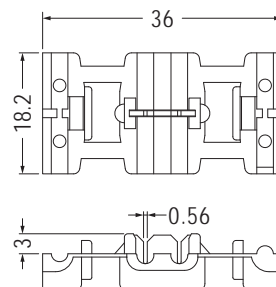

Part No.	Package
878008	250

端子台 TERMINAL BLOCK

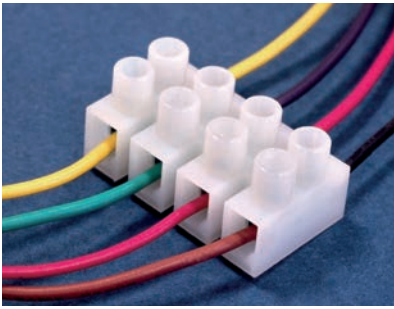

- Housing Material: Nylon 66 UL94V-2
- Pole: 1~12 Poles
- Working Temperature: 105°C
- PA7DS, PA9DS: With Wire Protector
- Safety Certification: UL、CSA、VDE、F、D、N、S...。
- Color: Natural



- H=底部加高(Raised Base)
- DS=加彈片(Wire Protector)
- F=平底型(Flat Base Type)

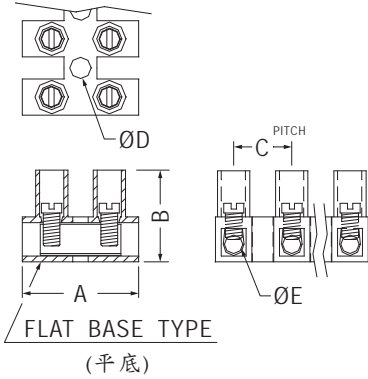
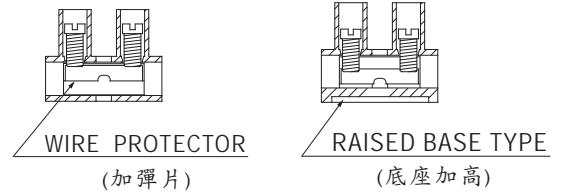

Part No.	線徑 mm ²	安培 Amp	電壓 Volt	螺絲 Screw	A	B	C	D	E	Poles
PA7-12	1.5	17.5	450V	M2.6x5P	17.0	14.5	8.2	2.9	2.8	12
PA7-12DS	1.5	17.5	450V	M2.6x5P	17.0	14.5	8.2	2.9	2.8	
PA7F-12	1.5	17.5	450V	M2.6x5P	17.0	13.5	8.2	2.9	2.8	
PA7F-12DS	1.5	17.5	450V	M2.6x5P	17.0	13.5	8.2	2.9	2.8	
PA9-12	2.5	24.0	450V	M3.0x6P	20.2	16.7	10.0	3.6	3.2	
PA9-12DS	2.5	24.0	450V	M3.0x6P	20.2	16.7	10.0	3.6	3.2	
PA9F-12	2.5	24.0	450V	M3.0x6P	20.2	16.2	10.0	3.6	3.2	

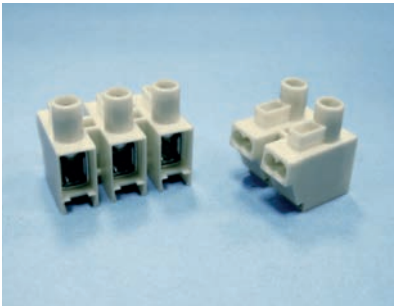

- Housing Material: Nylon 66 (UL) 94V-2
- Working Temperature: 105°C
- Color: Natural
- Unit: mm

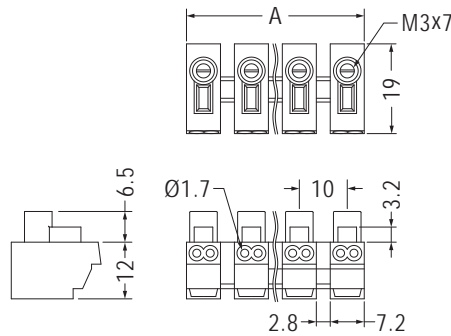

Part No.	A
PA11-2P	17.3
PA11-3P	27.5

按壓式端子台 PUSH-BUTTON TERMINAL BLOCK



- Material: PP
- Working Temperature: 85°C
- Color: White
- Unit: mm

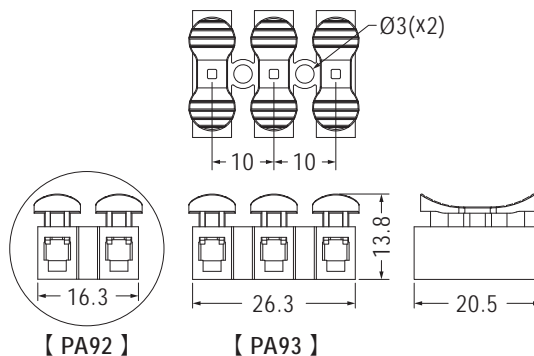

Part No.	線徑 mm ²	安培 Amp	電壓 Volt
PA92	0.5~2.5	10.0	250V
PA93	0.5~2.5	10.0	250V

端子座 TERMINAL BLOCK

用途：用於大電流機器接線。

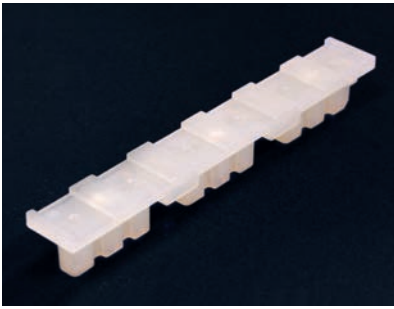

- Material: PC (UL)
- Flame Class: 94V-2/94V-0
- Color: Natural
- Unit: mm

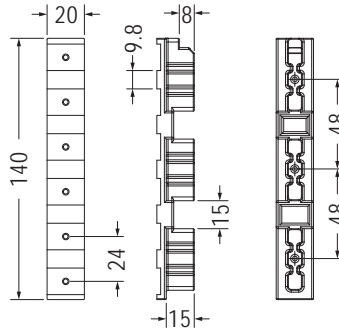

Part No.	Package
TERBL-6	50

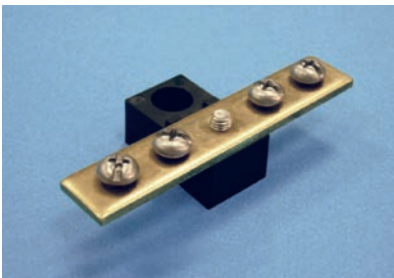

- Material: PBT (UL)
- Flame Class: 94V-0
- Color: Black
- Unit: mm

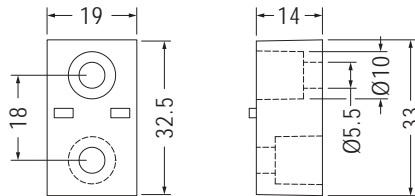

Part No.	Package
TERBL-33	200

彈簧螺紋端子 SCREW-ON CONNECTOR

用途：連接電線，內附彈簧，旋轉時彈簧則夾緊電線不易脫落。



- Material: PP
- Color: Orange
- Unit: mm
- Wire Spring Insert

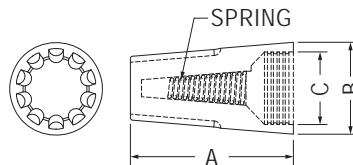

Part No.	Wire Size Range		A	B	C	Package
	Max.	Min.				
P1	#18x2	#24x2	15.2	8.6	6.5	1000
P2	#16x3	#20x3	17.7	9.9	7.1	
P3	#14x3	#18x3	22.0	12.4	9.8	
P4	#14x3	#16x3	24.6	14.0	11.0	

- Material: PBT (UL) 94V-0
- Color: Black
- Unit: mm
- Wire Spring Insert

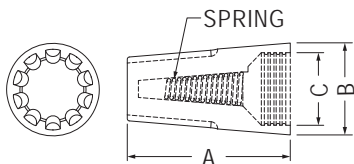

Part No.	A	B	螺紋 內徑 C	適用電線範圍 Suitable Wires AWG	Package
P1B	15.2	8.6	6.5	22-18	1000
P3B	21.8	12.7	9.6	22-14	500

閉端端子 CLOSE END CONNECTOR

用途：電線剝去外皮插入端子內，用工具壓著即可，接觸良好不脫落。

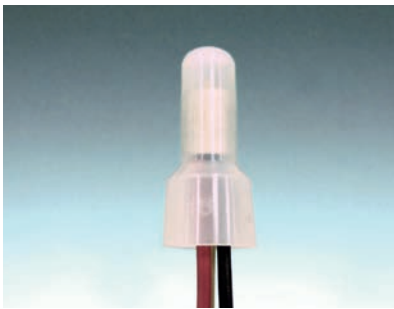

- Housing Material: Nylon 66 (UL) 94V-2
- Metal Material: Aluminum
- Color: Natural
- Unit: mm

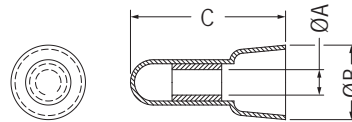

Part No.	Wire Range	A	B	C	Package
CE1	#22-18	2.6	7.8	18.0	1000
CE2	#22-14	3.1	9.5	20.0	
CE5	#22-10	4.4	12.5	25.2	

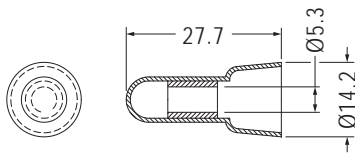

- Metal Material: Tin Plated Copper

Part No.	Wire Range	Package
CE8	#16-10	500

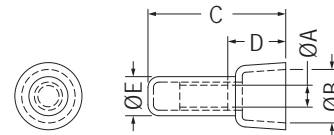

- Metal Material: Copper

Part No.	Wire Range	A	B	C	D	E	Package
C3	#22-16 1.25 mm ²	2.7	6.5	18.0	7.7	5.1	1000
C4	#16-14 2 mm ²	3.3	7.9	20.2	8.5	5.6	
C5	#12-10 5.5 mm ²	4.3	10.5	24.7	11.6	7.2	
C8	#8 8 mm ²	5.3	12.2	27.3	13.0	9.2	500

防水接線帽 WATERPROOF WIRE CONNECTORS

用途：通過UL486D認證，防水標準IP55等級適用於潮濕掩埋，可防水、防塵、防腐。可快速接線，剝線13-16mm線芯插入接線帽底部後，鎖緊即可。0.82-21mm²單芯、絞線、花線皆可使用。



- Material: Tough thermoplastic (PP)
- Spring Insert: Steel
- Color: Blue/Red/Black
- Unit: mm
- 耐壓(Voltage): 600V
- 使用溫度(Working temp): 105°C

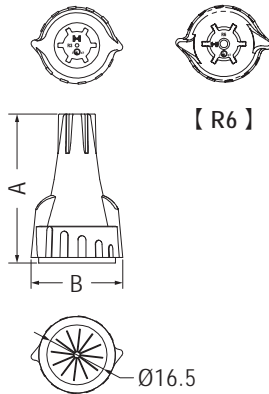

Part No.	Wire Range		A	B	Package
	Max.	Min.			
R3	3#12	2#20	40.9	25.2	100
R6	4#10	3#16	47.2	26.5	

電線固定夾片 WIRE CLAMP

用途：使用於電子、電腦產品內部電線之固定，可彎曲打開重覆使用，維修方便。



- Metal Material: Steel
- Plastic Material: PVC Tube (UL)
- Color: Black
- Unit: mm

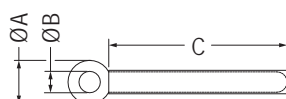

Part No.	A	B	C	Package
WL3-32T	7.5	3.3	32.0	1000
WL3-52T	7.5	3.3	52.0	
WL3-60T	8.0	3.6	62.0	
WL4-35T	8.5	4.2	35.0	
WL4-50T	8.0	4.1	52.0	
WL4-70T	7.5	4.2	74.5	
WL4-78T	8.0	4.1	78.5	500
WL5-70T	8.4	5.1	60.0	
WL6-78T	10.0	6.0	78.0	

電線固定夾片 WIRE CLAMP

用途：使用於電子、電腦產品內部電線之固定，可彎曲打開重覆使用，維修方便。



- Metal Material: Steel
- Plastic Material: Polyolefin (UL)
- Color: Black
- Unit: mm

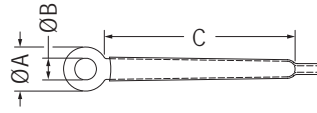

Part No.	A	B	C	Package
WL3-12H	7.5	3.3	12.0	1000
WL3-32H	7.5	3.3	32.0	
WL3-35H	5.6	3.5	29.9	
WL3-52H	7.5	3.2	52.0	
WL3-60H	8.0	3.6	62.0	
WL4-35H	8.5	4.2	35.0	
WL4-50H	8.0	4.1	52.0	
WL4-56H	8.0	4.1	48.2	
WL4-70H	7.5	4.2	74.5	500
WL4-78H	8.0	4.1	78.5	
WL4-90H	7.5	4.2	94.5	
WL5-70H	8.4	5.1	60.0	
WL6-78H	10.0	6.0	78.0	



- Metal Material: Steel
- Plastic Material: PVC Tube (UL)
- Color: Black
- Unit: mm

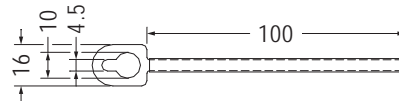

Part No.	Package
WLC-1	500



- Metal Material: Tin Plated Steel
- Plated Material: Polyolefin (UL)/PVC Tube (UL)
- Color: Black
- Unit: mm

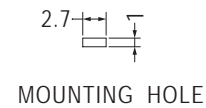
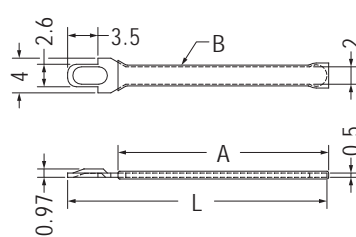

Part No.	A	B	L	Package
WLD-30H	24.0	1.5 Heat Shrinking	30.0	1000
WLD-50H	47.0	1.5 Heat Shrinking	50.0	
WLD-30T	25.0	1.93 PVC Tube	30.0	
WLD-50T	45.0	1.93 PVC Tube	50.0	

測試點 TEST PIN

用途：焊於電子，電腦PC板上重要測試端點，可勾掛探棒，不短路，鍍金接觸良好，不氧化。

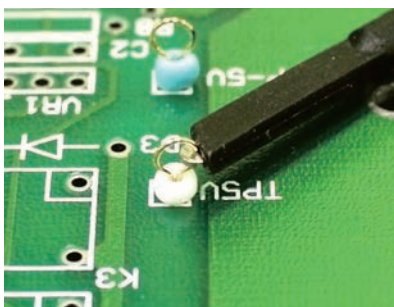

- Material: PBT (UL)
- Flame Class: 94V-0
- Pin Material: Phosphor Bronze
- Pin Finish: Gold Plated
- Unit: mm

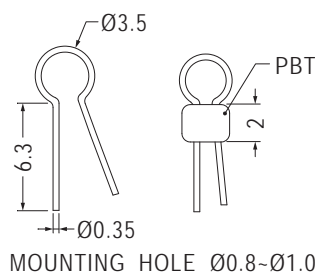

Part No.	Color	Package
TEST-1(R)	Red	1000
TEST-1(GR)	Green	
TEST-1(BU)	Blue	
TEST-1(BK)	Black	
TEST-1(Y)	Yellow	
TEST-1(W)	White	

測試點 TEST PIN



- Material: PBT (UL)
- Flame Class: 94V-0
- Pin Material: Phosphor Bronze
- Pin Finish: Gold Plated
- Unit: mm

用途：焊於電子，電腦PC板上重要測試端點，可勾掛探棒，不短路，鍍金接觸良好，不氧化。

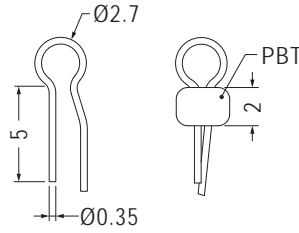

MOUNTING HOLE Ø0.8-Ø1.0

- Color: Black

Part No.	Package
TEST-3S	500

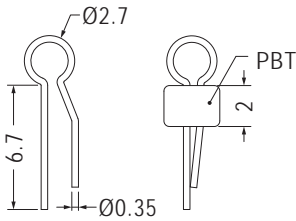

MOUNTING HOLE Ø0.8-Ø1.0

Part No.	Color	Package
TEST-3(R)	Red	1000
TEST-3(GR)	Green	
TEST-3(BU)	Blue	
TEST-3(BK)	Black	
TEST-3(Y)	Yellow	
TEST-3(W)	White	

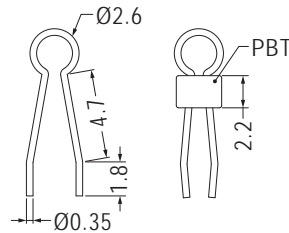

MOUNTING HOLE Ø0.8-Ø1.0

Part No.	Color	Package
TEST-7(R)	Red	1000
TEST-7(G)	Green	
TEST-7(BU)	Blue	
TEST-7(BK)	Black	
TEST-7(Y)	Yellow	
TEST-7(W)	White	

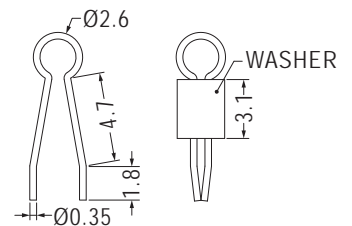

MOUNTING HOLE Ø0.8-Ø1.0

- Washer Material: Ceramic
- Color: Milk White

Part No.	Package
TEST-7CN	1000



- Material: PBT (UL)
- Flame Class: 94V-0
- Pin Material: Phosphor Bronze
- Pin Finish: Gold Plated
- Unit: mm

用途：焊於電子，電腦PC板上重要測試端點，可勾掛探棒，不短路，鍍金鍍錫接觸良好，不氧化。

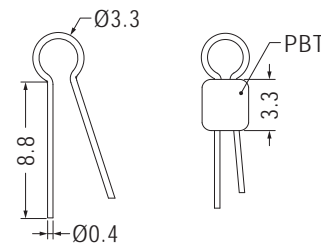

MOUNTING HOLE Ø0.9-Ø1.0

Part No.	Color	Package
TEST-55R	Red	1000
TEST-55GR	Green	
TEST-55BU	Blue	
TEST-55(B)	Black	
TEST-55Y	Yellow	
TEST-55W	White	

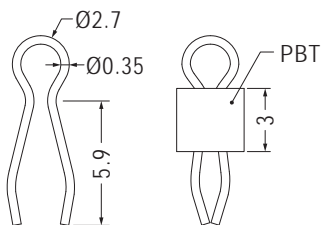

MOUNTING HOLE Ø1.5

- Pin Finish: Tin Plated

Part No.	Color	Package
TEST-87(R)	Red	1000
TEST-87(GR)	Green	
TEST-87(BU)	Blue	
TEST-87(B)	Black	
TEST-87(Y)	Yellow	
TEST-87	White	

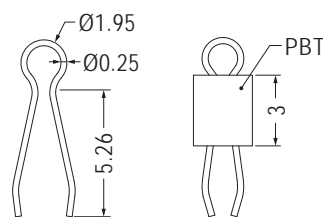

MOUNTING HOLE Ø1.0

- Color: White

Part No.	Package
TEST-129	1000

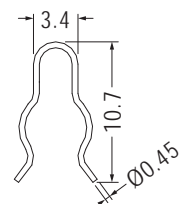

MOUNTING HOLE Ø0.8-Ø1.0

Part No.	Package
TEST-2	1000

測試針 TEST PIN

用途：焊於電子，電腦PC板上重要測試端點，接觸良好，不氧化。

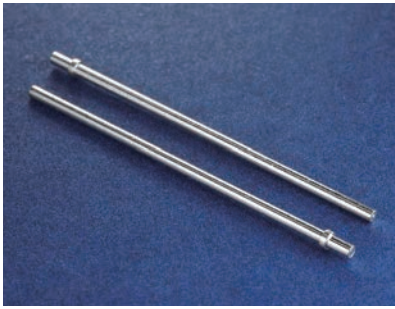

- Material: Tin Plated Brass
- Unit: mm

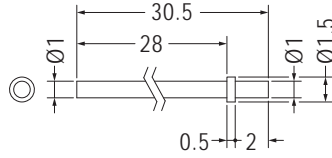

Part No.	Package
TEST-159	1000

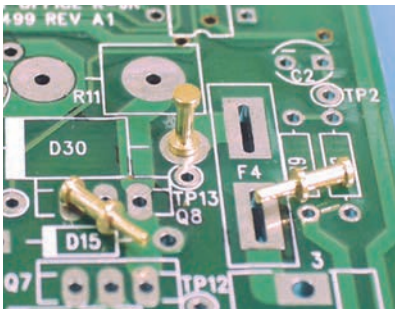

- Material: Gold Plated Brass
- Unit: mm

用途：焊於電子，電腦PC板上重要測試端點，鍍金接觸良好，不氧化。

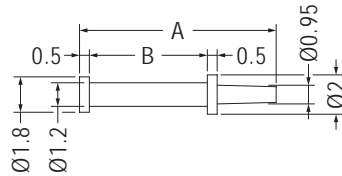

MOUNTING HOLE Ø0.9-Ø1.0

Part No.	A	B	Package
TEST-4	14.0	10.0	1000
TEST-5	10.0	6.0	2000

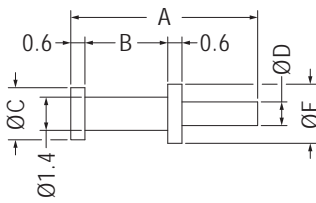

MOUNTING HOLE Ø1.0

Part No.	A	B	C	D	E	Package
TEST-22	7.9	3.5	2.2	1.0	2.5	2000
TEST-34	8.0	3.8	1.6	0.8	1.6	

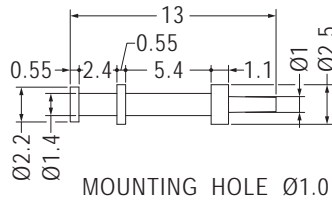

MOUNTING HOLE Ø1.0

Part No.	Package
TEST-8	2000

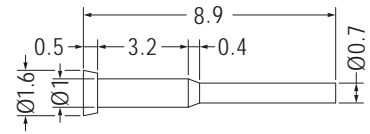

Part No.	Package
TEST-31	2000



- Material: Nickel Plated Brass
- Unit: mm

用途：焊於電子，電腦PC板上重要測試端點，鍍鎳接觸良好，不氧化。

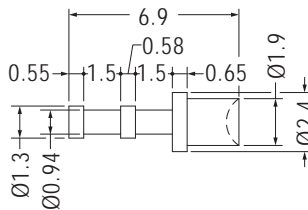

MOUNTING HOLE Ø2.0

Part No.	Package
TEST-6	2000



- Material: Tin Plated Copper
- Unit: mm

用途：焊於電子，電腦PC板上重要測試端點，接觸良好，不氧化。

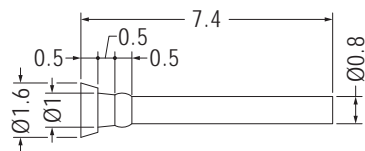

MOUNTING HOLE Ø0.8-Ø0.9

Part No.	Package
TEST-10	2000

測試針 TEST PIN

用途：焊於電子，電腦PC板上重要測試端點，接觸良好，不氧化。



- Material: Tin Plated Brass
- Unit: mm

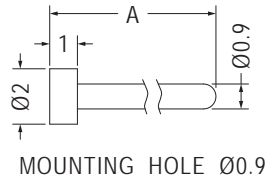

Part No.	A	Package
TEST-24	15.0	2000
TEST-25	6.0	
TEST-26	8.5	
TEST-28	10.0	

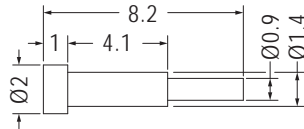

Part No.	Package
TEST-140	1000

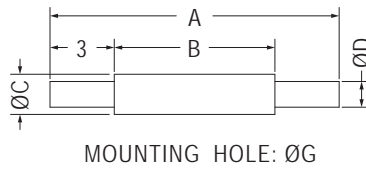

Part No.	A	B	C	D	G	Package
TEST-9	16.0	10.0	1.5	1.0	1.0	2000
TEST-23	18.0	10.0	2.5	1.6	1.7	
TEST-136	19.5	16.5	2.5	1.6	1.7	

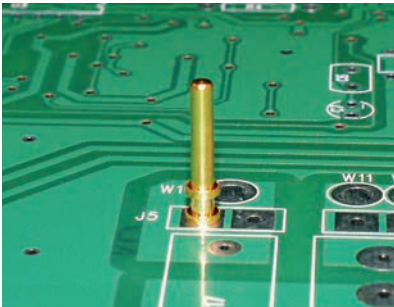

- Material: Gold Plated Brass
- Unit: mm

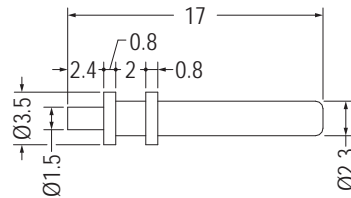

Part No.	Package
TEST-27	2000



- Material: Tin Plated Brass
- Unit: mm

用途：焊於電子，電腦PC板上重要測試端點，可勾掛探棒，不短路，接觸良好，不氧化。

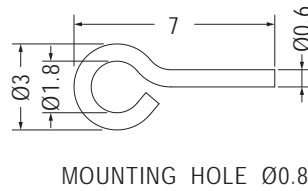

Part No.	Package
TEST-12	2000

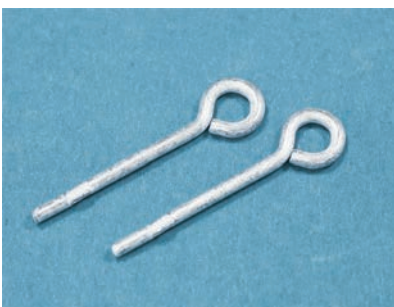

- Material: Tin Plated Copper
- Unit: mm

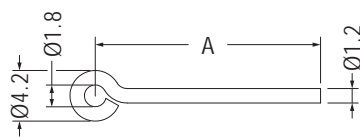

Part No.	A	Package
JUMP-21	18.7	1000
JUMP-34	15.0	

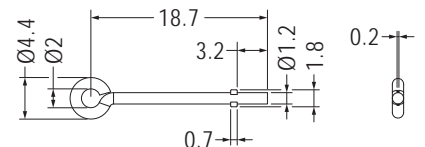

Part No.	Package
JUMP-26	2000

測試點 TEST PIN

用途：配合焊接，做為PC板與PC板之導電與間隔之用或測試端點。

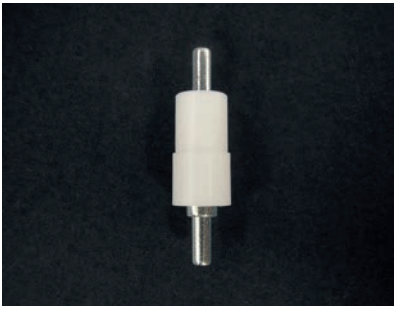

- Material: Nylon 66 (UL)/94V-0
- Pin Material: Brass
- Color: Natural
- Unit: mm

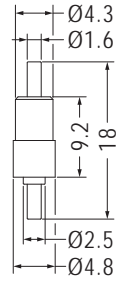

Part No.	Package
ROFF-10F	1000

測試座 TEST HOLDER

用途：做為電路板電氣連接或測試端點。

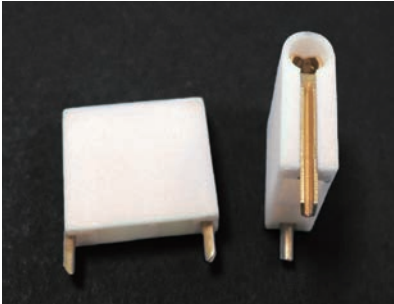

- Material: Nylon 66 (UL)
- Material: Gold Plated Brass
- Flame Class: 94V-0
- Color: Natural
- Unit: mm

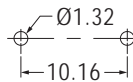
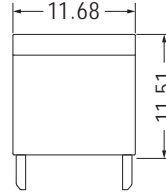
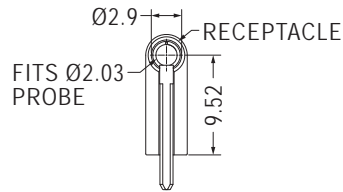

RECOMMENDED MOUNTING HOLE PARTERN

Part No.	Package
TEST-114	1000

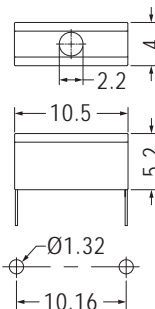
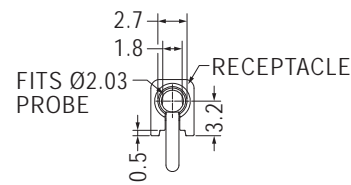
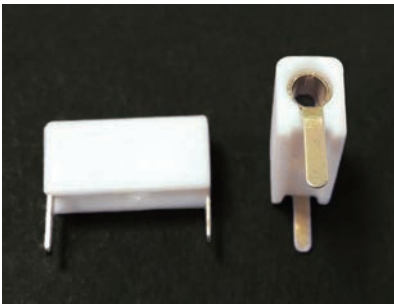

RECOMMENDED MOUNTING HOLE PARTERN

Part No.	Package
TEST-115	1000

跳線 JUMPER WIRE

用途：做為跳線使用。



- Material: Tin Plated Copper
- Plastic Material: Polyolefin (UL)
- Color: Black
- Unit: mm

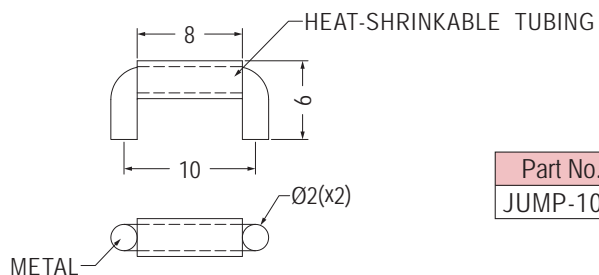

Part No.	Package
JUMP-10H	1000

保險絲座 FUSE HOLDER

用途：用於保險絲之絕緣與間隔。

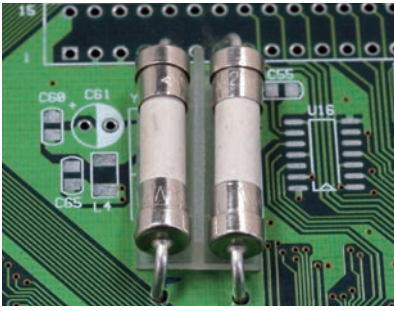

- Material: PC (UL)
- Flame Class: 94V-2/94V-0
- Color: Natural
- Unit: mm

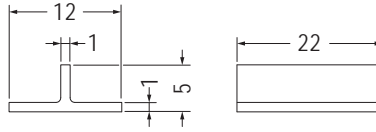

Part No.	Package
FHBBU-22	1000

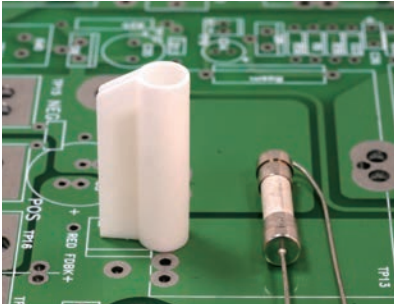

- Material: Nylon 66 (UL)
- Flame Class: 94V-2/94V-0
- Color: Natural/Black
- Unit: mm

用途：將保險絲固定於PCB板座上，拆卸方便。

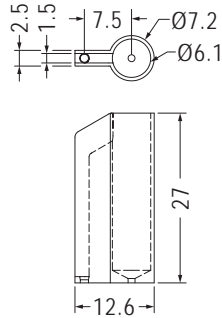

Part No.	Package
FUSCV-1	500

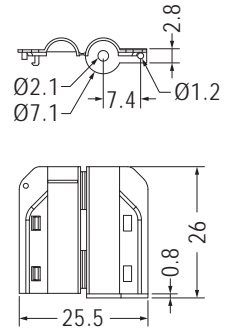
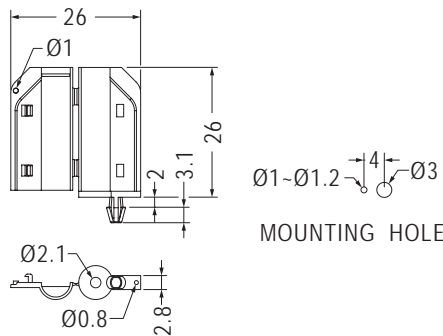
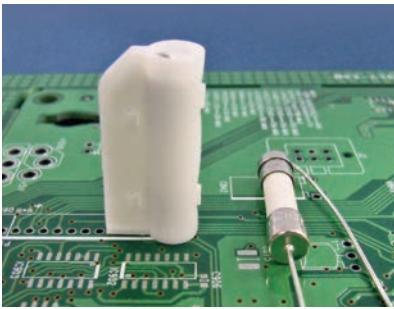

Part No.	Package
FUSCV-3	500

Part No.	Package
FUSCV-10	500



- Material: PBT (UL)
- Flame Class: 94V-0
- Color: Natural
- Unit: mm

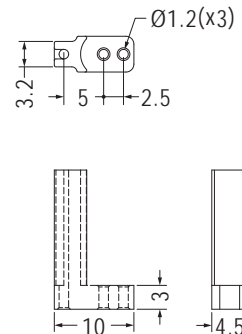
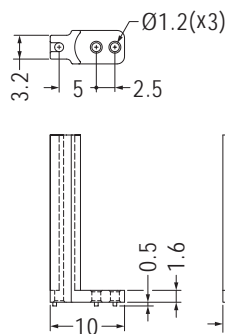

Part No.	Package
FUSCV-2	500

Part No.	Package
FUSCV-4	500

保險絲座 FUSE HOLDER

用途：將保險絲固定於PC板上，拆裝方便。

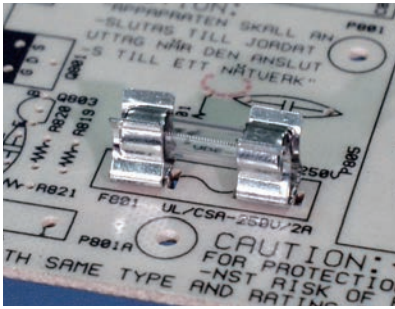

- Material: Bright Tin Plated Phosphor Bronze
- Unit: mm

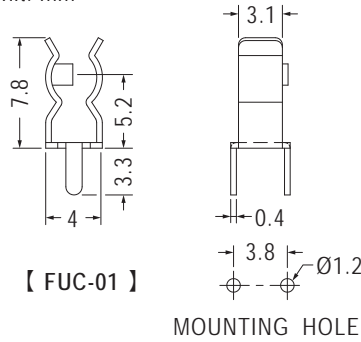

Part No.	適用保險絲 Cartridge Fuse	Package
FUC-01	Ø3.6	1000
FUC-02	Ø5.2	
FUC-17A	Ø5.2	

- Material: Bright Tin Plated Brass
- Unit: mm

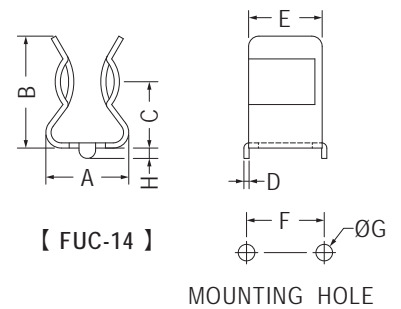
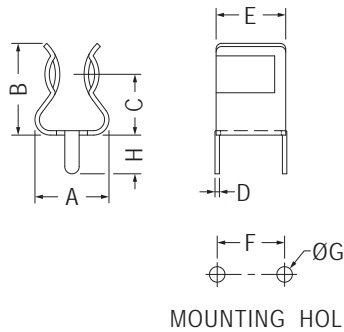
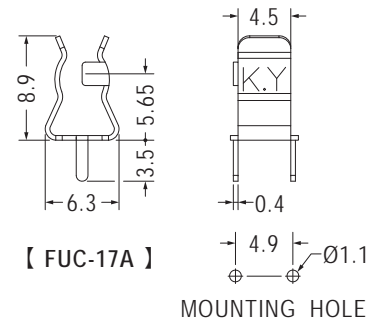
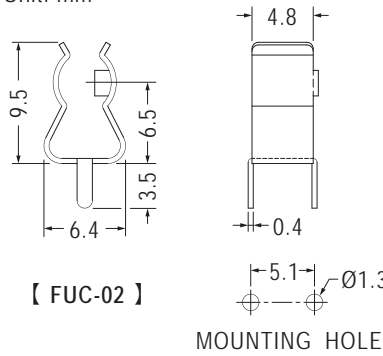

Part No.	A	B	C	D	E	F	G	H	適用保險絲 Cartridge Fuse	Package
FUC-03	6.8	8.3	5.5	0.4	6.3	6.0	1.4	3.6	Ø5.2	1000
FUC-03A	6.4	8.8	5.5	0.5	6.3	6.7	1.7	3.6	Ø5.2	
FUC-04	8.1	10.9	6.8	0.5	7.0	7.5	1.7	3.5	Ø6.3	
FUC-14	8.1	10.9	6.8	0.5	7.0	7.5	1.7	1.0	Ø6.3	



- Material: Nickel Plated Phosphor Bronze
- Unit: mm

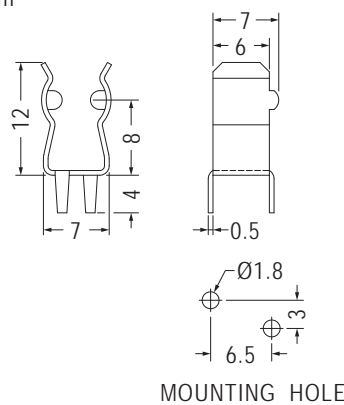

Part No.	適用保險絲 Cartridge Fuse	Package
FUC-09	Ø5.2	1000

保險絲座 FUSE HOLDER

用途：將保險絲固定於板座上，拆裝方便。

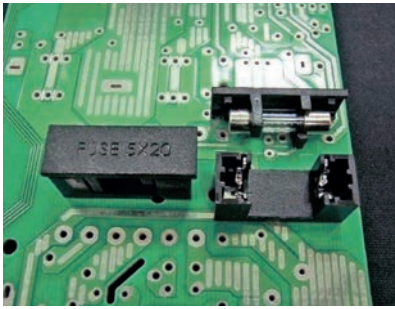

- Material: Nylon 66 (UL)
- Flame Class: 94V-2/94V-0
- Pin Material: Tin Plated Brass
- Color: Black
- Unit: mm

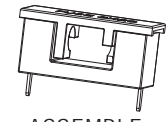
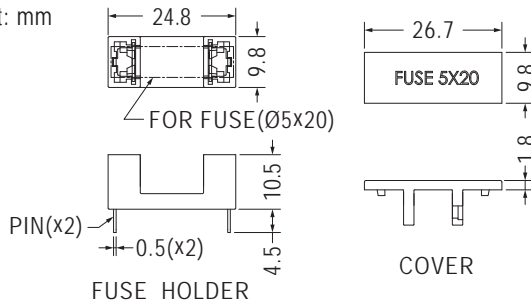

ASSEMBLE

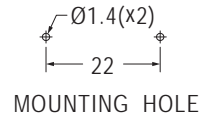

MOUNTING HOLE

Part No.	Package
FUSEC-1	200

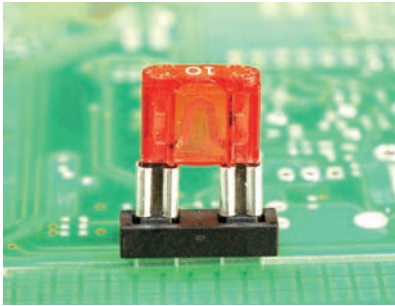

- Body Material: Nylon 66 (UL)
- Flame Class: 94V-2/94V-0
- Terminal Material: Tin Plated Brass
- Color: Natural/Black
- Unit: mm

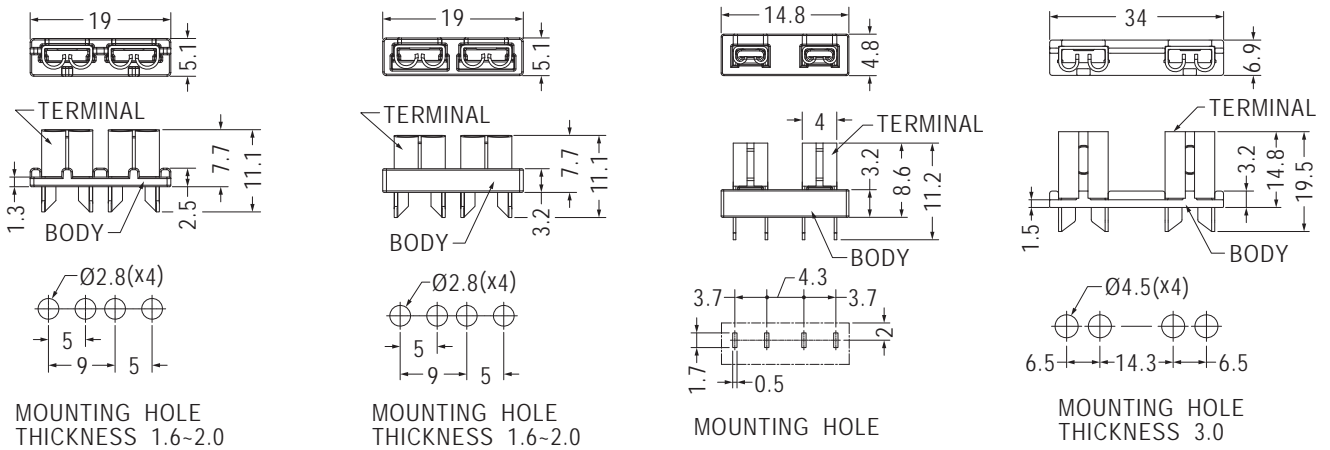

Part No.	Package
FUSCV-6F	1000

Part No.	Package
FUSCV-7F	1000

Part No.	Package
FUSCV-8F	1000

Part No.	Package
FUSCV-12F	1000

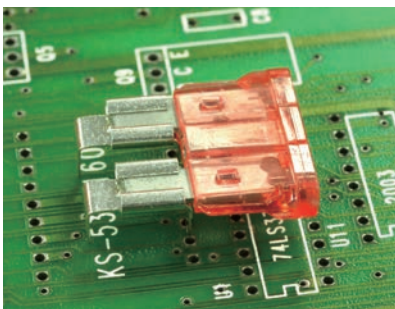

- Material: Bright Tin Plated Brass
- Unit: mm

用途：用於汽車保險絲。

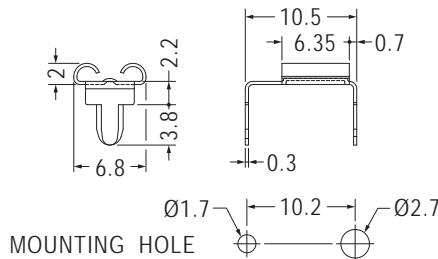

Part No.	Package
FUC-5A	1000

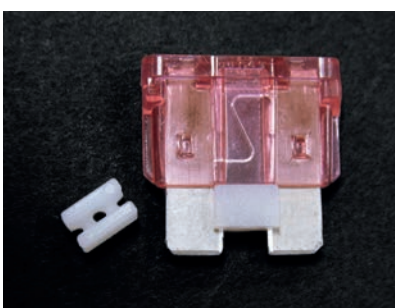

- Material: Nylon 66 (UL)
- Flame Class: 94V-2/94V-0
- Color: Natural/Black
- Unit: mm

用途：用於汽車保險絲之間隔、墊高作用。

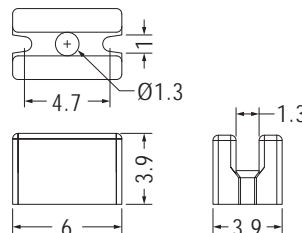

Part No.	Package
FUA-1	2000

PC板焊接端子 PCB TERMINAL

用途：PC板上之焊接電線端子，耐大電流，配合螺絲固定端子。

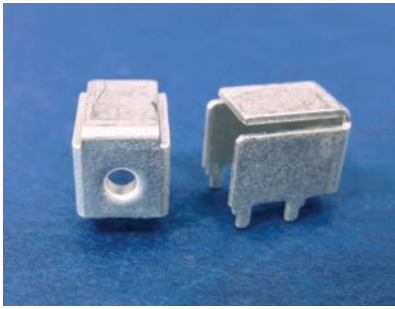

- Material: Tin Plated Brass
- Suggested Current: 15 Amps
- Unit: mm

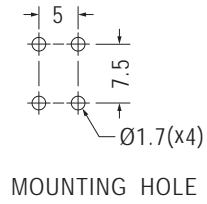
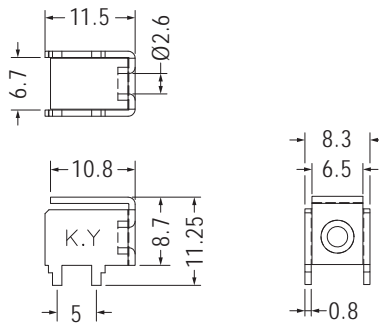

Part No.	Package
PCB-34	1000

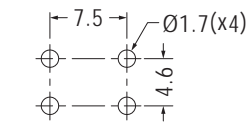
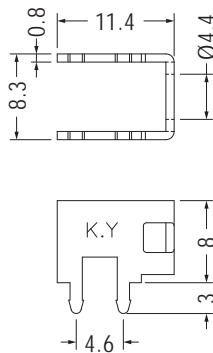
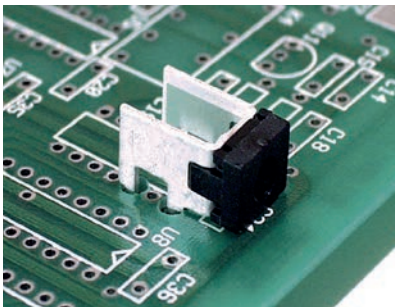

MOUNTING HOLE

Part No.	Package
PCB-21(4.4)	1000
組合件 (ASSY)	
PCB-21(4.4)F	PCB-21(4.4)+PCB-4CV

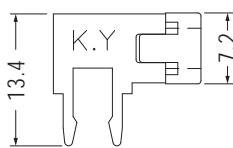
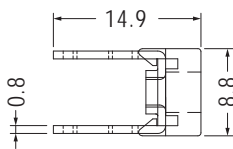

【 PCB-4F 】

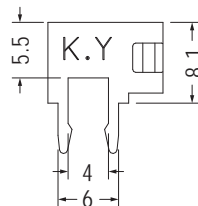
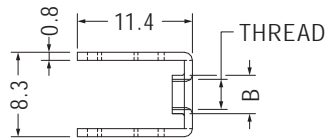

【 PCB-4 】

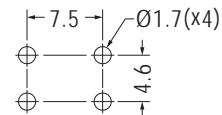

MOUNTING HOLE

Part No.	B	Thread	Package
PCB-4	3.5	M3x0.5P	1000
PCB-4(M4)	4.4	M4x0.7P	
PCB-4(632)	4.4	6-32 UNC	
組合件 (ASSY)			
PCB-4(M3)F	PCB-4+PCB-4CV		
PCB-4(M4)F	PCB-4(M4)+PCB-4CV		
PCB-4(632)F	PCB-4(632)+PCB-4CV		

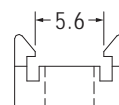
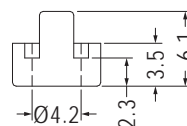
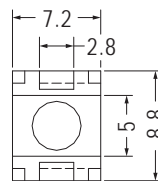

- Material: Nylon 66 (UL)
- Flame Class: 94V-2
- Color: Black

Part No.	Package
PCB-4CV	1000

PC板焊接端子 PCB TERMINAL

用途：PC板上之焊接電線端子，耐大電流，配合螺絲固定端子。

- Material: Tin Plated Brass
- Suggested Current: 15 Amps
- Unit: mm

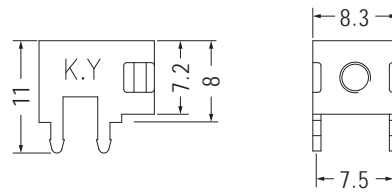
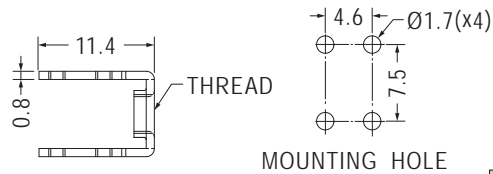
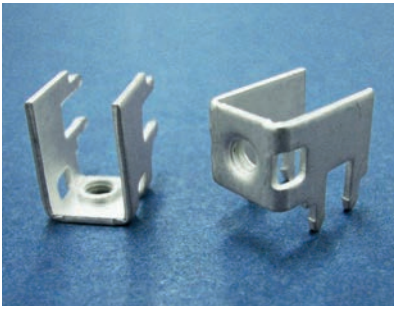

Part No.	Thread	Package
PCB-12	M3x0.5P	1000
PCB-12(M4)	M4x0.7P	
PCB-12(632)	6-32 UNC	

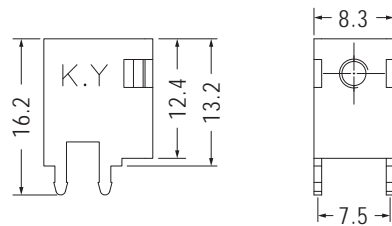
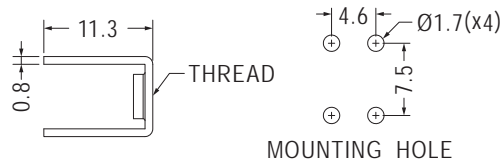
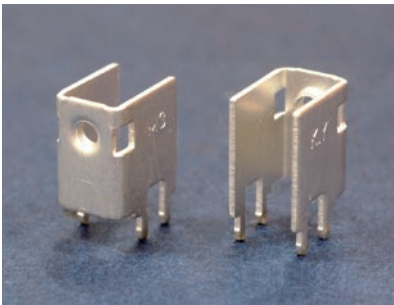

Part No.	Thread	Package
PCB-102	M3x0.5P	1000
★PCB-102(M4)	M4x0.7P	

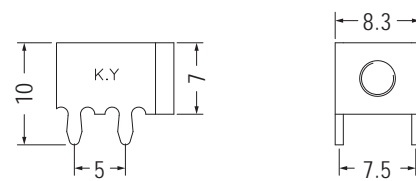
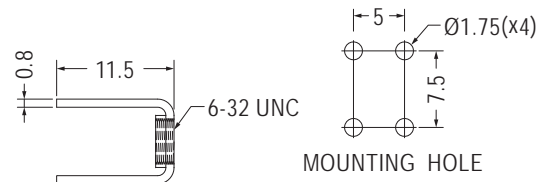

Part No.	Package
PCB-70	1000

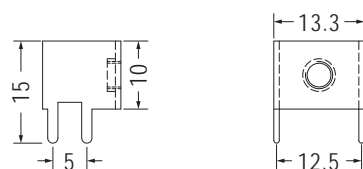
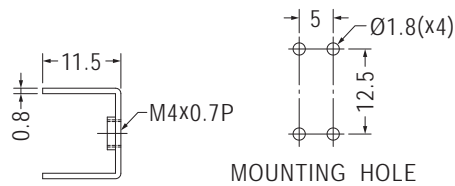
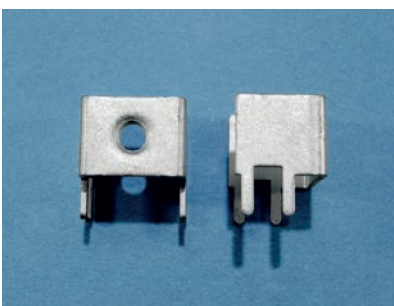

Part No.	Package
PCB-15(M4)	1000

PC板焊接端子 PCB TERMINAL

用途：PC板上之焊接電線端子，耐大電流，配合螺絲固定端子。

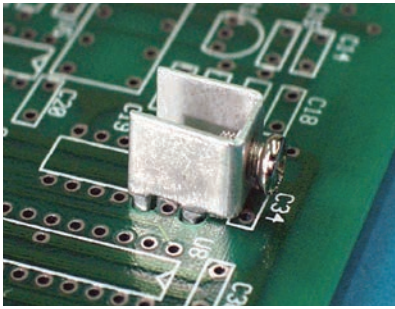

- Material: Tin Plated Brass
- Suggested Current: 15 Amps
- Unit: mm

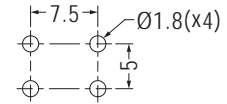
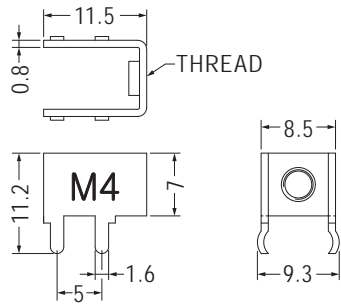

MOUNTING HOLE

Part No.	Thread	Package
PCB-2	M3x0.5P	1000
PCB-2(M4)	M4x0.7P	
PCB-2(6-32)	6-32 UNC	

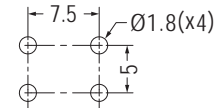
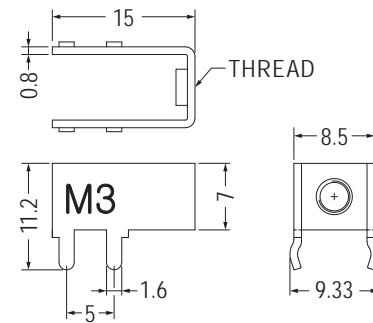

MOUNTING HOLE

Part No.	Thread	Package
PCB-78	M3x0.5P	1000
★PCB-78(M4)	M4x0.7P	

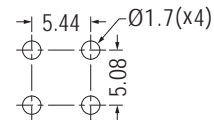
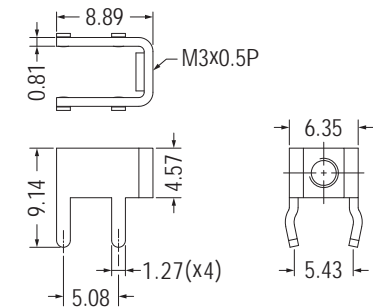

MOUNTING HOLE

Part No.	Package
PCB-128	1000

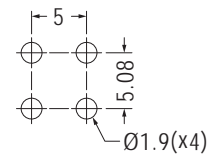
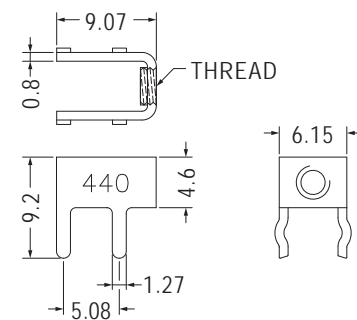

MOUNTING HOLE

Part No.	Thread	Package
★PCB-47ST(M3)	M3x0.5P	1000
PCB-47ST(440)	4-40 UNC	

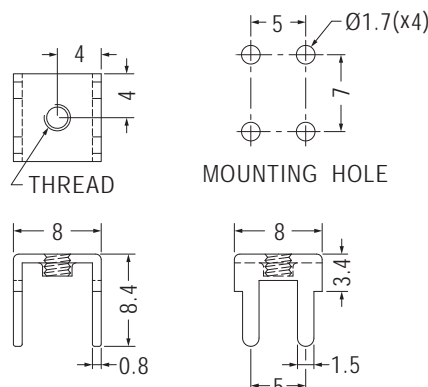

MOUNTING HOLE

Part No.	Thread	Package
PCB-1	M3x0.5P	1000
PCB-1(M4)	M4x0.7P	
PCB-1(6-32)	6-32 UNC	

PC板焊接端子 PCB TERMINAL

用途：PC板上之焊接電線端子，耐大電流，配合螺絲固定端子。



- Material: Tin Plated Brass
- Suggested Current: 15 Amps
- Unit: mm

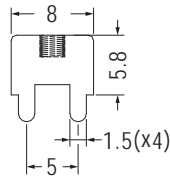
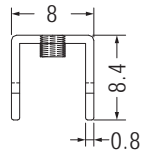
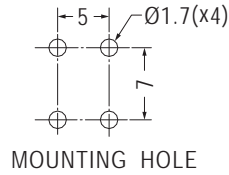
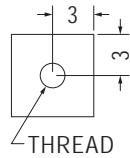
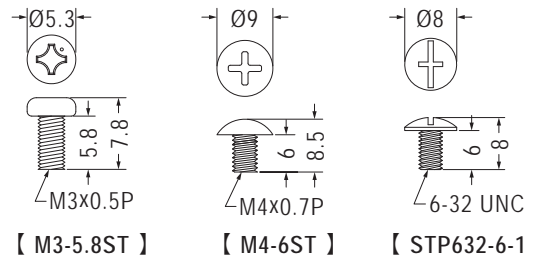

Part No.	Thread	Package
PCB-11	M3x0.5P	1000
PCB-11(M3.5)	M3.5x0.6P	
PCB-11(M4)	M4x0.7P	
PCB-11(632)	6-32 UNC	
組合作件 (ASSY)		
PCB-11M3-5.8F	PCB-11+M3-5.8ST	
PCB-11M4-6F	PCB-11(M4)+M4-6ST	
PCB-11(632)F	PCB-11(632)+STP632-6-1	

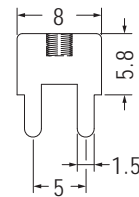
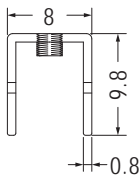
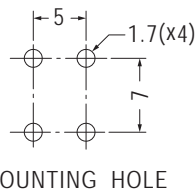
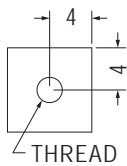
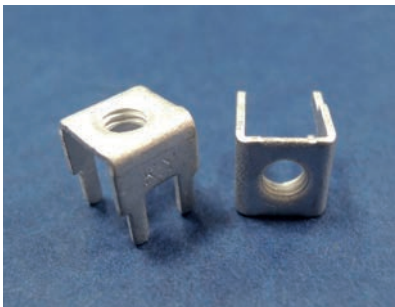

Part No.	Thread	Package
★ PCB-66(M3)	M3x0.5P	1000
PCB-66(M4)	M4x0.7P	

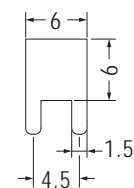
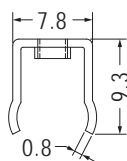
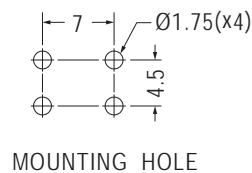
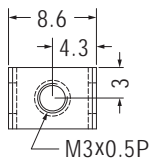

Part No.	Package
PCB-17	1000

PC板焊接端子 PCB TERMINAL

用途：PC板上之焊接電線端子，耐大電流，配合螺絲固定端子。

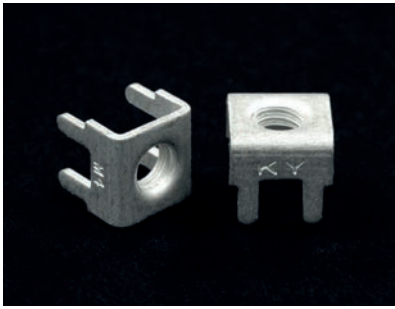

- Material: Tin Plated Brass
- Suggested Current: 15 Amps
- Unit: mm

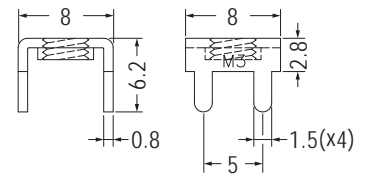
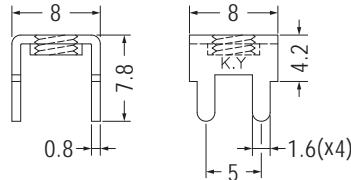
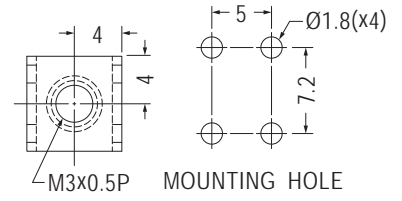
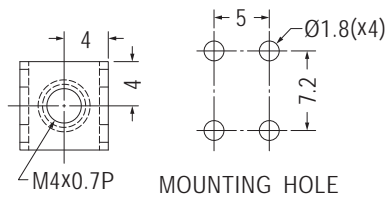

Part No.	Package
PCB-71	1000

Part No.	Package
PCB-75	1000

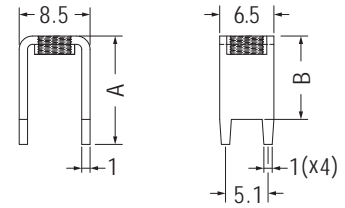
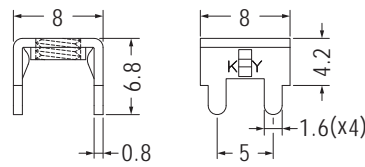
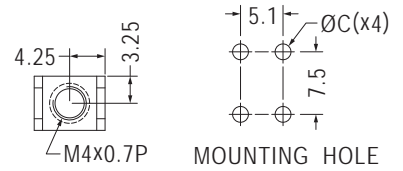
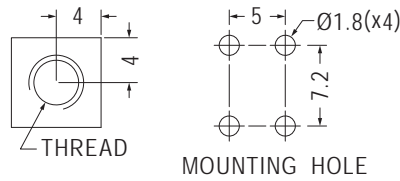

Part No.	Thread	Package
PCB-9-1	M3x0.5P	1000
PCB-9-1(M4)	M4x0.7P	
PCB-9-1(632)	6-32 UNC	

Part No.	A	B	C	Package
PCB-37M4	8.0	5.0	1.7	1000
PCB-58M4	13.0	10.0	1.9	

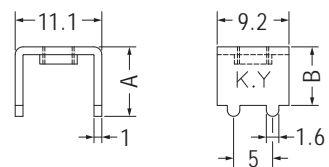
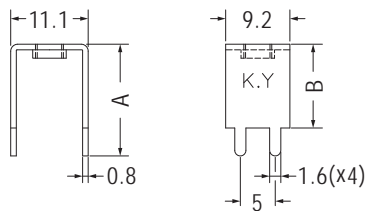
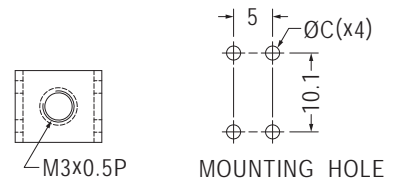
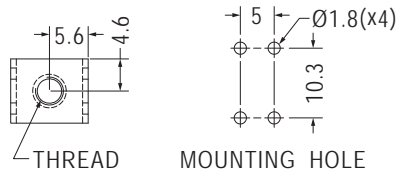

Part No.	A	B	Thread	Package
PCB-27(M3)	16.0	12.0	M3x0.5P	1000
PCB-27(M4)	16.0	12.0	M4x0.7P	
PCB-28(M3)	18.8	14.8	M3x0.5P	
PCB-28(M4)	18.8	14.8	M4x0.7P	

Part No.	A	B	C	Package
PCB-18	8.9	7.5	1.8	1000
PCB-106	22.25	18.25	1.9	500

PC板焊接端子 PCB TERMINAL

用途：PC板上之焊接電線端子，耐大電流，配合螺絲固定端子。



- Material: Tin Plated Brass
- Suggested Current: 20 Amps
- Unit: mm

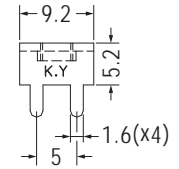
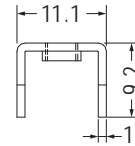
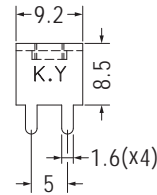
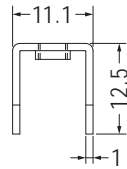
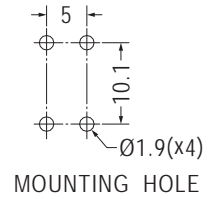
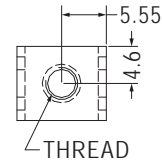
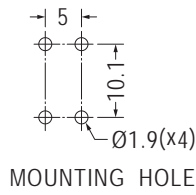
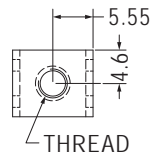

Part No.	Thread	Package
PCB-7	M3x0.5P	1000
PCB-7(M4)	M4x0.7P	
PCB-7(632)	6-32 UNC	

Part No.	Thread	Package
PCB-8	M3x0.5P	1000
PCB-8(M4)	M4x0.7P	
PCB-8(632)	6-32 UNC	

PC板焊接端子加螺絲(附四角華司) PCB TERMINAL

用途：PC板上之焊接電線端子，耐大電流，配合螺絲固定端子。



- Material: Tin Plated Brass
- Suggested Current: 15 Amps
- Unit: mm

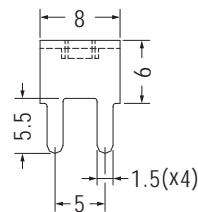
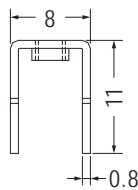
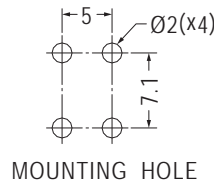
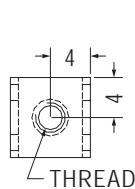

Part No.	Thread	Package
PCB-10A(M3)	M3x0.5P	1000
PCB-10A	M3.5x0.6P	
PCB-10AM4	M4x0.7P	
PCB-10A(632)	6-32 UNC	

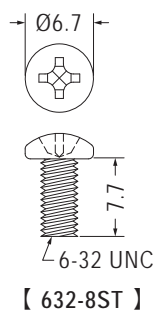
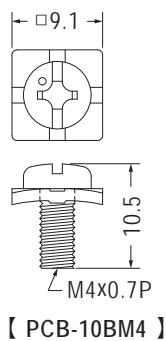
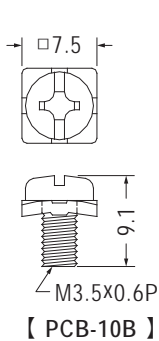

組套件 (ASSY)	
PCB-10	PCB-10A+PCB-10B
PCB-10M4F	PCB-10AM4+PCB-10BM4
PCB-10(632)F	PCB-10A(632)+632-8ST

PC板焊接端子 PCB TERMINAL

用途：PC板上之焊接電線端子，耐大電流，配合螺絲固定端子。

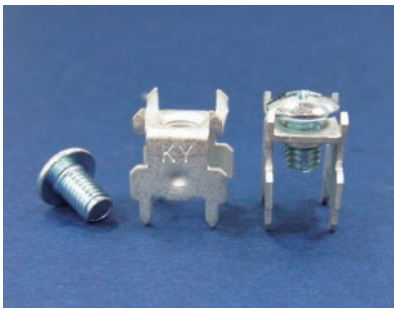

- Material: Tin Plated Brass
- Suggested Current: 20 Amps
- Unit: mm

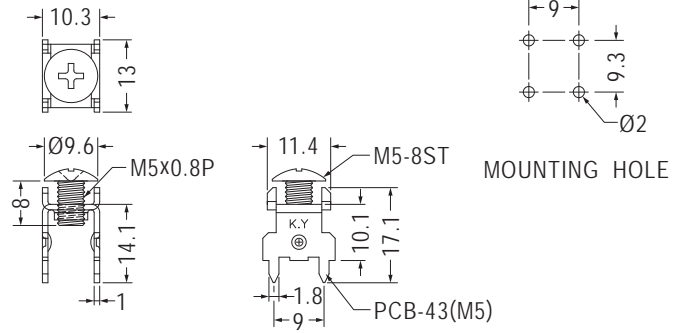

Part No.	組零件 (ASSY)	Package
PCB-43(M5)F	PCB-43(M5)+M5-8ST	500



- Material: Tin Plated Brass
- Suggested Current: 30 Amps
- Unit: mm

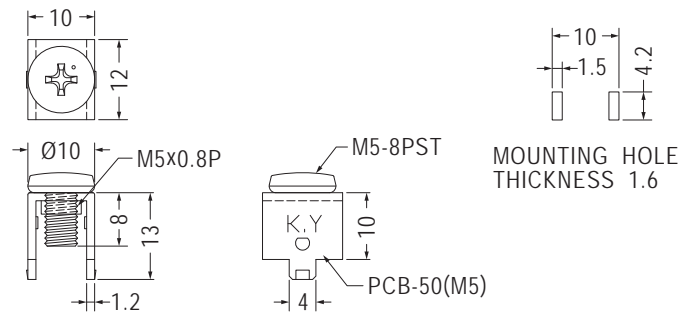

Part No.	組零件 (ASSY)	Package
PCB-50M5F	PCB-50(M5)+M5-8PST	500



- Material: Tin Plated Brass
- Suggested Current: 15 Amps
- Unit: mm

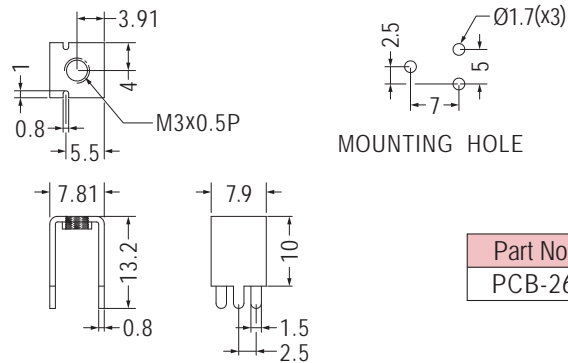

Part No.	Package
PCB-26	1000



- Material: Tin Plated SPCC
- Suggested Current: 15 Amps
- Unit: mm

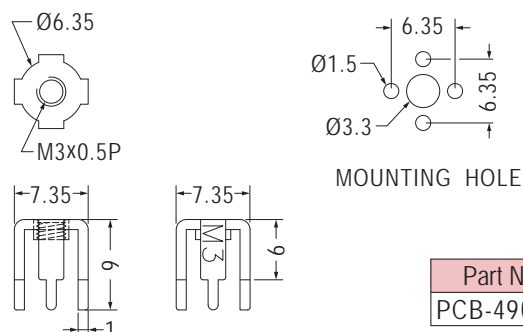

Part No.	Package
PCB-49(M3)	1000

PC板焊接端子 PCB TERMINAL

用途：PC板上之焊接電線端子，耐大電流，配合螺絲固定端子。

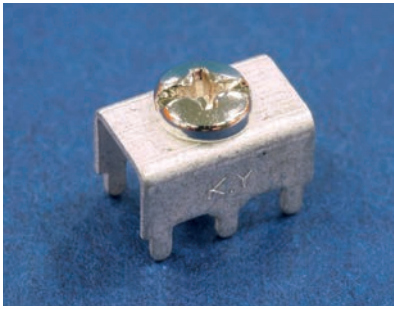

- Terminal Material: Tin Plated Brass
- Screw Material: Nickel Plated Steel
- Suggested Current: 30 Amps
- Unit: mm

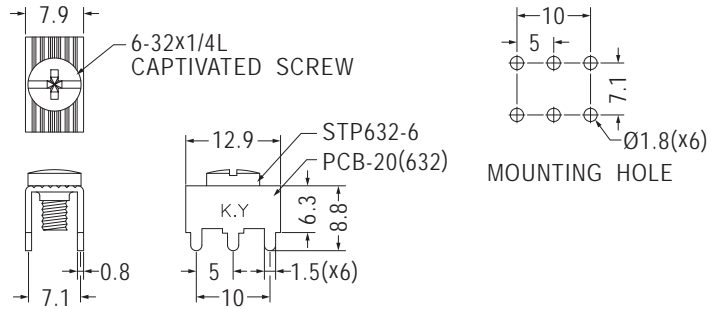

Part No.	組合作件(ASSY)	Package
PCB-20(632)F	PCB-20(632)+STP632-6	1000

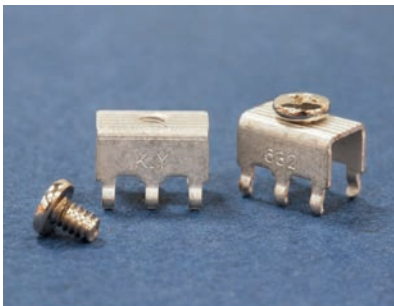

- Material: Tin Plated Brass
- Suggested Current: 30 Amps
- Unit: mm

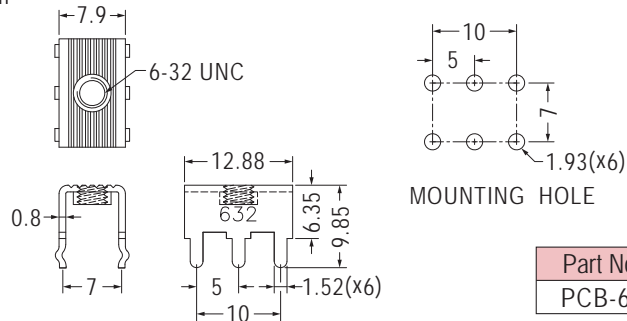

Part No.	Package
PCB-60	1000

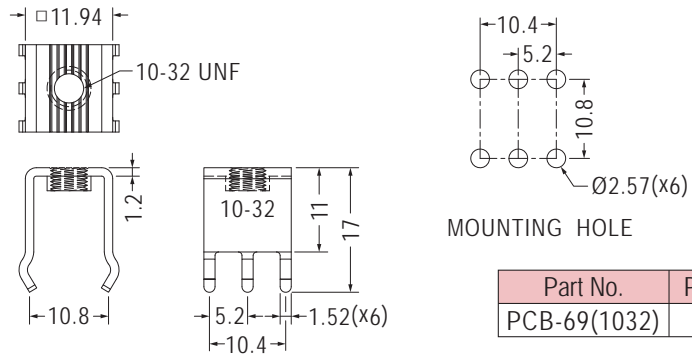
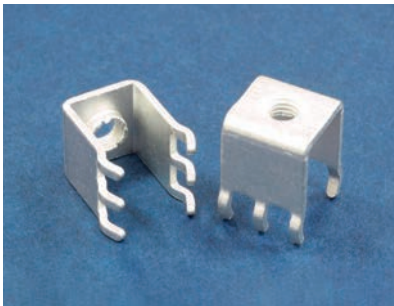

Part No.	Package
PCB-69(1032)	1000

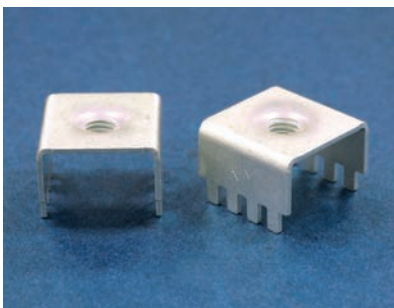

- Material: Tin Plated Copper
- Suggested Current: 50 Amps
- Unit: mm

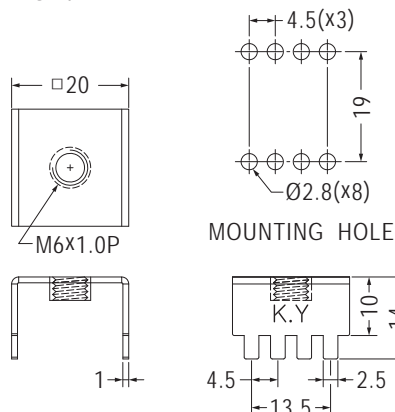

Part No.	Package
PCB-82	250

- Material: Tin Plated Copper
- Suggested Current: 125 Amps
- Unit: mm

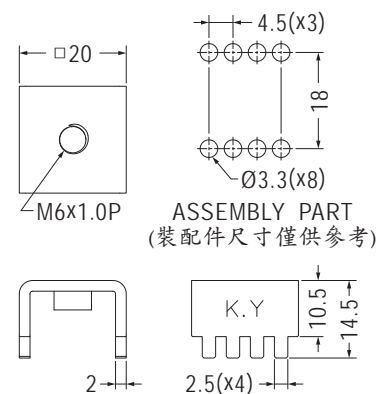

Part No.	Package
PCB-82-1	250

PC板焊接端子 PCB TERMINAL

用途：焊接於PC板上，另一端插接端子。



- Material: Tin Plated Brass
- Suggested Current: 15 Amps
- Unit: mm

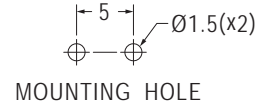
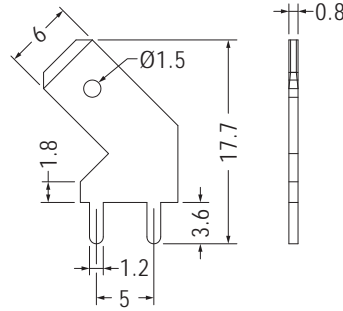

Part No.	Package
PCRL250	1000



- Material: Tin Plated Brass
- Unit: mm

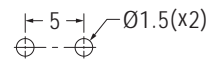
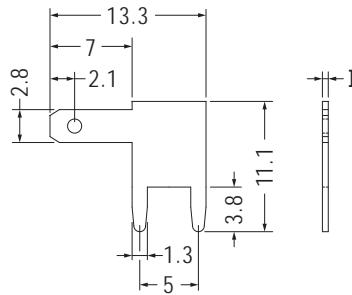

MOUNTING HOLE

Part No.	I	Suggested Current	Package
PCF110	0.5	10 Amps	1000
PCF1108	0.8	15 Amps	

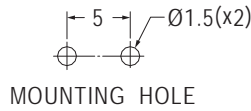
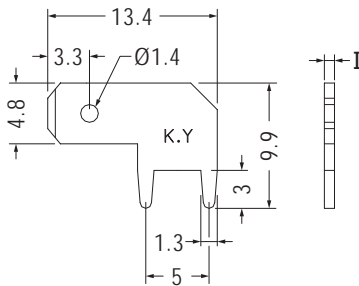

MOUNTING HOLE

Part No.	I	Suggested Current	Package
PCF187(5)	0.5	10 Amps	1000
PCF187	0.8	15 Amps	



- Material: Tin Plated Brass
- Suggested Current: 15 Amps
- Unit: mm

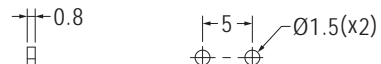
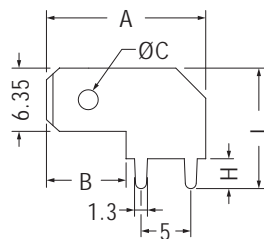

MOUNTING HOLE

Part No.	A	B	C	H	L	Package
PCF250	16.0	8.0	2.0	3.0	12.1	1000
PCF250-11	20.0	12.3	1.7	3.8	12.7	

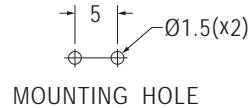
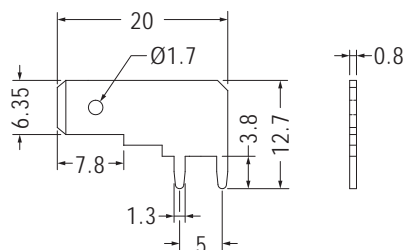

MOUNTING HOLE

Part No.	Package
PCFL250	1000

PC板焊接端子 PCB TERMINAL

用途：PC板上之插接電線端子，美觀、牢固、耐電流大，配合螺絲固定端子。

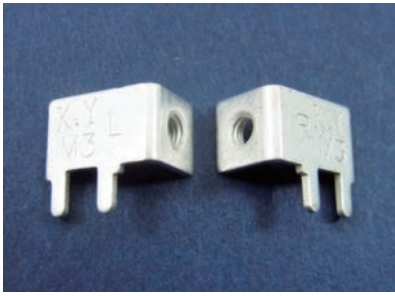

- Material: Tin Plated Brass
- Suggested Current: 15 Amps
- Unit: mm

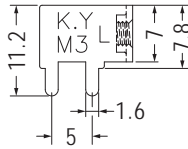
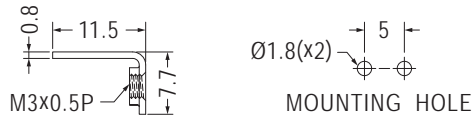

Part No.	Package
PCB-54L(M3)	1000

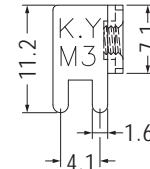
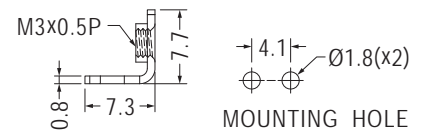
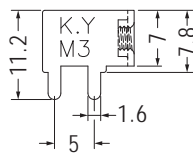
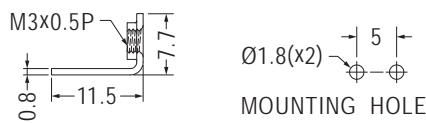
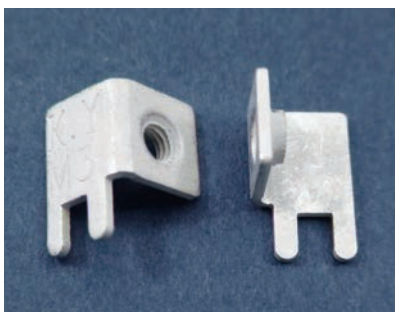

Part No.	Package
PCB-54R(M3)	1000

Part No.	Package
PCB-55(M3)	1000

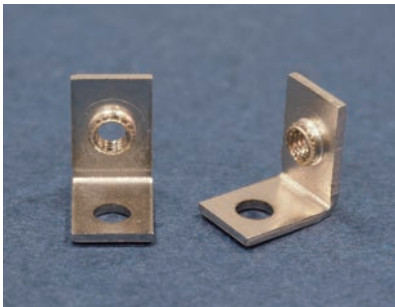

- Material: Nickel Plated Steel
- Unit: mm

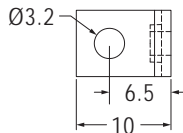
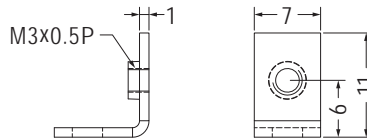

Part No.	Package
PCB-99	1000

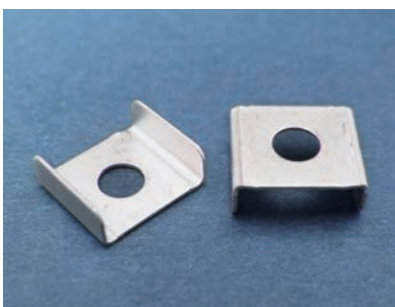

- Material: Tin Plated Brass
- Unit: mm

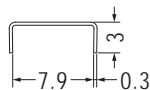
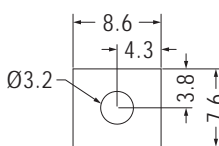

Part No.	Package
PCB-25(3.2)	1000

PC板焊接端子 PCB TERMINAL

用途：PC板上之焊接電線端子，美觀、牢固、耐電流大，配合螺絲固定端子。

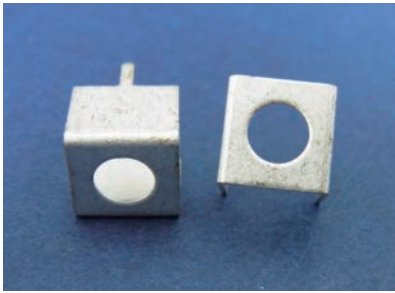

- Material: Tin Plated Brass
- Suggested Current: 10 Amps
- Unit: mm

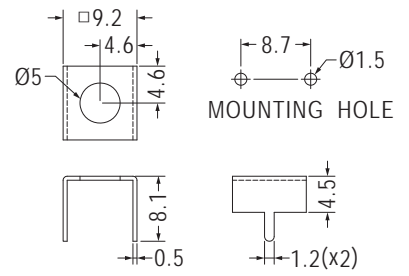
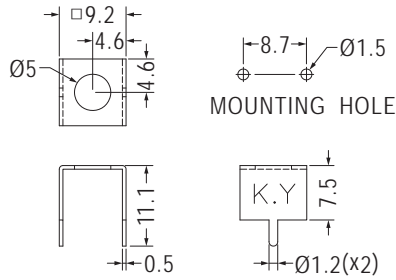

Part No.	Package
PCB-29	1000

Part No.	Package
PCB-44	1000

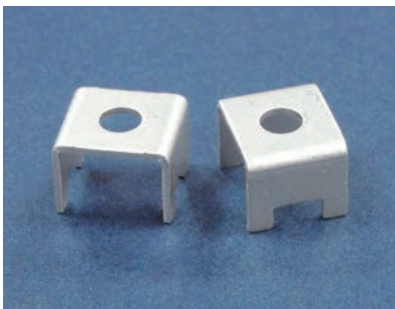

- Material: Tin Plated Brass
- Suggested Current: 30 Amps
- Unit: mm

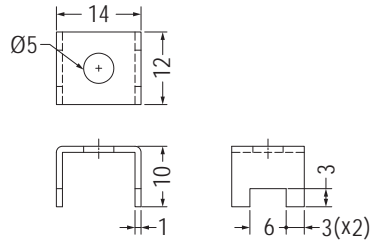

Part No.	Package
PCB-77	1000



- Material: Tin Plated Phosphor Bronze
- Suggested Current: 30 Amps
- Unit: mm

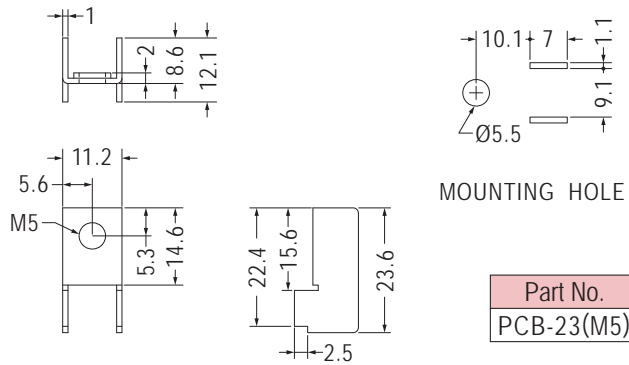

Part No.	Package
PCB-23(M5)	1000

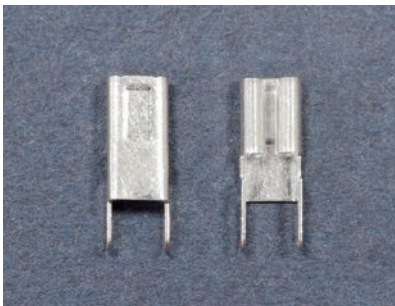

- Material: Tin Plated Brass
- Suggested Current: 10 Amps
- Unit: mm

用途：PC板上之焊接電線端子或汽車保險絲，耐電流大。

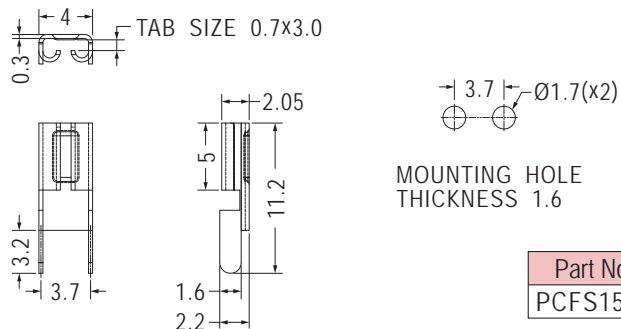

Part No.	Package
PCFS156A	1000

PC板焊接端子 PCB TERMINAL

用途：焊接於PC板上，另一端插接公端，耐電流大。

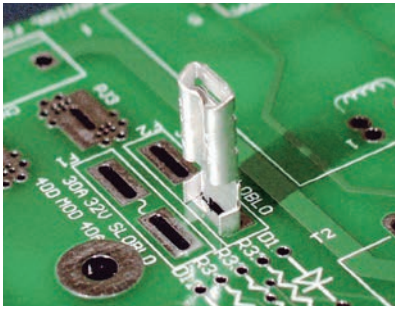

- Material: Tin Plated Brass
- Suggested Current: 10 Amps @ 500V AC
- Unit: mm

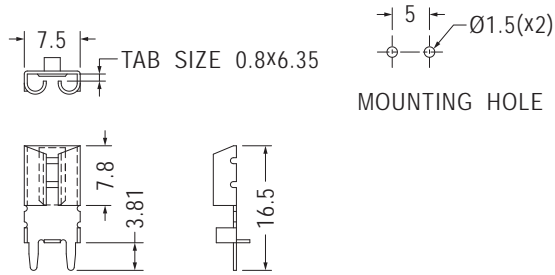

Part No.	Package
PCFS250L	1000



- Material: Tin Plated Brass
- Suggested Current: 10 Amps @ 500V AC
- Unit: mm

用途：PC板上之焊接電線端子或汽車保險絲，耐電流大。

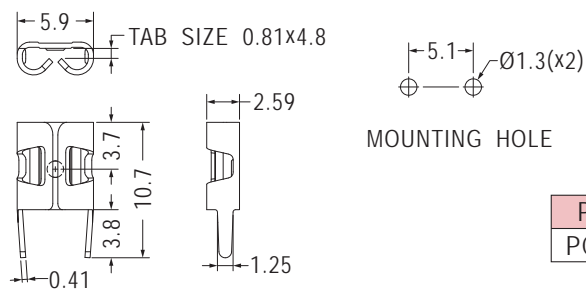

Part No.	Package
PCFS187	1000



- Material: Bright Tin Plated Brass
- Suggested Current: 30 Amps @ 500V AC
- Unit: mm

用途：PC板上之焊接電線端子或汽車保險絲，耐電流大。

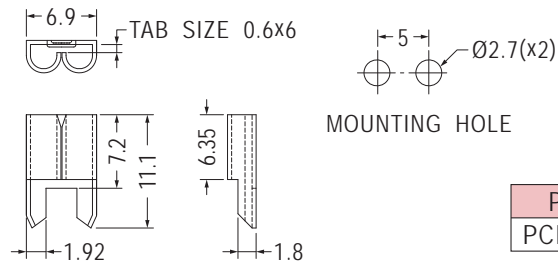

Part No.	Package
PCFS2509A	1000



- Material: Tin Plated Brass
- Suggested Current: 30 Amps @ 500V AC
- Unit: mm

用途：PC板上之焊接電線端子或汽車保險絲，耐電流大。

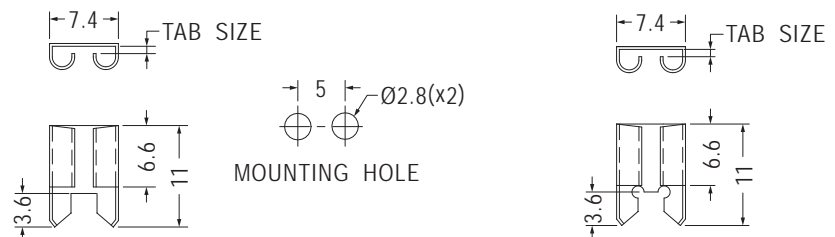

Part No.	Tab Size	Package
PCFS2505	0.5x6.35	1000
PCFS2508	0.8x6.35	

Part No.	Tab Size	Package
PCFS2505A	0.5x6.35	1000
PCFS2508A	0.8x6.35	

PC板焊接端子 PCB TERMINAL

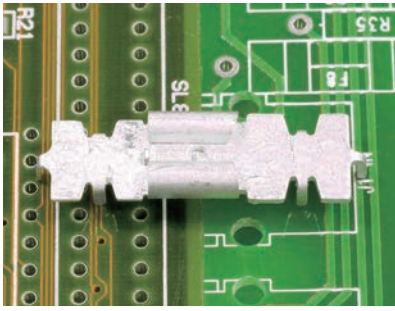

- Material: Tin Plated Brass
- Suggested Current: 10 Amps
- Unit: mm

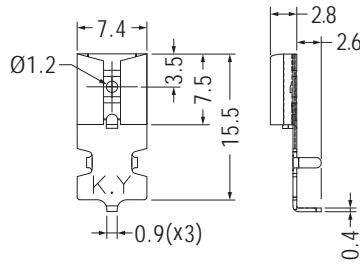

用途：兩個端子對接焊於PC板上，牢固，不動搖。

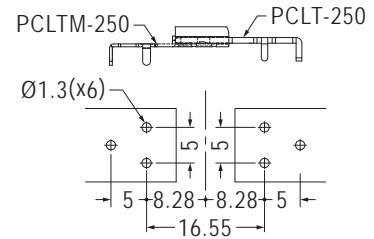

COMBINATION ILLUSTRATION DWG MOUNTING HOLE

Part No.	Package
PCLTM-250	1000

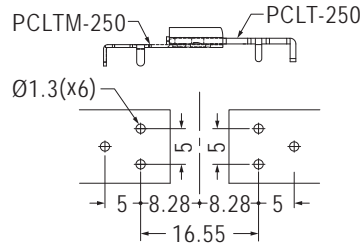
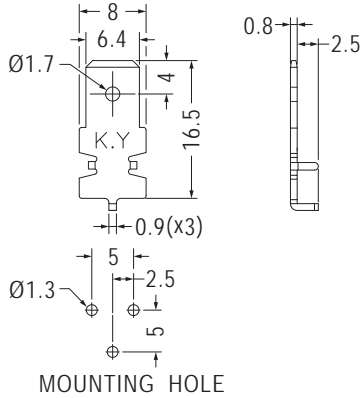

COMBINATION ILLUSTRATION DWG MOUNTING HOLE

Part No.	Package
PCLT-250	1000

焊接端子 PIN TERMINAL



- Material: Tin Plated Brass
- Suggested Current: 10 Amps
- Unit: mm

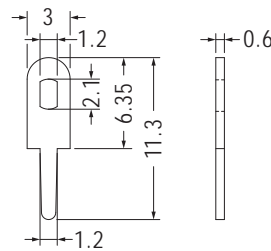

MOUNTING HOLE Ø1.2-Ø1.3

Part No.	Package
PIN-1	2000



- Material: Tin Plated Brass
- Suggested Current: 30 Amps
- Unit: mm

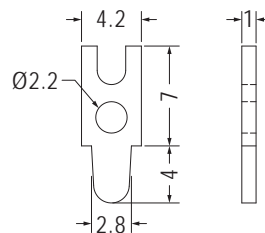

MOUNTING HOLE Ø3.0

Part No.	Package
PIN-2	2000



- Material: Nickel Plated Brass
- Suggested Current: 15 Amps
- Unit: mm

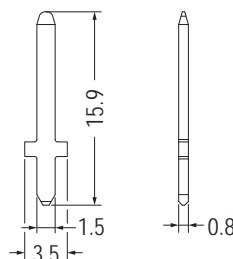

MOUNTING HOLE Ø1.7

Part No.	Package
PIN-9	2000

PC板焊接端子 PCB TERMINAL

用途：焊接於PC板上，另一端插接端子。



- Material: Tin Plated Brass
- Suggested Current: 10 Amps
- Unit: mm

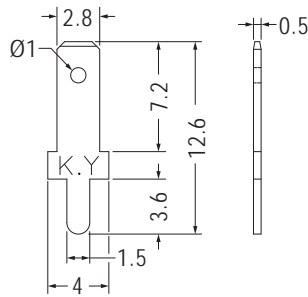

MOUNTING HOLE Ø1.7

Part No.	Package
PC110	2000



- Material: Nickel Plated Brass/Tin Plated Brass
- Suggested Current: 15 Amps
- Unit: mm

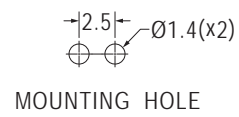
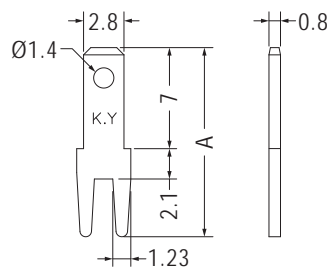

Part No.	A	Package
PC110-1	13.1	2000
PC110-4	12.1	



- Material: Tin Plated Brass
- Unit: mm

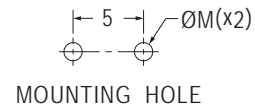
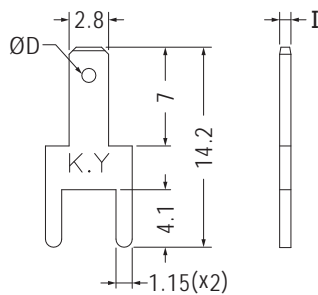

Part No.	D	I	M	Suggested Current	Package
PC110D5	1.0	0.5	1.3	10 Amps	2000
PC110D5-1	1.3	0.5	1.3	10 Amps	
PC110D8	0.8	0.8	1.5	15 Amps	

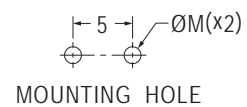
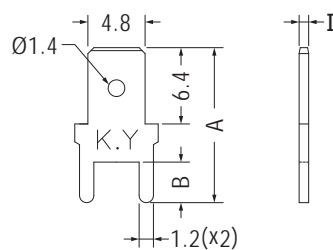

Part No.	A	B	I	M	Suggested Current	Package
PC187	13.0	3.4	0.5	1.4	10 Amps	2000
PC187(0.8)	13.0	3.4	0.8	1.5	15 Amps	
PC187-16-1	11.9	2.3	0.8	1.4	15 Amps	

PC板焊接端子 PCB TERMINAL

用途：焊接於PC板上，另一端插接端子。

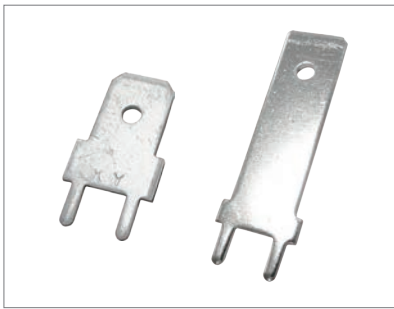

- Material: Tin Plated Brass
- Suggested Current: 15 Amps
- Unit: mm

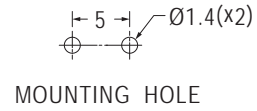
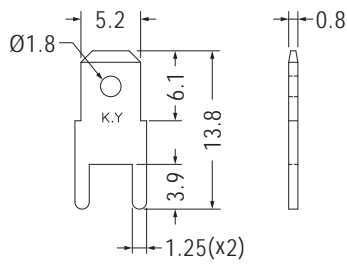

Part No.	Package
PC205	2000

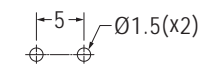
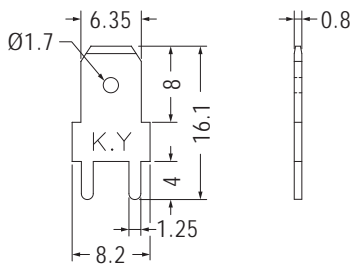

Part No.	Package
PC250	1000

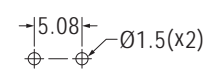
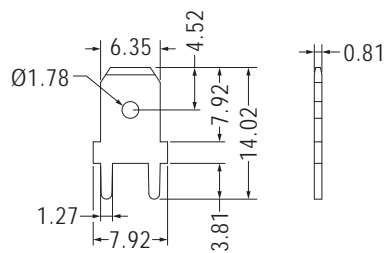

Part No.	Package
PC250-8	1000

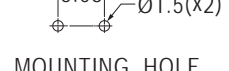
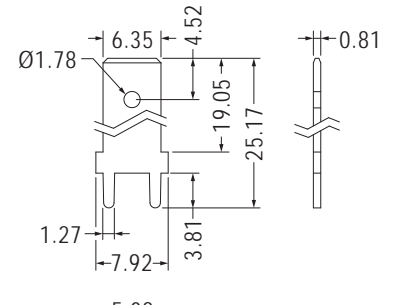

- Material: Nickel Plated Brass

Part No.	Package
PC250-4	1000

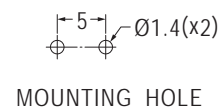
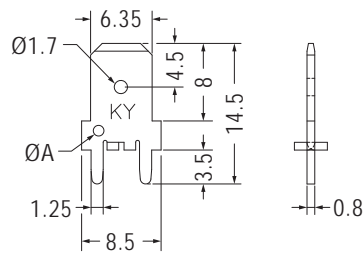
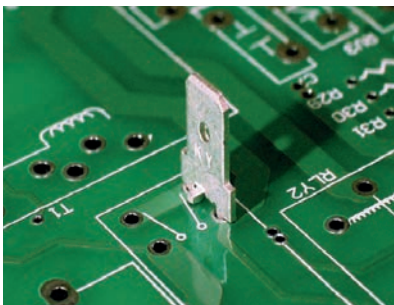

Part No.	A	Package
PCH250		1000
PCH250-1	1.1	

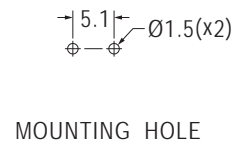
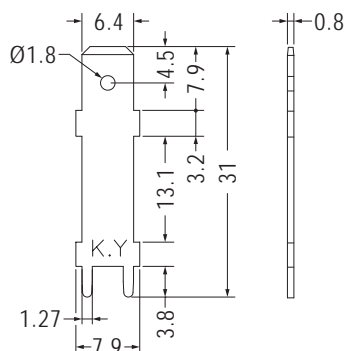
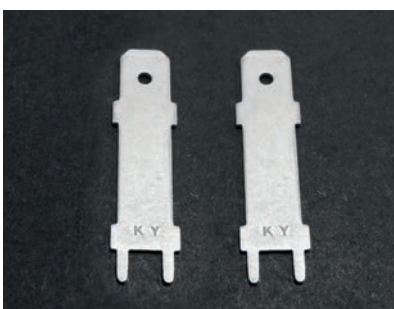

Part No.	Package
PC250-11	1000

PC板焊接端子 PCB TERMINAL

用途：焊接於PC板上，另一端插接端子。



- Material: Tin Plated Brass
- Suggested Current: 15 Amps
- Unit: mm

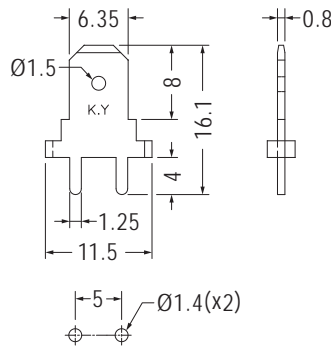

MOUNTING HOLE

Part No.	Package
PCR250	1000

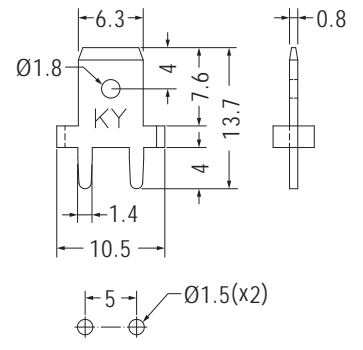

MOUNTING HOLE

Part No.	Package
PCR250-S	1000



- Material: Tin Plated Brass
- Suggested Current: 15 Amps
- Unit: mm

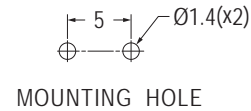
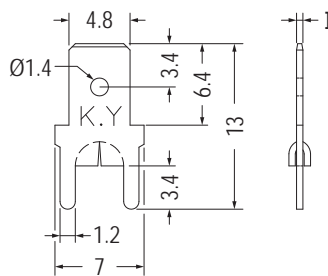

Part No.	I	Suggested Current	Package
PCR187	0.5	10 Amps	1000
PCR187(0.8)	0.8	15 Amps	

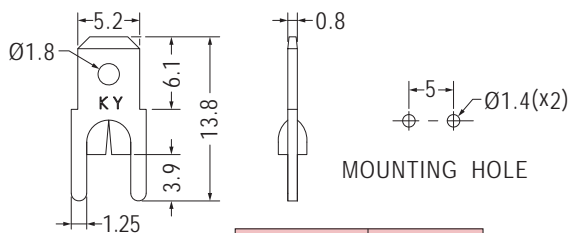

MOUNTING HOLE

Part No.	Package
PCRS205	1000

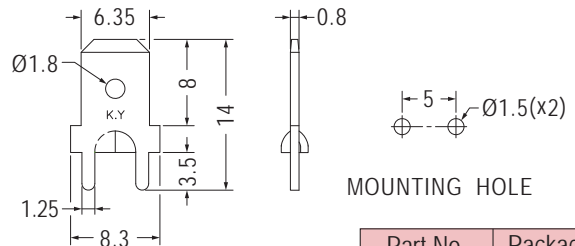

MOUNTING HOLE

Part No.	Package
PCRS250	1000

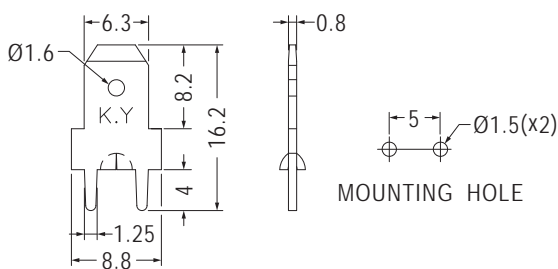

MOUNTING HOLE

Part No.	Package
PCRS250-1	1000

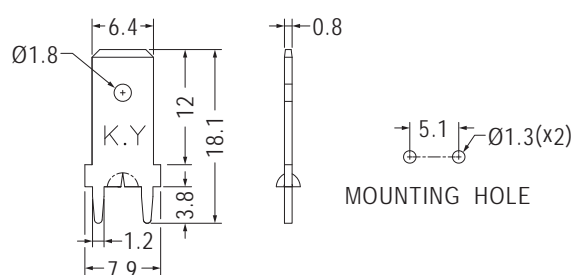

MOUNTING HOLE

Part No.	Package
PCRS250-2	1000

PC板焊接端子 PCB TERMINAL

用途：焊接於PC板上，另一端插接端子，牢固不動搖。



- Material: Tin Plated Brass
- Suggested Current: 15 Amps
- Unit: mm

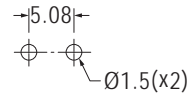
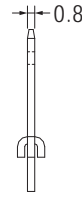
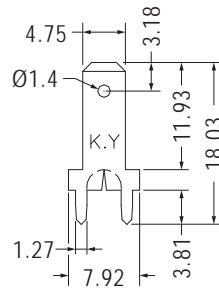

MOUNTING HOLE

Part No.	Package
PCRS187A	1000



- Material: Tin Plated Brass
- Suggested Current: 35 Amps
- Unit: mm

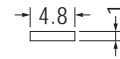
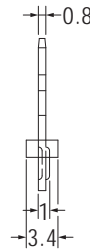
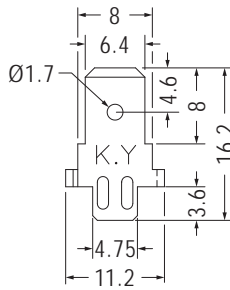

MOUNTING HOLE

Part No.	Package
PCRN250	1000

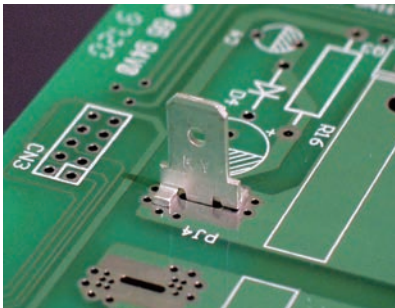

- Material: Tin Plated Brass
- Suggested Current: 25 Amps
- Unit: mm

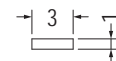
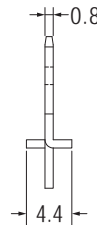
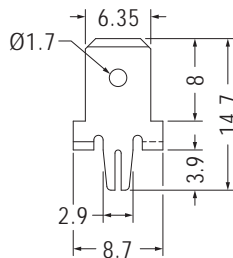

MOUNTING HOLE

Part No.	Package
PCK250	1000

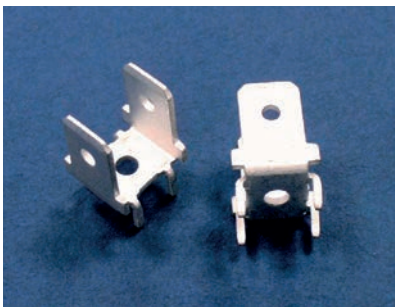

- Material: Tin Plated Brass
- Suggested Current: 20 Amps
- Unit: mm

用途：PC板上之焊接端子，美觀，牢固。

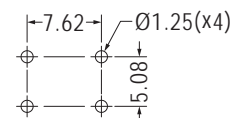
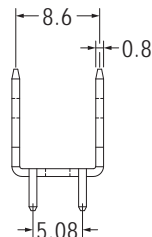
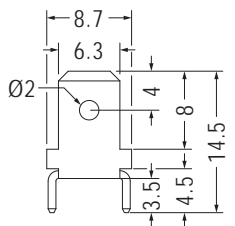

MOUNTING HOLE

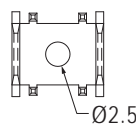

Part No.	Package
PCU250	1000

PC板焊接端子 PCB TERMINAL

用途：PC板上之焊接端子，美觀，牢固。

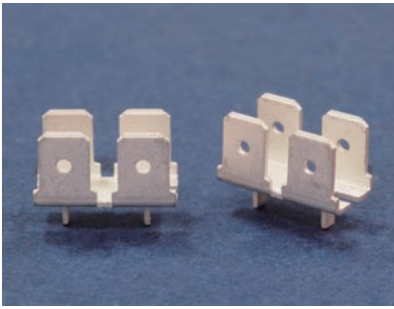

- Material: Tin Plated Brass
- Suggested Current: 20 Amps
- Unit: mm

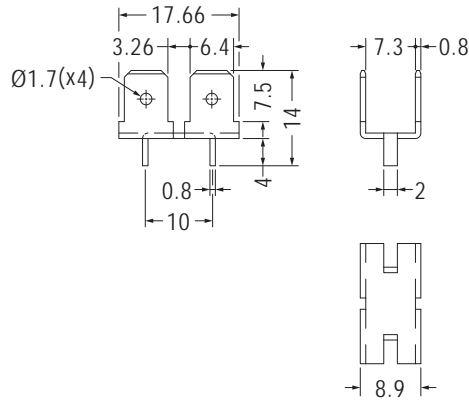

Part No.	Package
PCB-100	1000

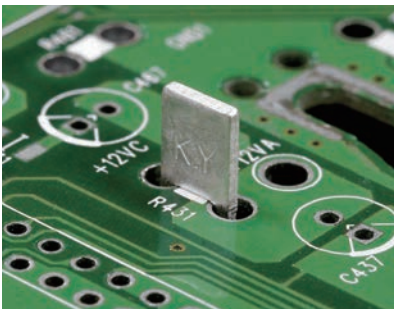

- Material: Tin Plated Brass
- Unit: mm

用途：焊接於PC板上，另一端插接端子。

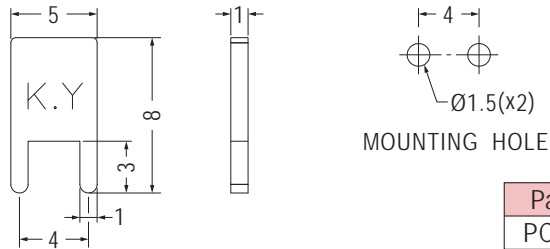

Part No.	Package
PCLTA-2	1000



- Material: Tin Plated Brass
- Unit: mm

用途：PC板上之焊接電線端子，耐大電流。

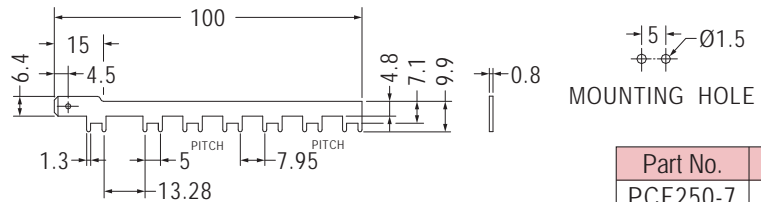

Part No.	Package
PCF250-7	500



- Material: Tin Plated Brass
- Suggested Current: 15 Amps
- Unit: mm

用途：PC板上之焊接電線端子，耐大電流。

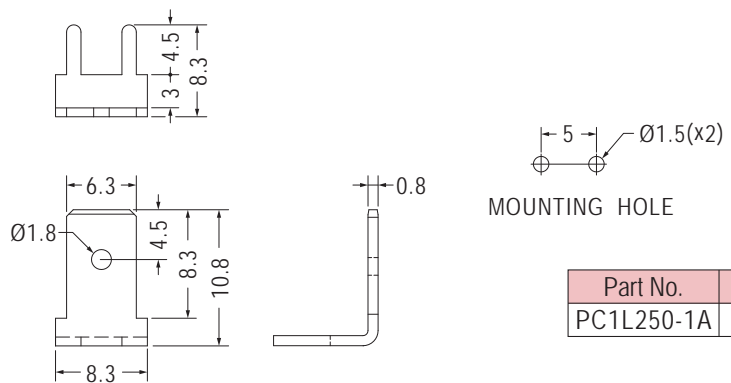

Part No.	Package
PC1L250-1A	1000

PC板焊接端子 PCB TERMINAL

用途：PC板上之焊接電線端子，耐大電流。



- Material: Tin Plated Brass
- Suggested Current: 15 Amps
- Unit: mm

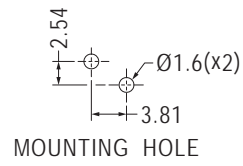
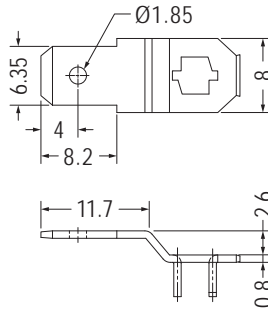

Part No.	Package
PC1L250-7	1000

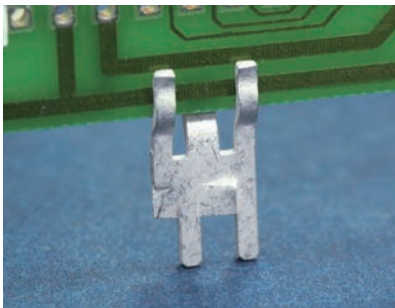

- Material: Tin Plated Brass
- Suggested Current: 5 Amps
- Unit: mm

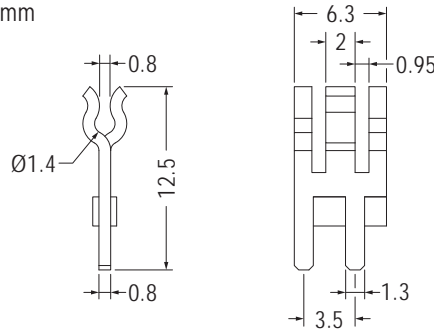

Part No.	Package
EM-408	1000



- Material: Tin Plated Brass
- Unit: mm

用途：可用螺絲鎖於PC板上，另一端插接端子。

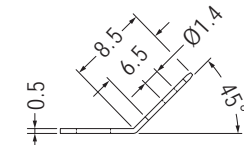
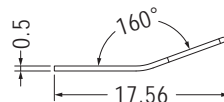
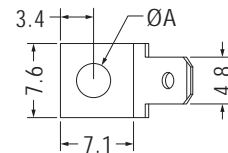
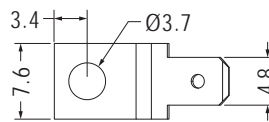

Part No.	Package
PC1V18706	1000

Part No.	A	Package
PC1V187	3.7	1000
PC1V18704	4.3	
PC1V18705	5.3	

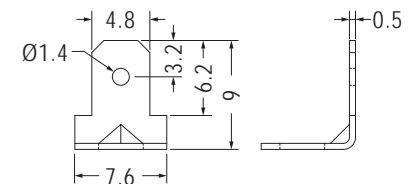
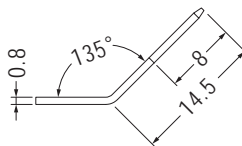
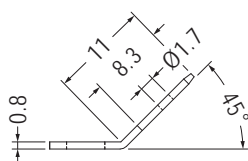
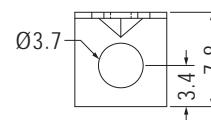
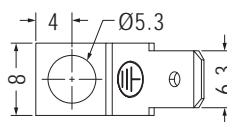
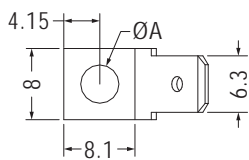

- Material: Nickel Plated Steel

Part No.	A	Package
PC1L250	4.3	1000
PC1L25005	5.3	

Part No.	Package
PC1L250-12	1000

Part No.	Package
PC1L187	1000

PC板端子 PCB TERMINAL

用途：可用螺絲鎖於PC板上，另一端插接端子。



- Material: Tin Plated Brass
- Unit: mm

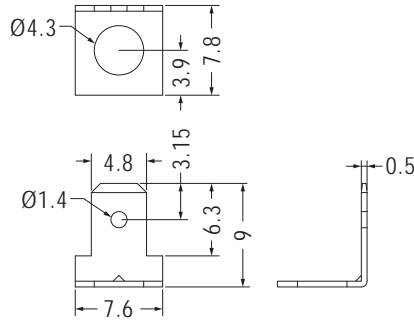

Part No.	Package
PC3L18704	1000

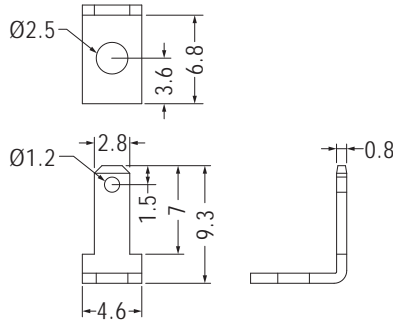

Part No.	Package
PC3L110028	1000

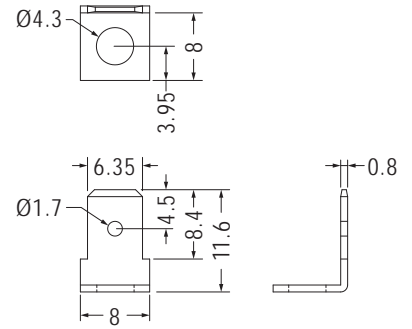

Part No.	Package
PC3L25004	1000

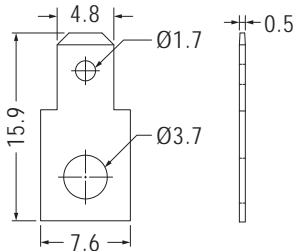

Part No.	Package
PC11187	1000

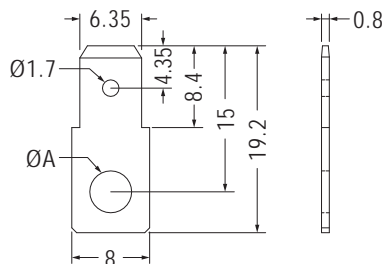

Part No.	A	Package
PC11250	4.3	1000
PC1125003	3.2	
PC1125035	3.5	
PC1125005	5.3	

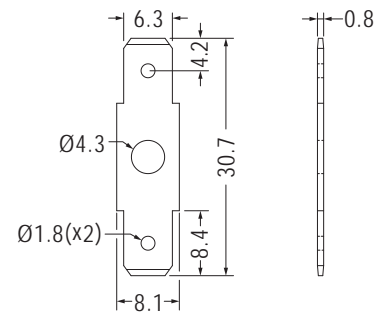

Part No.	Package
PC12250	1000

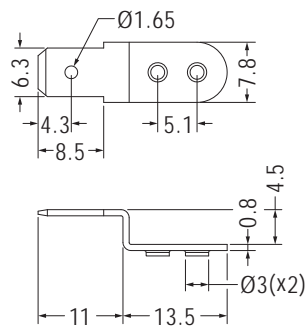

Part No.	Package
PC1L250-4	1000

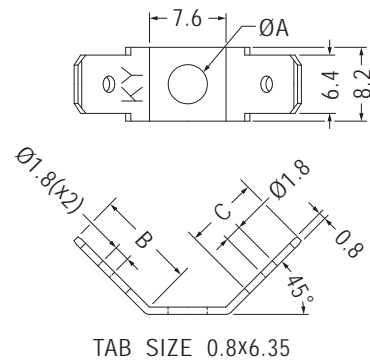

Part No.	A	B	C	Package
PC2L250	4.3	11.0	8.4	1000
PC2L25005	5.3	10.6	8.5	

PC板端子 PCB TERMINAL

用途：可用螺絲鎖於PC板上，另一端插接端子。



- Material: Tin Plated Brass
- Unit: mm

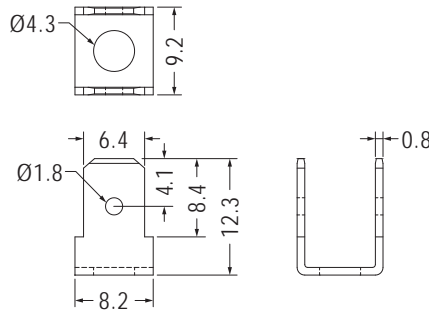

Part No.	Package
PC2L250-90	1000

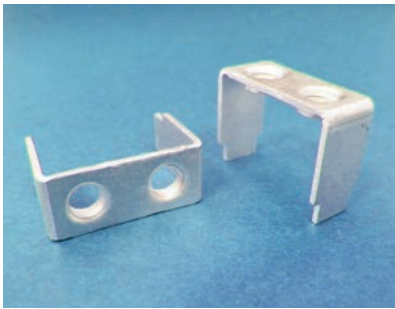

- Material: Tin Plated Phosphor Bronze
- Suggested Current: 25 Amps
- Unit: mm

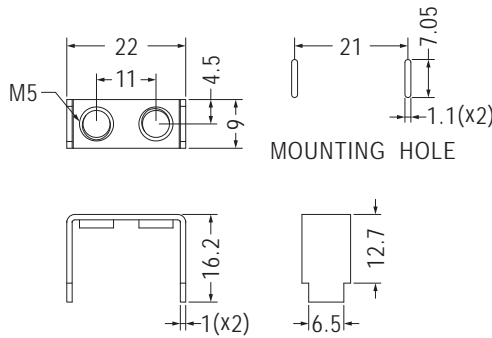

Part No.	Package
PCB-36	500

- Material: Tin Plated Brass
- Unit: mm

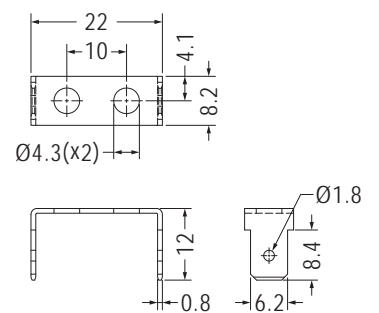

Part No.	Package
PCB-93	500

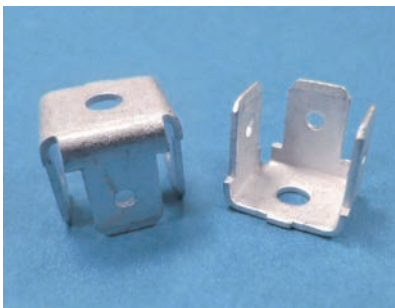

- Material: Tin Plated Brass
- Unit: mm

用途：PC板上之焊接電線端子，美觀、牢固，耐電流大，配合螺絲固定端子。

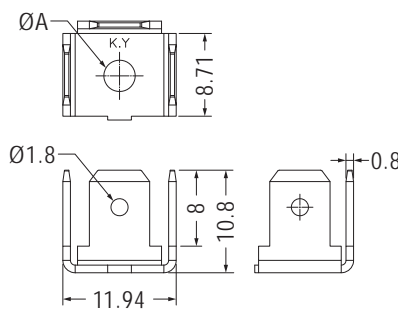

Part No.	A	Package
PC3L250-3	3.3	1000
PC3L250-4	4.3	

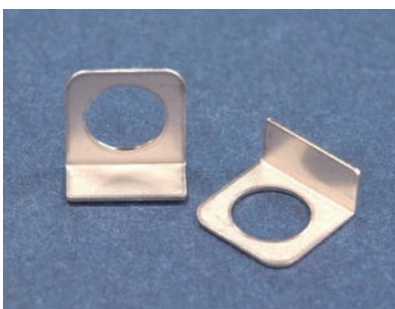

- Material: SUS
- Unit: mm

用途：PC板上之螺絲端子，美觀，牢固。

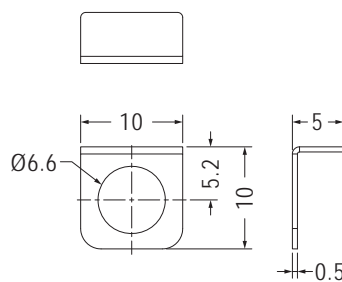

Part No.	Package
PCTL-2	1000

PC板端子 PCB TERMINAL

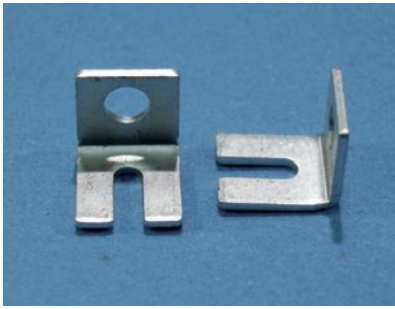

- Material: Tin Plated Brass
- Unit: mm

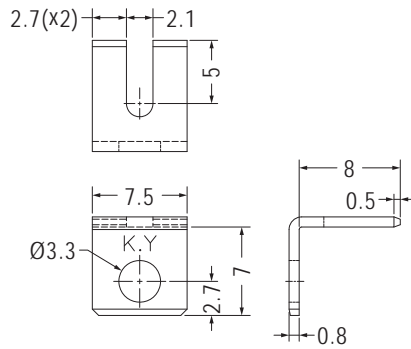

用途：PC板上之焊接電線端子，美觀、牢固，耐電流大，配合螺絲固定端子。

Part No.	Package
PCTL-3.5	1000

接地片 GROUND TERMINAL



- Material: Tin Plated Brass
- Unit: mm

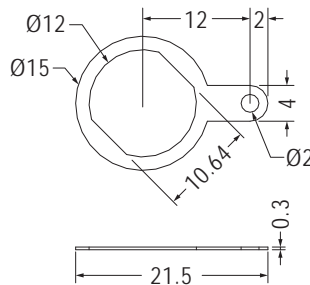

用途：用於電子、電腦儀器接地端點，一端焊於接地線，另一端用螺絲鎖於機殼。

Part No.	Package
GND-24	1000



- Material: Nickel Plated Brass
- Unit: mm

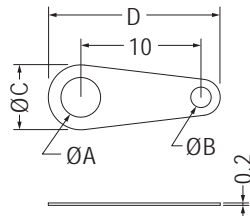

Part No.	A	B	C	D	Package
GND-1	3.2	1.6	5.5	14.3	2000
GND-3A	4.1	2.4	6.5	15.5	



- Material: Brass
- Unit: mm

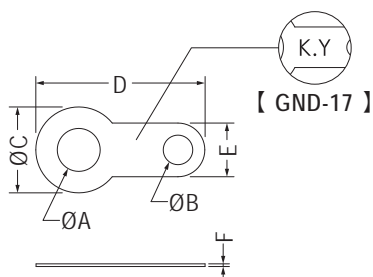

Part No.	A	B	C	D	E	F	Finish	Package
GND-2	3.2	2.1	6.4	12.6	4.0	0.25	Nickel Plated	2000
GND-3	4.3	2.0	8.0	17.7	4.6	0.3	Nickel Plated	
GND-4	5.2	2.1	9.9	19.6	5.1	0.3	Nickel Plated	1000
GND-5	8.3	1.9	10.0	15.0	4.0	0.3	Nickel Plated	
GND-6	9.7	2.0	13.0	21.5	4.0	0.4	Nickel Plated	2000
GND-10	6.3	2.1	10.0	19.9	5.1	0.3	Nickel Plated	
GND-11	9.0	2.0	13.0	30.0	4.0	0.3	Nickel Plated	1000
GND-17	4.2	1.6	6.8	12.9	3.2	0.4	Tin Plated	2000
GND-21	3.7	1.6	6.3	12.6	3.2	0.4	Tin Plated	
GND-41	3.2	1.5	4.5	12.6	3.0	0.25	Nickel Plated	2000
GND-42	2.2	1.5	4.5	12.6	3.0	0.25	Nickel Plated	

接地片 GROUND TERMINAL

用途：用於電子、電腦儀器接地端點，一端焊於接地線，另一端用螺絲鎖於機殼。

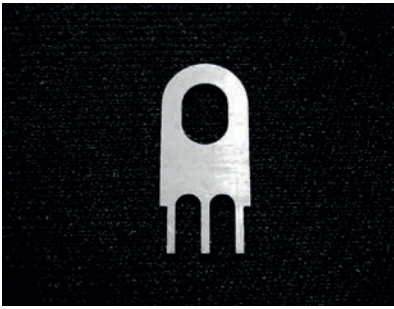

- Material: Tin Plated Brass
- Unit: mm

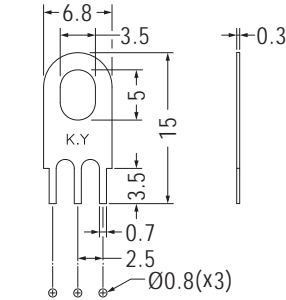

Part No.	Package
GND-34	1000

MOUNTING HOLE



- Material: Tin Plated Brass
- Unit: mm

用途：用於電子、電腦儀器接地端點，一端焊於PC板上，再用螺絲固定，接地效果佳。

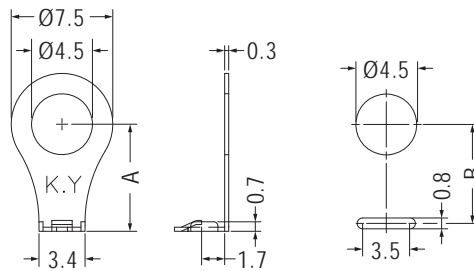

Part No.	A	B	Package
GND-32	7.9	7.6	1000
GND-51	7.6	7.3	

MOUNTING HOLE



- Material: SPCC
- Finish: Tin Plated Over Brass Base
- Unit: mm

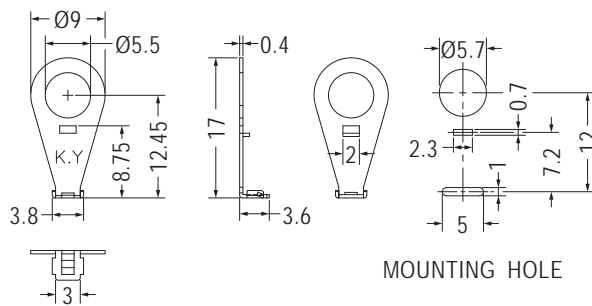

Part No.	Package
GND-96	1000

MOUNTING HOLE



- Material: Nickel Plated Phosphor Bronze
- Unit: mm

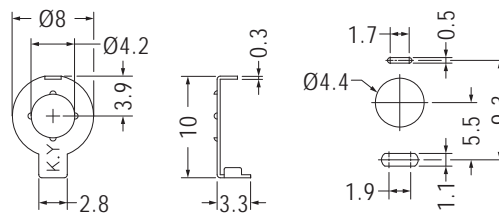

Part No.	Package
GND-7	1000

MOUNTING HOLE



- Material: Tin Plated Phosphor Bronze
- Unit: mm

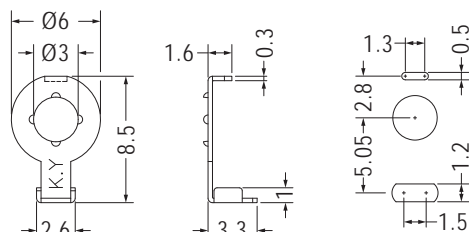

Part No.	Package
GND-103	1000

MOUNTING HOLE

接地片 GROUND TERMINAL

用途：用於電子、電腦儀器接地端點，一端焊於PC板上，再用螺絲固定，接地效果佳。



- Material: Nickel Plated Brass
- Unit: mm

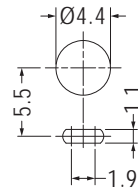
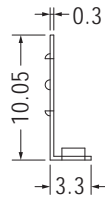
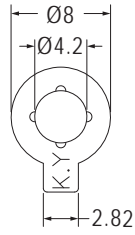

MOUNTING HOLE

Part No.	Package
GND-14	1000

- Material: Tin Plated Brass/Nickel Plated Brass
- Unit: mm

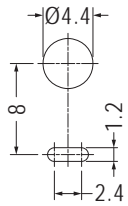
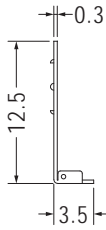
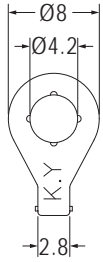

MOUNTING HOLE

Part No.	Package
GND-8	1000

- Material: Nickel Plated Phosphor Bronze
- Unit: mm

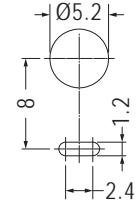
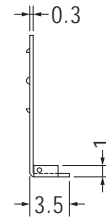
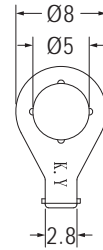

MOUNTING HOLE

Part No.	Package
GND-20	2000



- Material: Nickel Plated Brass
- Unit: mm

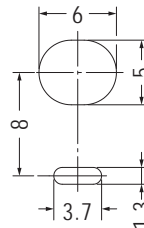
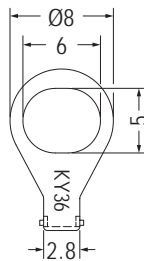

MOUNTING HOLE

Part No.	Package
GND-36	1000

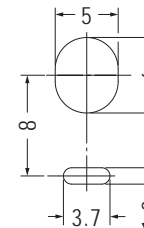
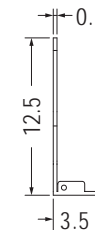
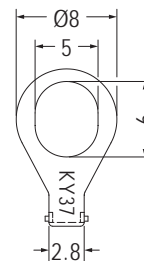

MOUNTING HOLE

Part No.	Package
GND-37	1000



- Material: Tin Plated Brass
- Unit: mm

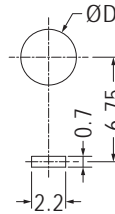
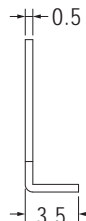
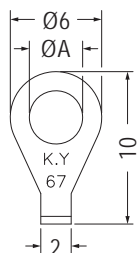

MOUNTING HOLE

Part No.	A	D	Package
GND-67	3.5	3.6	1000
GND-67(4.0)	4.0	4.1	

接地片 GROUND TERMINAL

用途：用於電子、電腦儀器接地端點，一端焊於PC板上，再用螺絲固定，接地效果佳。

- Material: Tin Plated Brass
- Unit: mm

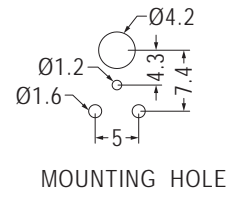
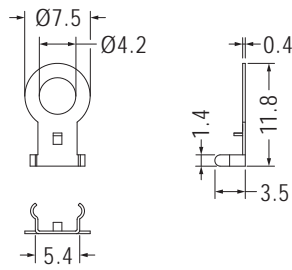

Part No.	Package
GND-13	1000

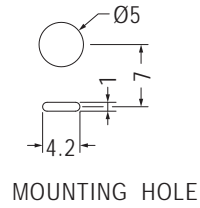
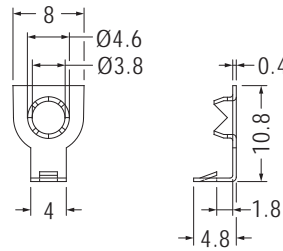

Part No.	Package
GND-12	1000

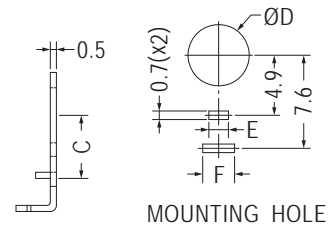
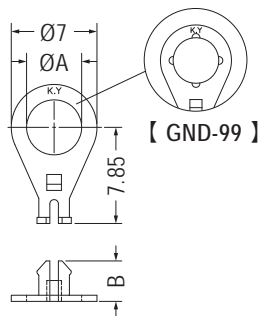

Part No.	A	B	C	D	E	F	Package
GND-15	3.5	4.6	5.1	4.0	1.5	2.7	2000
GND-35	4.5	4.6	5.1	4.5	1.5	2.7	
GND-39	4.5	3.3	5.15	5.0	1.6	2.6	1000
GND-99	4.5	3.3	5.15	5.0	1.6	2.6	

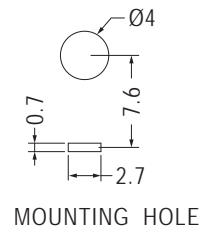
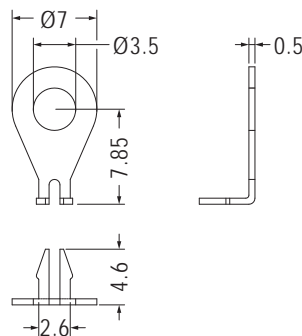

Part No.	Package
GND-23	1000

接地片 GROUND TERMINAL

用途：用於電子、電腦儀器接地端點，一端焊於PC板上，再用螺絲固定，接地效果佳。



- Material: Tin Plated SPTE
- Unit: mm

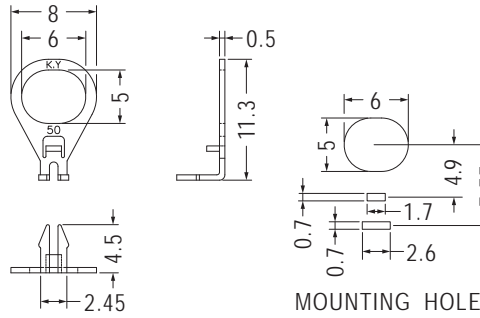

Part No.	Package
GND-50	1000

- Material: Tin Plated Brass
- Unit: mm

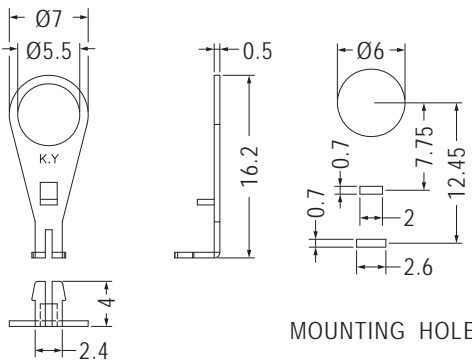

Part No.	Package
GND-55	1000



- Material: Tin Plated Phosphor Bronze
- Unit: mm

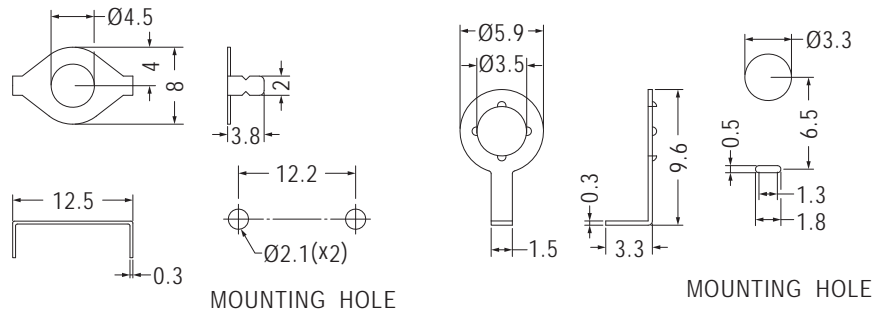

Part No.	Package
GND-44	1000

Part No.	Package
GND-49	1000

- Material: Nickel Plated Phosphor Bronze
- Unit: mm

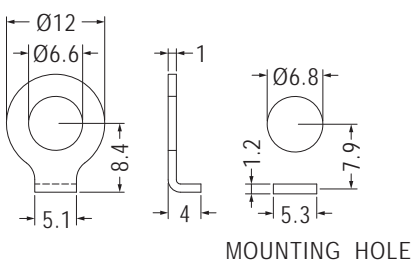

Part No.	Package
GND-52	1000

- Material: Tin Plated Brass
- Unit: mm

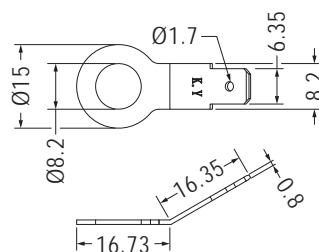

Part No.	Package
GND-54	1000

- Material: Tin Plated SPCC
- Unit: mm

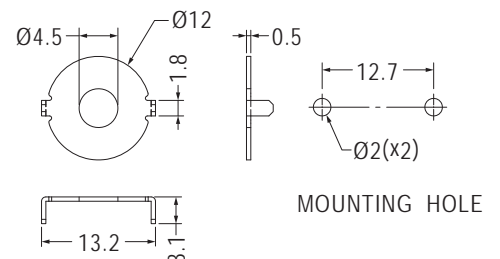

Part No.	Package
GND-56A	1000

接地片 GROUND TERMINAL



- Material: Tin Plated Phosphor Bronze
- Unit: mm

用途：用於電子、電腦儀器接地端點，一端焊於PC板上，再用螺絲固定，接地效果佳。

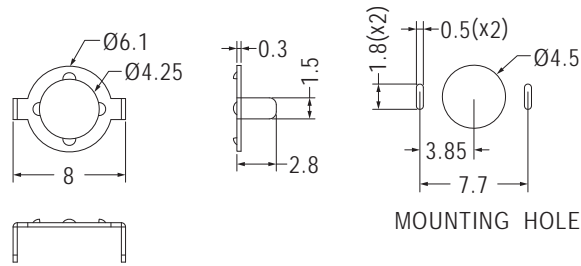

Part No.	Package
GND-74	1000



- Material: Tin Plated Brass
- Unit: mm

用途：用於電子、電腦儀器接地端點，一端焊於接地線，另一端用螺絲鎖於機殼。

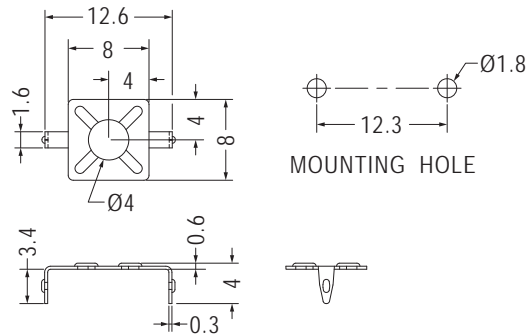

Part No.	Package
PCB-41A	1000

AAA電池彈片 POSITIVE AAA BATTERY CONTACT

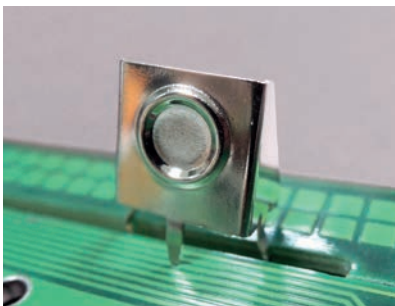

- Material: Nickel Plated Spring Steel
- Unit: mm

用途：用於4號電池的彈片。

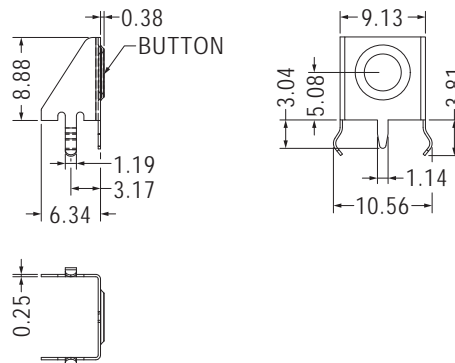

Part No.	Package
PCB-67	1000

AAA電池彈片 NEGATIVE AAA BATTERY CONTACT

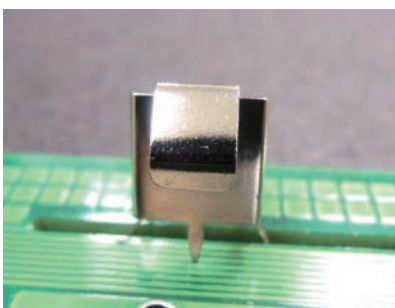

- Material: Nickel Plated Spring Steel
- Unit: mm

用途：用於4號電池的彈片。

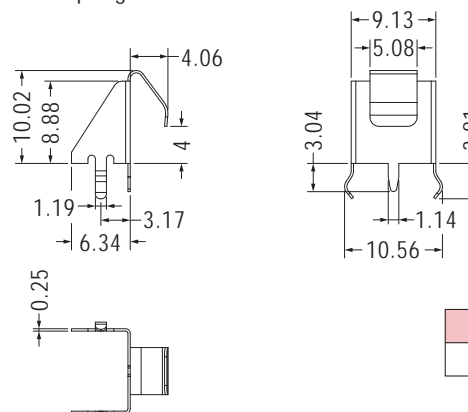

Part No.	Package
PCB-68	1000

塑膠齒輪 PLASTIC GEAR

用途：做為齒輪使用。



- Material: POM
- Color: Black
- Unit: mm

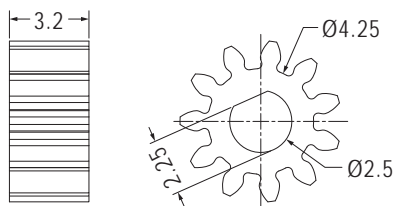

Part No.	Package
GRAP-1	1000

阻尼齒輪 DAMPER GEAR

用途：用於音響或電腦外殼使開關門平順緩慢，增加質感。



- Gear Material: POM (UL) 94HB
- Body Material: PC (UL) 94V-2
- Color: Black
- Unit: mm

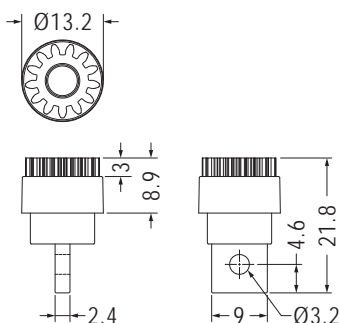

Part No.	Package
DP023A	500

Module	0.8
Pitch Circle Diameter	Ø10.4
Teeth Number	13
Pressure Angle	20°



- Gear Material: POM (UL) 94HB
- Body Material: PC (UL) 94V-2
- Color: Black
- Unit: mm

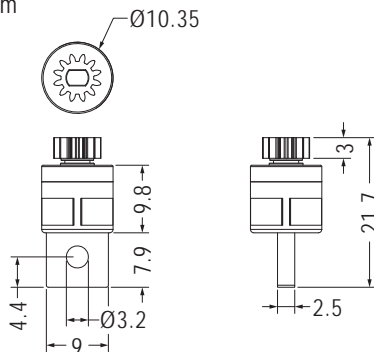

Part No.	Package
DP013A	500

Module	0.5
Pitch Circle Diameter	Ø6.0
Teeth Number	12
Pressure Angle	20°



- Gear Material: POM (UL) 94HB
- Body Material: PC (UL) 94V-2
- Gear Color: Black
- Body Color: Black/Transparent
- Unit: mm

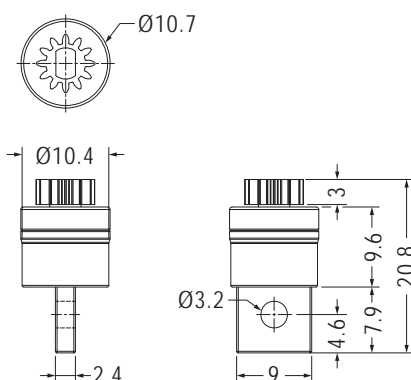

Part No.	Package
DP038A	500

Module	0.5
Pitch Circle Diameter	Ø6.0
Teeth Number	12
Pressure Angle	20°

阻尼齒輪 DAMPER GEAR

用途：用於音響或電腦外殼使開關門平順緩慢，增加質感。



- Gear Material: POM (UL) 94HB
- Body Material: ABS (UL) 94HB
- Color: Black
- Unit: mm

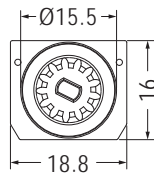

Part No.	Package
DP016A	500

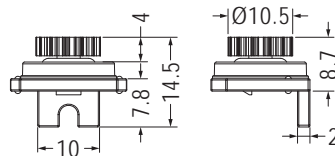
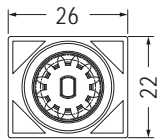

Module	0.7
Pitch Circle Diameter	Ø9.1
Teeth Number	13
Pressure Angle	20°

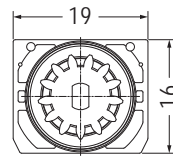
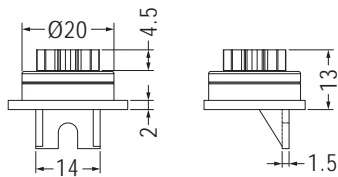

Part No.	Package
DP037A	500

Part No.	Package
DP028A	500

Module	1.0
Pitch Circle Diameter	Ø12.0
Teeth Number	12
Pressure Angle	20°

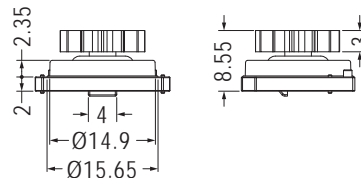

Module	0.8
Pitch Circle Diameter	Ø10.4
Teeth Number	13
Pressure Angle	20°

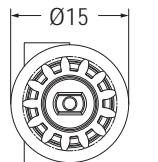

Part No.	Package
DP025A	500

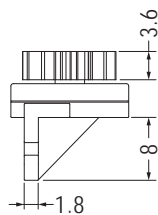

Module	0.8
Pitch Circle Diameter	Ø10.4
Teeth Number	13
Pressure Angle	14.5°

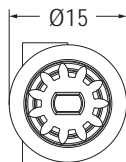
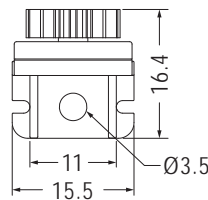

Part No.	Package
DP026A	500

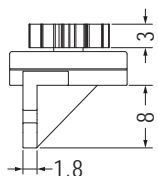

Module	0.8
Pitch Circle Diameter	Ø8.8
Teeth Number	11
Pressure Angle	20°

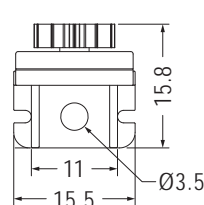

阻尼齒輪 DAMPER GEAR

用途：用於音響或電腦外殼使開關門平順緩慢，增加質感。



- Gear Material: POM (UL) 94HB
- Body Material: ABS (UL) 94HB
- Color: Black
- Unit: mm

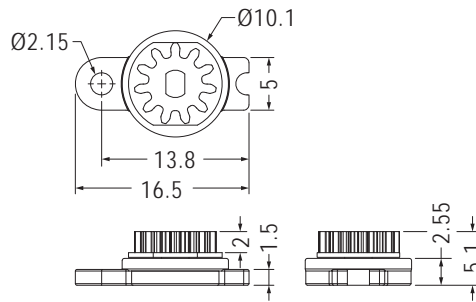

Part No.	Package
DP006A	500

Module	0.6
Pitch Circle Diameter	Ø6.6
Teeth Number	11
Pressure Angle	20°

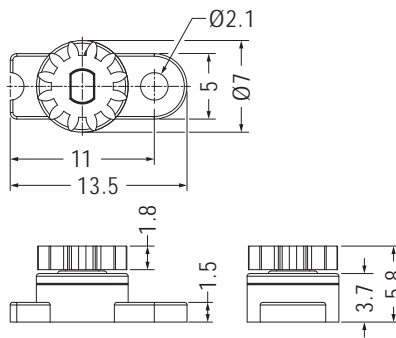

Part No.	Package
DP032A	500

Module	0.5
Pitch Circle Diameter	Ø6.0
Teeth Number	12
Pressure Angle	20°

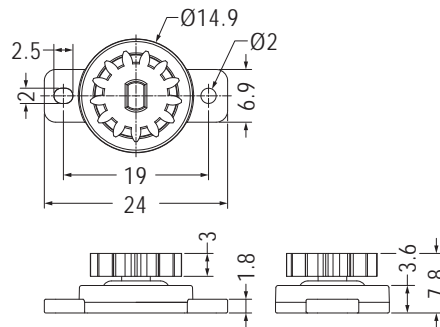

Part No.	Package
DP008A	500

Module	0.8
Pitch Circle Diameter	Ø10.4
Teeth Number	13
Pressure Angle	20°

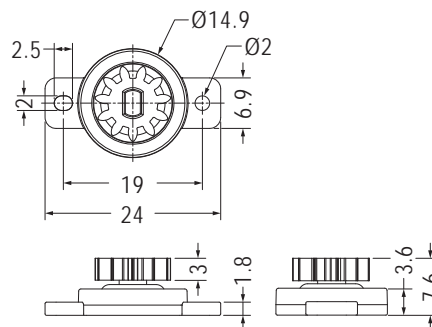

Part No.	Package
DP018A	500

Module	0.8
Pitch Circle Diameter	Ø8.8
Teeth Number	11
Pressure Angle	20°

阻尼齒輪 DAMPER GEAR

用途：用於音響或電腦外殼使開關門平順緩慢，增加質感。



- Gear Material: POM (UL) 94HB
- Body Material: ABS (UL) 94HB
- Color: Black
- Unit: mm

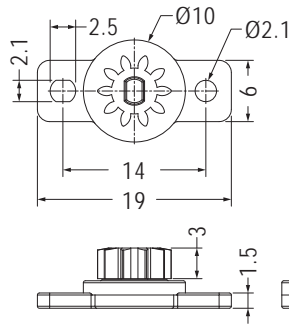

Part No.	Package
DP030A	500

Module	0.6
Pitch Circle Diameter	Ø6.0
Teeth Number	10
Pressure Angle	20°

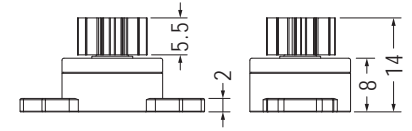
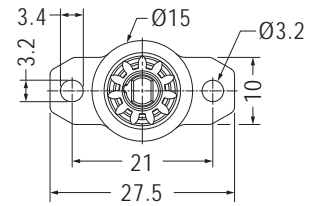

Part No.	Package
DP034A	500

Module	0.8
Pitch Circle Diameter	Ø8.8
Teeth Number	11
Pressure Angle	20°

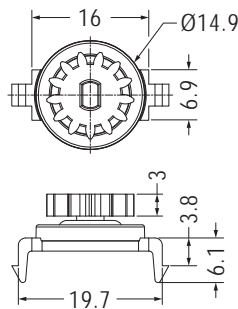

Part No.	Package
DP007A	500

Module	0.8
Pitch Circle Diameter	Ø10.4
Teeth Number	13
Pressure Angle	20°

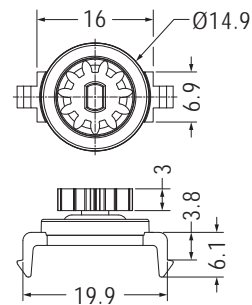

Part No.	Package
DP017A	500

Module	0.8
Pitch Circle Diameter	Ø8.8
Teeth Number	11
Pressure Angle	20°

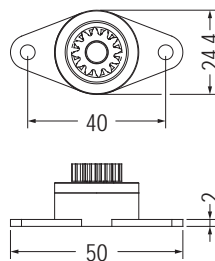

Part No.	Package
DP010A	500

Module	1.0
Pitch Circle Diameter	Ø12.0
Teeth Number	12
Pressure Angle	20°

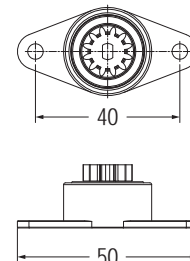

Part No.	Package
DP036A	500

Module	1.0
Pitch Circle Diameter	Ø12.0
Teeth Number	12
Pressure Angle	20°

連接器 MINI JUMPER

用途：讓連接器兩個端點導通。



- Housing Material: PBT(UL)
- Flame Class: 94V-0
- Terminal Material: Brass
- Finish: Gold Plated
- Unit: mm

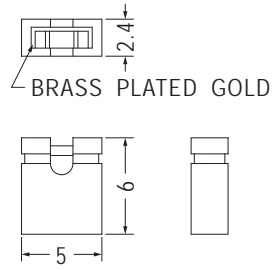

Part No.	Color	Package
MINI-1	Black	2000
MINI-1(R)	Red	
MINI-1(Y)	Yellow	
MINI-1(G)	Green	
MINI-1(BU)	Blue	



- Material: Nylon 66(UL)
- Flame Class: 94V-0
- Terminal Material: Brass
- Color: Black
- Unit: mm

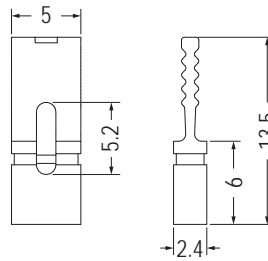

Part No.	Package
MINI-2	1000