

排線固定板 FLAT CABLE CLAMP

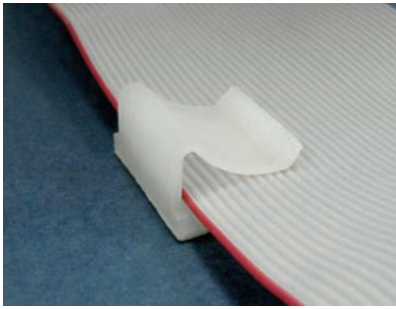

- Material: Nylon 66 (UL)
- Flame Class: 94V-2/94V-0
- Color: Natural/Black
- Unit: mm

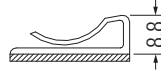
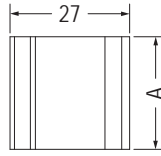

3M DOUBLE ADHESIVE TAPE

Part No.	A	Package
FCN-15	15.0	500
FCN-20	20.0	
FCN-25	25.4	

用途：背膠式，用於電子、電腦內部排線固定，裝配容易，美觀不脫落。

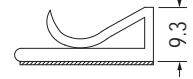
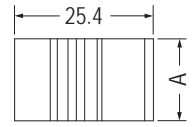

3M DOUBLE ADHESIVE TAPE

- Material: PVC
- Color: Gray

Part No.	A	Package
FCC-15	15.0	500
FCC-20	20.0	
FCC-25	25.0	250

4

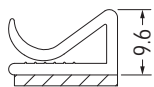
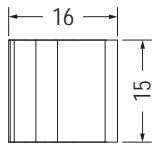

3M DOUBLE ADHESIVE TAPE

Part No.	Package
FCN-16	500

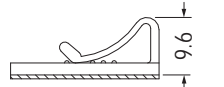
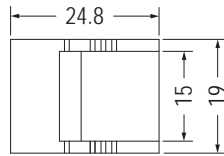

3M DOUBLE ADHESIVE TAPE

Part No.	Package
FC-19	500

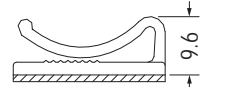
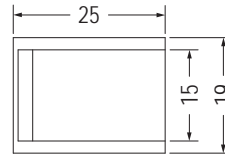

3M DOUBLE ADHESIVE TAPE

Part No.	Package
FC-19L	500

RELEASE TAB
易撕型背膠

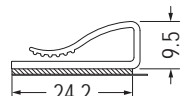
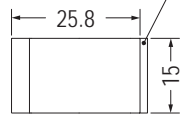

3M DOUBLE ADHESIVE TAPE

Part No.	Package
FCF-15	500

電線固定座 CABLE CLAMP

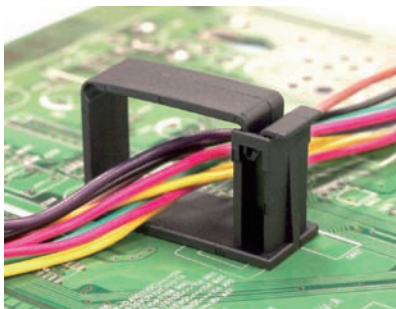

- Material: Nylon 66 (UL)
- Flame Class: 94V-2/94V-0
- Color: Natural/Black
- Unit: mm

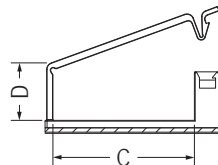
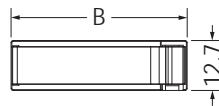

3M DOUBLE ADHESIVE TAPE

Part No.	B	C	D	Package
FCA-20	44.8	36.0	14.6	200
FCA-21	61.0	52.2	10.7	

用途：背膠式，用於電子、電腦內部電線固定，裝配容易，美觀不脫落。

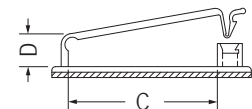
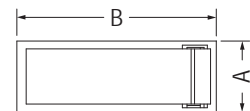

3M DOUBLE ADHESIVE TAPE

Part No.	A	B	C	D	Package
FCA-1	19.7	77.6	64.0	9.95	50
FCA-2	19.0	53.5	40.0	8.9	100
FCA-3	19.0	45.8	32.0	8.44	200
FCA-24	16.0	50.0	37.6	15.2	

電線固定座 CABLE CLAMP

用途：背膠式，用於電子、電腦內部電線固定，裝配容易，美觀不脫落。

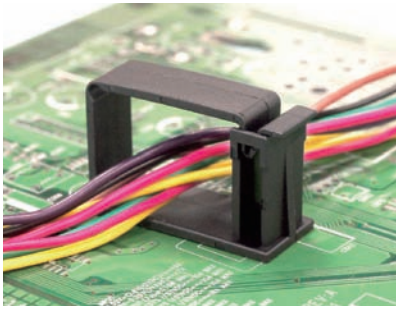

- Material: Nylon 66 (UL)
- Flame Class: 94V-2/94V-0
- Color: Natural/Black
- Unit: mm

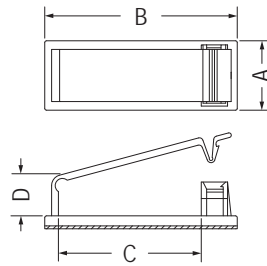

3M DOUBLE ADHESIVE TAPE

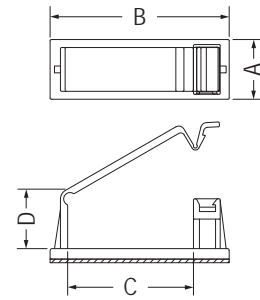

3M DOUBLE ADHESIVE TAPE

Part No.	A	B	C	D	Package
FCA-5	19.8	45.4	31.8	15.2	200
FCA-6	19.3	53.5	39.7	12.0	
FCA-7	19.3	53.5	39.7	11.7	
FCA-8	19.2	53.5	39.7	9.5	
FCA-19	18.7	55.2	41.3	7.0	

Part No.	A	B	C	D	Package
FCA-9	15.0	45.0	31.6	14.95	200
FCA-10	19.0	78.2	64.6	14.8	100
FCA-11	15.0	38.5	27.0	11.6	200
FCA-14	19.8	66.5	52.6	12.1	
FCA-17	14.8	38.0	26.9	24.1	
FCA-18	14.8	38.0	26.9	30.1	

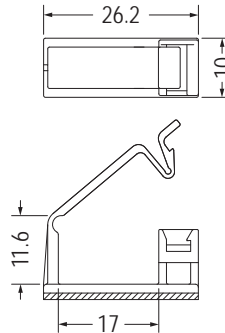
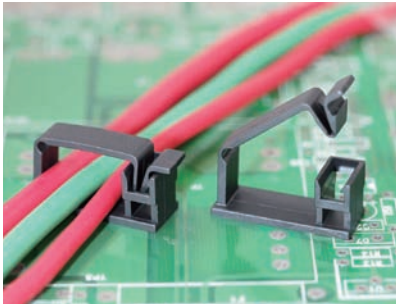

3M DOUBLE ADHESIVE TAPE

Part No.	Package
FCA-25	200

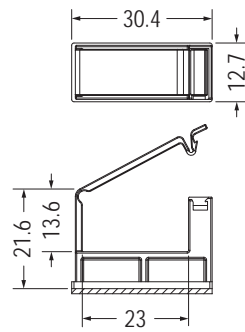

3M DOUBLE ADHESIVE TAPE

Part No.	Package
FCAC-1	1000

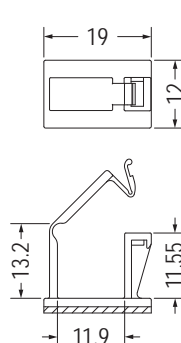
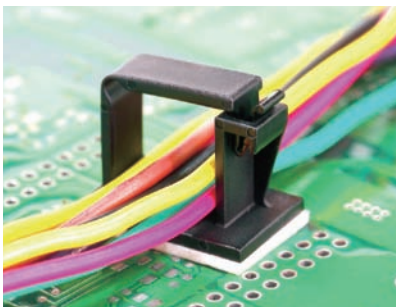

3M DOUBLE ADHESIVE TAPE

Part No.	Package
FCAB-1	500

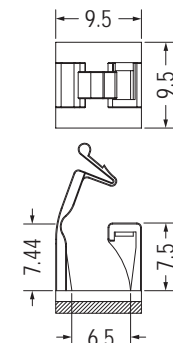

3M DOUBLE ADHESIVE TAPE

Part No.	Package
FCAB-7	1000

電線固定座 CABLE CLAMP

用途：背膠式，用於電子、電腦內部電線固定，裝配容易，美觀不脫落。

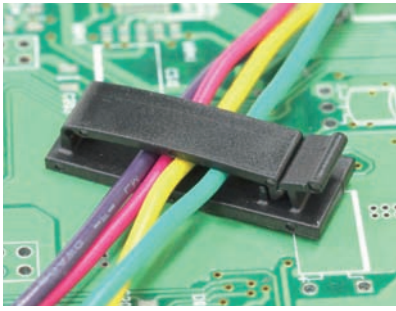

- Material: Nylon 66 (UL)
- Flame Class: 94V-2/94V-0
- Color: Natural/Black
- Unit: mm

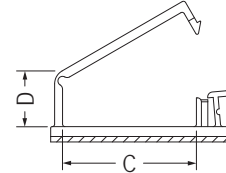
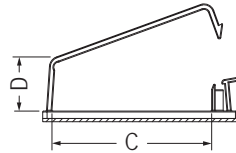
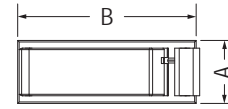
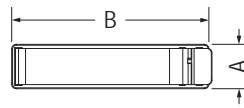

3M DOUBLE ADHESIVE TAPE

3M DOUBLE ADHESIVE TAPE

【 FCU-14 】

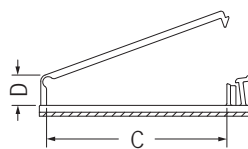
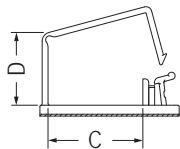
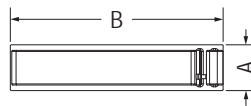
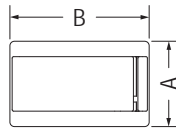

3M DOUBLE ADHESIVE TAPE

3M DOUBLE ADHESIVE TAPE

【 FCU-9 】

【 FCU-13 】

Part No.	A	B	C	D	Package
FCU-1	12.7	40.7	31.5	5.5	200
FCU-2	12.7	36.0	27.0	11.2	
FCU-3	15.0	36.0	27.0	13.9	
FCU-4	12.5	35.8	26.8	8.3	
FCU-5	12.7	26.2	17.0	4.55	
FCU-7	10.0	28.0	19.0	3.4	100
FCU-8	12.9	72.3	63.1	6.7	
FCU-9	18.8	30.7	20.9	16.0	
FCU-12	10.0	26.2	17.0	11.6	
FCU-13	12.7	59.0	50.0	8.4	
FCU-14	15.0	66.7	54.0	20.0	200
FCU-15	12.7	41.0	32.0	12.4	

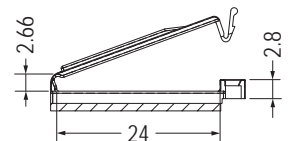
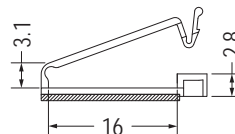
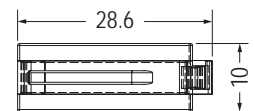
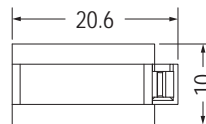

3M DOUBLE ADHESIVE TAPE

3M DOUBLE ADHESIVE TAPE

Part No.	Package
FCAB-2	500

Part No.	Package
FCAB-3	500

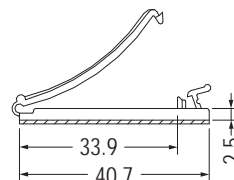
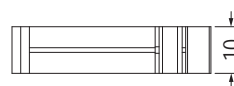
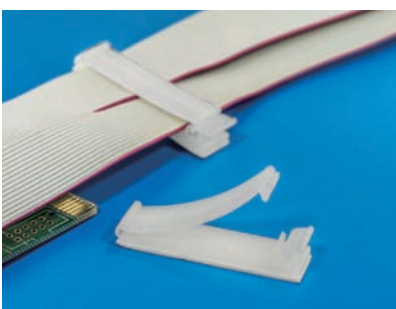

3M DOUBLE ADHESIVE TAPE

Part No.	Package
FCJ-40	100

電線固定座 CABLE CLAMP

用途：背膠式，用於電子、電腦內部電線固定，裝配容易，美觀不脫落。

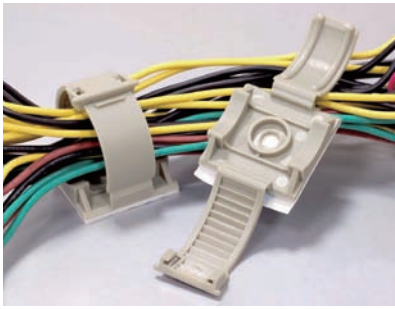

- Material: Nylon 66 (UL)
- Flame Class: 94V-2/94V-0
- Color: Natural/Black/Gray
- Unit: mm

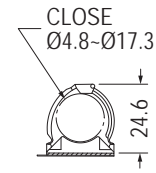
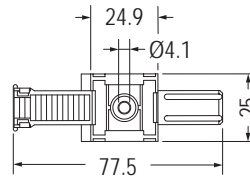

3M DOUBLE ADHESIVE TAPE

Part No.	Package
CWK-1	200



- Material: Nylon 66 (UL)
- Flame Class: 94V-2/94V-0
- Color: Natural/Black/Gray
- Unit: mm

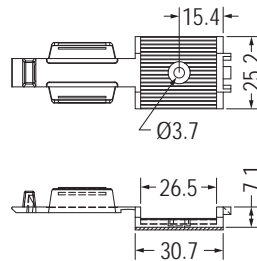

3M DOUBLE ADHESIVE TAPE

Part No.	Package
FCH-29	100

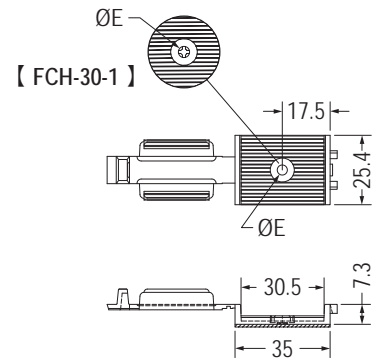

3M DOUBLE ADHESIVE TAPE

Part No.	E	Package
FCH-30	3.7	100
FCH-30-1	4.5	

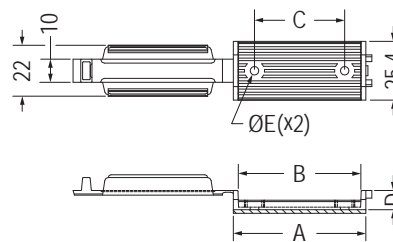
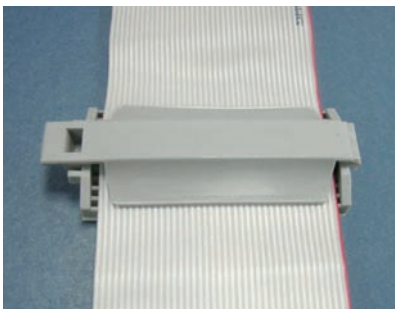

3M DOUBLE ADHESIVE TAPE

Part No.	A	B	C	D	E	Package
FCH-50	57.3	53.0	39.0	8.3	3.7	50
FCH-80	82.3	78.93	38.7	12.3	3.8	

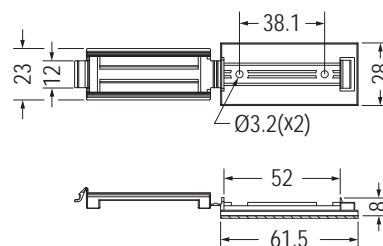

3M DOUBLE ADHESIVE TAPE

Part No.	Package
FCHA-1	50

電線固定座 CABLE CLAMP

用途：背膠式，用於電子、電腦內部電線固定，裝配容易，美觀不脫落。

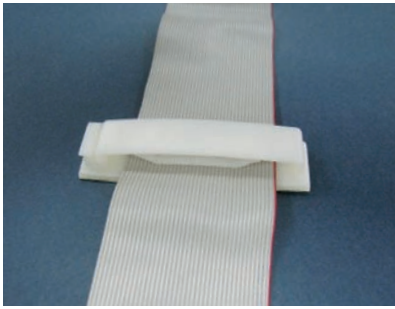

- Material: Nylon 66 (UL)
- Flame Class: 94V-2/94V-0
- Color: Natural/Black
- Unit: mm

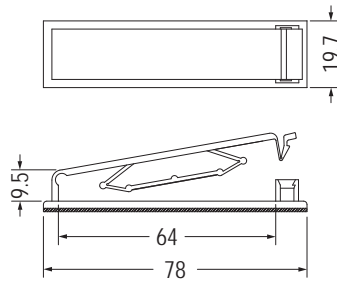

3M DOUBLE ADHESIVE TAPE
SUITABLE CABLE 50 PIN

Part No.	Package
FCB-1	100

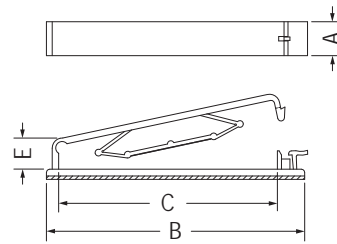

3M DOUBLE ADHESIVE TAPE
SUITABLE CABLE: P

Part No.	A	B	C	E	P	Package
FCB-40	10.2	65.0	53.8	8.23	40 PIN	200
FCB-50	10.0	77.0	64.5	9.2	50 PIN	100

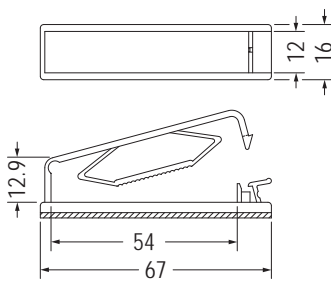

3M DOUBLE ADHESIVE TAPE
SUITABLE CABLE 40 PIN



【FCB-40M】
沒有擋板
No Stopper

Part No.	Package
FCB-40M	100
FCB-40MT	

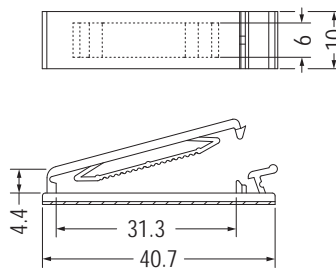

3M DOUBLE ADHESIVE TAPE

Part No.	Package
FCI-1	200

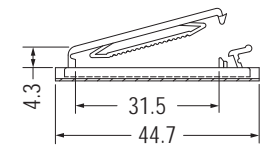
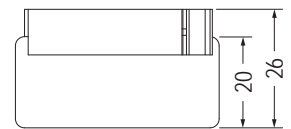

3M DOUBLE ADHESIVE TAPE

Part No.	Package
FCI-2	100

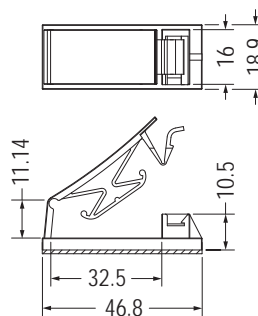

3M DOUBLE ADHESIVE TAPE

Part No.	Package
FCAM-1	100

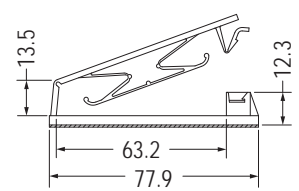
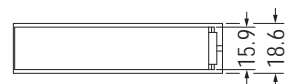

3M DOUBLE ADHESIVE TAPE

Part No.	Package
FCK-50	100

電線固定座 CABLE CLAMP

用途：背膠式，用於電子、電腦內部電線固定，裝配容易，美觀不脫落。

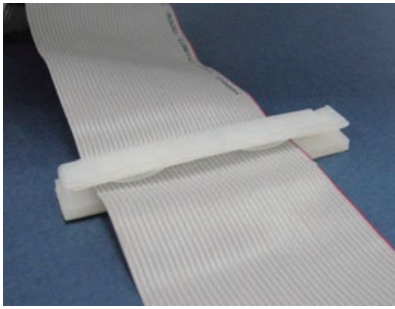

- Material: Nylon 66 (UL)
- Flame Class: 94V-2/94V-0
- Color: Natural/Black
- Unit: mm

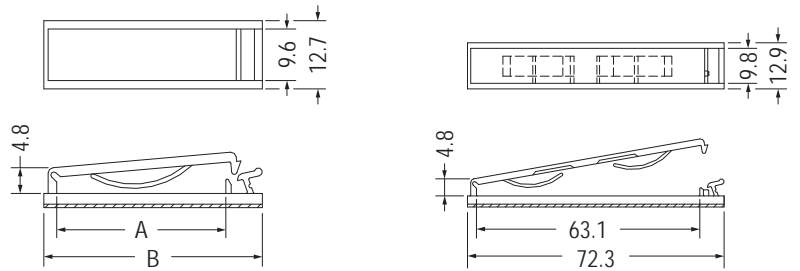

3M DOUBLE ADHESIVE TAPE

3M DOUBLE ADHESIVE TAPE

Part No.	A	B	Package
FCE-1	31.5	40.7	200
FCE-2	52.0	61.2	100

Part No.	Package
FCE-3	100

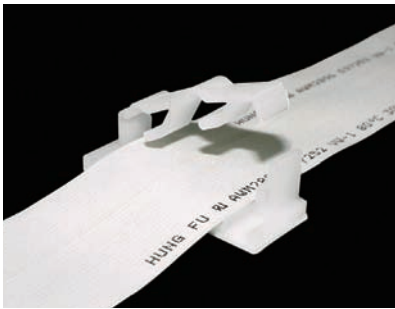

- Material: Nylon 66 (UL)
- Flame Class: 94V-2/94V-0
- Color: Natural/Black
- Unit: mm

用途：可背膠或螺絲固定，用於電子、電腦內部電線固定，裝配容易，美觀不脫落。

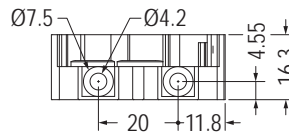

3M DOUBLE ADHESIVE TAPE

Part No.	Package
FCL-33	200

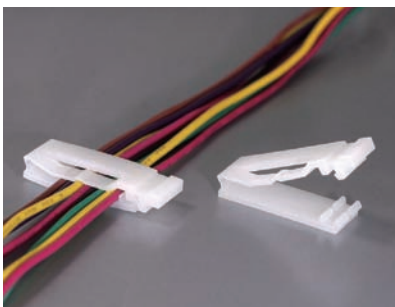

- Material: Nylon 66 (UL)
- Flame Class: 94V-2/94V-0
- Color: Natural/Black
- Unit: mm

用途：背膠式，用於電子、電腦內部電線固定，裝配容易，美觀不脫落。

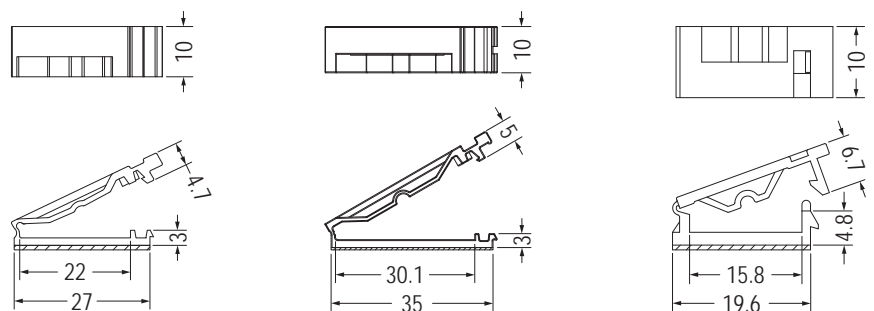

3M DOUBLE ADHESIVE TAPE

3M DOUBLE ADHESIVE TAPE

3M DOUBLE ADHESIVE TAPE

Part No.	Package
FCS-2	200

Part No.	Package
FCS-20	200

Part No.	Package
FCS-15	500

電線固定座 CABLE CLAMP

用途：背膠式，用於電子、電腦內部電線固定，裝配容易，美觀不脫落。

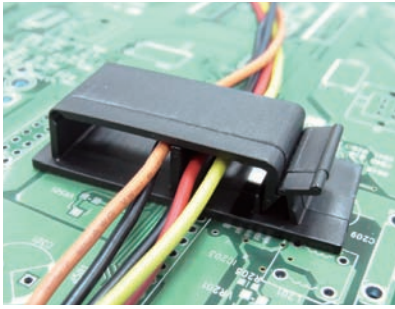

- Material: Nylon 66 (UL)
- Flame Class: 94V-2/94V-0
- Color: Natural/Black
- Unit: mm

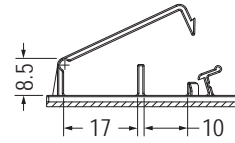
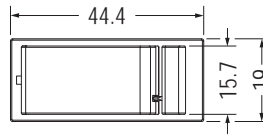

3M DOUBLE ADHESIVE TAPE

Part No.	Package
FCUB-1	200

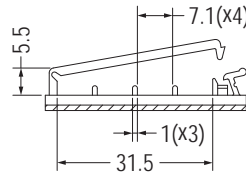
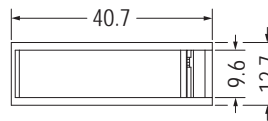

3M DOUBLE ADHESIVE TAPE

Part No.	Package
FCUB-2	200

排線固定夾 FLAT CABLE CLAMP

用途：用於電子、電腦內部排線固定，裝配容易，美觀不脫落。



- Material: Nylon 66 (UL)
- Flame Class: 94V-2/94V-0
- Color: Natural/Black
- Unit: mm

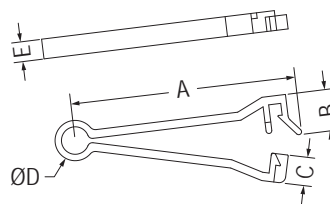

SUITABLE CABLE: P

Part No.	A	B	C	D	E	P	Package
FCE-30	62.3	13.0	8.9	12.0	6.4	30 PIN	100
FCE-40	70.2	12.2	8.7	12.8	6.2	40 PIN	

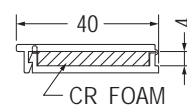
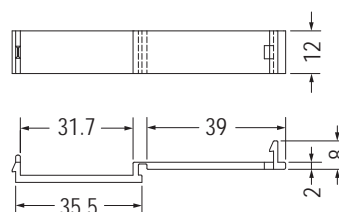

Part No.	Package
FCS-31	100

電線固定座 CABLE CLAMP

用途：配合螺絲，固定電線，美觀不脫落。



- Material: Nylon 66 (UL)
- Flame Class: 94V-2/94V-0
- Color: Natural/Black
- Unit: mm

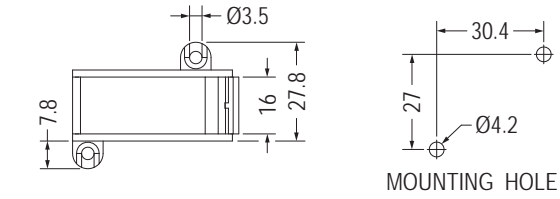

Part No.	Package
FCUA-1	200

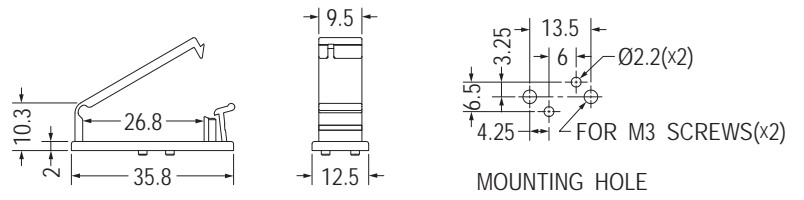
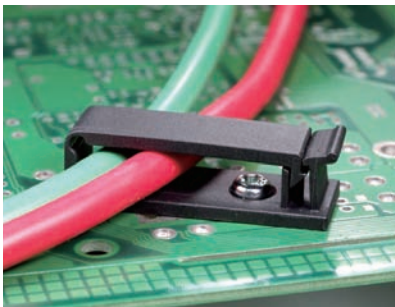
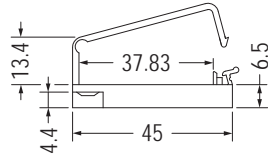

Part No.	Package
FCUA-7	200

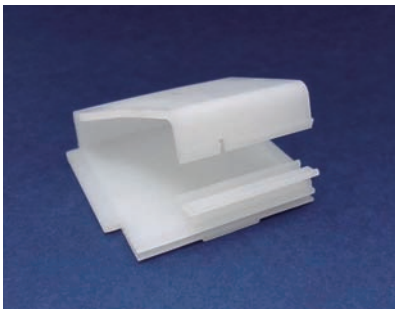
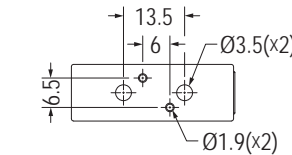

- Material: Nylon 66 (UL)
- Flame Class: 94V-2/94V-0
- Color: Natural/Black
- Unit: mm

用途：用於電線之固定。

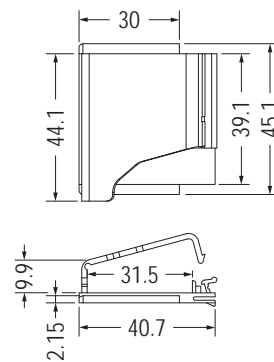

Part No.	Package
FCUA-2	200

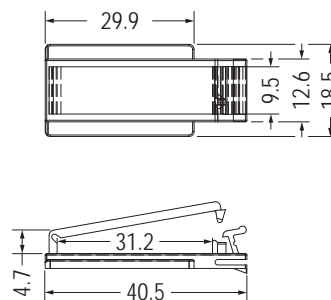

Part No.	Package
FCUA-4	200

電線固定座 CABLE CLAMP

用途：用於電子、電腦內部電線固定，
裝配容易，美觀不脫落。

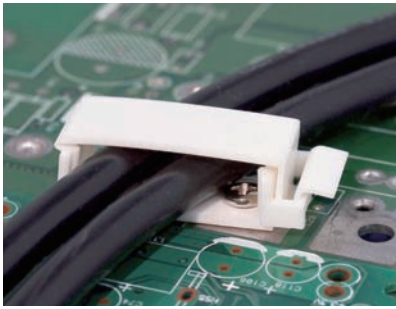

- Material: Nylon 66 (UL)
- Flame Class: 94V-2/94V-0
- Color: Natural/Black
- Unit: mm

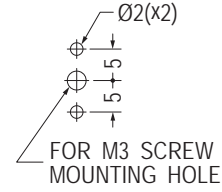
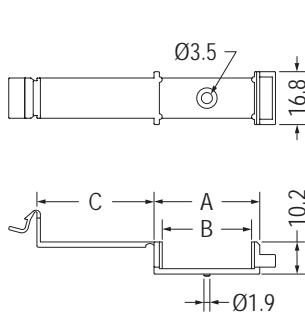

Part No.	A	B	C	Package
FCSA-2	33.6	28.4	37.2	100
FCSA-3	47.8	42.6	51.4	

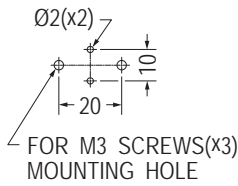
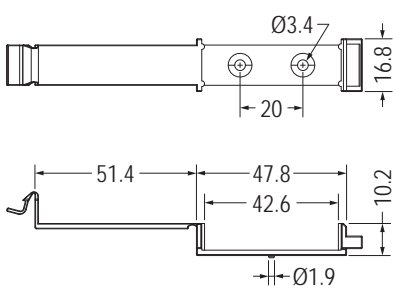

NEW

Part No.	Package
FCSA-17	100

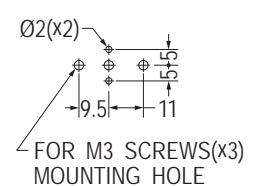
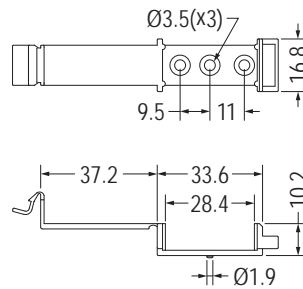

Part No.	Package
FCSA-6	100

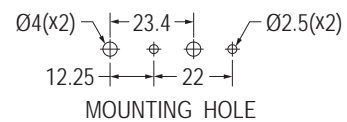
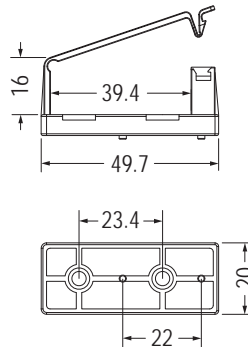

Part No.	Package
FCSA-7	100

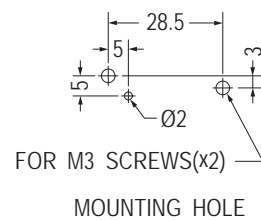
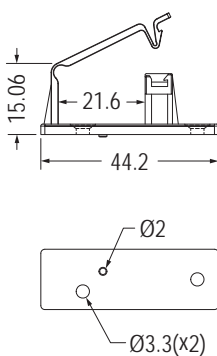
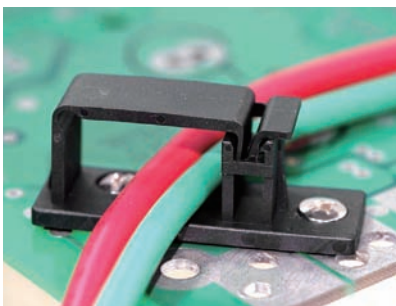

Part No.	Package
FCSA-10	250

電線固定座 CABLE CLAMP

用途：背膠式，用於電子、電腦內部電線固定，裝配容易，美觀不脫落。

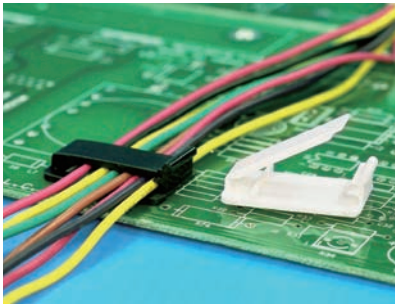

- Material: Nylon 66 (UL)
- Flame Class: 94V-2/94V-0
- Color: Natural/Black
- Unit: mm

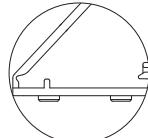

【 MIBB-7 】

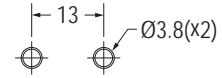
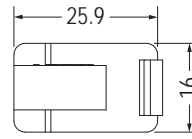

MOUNTING HOLE

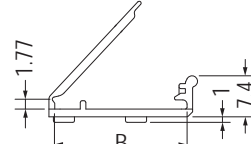

DOUBLE ADHESIVE TAPE

Part No.	B	Package
MIBB-6	23.9	1000
MIBB-7	23.85	

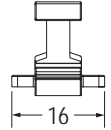
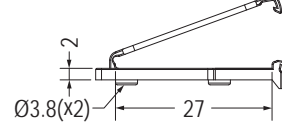
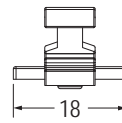
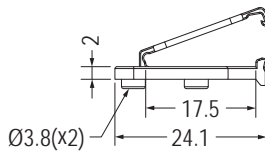
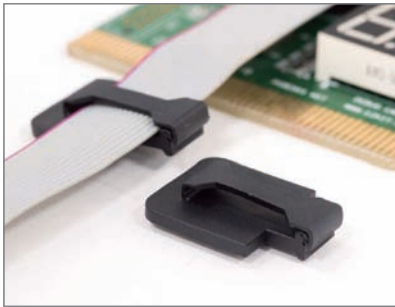

3M DOUBLE ADHESIVE TAPE
RELEASE TAB 易撕型背膠

Part No.	Package
MIBD-3	1000

3M DOUBLE ADHESIVE TAPE
RELEASE TAB 易撕型背膠

Part No.	Package
MIBB-9	1000



- Material: Nylon 66 (UL)
- Flame Class: 94V-2/94V-0
- Color: Natural/Black
- Unit: mm

用途：用於電子、電腦內部電線固定，裝配容易，美觀不脫落。

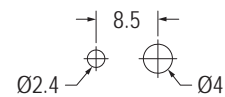
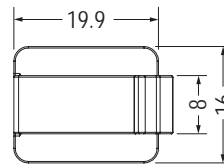

MOUNTING HOLE
THICKNESS 0.6-0.8

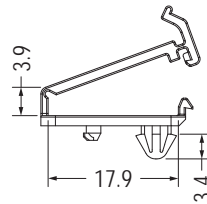

Part No.	Package
MIB-32	1000

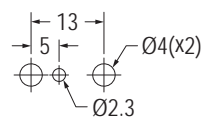
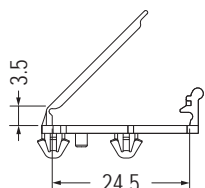
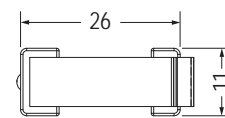
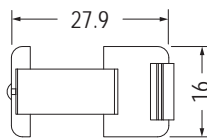
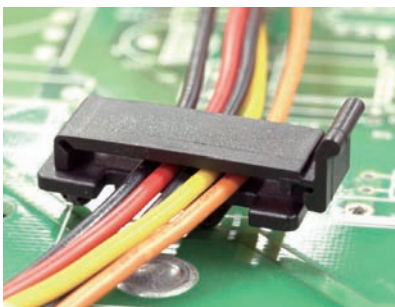

MOUNTING HOLE
THICKNESS 0.5-0.8

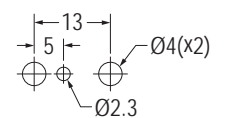
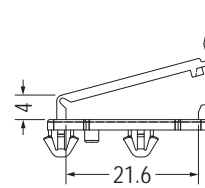

MOUNTING HOLE
THICKNESS 0.5-0.8

Part No.	Package
MIBB-1	1000

Part No.	Package
MIBB-2	1000

電線固定座 CABLE CLAMP

用途：用於電子、電腦內部電線固定，
裝配容易，美觀不脫落。

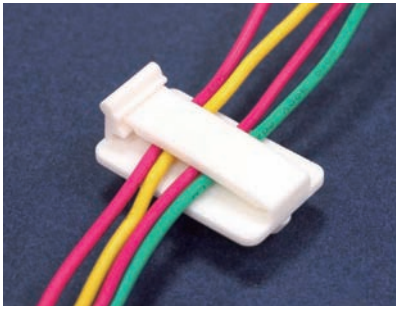

- Material: Nylon 66 (UL)
- Flame Class: 94V-2/94V-0
- Color: Natural/Black
- Unit: mm

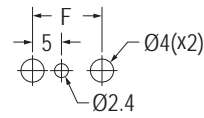
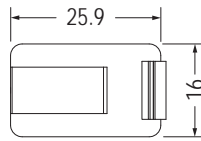

MOUNTING HOLE
THICKNESS 1.0

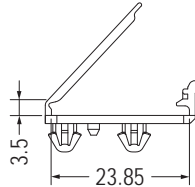

Part No.	F	Package
MIBB-3	12.0	1000
MIBB-5	13.0	

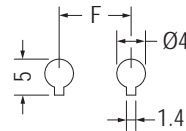
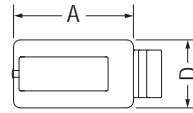
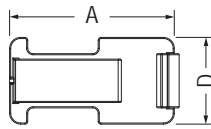

MOUNTING HOLE
THICKNESS 0.5-0.8

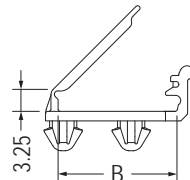
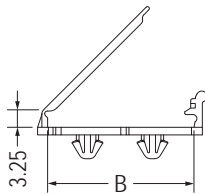

【 MIBB-13 】

Part No.	A	B	D	F	Package
MIBB-11	17.65	17.5	10.0	10.0	1000
MIBB-12	21.15	21.0	10.0	12.0	
MIBB-13	30.4	27.0	16.0	12.0	

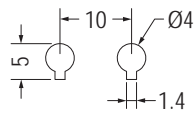
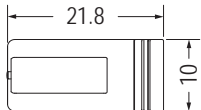

MOUNTING HOLE
THICKNESS 1.5

Part No.	Package
MIBB-16	1000

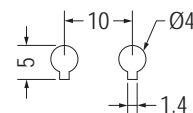
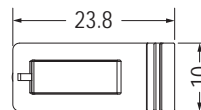

MOUNTING HOLE
THICKNESS: T

Part No.	T	Package
MIBB-19	1.5	1000
MIBB-19S	1.0-1.2	

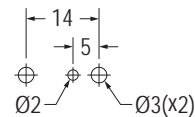
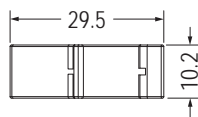
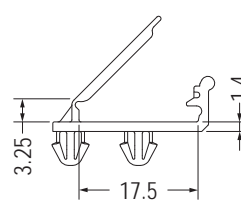
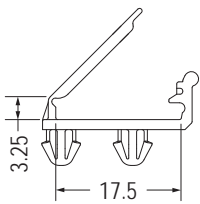

MOUNTING HOLE
THICKNESS 1.0

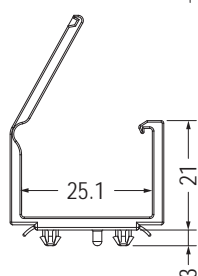

Part No.	Package
MIBA-4	500

電線固定座 CABLE CLAMP

用途：用於電子、電腦內部電線固定，
裝配容易，無背膠，美觀不脫落。

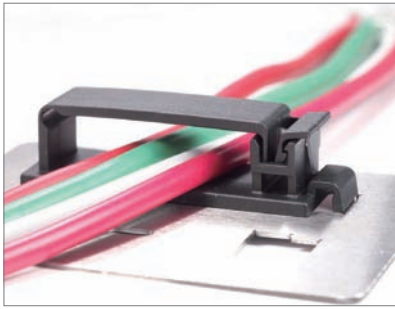

- Material: Nylon 66 (UL)
- Flame Class: 94V-2/94V-0
- Color: Natural/Black
- Unit: mm



使用說明
Installation Guide

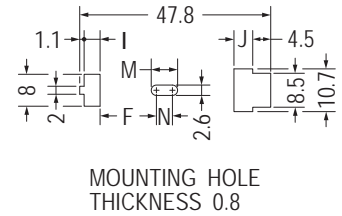
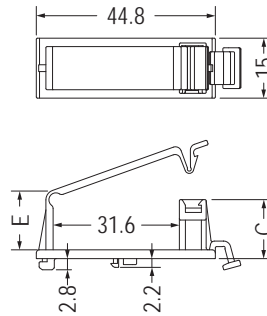

Part No.	C	E	F	I	J	M	N	Package
CHWC-1	14.75	15.0	14.1	4.0	4.7	6.6	4.0	500
★CHWC-11	10.42	10.52	13.2	4.9	5.5	9.0	6.4	200

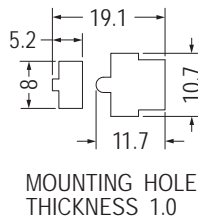
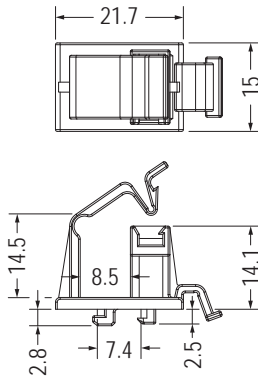

Part No.	Package
CHWC-2	500

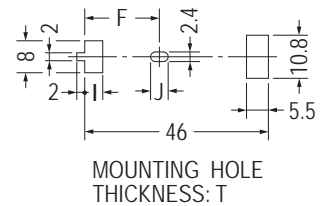
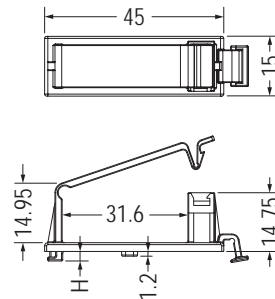

Part No.	F	H	I	J	T	Package
CHWC-3	18.7	2.4	4.5	4.4	1.2	100
CHWC-9	19.6	2.0	4.6	6.4	0.8	200

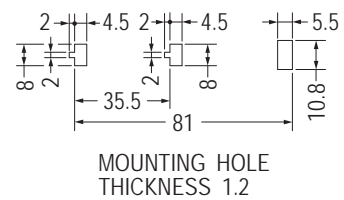
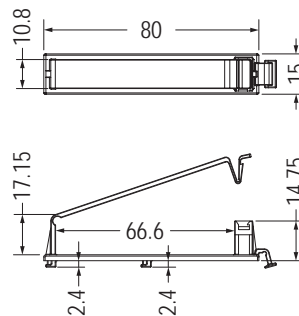
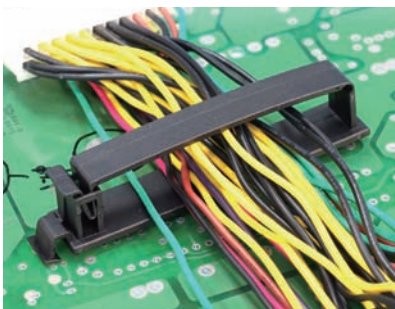

Part No.	Package
CHWC-6	500

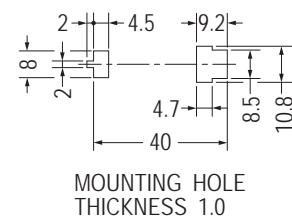
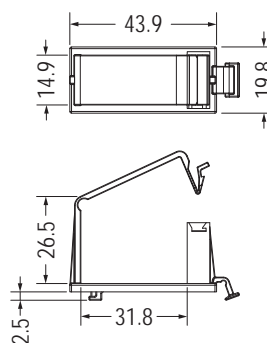

Part No.	Package
CHWC-10	100

電線固定座 CABLE CLAMP

用途：用於電子、電腦內部電線固定，裝配容易，美觀不脫落。

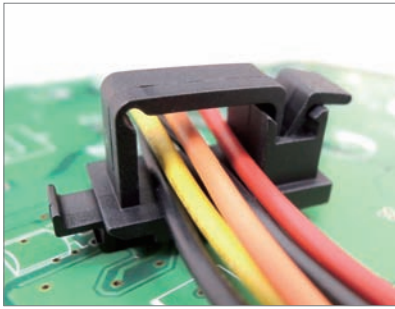

- Material: Nylon 66 (UL)
- Flame Class: 94V-2/94V-0
- Color: Natural/Black
- Unit: mm

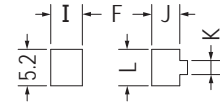
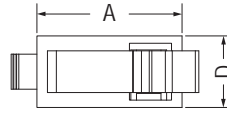

MOUNTING HOLE THICKNESS 0.8

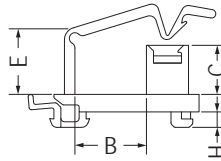

Part No.	A	B	C	D	E	F	H	I	J	K	L	Package
CHWB-1	20.7	10.3	7.0	10.2	9.51	9.9	2.2	4.5	4.0	2.0	5.2	500
CHWB-2	35.28	25.25	11.0	15.2	13.17	26.0	2.1	4.0	3.0	1.5	5.5	

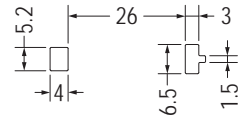
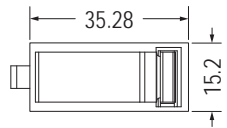
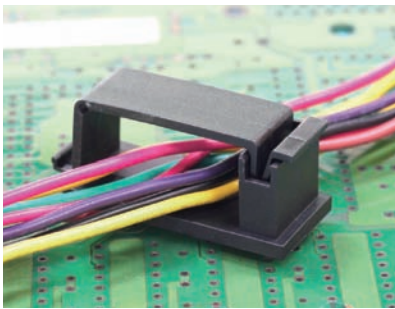

MOUNTING HOLE THICKNESS 0.8

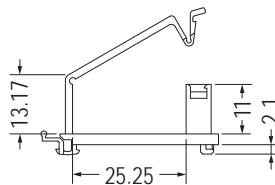

Part No.	Package
CHWB-4	500

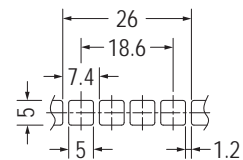
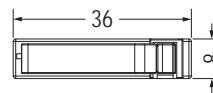

MOUNTING HOLE THICKNESS 0.8

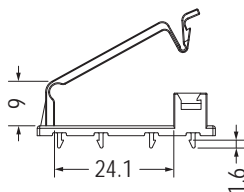

Part No.	Package
FCTI-1	500

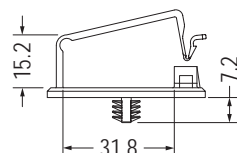
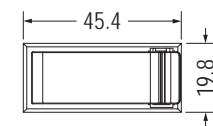

MOUNTING HOLE $\varnothing 6.5\text{-}\varnothing 7.0$
THICKNESS 0.8-3.0

Part No.	Package
FCUT-1	500

電線固定座 CABLE CLAMP

用途：用於電子、電腦內部電線固定，
裝配容易，美觀不脫落。



- Material: Nylon 66 (UL)
- Flame Class: 94V-2/94V-0
- Color: Natural/Black
- Unit: mm

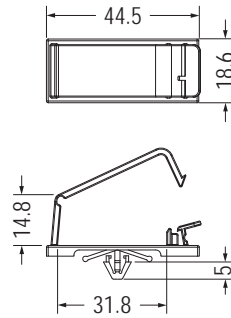

MOUNTING HOLE $\varnothing 6.5$
THICKNESS 0.8-1.6

Part No.	Package
FCJA-1	200



- Material: Nylon 66 (UL)
- Flame Class: 94V-2/94V-0
- Color: Natural/Black
- Unit: mm

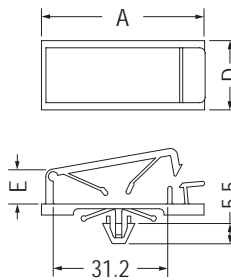

MOUNTING HOLE $\varnothing 6.5$
THICKNESS 0.5-2.2

Part No.	A	D	E	Package
FCJ-30	44.3	18.8	9.4	200
FCJ-30S	44.5	19.0	13.5	

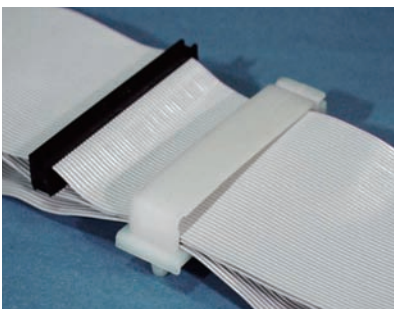

- Material: Nylon 66 (UL)
- Flame Class: 94V-2/94V-0
- Color: Natural/Black
- Unit: mm

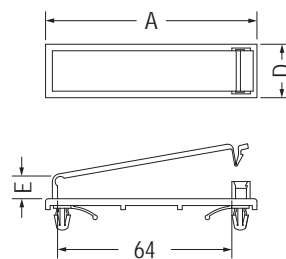

$\varnothing 4.8$
MOUNTING HOLE
THICKNESS 0.8-2.2

Part No.	A	D	E	Package
FCT-1	77.4	19.6	9.9	100
FCT-1L	77.0	20.0	15.0	

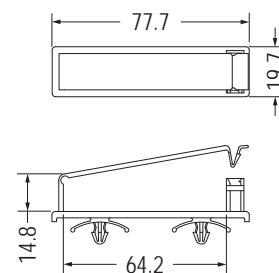

$\varnothing 4.8$
MOUNTING HOLE
THICKNESS 0.8-3.2

Part No.	Package
FCT-5	100

電線固定座 CABLE CLAMP

用途：用於電子、電腦內部電線固定，裝配容易，美觀不脫落。

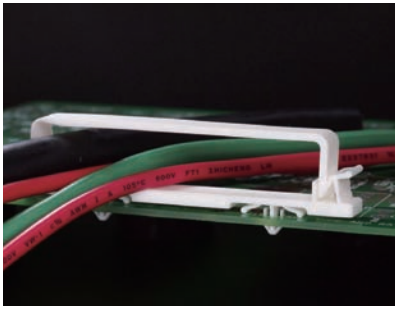

- Material: Nylon 66 (UL)
- Flame Class: 94V-2/94V-0
- Color: Natural/Black
- Unit: mm

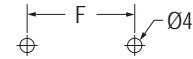
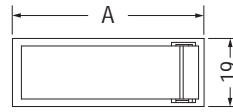

MOUNTING HOLE THICKNESS 0.8-2.2

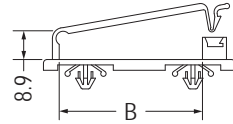

Part No.	A	B	F	Package
FCT-2	53.8	40.0	30.0	100
FCT-3	45.8	32.0	25.0	

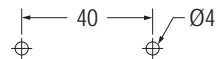
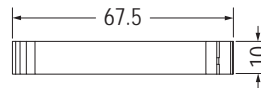

MOUNTING HOLE THICKNESS: T

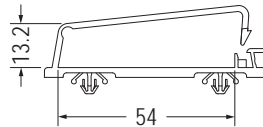

Part No.	T	Package
FCT-4	2.0	100
FCT-4S	0.8-1.0	
FCT-4M	0.8-2.0	

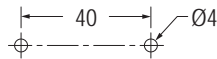
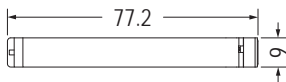

MOUNTING HOLE THICKNESS 0.8-2.2

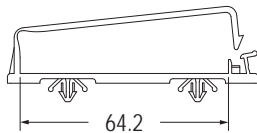

Part No.	Package
★FCT-15	200

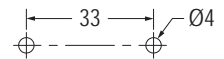
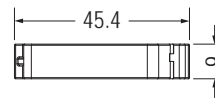

MOUNTING HOLE THICKNESS 0.8-2.2

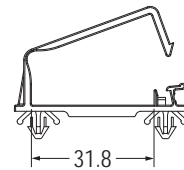

Part No.	Package
★FCT-16	250



- Material: Nylon 66 (UL)
- Flame Class: 94V-2/94V-0
- Color: Natural/Black
- Unit: mm

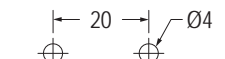
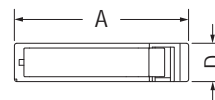

MOUNTING HOLE THICKNESS: T

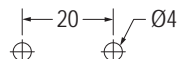
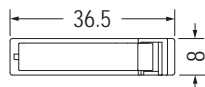

MOUNTING HOLE THICKNESS: T

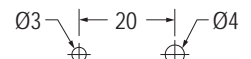
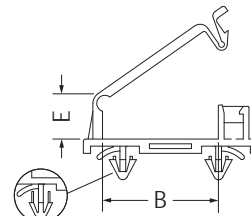
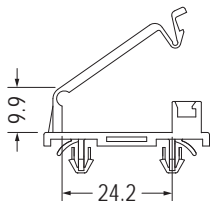

MOUNTING HOLE THICKNESS: T

【 FCT-6L, FCT-8L 】

【 FCT-12 】

Part No.	T	Package
FCTB-1	1.2-2.5	500
FCTB-2	1.2-3.25	100

Part No.	A	B	D	E	T	Package
FCT-6	36.0	24.2	8.0	9.9	0.8-1.2	100
FCT-6L	36.1	24.2	8.0	9.9	0.8-2.0	
FCT-8	40.0	28.3	7.9	11.4	0.8-1.2	
FCT-8L	40.0	28.3	7.9	11.4	1.2-2.5	
FCT-12	36.0	24.2	8.0	9.5	0.8-1.2	

電線固定座 CABLE CLAMP

用途：用於電子、電腦內部電線固定，
裝配容易，美觀不脫落。

- Material: Nylon 66 (UL)
- Flame Class: 94V-2/94V-0
- Color: Natural/Black
- Unit: mm

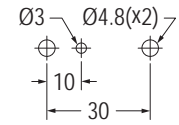
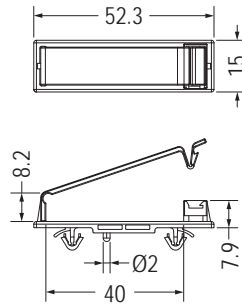

MOUNTING HOLE
THICKNESS 0.8-1.0

Part No.	Package
FCT-14	200

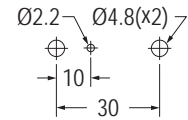
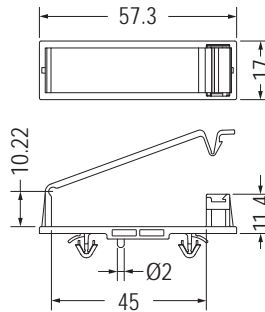

MOUNTING HOLE
THICKNESS 1.0

Part No.	Package
FCTG-1	200

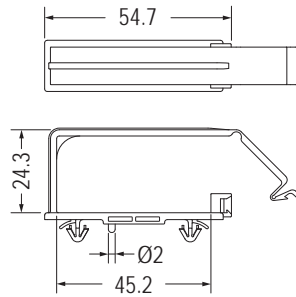

MOUNTING HOLE Ø4.8
THICKNESS 1.0

Part No.	Package
FCTE-1	100

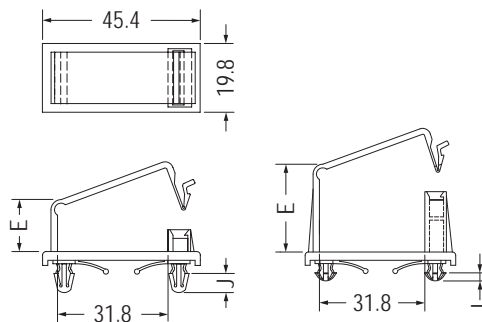

MOUNTING HOLE
THICKNESS 0.8-2.2

Part No.	E	J	Package
FCT-7	14.9	5.5	100
FCT-9	14.9	2.4	
FCT-9M	26.5	4.5	
FCT-11	26.5	2.4	

【 FCT-11 】

電線固定座 CABLE CLAMP

用途：用於電子、電腦內部電線固定，
裝配容易，美觀不脫落。



- Material: Nylon 66 (UL)
- Flame Class: 94V-2/94V-0
- Color: Natural/Black
- Unit: mm

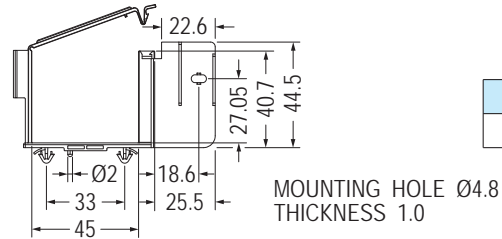
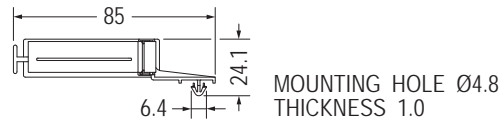

Part No.	Package
FCTF-1	50

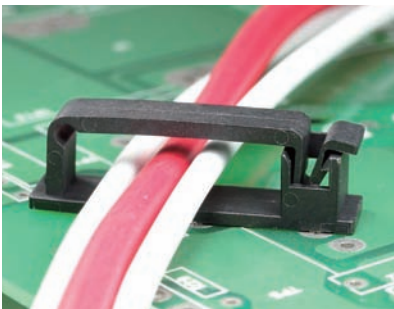

- Material: Nylon 66 (UL)
- Flame Class: 94V-2/94V-0
- Color: Natural/Black
- Unit: mm

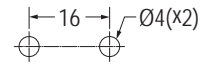
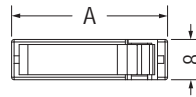

MOUNTING HOLE
THICKNESS: T

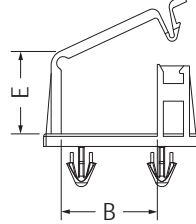

Part No.	A	B	E	T	Package
FCTC-1	31.0	19.1	16.1	3.0	100
FCTC-4	28.0	16.6	15.2	1.0	

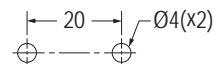
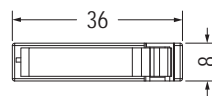

MOUNTING HOLE
THICKNESS 1.0

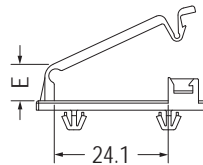

Part No.	E	Package
FCTC-5	7.7	100
★FCTC-6	9.8	

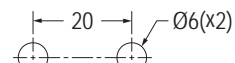
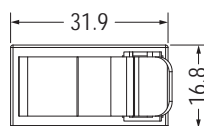

MOUNTING HOLE
THICKNESS 1.0

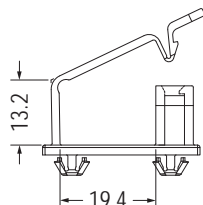

Part No.	Package
FCTC-2	200

電線固定座 CABLE CLAMP

用途：用於電子、電腦內部電線固定，
裝配容易，美觀不脫落。



- Material: Nylon 66 (UL)
- Flame Class: 94V-2/94V-0
- Color: Natural/Black
- Unit: mm

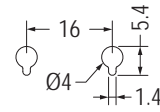
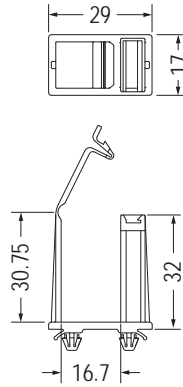

MOUNTING HOLE THICKNESS 0.8

Part No.	Package
FCTC-3	100



- Material: Nylon 66 (UL)
- Flame Class: 94V-2/94V-0
- Color: Natural/Black
- Unit: mm

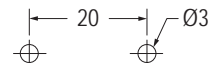
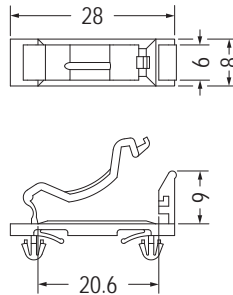

MOUNTING HOLE THICKNESS 0.8-1.2

Part No.	Package
WDT-20	500

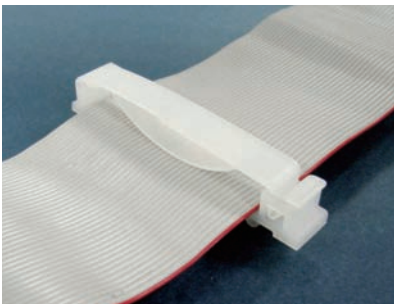

- Material: Nylon 66 (UL)
- Flame Class: 94V-2/94V-0
- Color: Natural/Black
- Unit: mm

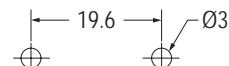
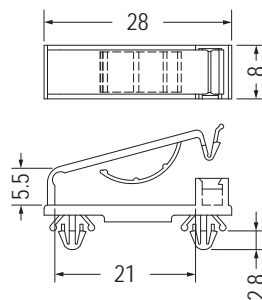

MOUNTING HOLE THICKNESS: T

Part No.	T	Package
FDT-2	0.8-1.2	1000
FDT-2-1.6	0.8-1.6	

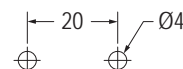
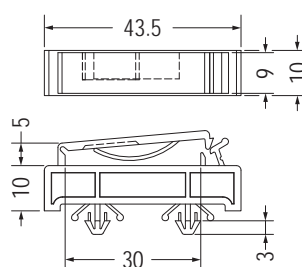

MOUNTING HOLE THICKNESS 0.8-2.0

Part No.	Package
FDT-3	500

電線固定座 CABLE CLAMP

用途：用於電子、電腦內部電線固定，
 裝配容易，美觀不脫落。

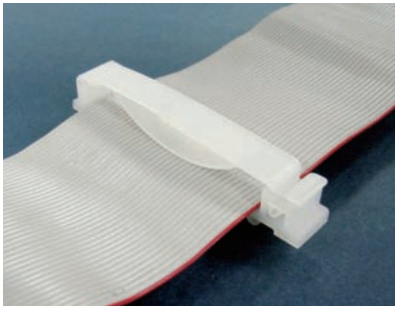

- Material: Nylon 66 (UL)
- Flame Class: 94V-2/94V-0
- Color: Natural/Black
- Unit: mm

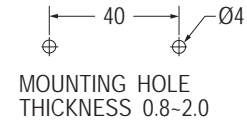
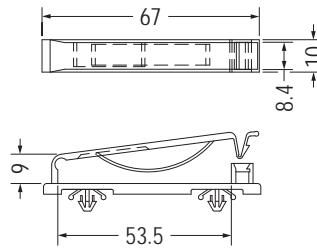

Part No.	Package
FDT-4	100

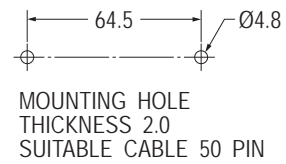
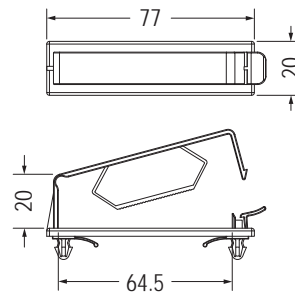

Part No.	Package
FCD-2	100

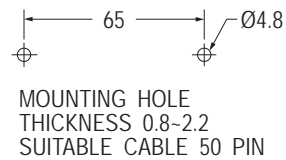
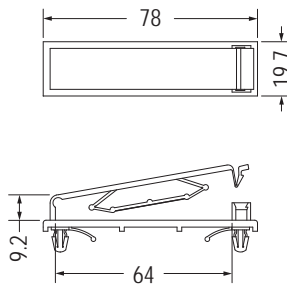

Part No.	Package
FCD-1	100

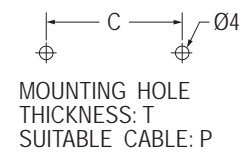
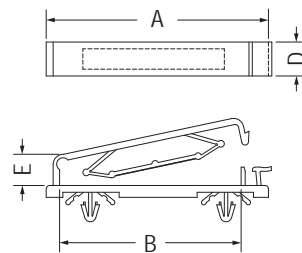

Part No.	A	B	C	D	E	T	P	Package
FCD-35	55.0	39.6	35.0	12.5	9.0	0.8~1.8	35 PIN	100
FCD-40	65.0	53.8	40.0	10.2	8.0	0.8~2.2	40 PIN	
FCD-50	77.0	64.3	49.7	10.0	9.2	0.8~2.0	50 PIN	

電線固定座 CABLE CLAMP

用途：固定電線於機殼上，方便堅固。



- Material: Nylon 66 (UL)
- Flame Class: 94V-2/94V-0
- Color: Natural/Black
- Unit: mm

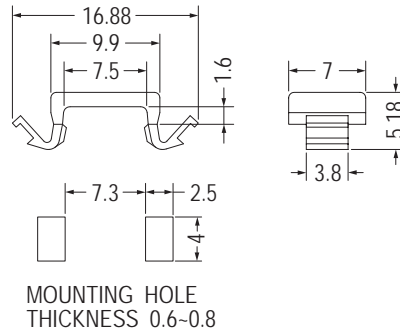

Part No.	Package
CCMH-7.5	1000

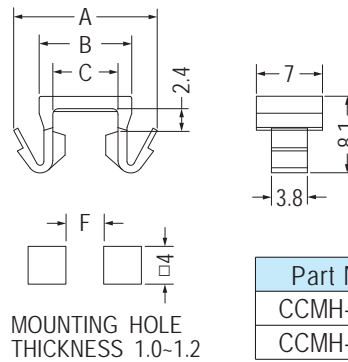

Part No.	A	B	C	F	Package
CCMH-12	15.2	9.8	6.8	4.0	1000
CCMH-15.1	18.1	12.9	10.0	7.1	

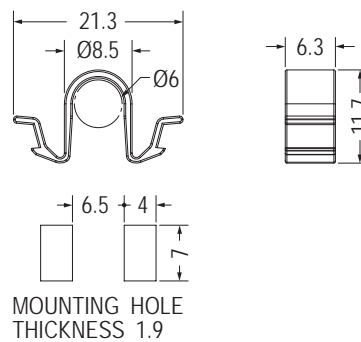

Part No.	Package
CCMHA-6	1000

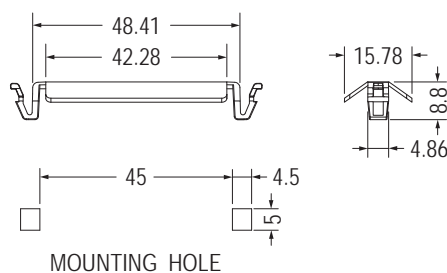

Part No.	Package
CCMH-50	500

電線固定座 CABLE CLAMP

用途：用於電子、電腦LCD-TV內部排線固定，裝配容易，美觀不脫落。

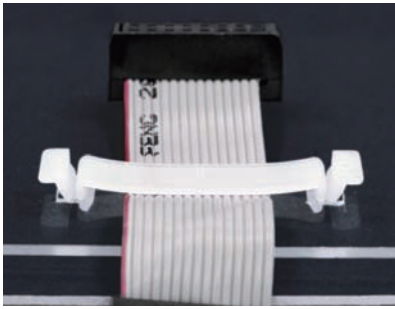

- Material: Nylon 66 (UL)
- Flame Class: 94V-2/94V-0
- Color: Natural/Black
- Unit: mm

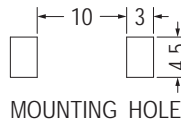
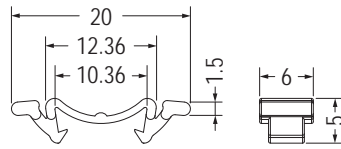

MOUNTING HOLE

Part No.	Package
CCMB-10	1000

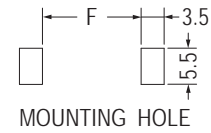
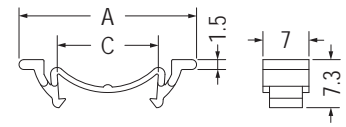

MOUNTING HOLE

Part No.	A	C	F	Package
CCMB-15	27.0	15.35	15.0	1000
CCMB-30	42.0	30.18	30.0	



- Material: PPO
- Color: Black

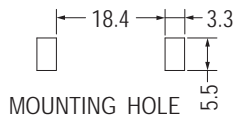
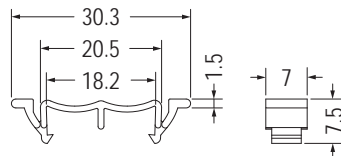

MOUNTING HOLE

Part No.	Package
CCMB-31	1000

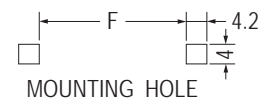
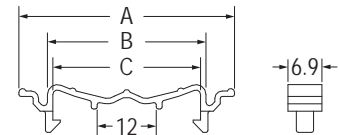

MOUNTING HOLE

Part No.	A	B	C	F	Package
CCMA-30	43.8	32.2	30.0	30.0	1000
CCMA-40	53.8	42.2	40.0	40.0	



- Material: Nylon 66 (UL)
- Flame Class: 94V-2/94V-0
- Color: Natural/Black
- Unit: mm

用途：可將電線固定於機殼上，電線不易磨損，配線整齊美觀。

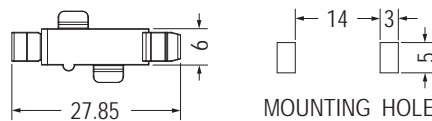

MOUNTING HOLE

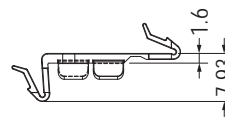

Part No.	Package
CCMD-1	1000

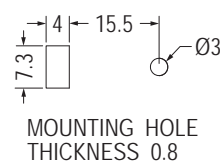

MOUNTING HOLE THICKNESS 0.8

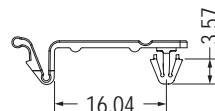

Part No.	Package
CCMC-1	1000

電線固定座 CABLE CLAMP

用途：背膠式，用於電子、電腦內部電線固定，裝配容易，美觀不脫落。

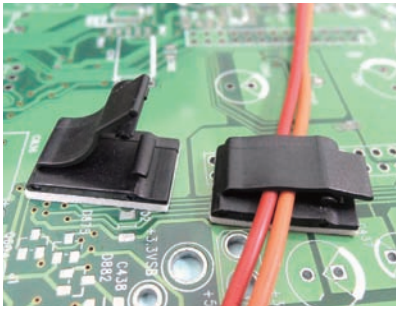

- Material: Nylon 66 (UL)
- Flame Class: 94V-2/94V-0
- Color: Natural/Black
- Unit: mm

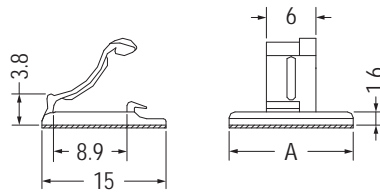

3M DOUBLE ADHESIVE TAPE

Part No.	A	Package
WDF-1	15.0	1000
WDF-3	6.0	

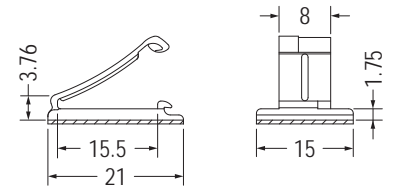

3M DOUBLE ADHESIVE TAPE

Part No.	Package
WDF-2	1000

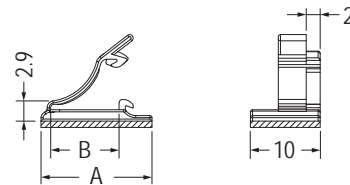

3M DOUBLE ADHESIVE TAPE

Part No.	A	B	Package
WDF-6	15.9	9.8	1000
WDF-7	17.6	11.5	

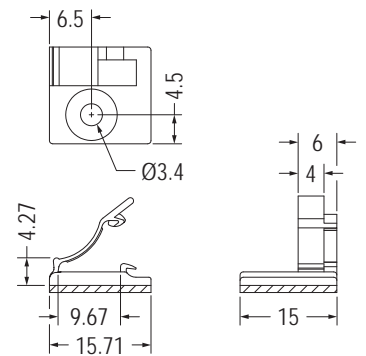

3M DOUBLE ADHESIVE TAPE

Part No.	Package
WDF-4	1000

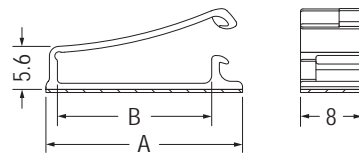
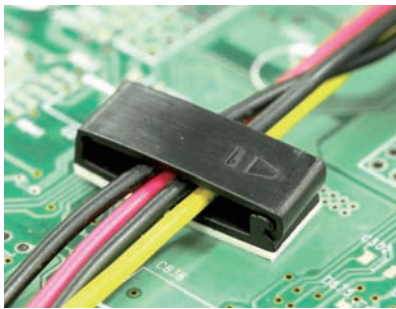

3M DOUBLE ADHESIVE TAPE

Part No.	A	B	Package
WDF-8	25.5	20.0	1000
WDF-9	35.5	30.0	

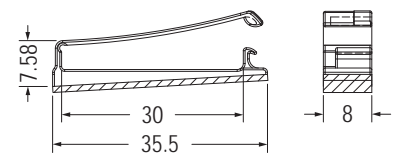

3M DOUBLE ADHESIVE TAPE

Part No.	Package
WDF-10	1000

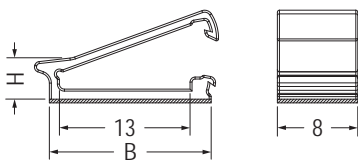

3M DOUBLE ADHESIVE TAPE

Part No.	B	H	Package
WCD-1	16.1	4.0	1000
WCD-4	17.0	8.0	

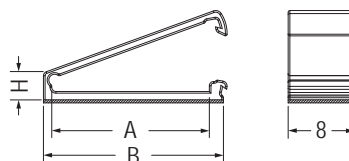

3M DOUBLE ADHESIVE TAPE

Part No.	A	B	H	Package
WCD-2	19.0	21.7	3.38	1000
WCD-3	18.5	21.85	4.87	

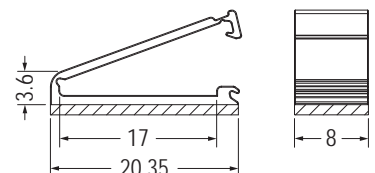

3M DOUBLE ADHESIVE TAPE

Part No.	Package
WCD-5	1000

電線固定座 CABLE CLAMP

用途：背膠式，可快速拆卸，固定電線維修方便，不佔空間。



- Material: Nylon 66 (UL)
- Flame Class: 94V-2/94V-0
- Color: Natural/Black
- Unit: mm

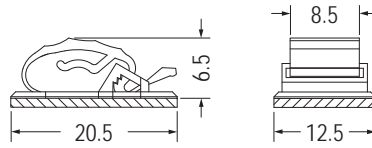

3M DOUBLE ADHESIVE TAPE

Part No.	Package
WCA-1	1000

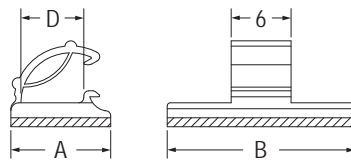
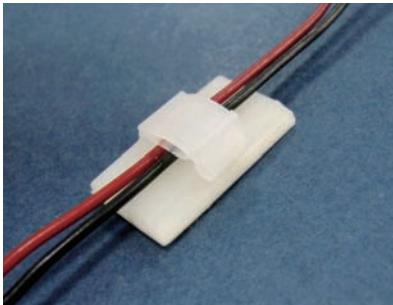

3M DOUBLE ADHESIVE TAPE

Part No.	A	B	D	Package
WCC-1	10.0	19.0	6.3	1000
WCC-1S	10.0	11.0	6.3	
WCC-2	14.0	19.0	10.5	500
WCC-8	10.0	19.5	6.0	1000

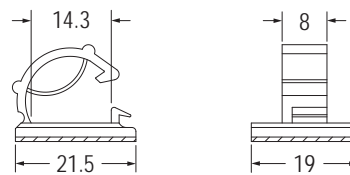

3M DOUBLE ADHESIVE TAPE

Part No.	Package
WCC-3	500

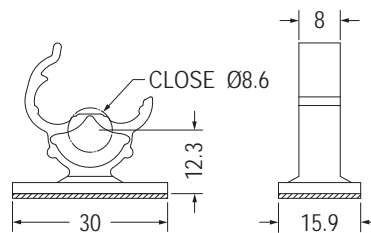

3M DOUBLE ADHESIVE TAPE

Part No.	Package
WSK-1	250

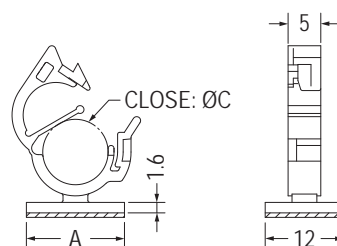
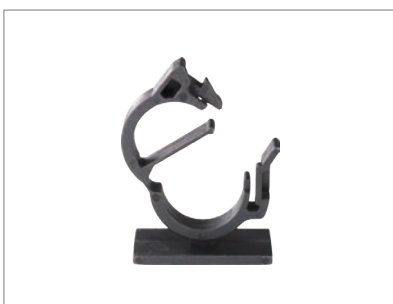

3M DOUBLE ADHESIVE TAPE

Part No.	A	C	Package
CHO-7.6	15.0	7.6	500
CHO-10	19.0	10.0	
CHO-12	20.0	12.0	

電線固定座 CABLE CLAMP

用途：小型化，背膠式，可快速捆紮及解開電線。

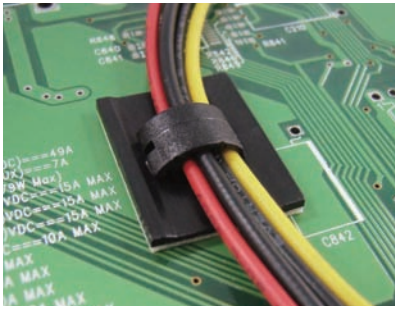

- Material: Nylon 66 (UL)
- Flame Class: 94V-2/94V-0
- Color: Natural/Black
- Unit: mm

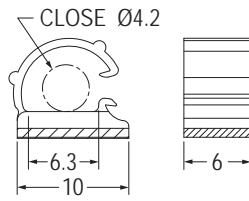

3M DOUBLE ADHESIVE TAPE

Part No.	Package
WCC-5	1000

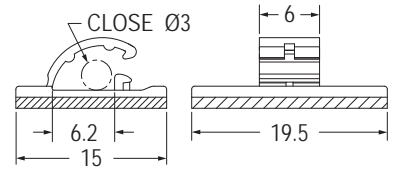

3M DOUBLE ADHESIVE TAPE

Part No.	Package
WCC-6	1000

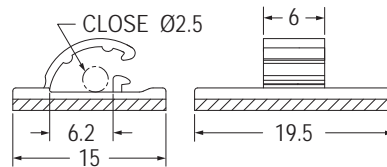
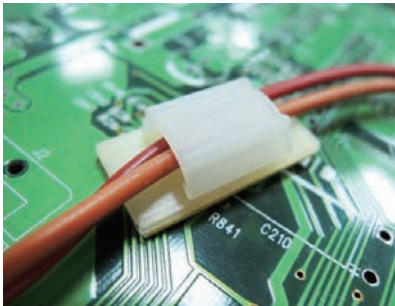

3M DOUBLE ADHESIVE TAPE

Part No.	Package
WCC-7	1000

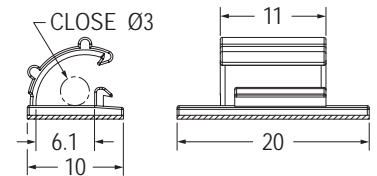

3M DOUBLE ADHESIVE TAPE

Part No.	Package
WCC-9	500



- Material: Nylon 66 (UL)
- Flame Class: 94V-2/94V-0
- Color: Natural/Black
- Unit: mm

用途：固定電線於機板上，維修方便，不佔空間。

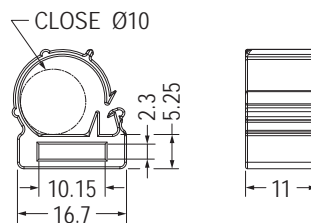

Part No.	Package
MISD-1	500

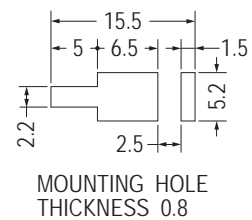
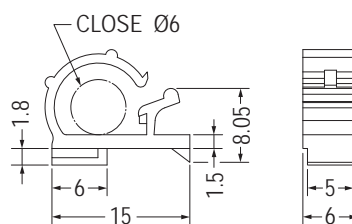

Part No.	Package
MISA-3	1000

電線固定座 CABLE CLAMP

用途：背膠式，可快速拆卸，固定電線維修方便，不佔空間。

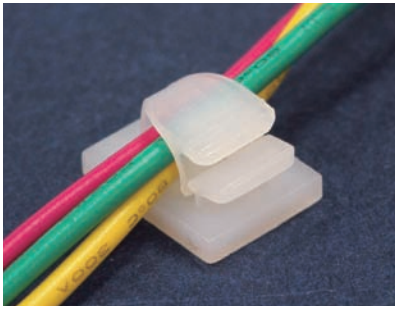

- Material: Nylon 66 (UL)
- Flame Class: 94V-2/94V-0
- Color: Natural/Black
- Unit: mm

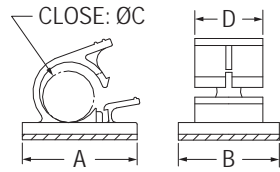

3M DOUBLE ADHESIVE TAPE

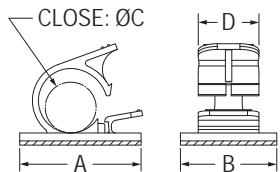
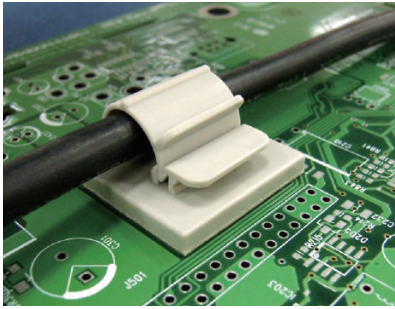

3M DOUBLE ADHESIVE TAPE

【FWU-11】

Part No.	A	B	C	D	Package
FWU-1	13.0	10.0	4.0	6.8	1000
FWU-2	15.0	13.0	6.0	9.0	
FWU-3	21.6	19.0	9.0	12.8	500
FWU-4	25.0	20.0	11.0	13.2	250
FWU-5	32.0	25.4	13.4	16.0	200
FWU-6	35.8	24.8	18.0	16.8	100
FWU-7	56.1	50.0	25.4	20.1	50
FWU-8	56.1	50.0	30.0	20.1	
FWU-9	37.6	31.5	18.0	17.0	100
FWU-10	31.0	19.0	9.0	12.8	200
FWU-11	13.0	10.0	5.0	6.8	1000

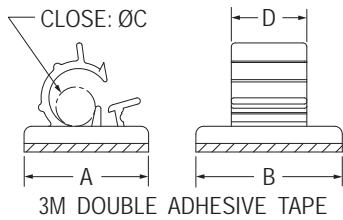

3M DOUBLE ADHESIVE TAPE

Part No.	A	B	C	D	Package
FWAS-1	16.4	19.3	5.0	9.7	500
FWAS-2	25.3	25.4	11.0	16.1	250
FWAS-3	37.0	29.3	19.6	16.9	100
FWAS-4	57.1	50.5	26.8	31.7	50
FWAS-5	22.1	25.4	6.35	16.0	250
FWAS-6	30.73	25.4	12.7	16.26	100

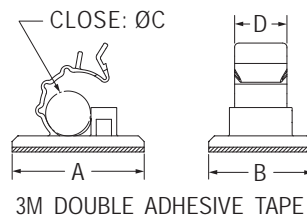

3M DOUBLE ADHESIVE TAPE

Part No.	A	B	C	D	Package
FWC-6	17.5	20.5	6.2	8.6	200
FWC-7	25.5	17.5	7.0	9.8	
FWC-10	30.3	23.9	10.3	12.0	
FWC-10S	30.0	21.0	10.0	12.0	
FWC-15	29.9	23.9	14.5	14.0	
FWC-19	35.7	25.2	18.5	15.9	

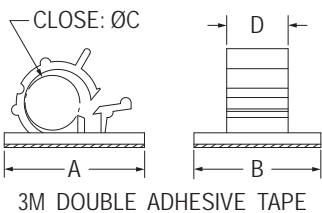

3M DOUBLE ADHESIVE TAPE

Part No.	A	B	C	D	Package
FWS-1	21.0	19.0	8.2	9.2	500
FWS-2	25.0	20.0	9.0	12.0	250
FWS-3	25.0	19.7	10.6	12.1	
FWS-4	29.0	20.0	12.6	14.0	
FWS-7	29.6	19.5	12.8	14.8	
FWS-8	21.6	17.0	10.4	12.0	
FWS-10	19.0	19.0	6.8	8.8	500

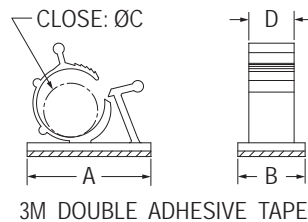

3M DOUBLE ADHESIVE TAPE



Part No.	A	B	C	D	Package	UL
AWC-1	24.8	18.8	7.9-10.3	10.2	250	UL
AWC-2	25.4	15.0	11.0-13.3	10.0		UL
AWC-2A	30.2	15.0	11.9-14.3	10.0		
AWC-3	34.4	18.8	14.7-19.1	12.7	100	UL
AWC-4	36.0	19.0	18.0-22.0	12.7		UL
AWC-5	39.8	19.8	22.0-26.5	13.0		UL
AWC-6	31.8	19.1	11.9-14.3	10.2	250	

電線固定座 CABLE CLAMP

用途：固定電線於PC板或機板上，維修方便，不佔空間。



- Material: Nylon 66 (UL)
- Flame Class: 94V-2/94V-0
- Color: Natural/Black
- Unit: mm

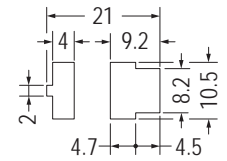
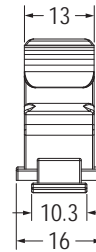
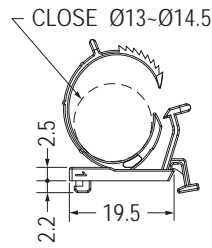

MOUNTING HOLE THICKNESS 0.8-1.0

Part No.	Package
AWE-1	500

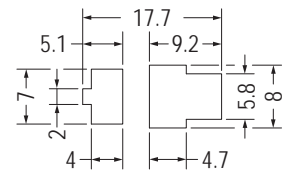
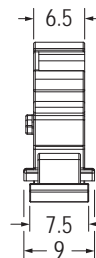
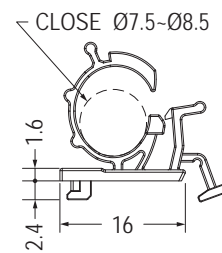

MOUNTING HOLE THICKNESS 0.9-1.1

Part No.	Package
AWE-2	500

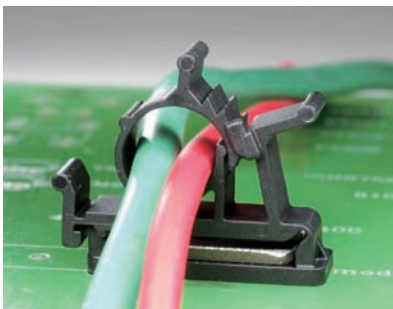

- Material: Nylon 66 (UL)
- Flame Class: 94V-2/94V-0
- Color: Natural/Black
- Unit: mm

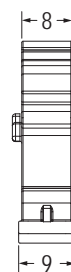
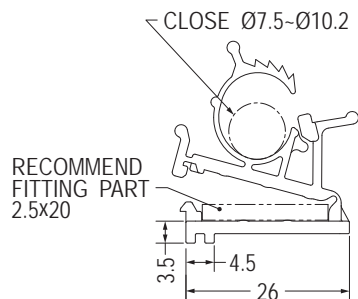

Part No.	Package
AWB-1	500

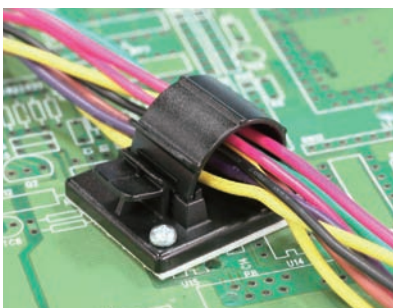

- Material: Nylon 66 (UL)
- Flame Class: 94V-2/94V-0
- Color: Natural/Black
- Unit: mm

用途：背膠式，亦可配合螺絲，固定電線，美觀不脫落。

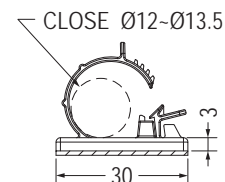
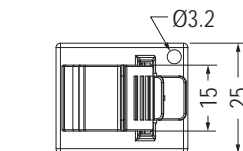

3M DOUBLE ADHESIVE TAPE

Part No.	Package
FWD-1	1000

電線固定座 CABLE CLAMP

用途：配合螺絲，固定電線，美觀不脫落。

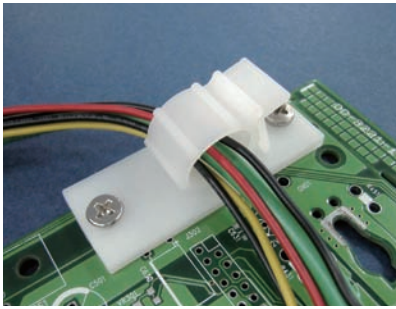

- Material: Nylon 66 (UL)
- Flame Class: 94V-2/94V-0
- Color: Natural/Black
- Unit: mm

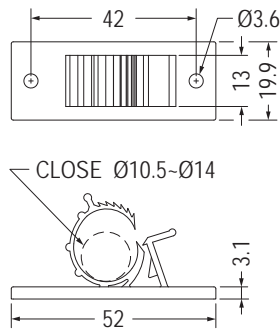

Part No.	Package
AWCA-1	1000



- Material: Nylon 66 (UL)
- Flame Class: 94V-2/94V-0
- Color: Natural/Black
- Unit: mm

用途：用於機器上之電線固定。

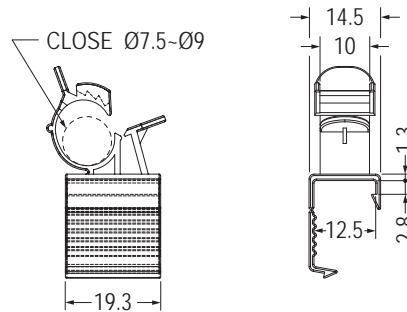

Part No.	Package
AWCB-1	500



- Material: Nylon 66 (UL)
- Flame Class: 94V-2/94V-0
- Color: Natural/Black
- Unit: mm

用途：背膠式，可快速拆卸，固定電線維修方便，不佔空間。

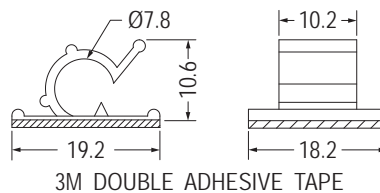

3M DOUBLE ADHESIVE TAPE

Part No.	Package
WC-1	500

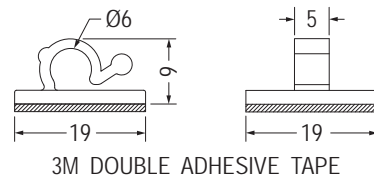

3M DOUBLE ADHESIVE TAPE

Part No.	Package
WRA-6	1000

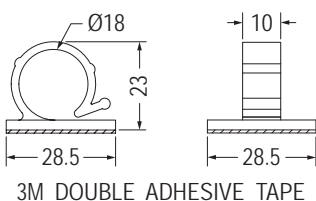

3M DOUBLE ADHESIVE TAPE

Part No.	Package
WRA-18	500

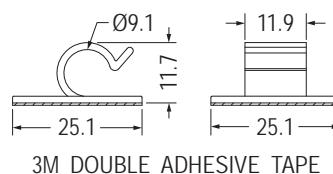

3M DOUBLE ADHESIVE TAPE

Part No.	Package
WCL-30	500

電線固定座 WIRE CLIP

用途：背膠式，固定電線於機器中，整齊美觀。



- Material: Nylon 66 (UL)
- Flame Class: 94V-2/94V-0
- Color: Natural/Black
- Unit: mm

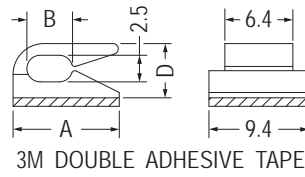

Part No.	A	B	D	Package
WC-6	10.0	4.3	5.1	1000
WC-7	12.0	6.25	5.5	

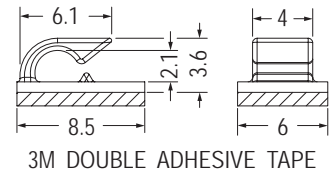

Part No.	Package
WC-12	1000

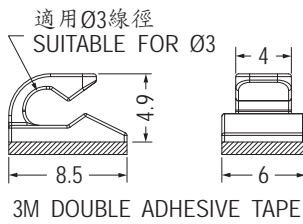

Part No.	Package
MWS-37	1000

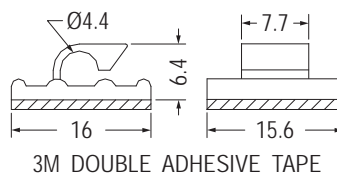

Part No.	Package
WC-5	1000

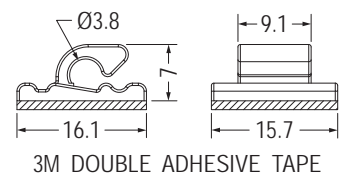

Part No.	Package
WC-10	1000

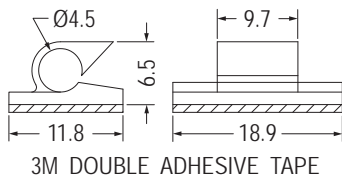

Part No.	Package
WCL-11	1000

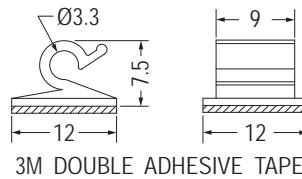

Part No.	Package
WCL-12	1000

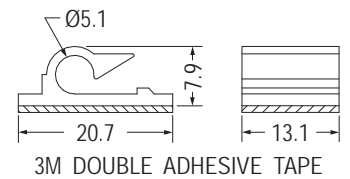

Part No.	Package
WCL-1	500

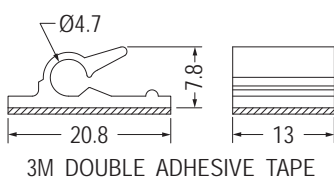

Part No.	Package
WCL-13	1000

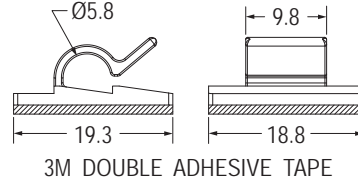

Part No.	Package
WCL-15	500

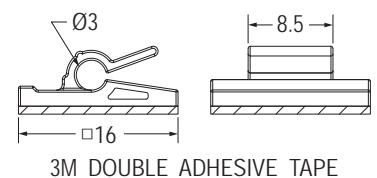

Part No.	Package
WCL-29	1000

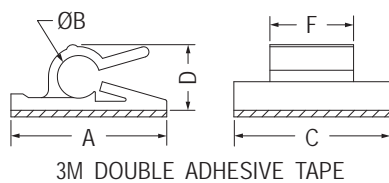

Part No.	A	B	C	D	F	Package
WCT-4	15.9	4.0	15.9	5.7	9.7	500
WCT-5	19.0	5.2	19.0	8.0	10.2	
WCT-6	19.0	6.0	20.0	9.9	10.0	

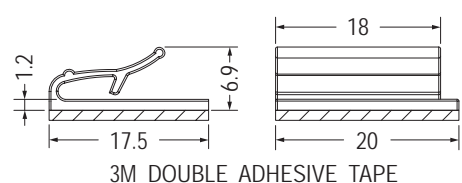

Part No.	Package
WCL-23	500

電線固定座 WIRE CLIP

用途：背膠式，固定電線於機器中，整齊美觀。

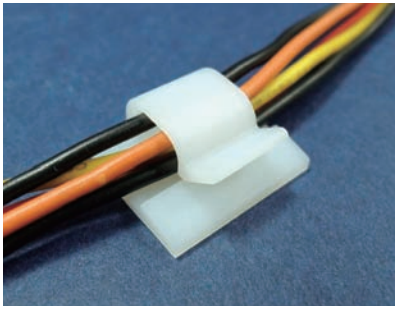

- Material: Nylon 66 (UL)
- Flame Class: 94V-2/94V-0
- Color: Natural/Black
- Unit: mm

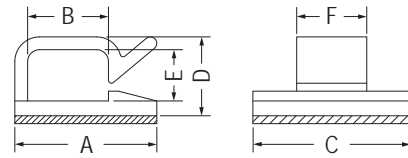

3M DOUBLE ADHESIVE TAPE

Part No.	A	B	C	D	E	F	Package
WCL-4	14.4	8.2	16.0	8.0	5.2	7.1	1000
WCL-5	16.8	10.2	16.0	9.5	6.7	7.0	500
WCL-7	20.8	13.6	19.0	11.3	8.2	9.0	1000
WCL-14	15.4	9.9	16.0	7.3	4.7	7.0	1000
WCL-27	20.1	15.8	16.0	9.3	6.5	9.0	500
WCL-28	22.7	18.0	20.0	8.7	6.0	10.0	500

4

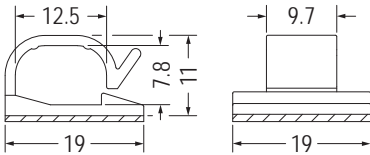

3M DOUBLE ADHESIVE TAPE

Part No.	Package
WCL-6	500

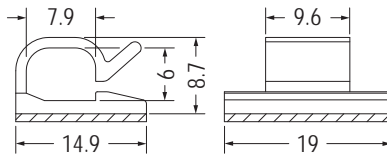

3M DOUBLE ADHESIVE TAPE

Part No.	Package
WCL-18	1000

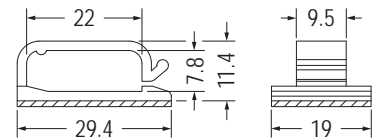

3M DOUBLE ADHESIVE TAPE

Part No.	Package
WCL-31	500

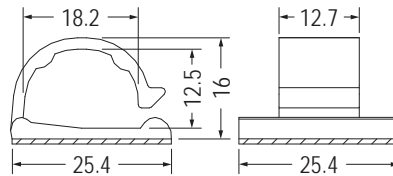

3M DOUBLE ADHESIVE TAPE

Part No.	Package
WCL-10	250

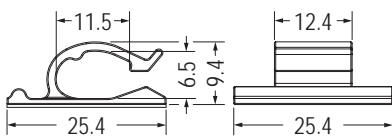

3M DOUBLE ADHESIVE TAPE

Part No.	Package
WCL-24	500

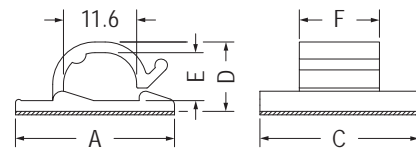

3M DOUBLE ADHESIVE TAPE

Part No.	A	C	D	E	F	Package
WCL-8	25.4	15.5	11.3	7.8	6.5	500
WCL-9	25.2	25.2	11.0	7.6	12.7	500

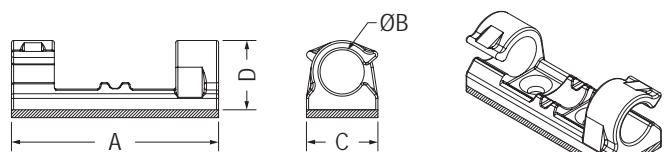

3M DOUBLE ADHESIVE TAPE

Part No.	A	B	C	D	Package
WCL-25	29.0	6.2	10.0	9.7	500
WCL-26	33.0	9.0	13.0	12.7	500

電線固定座 WIRE SADDLE

用途：背膠式，可快速拆卸，固定電線
維修方便，整齊美觀，不佔空間。

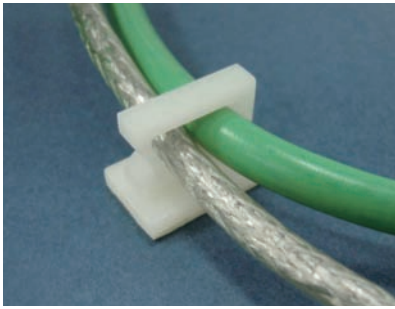

- Material: Nylon 66 (UL)
- Flame Class: 94V-2/94V-0
- Color: Natural/Black
- Unit: mm

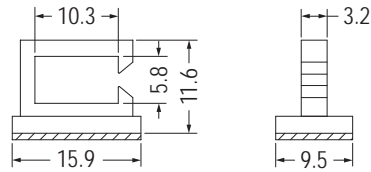

3M DOUBLE ADHESIVE TAPE

Part No.	Package
WSS-1	1000

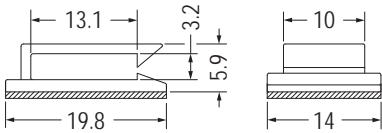

3M DOUBLE ADHESIVE TAPE

Part No.	Package
MWS-30	1000

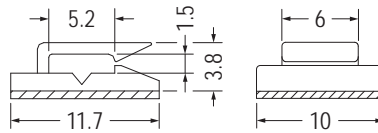

3M DOUBLE ADHESIVE TAPE

Part No.	Package
WCLA-1	1000

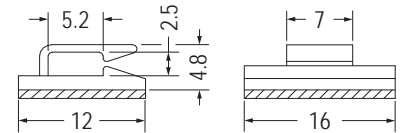

3M DOUBLE ADHESIVE TAPE

Part No.	Package
WC-4	1000

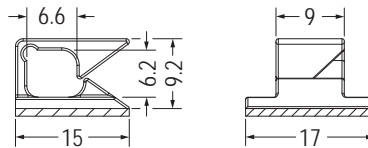
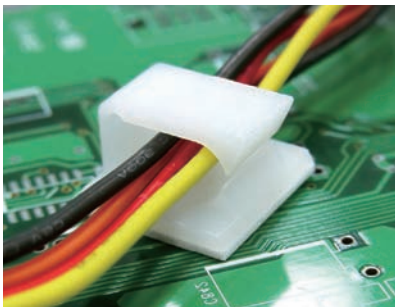

3M DOUBLE ADHESIVE TAPE

Part No.	Package
WSB-4	1000

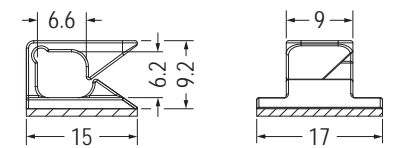

3M DOUBLE ADHESIVE TAPE

Part No.	Package
WSB-6	1000

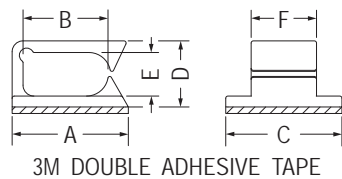

3M DOUBLE ADHESIVE TAPE

Part No.	A	B	C	D	E	F	Package
WSB-1	12.0	6.2	12.1	6.3	3.6	9.1	1000
WSB-2	16.0	11.7	16.0	9.1	6.0	9.0	
WSB-3	14.1	7.6	15.8	9.1	6.1	9.0	
WSB-5	14.0	10.5	12.1	6.25	3.5	10.0	

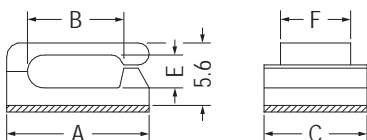

3M DOUBLE ADHESIVE TAPE

Part No.	A	B	C	E	F	Package
MWS-2	13.0	8.5	9.2	3.0	6.3	1000
MWS-3	16.0	11.5	13.0	2.9	9.0	

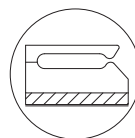

【 MWS-46L 】

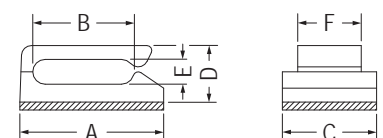

3M DOUBLE ADHESIVE TAPE

Part No.	A	B	C	D	E	F	Package
MWS-2D	14.5	10.2	9.5	5.7	2.5	6.4	1000
MWS-27	12.5	8.4	9.5	5.2	2.8	6.5	
MWS-45	12.7	8.1	12.7	5.0	2.5	6.4	
MWS-46	9.8	6.65	9.5	3.85	1.4	6.4	
MWS-46L	9.7	6.45	9.5	4.5	1.4	6.4	

電線固定座 WIRE SADDLE

用途：背膠式，可快速拆卸，固定電線
維修方便，整齊美觀，不佔空間。

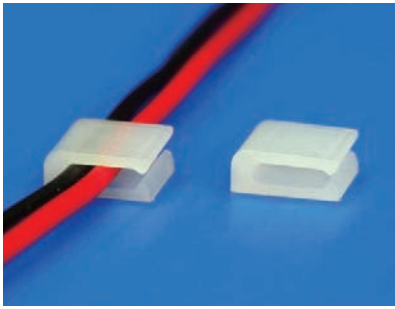

- Material: Nylon 66 (UL)
- Flame Class: 94V-2/94V-0
- Color: Natural/Black
- Unit: mm

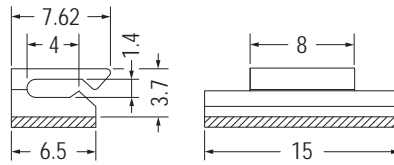

3M DOUBLE ADHESIVE TAPE

Part No.	Package
MWS-22	1000

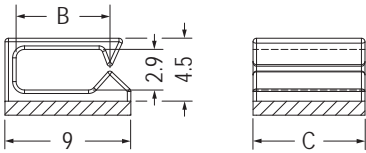

3M DOUBLE ADHESIVE TAPE

Part No.	B	C	Package
MWS-32	6.7	8.0	1000
MWS-42	6.73	4.0	

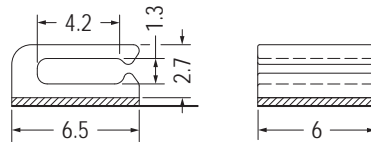

3M DOUBLE ADHESIVE TAPE
WITH RELEASE TAB 易撕型背膠

Part No.	Package
MWS-52	1000

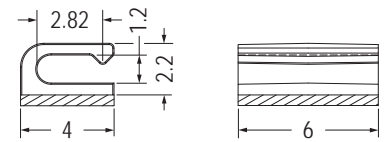

3M DOUBLE ADHESIVE TAPE

Part No.	Package
MWS-43	1000

4

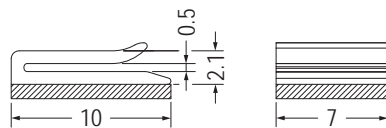

3M DOUBLE ADHESIVE TAPE

Part No.	Package
MWS-33	1000

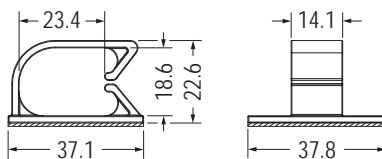

3M DOUBLE ADHESIVE TAPE

Part No.	Package
MWS-54	100

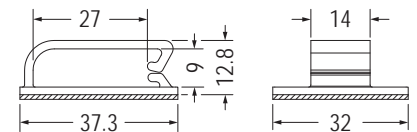

3M DOUBLE ADHESIVE TAPE

Part No.	Package
MWS-49	250

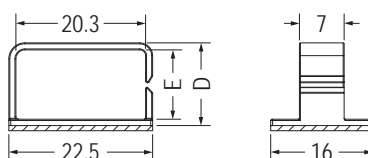

3M DOUBLE ADHESIVE TAPE

Part No.	D	E	Package
MWS-61	12.95	10.85	500
MWS-62	16.85	14.85	



電線固定座 WIRE CLIP

用途：可背膠或使用螺絲固定，可快速拆卸，固定電線維修方便，不佔空間。

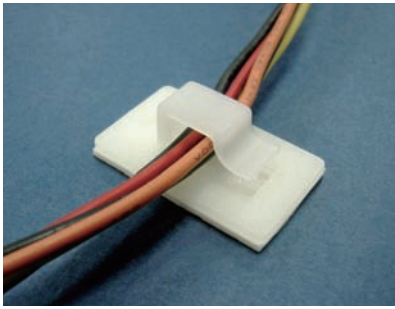

- Material: Nylon 66 (UL)
- Flame Class: 94V-2/94V-0
- Color: Natural/Black
- Unit: mm

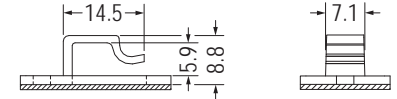
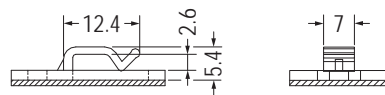
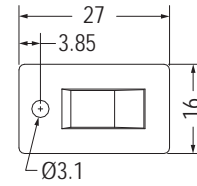
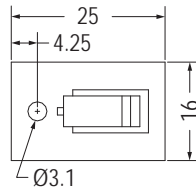

3M DOUBLE ADHESIVE TAPE

3M DOUBLE ADHESIVE TAPE

Part No.	Package
WCS-1	500

Part No.	Package
WCS-2	500

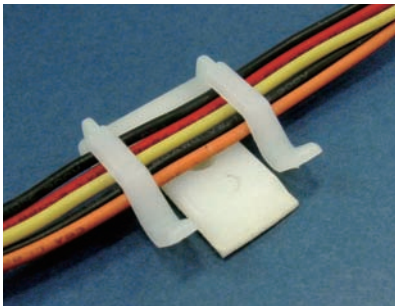

- Material: Nylon 66 (UL)
- Flame Class: 94V-2/94V-0
- Color: Natural/Black
- Unit: mm

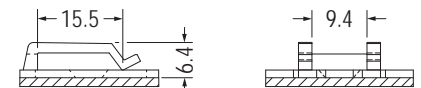
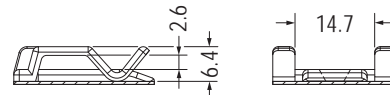
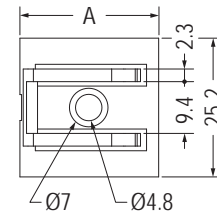
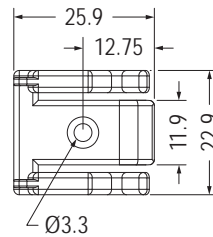

3M DOUBLE ADHESIVE TAPE

3M DOUBLE ADHESIVE TAPE

Part No.	Package
FCP-25	500

Part No.	A	Package
FCP-22	25.2	500
FCP-22S	24.2	



- Material: Nylon 66 (UL)
- Flame Class: 94V-2/94V-0
- Color: Natural/Black
- Unit: mm

用途：背膠式，可快速拆卸，固定電線維修方便，不佔空間。

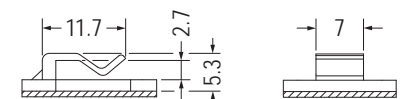
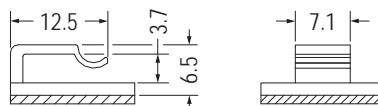
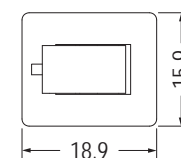
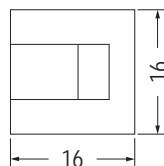

3M DOUBLE ADHESIVE TAPE

3M DOUBLE ADHESIVE TAPE

Part No.	Package
WCS-3	500

Part No.	Package
WCS-4	500

電線固定座 WIRE CLIP

用途：背膠式，可快速拆卸，固定電線維修方便，不佔空間。

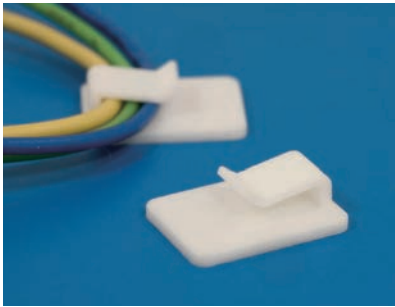

- Material: Nylon 66 (UL)
- Flame Class: 94V-2/94V-0
- Color: Natural/Black
- Unit: mm

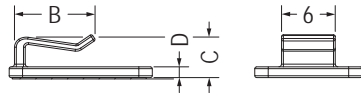
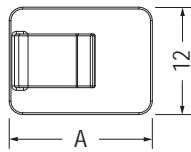

DOUBLE ADHESIVE TAPE
RELEASE TAB 易撕型背膠

Part No.	A	B	C	D	Package
MIBB-10	16.0	9.0	4.5	1.2	500
MIBB-14	16.0	9.0	6.1	3.0	
MIBB-18	14.0	7.6	4.0	0.8	

4

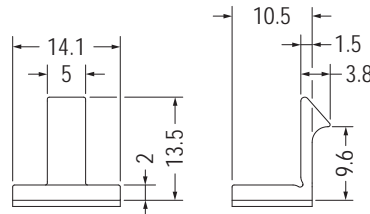
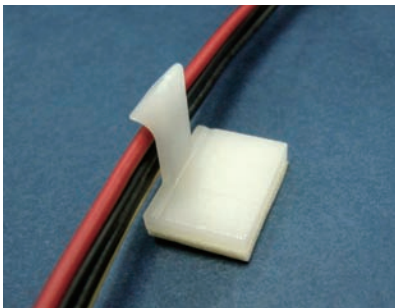

3M DOUBLE ADHESIVE TAPE

Part No.	Package
WCLL-1	500

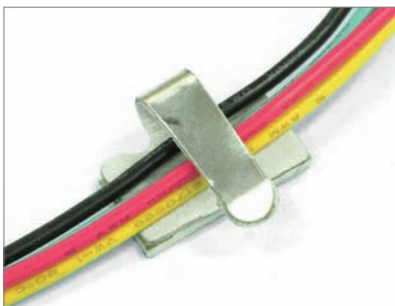

- Material: Steel
- Unit: mm

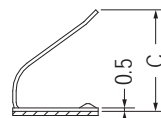
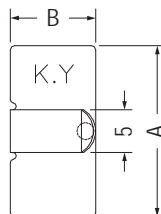

3M DOUBLE ADHESIVE TAPE

用途：背膠式，可快速捆紮電線安裝容易，經特殊處理，不刮手，不會刮傷電線。

Part No.	A	B	C	Package
WCM-1	20.0	10.0	11.6	1000
WCM-2	25.0	15.0	17.1	500

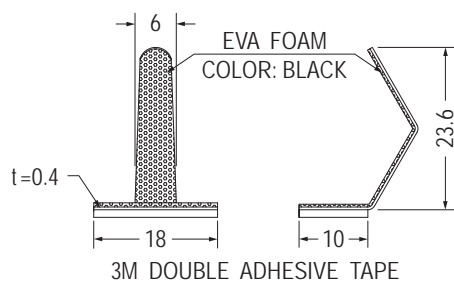

- Material: SPTE

Part No.	Package
WCM-5L	1000

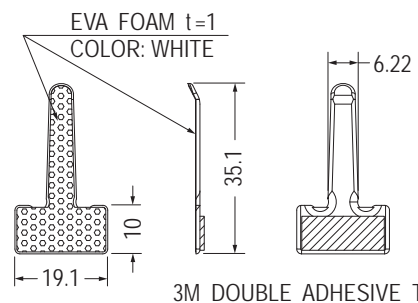

- Material: SPTE

Part No.	Package
WCM-9A	1000

電線固定板 WIRE CLIP

用途：背膠式，用於電線或零件之固定。

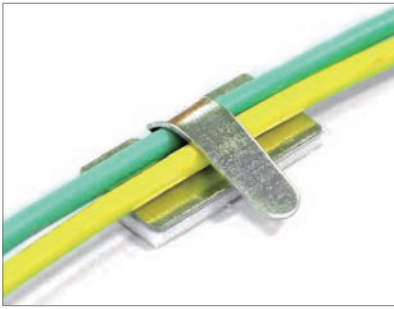

- Material: Aluminum
- Unit: mm

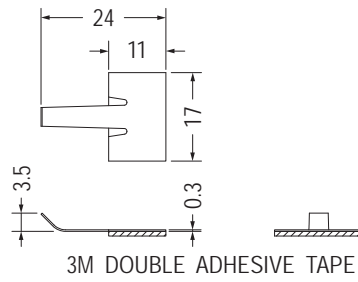

Part No.	Package
WCM-11	1000

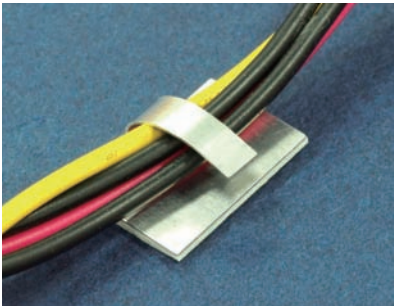

- Material: SPTe
- Unit: mm

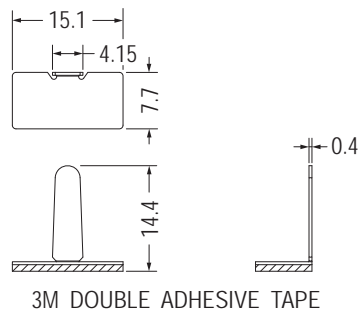

Part No.	Package
WCM-10	1000

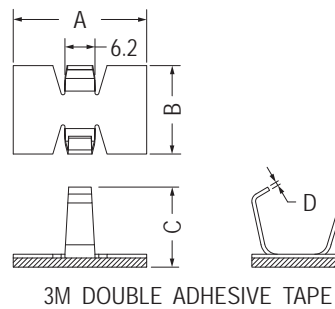
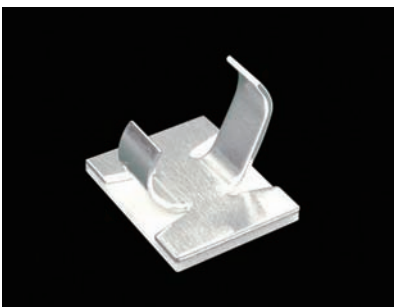

Part No.	A	B	C	D	Package
ALACO-01	16.0	10.6	9.4	0.45	500
ALACO-02	19.0	16.0	14.9	0.7	

電線固定座 WIRE SADDLE

用途：背膠式，可快速拆卸，固定電線維修方便，不佔空間。



- Material: Nylon 66 (UL)
- Flame Class: 94V-2/94V-0
- Color: Natural/Black
- Unit: mm

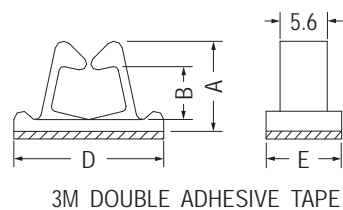

Part No.	A	B	D	E	Package
WT-2	10.7	6.3	17.8	8.9	1000
WT-2L	10.8	6.5	25.5	12.6	

電線固定座 WIRE SADDLE

用途：背膠式，可快速拆卸，固定電線維修方便，不佔空間。

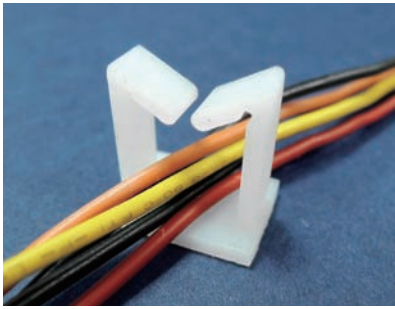

- Material: Nylon 66 (UL)
- Flame Class: 94V-2/94V-0
- Color: Natural/Black
- Unit: mm

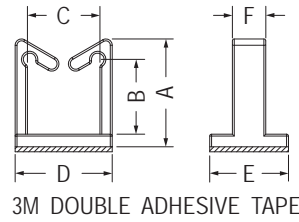

3M DOUBLE ADHESIVE TAPE

【 WT-5, WT-8, WT-12 】

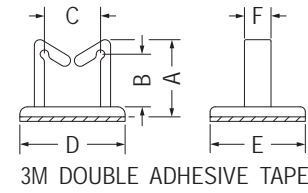

3M DOUBLE ADHESIVE TAPE

【 WT-9 】

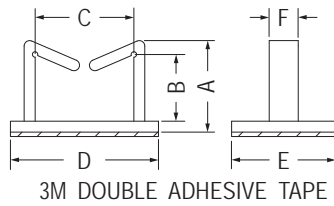

3M DOUBLE ADHESIVE TAPE

Part No.	A	B	C	D	E	F	Package
WT-1	17.2	12.2	11.5	21.0	19.0	5.3	500
WT-3	16.7	12.16	18.0	27.0	19.0	5.3	
WT-4	26.0	21.2	11.5	21.0	19.0	5.3	
WT-5	17.1	11.5	11.5	15.4	12.5	5.3	
WT-6	17.0	12.17	11.5	17.0	12.5	5.3	
WT-8	17.5	12.7	16.5	20.5	19.0	7.0	
WT-9	15.4	10.5	11.2	21.0	19.0	5.3	
★WT-12	26.0	22.0	11.5	15.5	19.0	5.3	

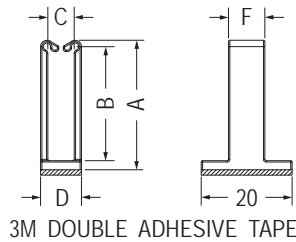

3M DOUBLE ADHESIVE TAPE

Part No.	A	B	C	D	F	Package
WT-7	28.5	25.1	5.8	9.0	8.0	500
WT-10	19.2	15.45	6.8	10.0	5.0	



- Material: Nylon 66 (UL)
- Flame Class: 94V-2/94V-0
- Color: Natural/Black
- Unit: mm

用途：超小型，背膠式，可快速固定及解開電線。

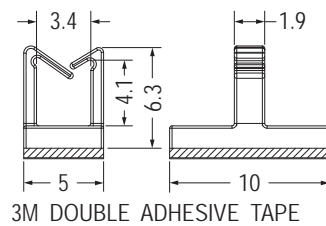

3M DOUBLE ADHESIVE TAPE

Part No.	Package
WLL-19	1000

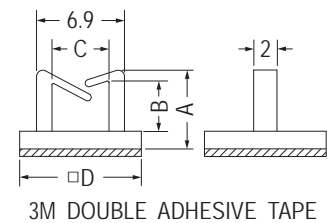

3M DOUBLE ADHESIVE TAPE

Part No.	A	B	C	D	Package
WLL-1	6.5	3.8	4.5	9.6	1000
WLL-1S	6.2	4.23	4.3	9.6	
WLL-13	6.2	4.23	4.3	8.5	
WLL-16	6.5	4.3	4.5	9.5	

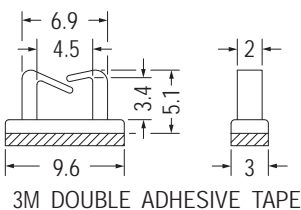

3M DOUBLE ADHESIVE TAPE

Part No.	Package
WLL-14	1000

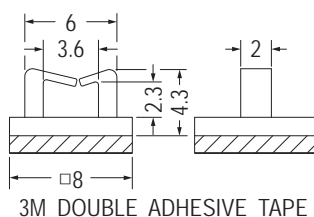

3M DOUBLE ADHESIVE TAPE

Part No.	Package
WLL-20	1000

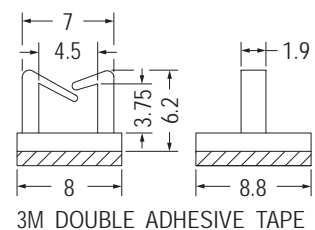

3M DOUBLE ADHESIVE TAPE

Part No.	Package
WLL-24	1000

電線固定座 WIRE SADDLE

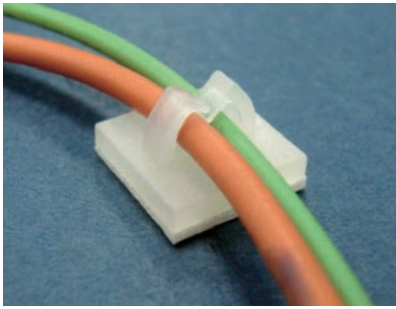

- Material: Nylon 66 (UL)
- Flame Class: 94V-2/94V-0
- Color: Natural/Black
- Unit: mm

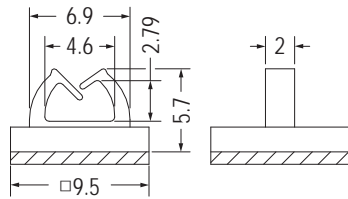

3M DOUBLE ADHESIVE TAPE

Part No.	Package
WLL-2	1000

用途：超小型，背膠式，可快速固定及解開電線。

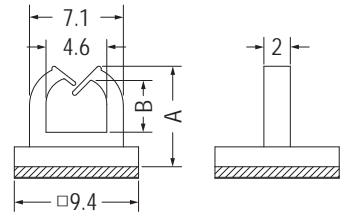

3M DOUBLE ADHESIVE TAPE

Part No.	A	B	Package
WLL-6	7.6	3.94	1000
WLL-6L	9.3	5.64	

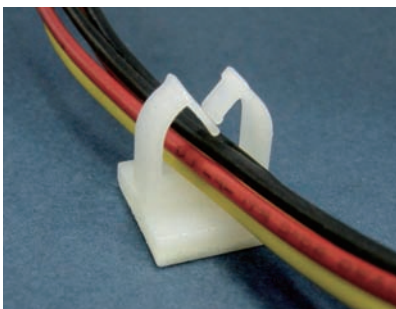

- Material: Nylon 66 (UL)
- Flame Class: 94V-2/94V-0
- Color: Natural/Black
- Unit: mm

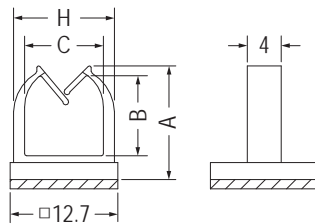

3M DOUBLE ADHESIVE TAPE

用途：背膠式，可快速拆卸，固定電線維修方便，不佔空間。

Part No.	A	B	C	H	Package
WLL-3	13.4	9.46	9.3	11.9	1000
WLL-21	9.3	5.5	6.6	9.0	
WLL-22	11.2	7.3	8.0	10.8	
WLL-23	15.0	11.1	9.2	12.0	

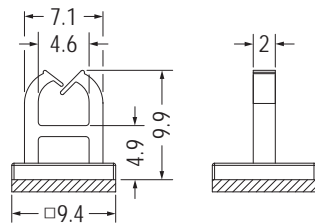
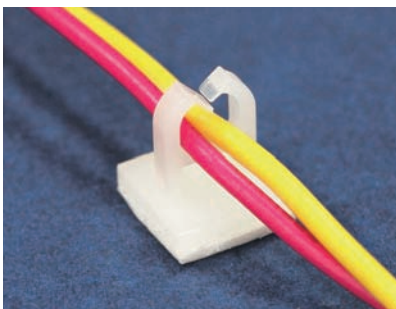

3M DOUBLE ADHESIVE TAPE

Part No.	Package
WLL-17	1000

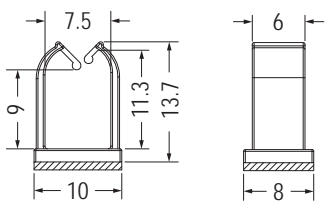

3M DOUBLE ADHESIVE TAPE

Part No.	Package
★WLL-36	1000

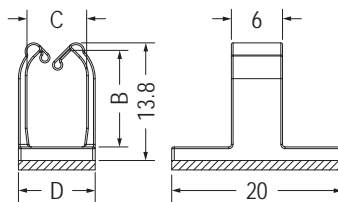

3M DOUBLE ADHESIVE TAPE

Part No.	B	C	D	Package
WLL-9	11.31	7.0	9.0	1000
WLL-18	11.18	6.0	8.0	

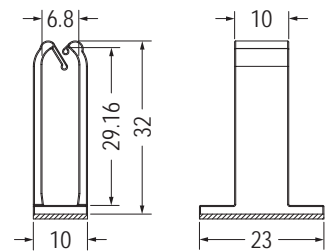

3M DOUBLE ADHESIVE TAPE

Part No.	Package
WLL-10	500

電線固定座 WIRE SADDLE

用途：背膠式，可快速拆卸，固定電線
維修方便，不佔空間。

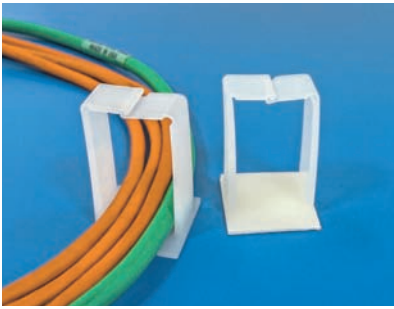

- Material: Nylon 66 (UL)
- Flame Class: 94V-2/94V-0
- Color: Natural/Black
- Unit: mm

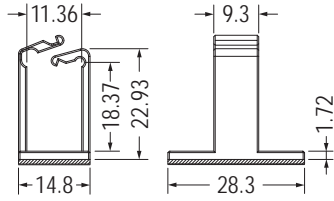

3M DOUBLE ADHESIVE TAPE

Part No.	Package
★WLU-6	500

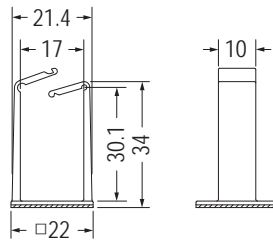

3M DOUBLE ADHESIVE TAPE

Part No.	Package
WLU-4	200

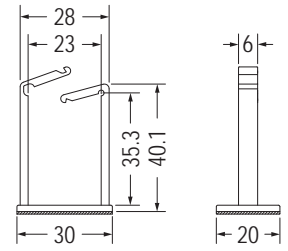

3M DOUBLE ADHESIVE TAPE

Part No.	Package
WLU-1	200

4

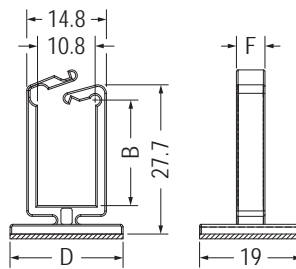

3M DOUBLE ADHESIVE TAPE

Part No.	B	D	F	Package
WLU-2	19.57	21.0	5.3	200
WLU-3	19.6	16.0	9.3	

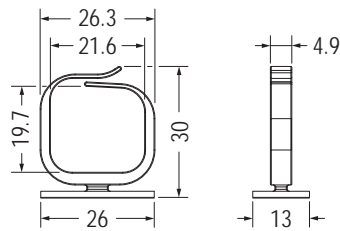

3M DOUBLE ADHESIVE TAPE

Part No.	Package
WLG-1	250

電線固定座 WIRE SADDLE

用途：超小型，背膠式，可快速固定及解開電線。



- Material: Nylon 66 (UL)
- Flame Class: 94V-2/94V-0
- Color: Natural/Black
- Unit: mm

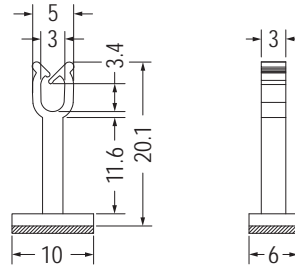

3M DOUBLE ADHESIVE TAPE THICKNESS 0.9

Part No.	Package
WLLD-14	1000

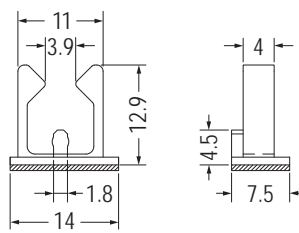
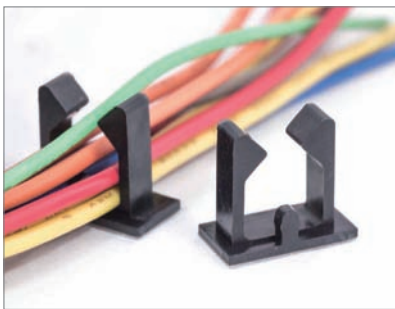

3M DOUBLE ADHESIVE TAPE

Part No.	Package
WLL-27	1000

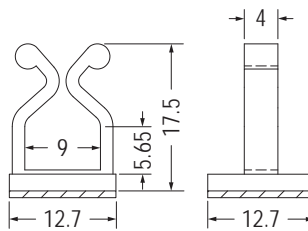

3M DOUBLE ADHESIVE TAPE

Part No.	Package
MWS-26	1000

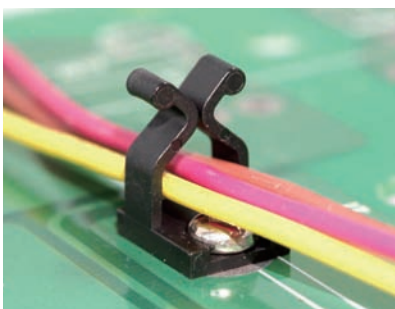

- Material: Nylon 66 (UL)
- Flame Class: 94V-2/94V-0
- Color: Natural/Black
- Unit: mm

用途：背膠式，亦可鎖螺絲，可快速拆卸，固定電線，維修方便，不佔空間。

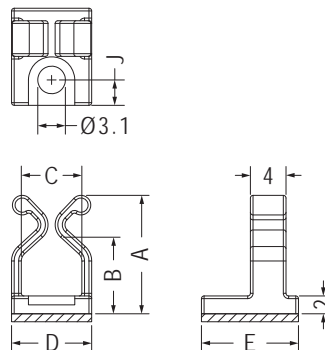

3M DOUBLE ADHESIVE TAPE

Part No.	A	B	C	D	E	J	Package
WLL-32	17.5	9.1	9.0	12.7	12.7	3.5	1000
WLL-33	13.3	6.6	6.8	9.0	10.9	2.85	

電線固定座 WIRE SADDLE

用途：背膠式，亦可鎖螺絲，可快速拆卸，固定電線，維修方便，不佔空間。

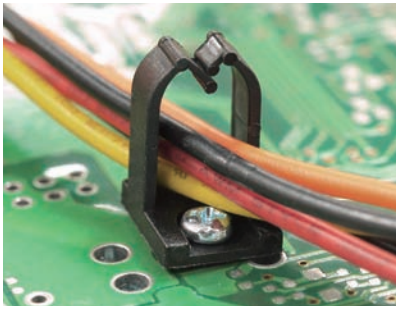

- Material: Nylon 66 (UL)
- Flame Class: 94V-2/94V-0
- Color: Natural/Black
- Unit: mm

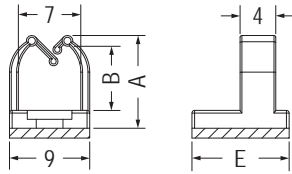
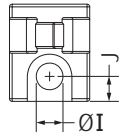

3M DOUBLE ADHESIVE TAPE

Part No.	A	B	E	I	J	Package
WLL-8	10.4	7.2	10.9	3.0	2.8	1000
WLL-11	14.0	10.8	10.9	2.7	2.85	
WLL-12	10.4	7.2	10.9	2.6	2.8	
WLL-26	14.0	9.8	11.0	2.7	2.9	
WLL-28	10.4	7.2	12.4	3.2	3.3	

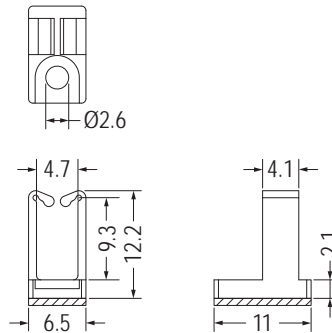

3M DOUBLE ADHESIVE TAPE

Part No.	Package
WLL-29	1000

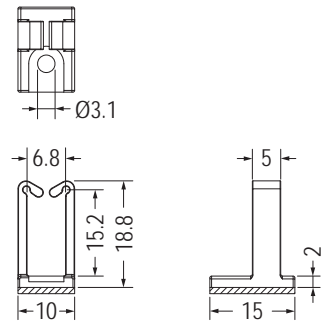

3M DOUBLE ADHESIVE TAPE

Part No.	Package
WLL-35	1000

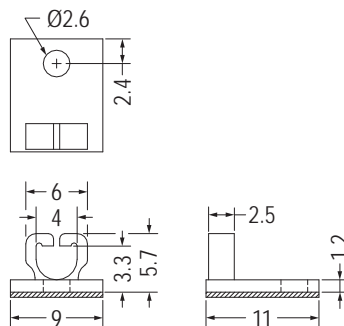

3M DOUBLE ADHESIVE TAPE

Part No.	Package
IMN-1	1000

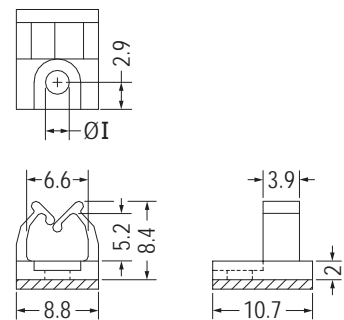
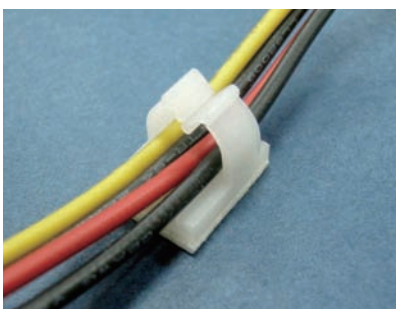

3M DOUBLE ADHESIVE TAPE

Part No.	I	Package
MWS-9	3.0	1000
MWS-9S	1.8	

電線固定座 WIRE SADDLE

用途：使用螺絲固定，可快速拆卸電線，維修方便，不易脫落。

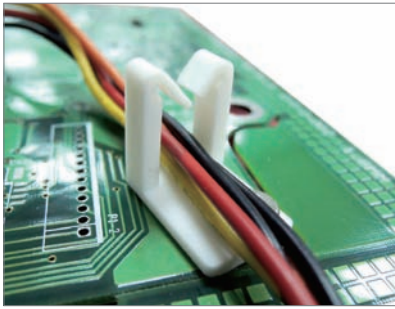

- Material: Nylon 66 (UL)
- Flame Class: 94V-2/94V-0
- Color: Natural/Black
- Unit: mm

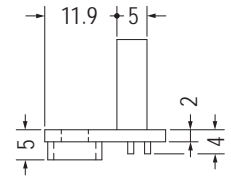
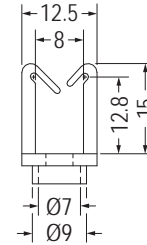
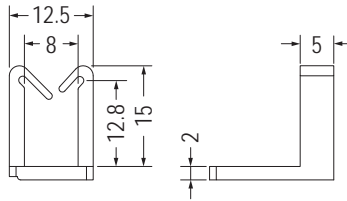
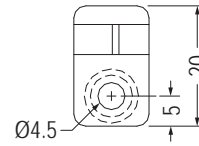
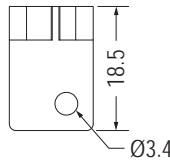

Part No.	Package
CHUB-1	1000

Part No.	Package
CHU-1	100

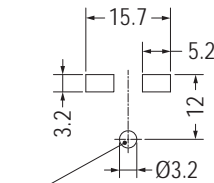
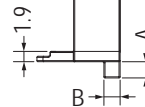
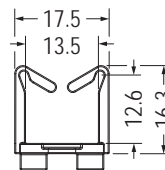
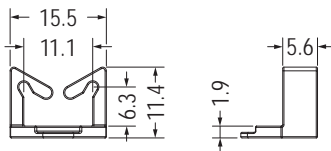
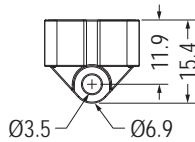
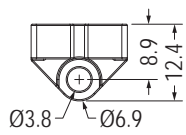
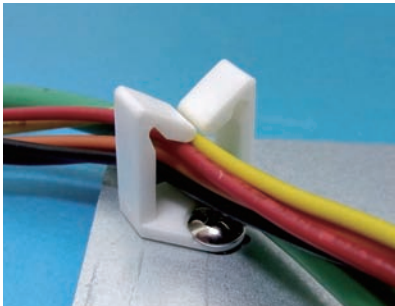

The dimension of mounting hole would depend on customer's screw spec.
孔大小照客戶螺絲增減

MOUNTING HOLE

【CHUA-2】

Part No.	A	B	Package
CHUA-1	/	/	1000
CHUA-2	3.0	3.0	

Part No.	Package
CHUF-1	1000

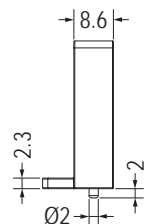
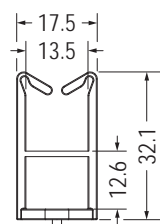
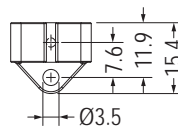
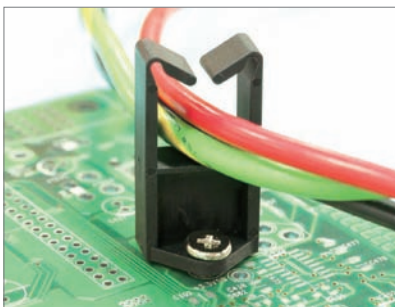

Part No.	Package
CHUC-1	1000

電線固定座 WIRE SADDLE

用途：使用螺絲固定，可快速拆卸電線，維修方便，不易脫落。



- Material: Nylon 66 (UL)
- Flame Class: 94V-2/94V-0
- Color: Natural/Black
- Unit: mm

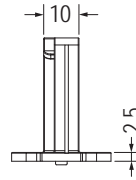
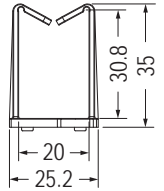
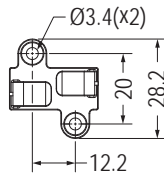

Part No.	Package
CHUL-1	500

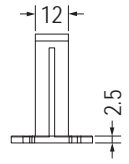
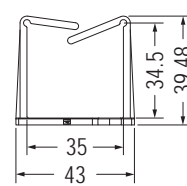
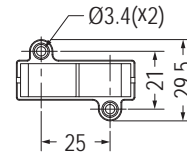

Part No.	Package
CHUL-2	100

4

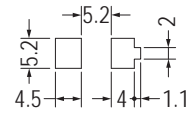
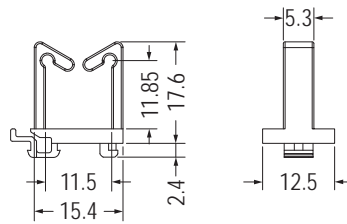

RECOMMEND MOUNTING HOLE THICKNESS 1.0

Part No.	Package
CHWG-1	1000

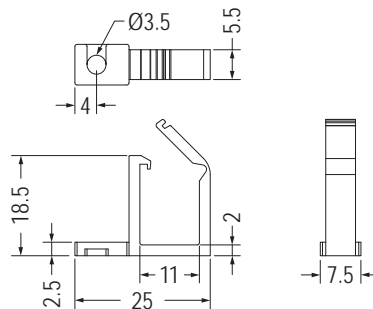
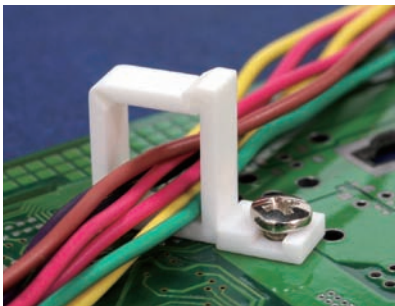

Part No.	Package
CHUE-1	1000

電線固定扣 CABLE CLAMP

用途：配合螺絲，固定電線，整齊美觀。

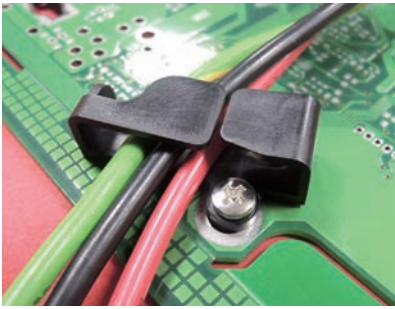

- Material: Nylon 66 (UL)
- Flame Class: 94V-2/94V-0
- Color: Natural/Black
- Unit: mm

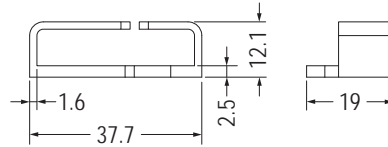
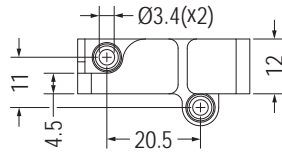

Part No.	Package
CCE-1	1000

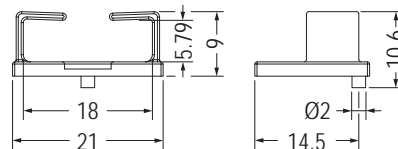
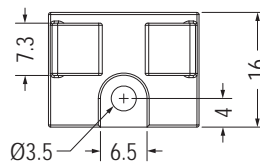
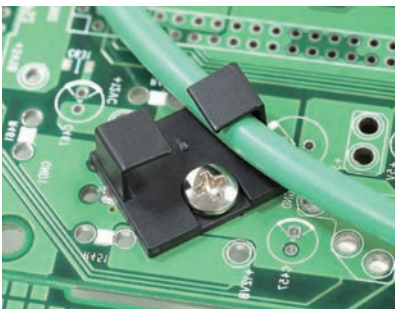

Part No.	Package
WT-11	1000

電線固定座 WIRE SADDLE

用途：背膠式，可快速拆卸，固定電線維修方便，不佔空間。



- Material: Nylon 66 (UL)
- Flame Class: 94V-2/94V-0
- Color: Natural/Black
- Unit: mm

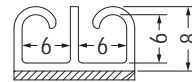
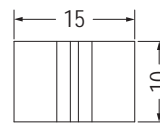

3M DOUBLE ADHESIVE TAPE

Part No.	Package
WLLT-1	1000

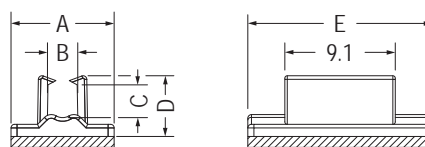
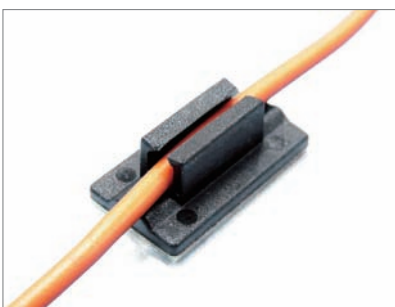

3M DOUBLE ADHESIVE TAPE

Part No.	A	B	C	D	E	Package
WTC-2	8.5	2.5	2.7	5.0	15.2	500
WTC-3	9.0	3.6	4.0	6.5	16.0	

電線固定座 WIRE MOUNT

用途：背膠式，可快速拆卸，固定電線維修方便，不佔空間。



- Material: ABS
- Color: Black
- Unit: mm

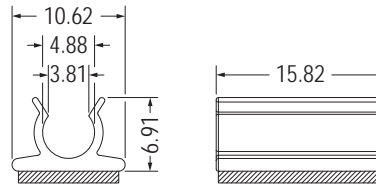

3M DOUBLE ADHESIVE TAPE

Part No.	Package
THVC-1	500

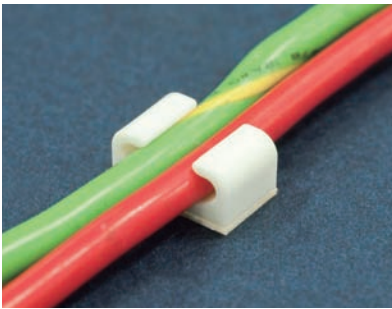

- Material: Nylon 66 (UL)
- Flame Class: 94V-2/94V-0
- Color: Natural/Black
- Unit: mm

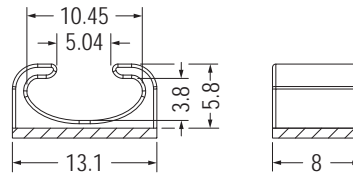

3M DOUBLE ADHESIVE TAPE

Part No.	Package
WLLT-3	1000

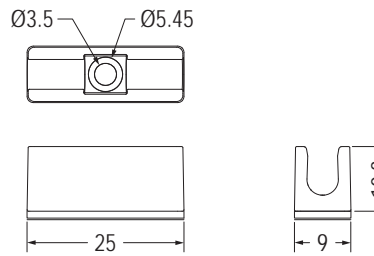
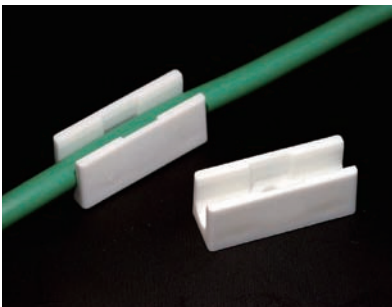

3M DOUBLE ADHESIVE TAPE

Part No.	Package
WLLT-6	1000

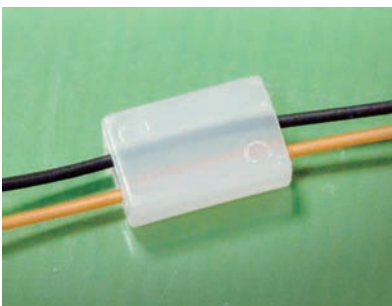

- Material: Nylon 66 (UL)
- Flame Class: 94V-2/94V-0
- Color: Natural/Black
- Unit: mm

用途：背膠式，用於電子、電腦內部電線固定，裝配容易，美觀不脫落。

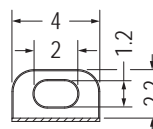
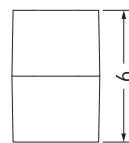

3M DOUBLE ADHESIVE TAPE

Part No.	Package
MWA-1	1000

電線固定座 CABLE CLAMP

用途：背膠式，可快速拆卸，固定電線維修方便，不佔空間。



- Material: Nylon 66 (UL)
- Flame Class: 94V-2/94V-0
- Color: Natural/Black
- Unit: mm

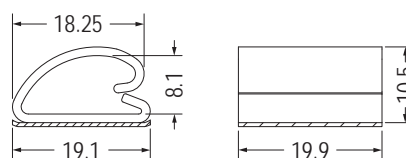

3M DOUBLE ADHESIVE TAPE

Part No.	Package
WUD-1	1000

電線固定座 MOUNT

用途：固定電線於機板上，維修方便，不佔空間。

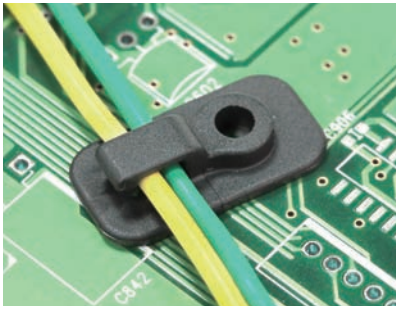

- Material: Nylon 66 (UL)
- Flame Class: 94V-2/94V-0
- Color: Natural/Black
- Unit: mm

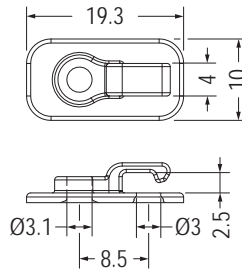

Part No.	Package
MIB-21	1000

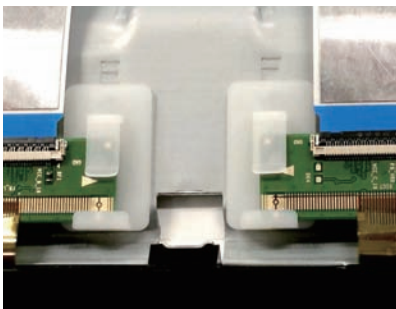

- Material: Nylon 66 (UL)
- Flame Class: 94V-2/94V-0
- Color: Natural/Black
- Unit: mm

用途：背膠式，可快速拆卸，固定電線維修方便，不佔空間。

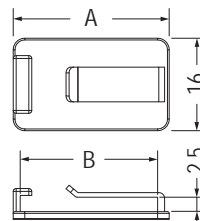

3M DOUBLE ADHESIVE TAPE

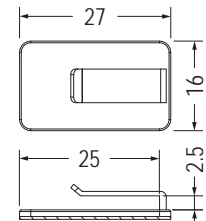

DOUBLE ADHESIVE TAPE

Part No.	A	B	Package
MIB-9	27.0	23.8	1000
MIB-17	31.9	28.7	

Part No.	Package
MIB-10	1000

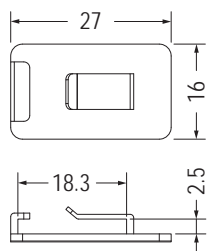

3M DOUBLE ADHESIVE TAPE

Part No.	Package
MIB-11	1000

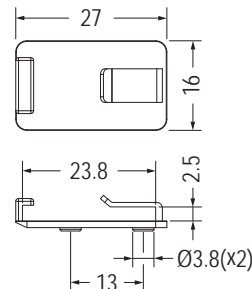

3M DOUBLE ADHESIVE TAPE

Part No.	Package
MIB-33	1000

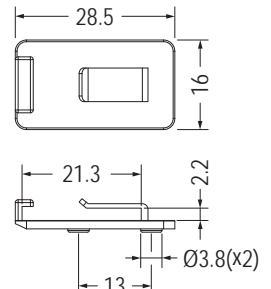

3M DOUBLE ADHESIVE TAPE

Part No.	Package
MIB-34	1000

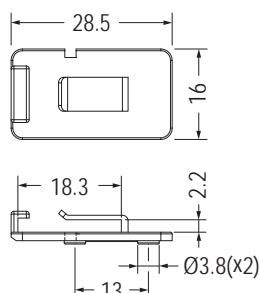

3M DOUBLE ADHESIVE TAPE

Part No.	Package
MIB-35	1000

電線固定座 MOUNT

用途：固定電線於機板上，維修方便，不佔空間。

- Material: Nylon 66 (UL)
- Flame Class: 94V-2/94V-0
- Color: Natural/Black
- Unit: mm

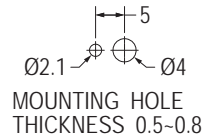
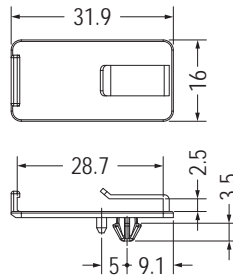
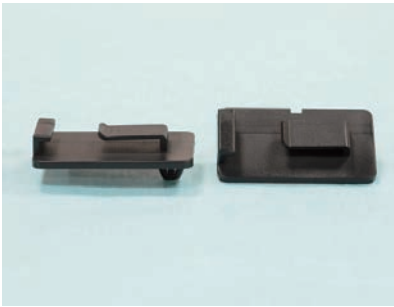

Part No.	Package
MIB-15	1000

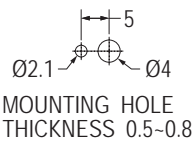
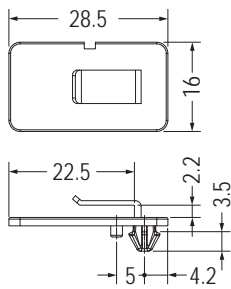

Part No.	Package
MIB-27	1000

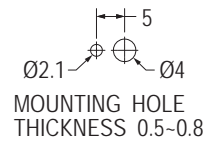
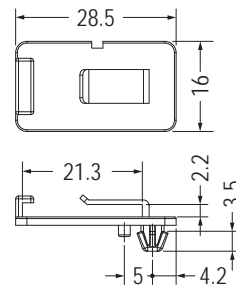

Part No.	Package
MIB-16	1000
MIB-31	

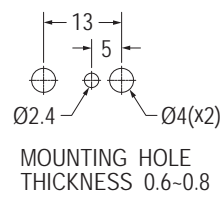
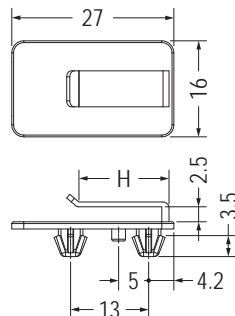

Part No.	H	Package
MIB-3	15.0	1000
MIB-14	8.0	

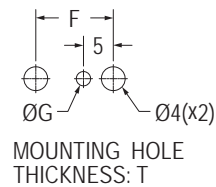
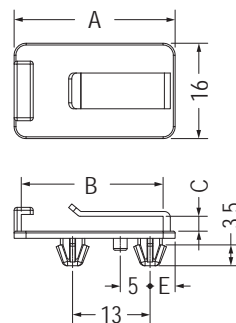

Part No.	A	B	C	E	F	G	T	Package
MIB-1	27.0	23.8	2.5	4.2	13.0	2.4	0.6~0.8	1000
MIB-4	31.9	28.7	2.5	9.1	13.0	2.1	0.5~0.8	
MIB-5	46.2	43.0	2.5	23.4	13.0	2.1	0.5~0.8	500
MIB-7	22.5	19.8	1.5	4.2	12.0	2.1	0.5	1000
MIB-8	28.5	25.25	2.55	4.2	13.0	2.4	0.5	
MIB-12	31.9	28.7	1.7	9.1	13.0	2.1	0.5~0.8	
MIB-13	31.9	28.7	1.4	9.1	13.0	2.1	0.5~0.8	
MIB-25	27.0	23.8	2.5	4.2	13.0	2.2	0.6~0.8	

電線固定座 MOUNT

用途：固定電線於機板上，維修方便，不佔空間。

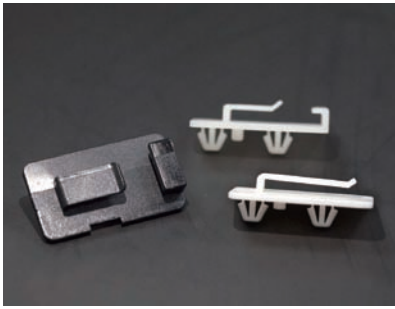

- Material: Nylon 66 (UL)
- Flame Class: 94V-2/94V-0
- Color: Natural/Black
- Unit: mm

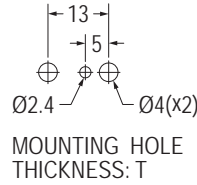
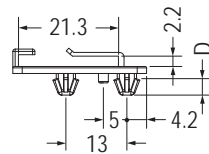
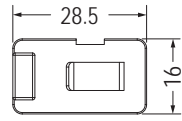

Part No.	D	T	Package
MIB-6	3.5	0.6-0.8	1000
MIB-24	2.7	1.0	
MIB-26	3.5	0.6-0.8	

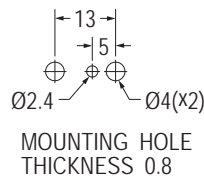
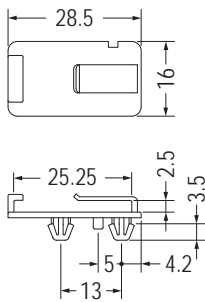

MOUNTING HOLE THICKNESS 0.8

Part No.	Package
MIB-22	1000

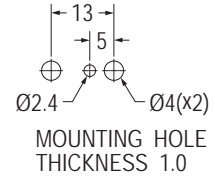
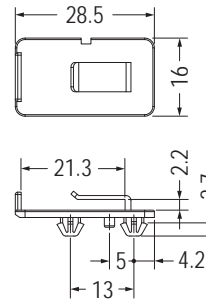

MOUNTING HOLE THICKNESS 1.0

Part No.	Package
MIB-23	1000

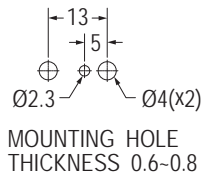
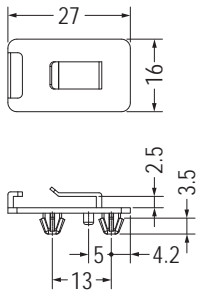

MOUNTING HOLE THICKNESS 0.6-0.8

Part No.	Package
MIB-2	1000

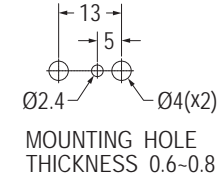
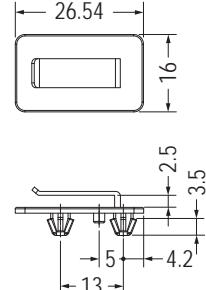

MOUNTING HOLE THICKNESS 0.6-0.8

Part No.	Package
MIB-28	1000

電線固定座 WIRE MOUNT

用途：背膠式，可快速拆卸，固定電線維修方便，不佔空間。

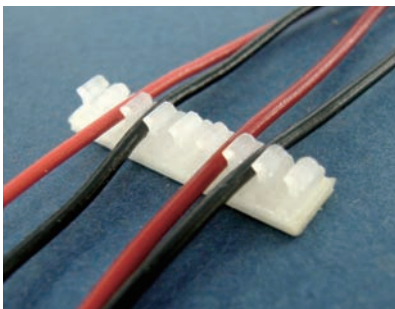

- Material: Nylon 66 (UL)
- Flame Class: 94V-2/94V-0
- Color: Natural/Black
- Unit: mm

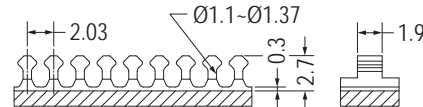
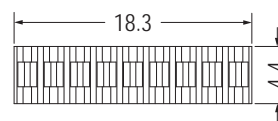

3M DOUBLE ADHESIVE TAPE

Part No.	Package
MU-01-8	500

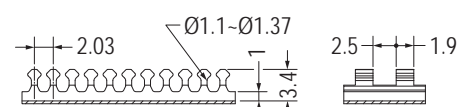
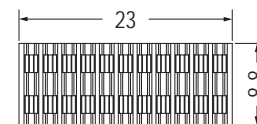

3M DOUBLE ADHESIVE TAPE

Part No.	Package
MU-02-10	200

電線固定座 WIRE MOUNT

用途：背膠式，可快速拆卸，固定電線維修方便，不佔空間。

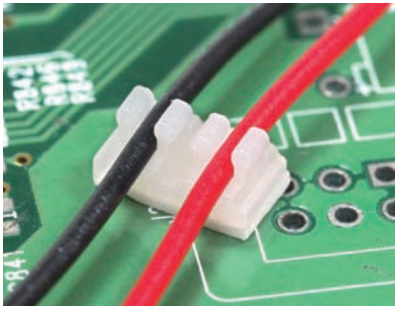

- Material: Nylon 66 (UL)
- Flame Class: 94V-2/94V-0
- Color: Natural/Black
- Unit: mm

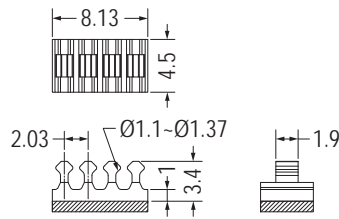

3M DOUBLE ADHESIVE TAPE

Part No.	Package
MU-03-3	500

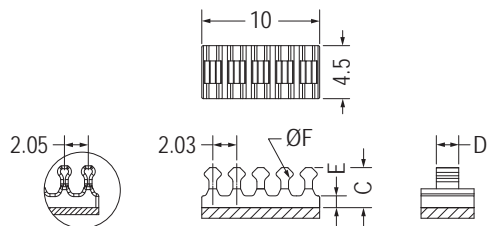

【 MU-03L-4 】 3M DOUBLE ADHESIVE TAPE

Part No.	C	D	E	F	Package
MU-03-4	3.4	1.9	1.0	1.1~1.37	500
MU-03L-4	3.6	2.0	1.2	1.4	

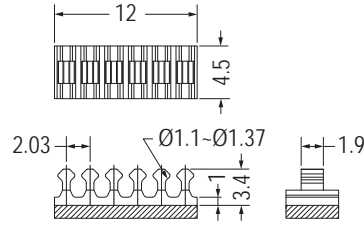

3M DOUBLE ADHESIVE TAPE

Part No.	Package
MU-03-5	500

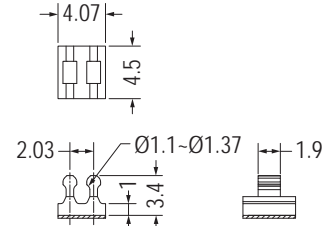

3M DOUBLE ADHESIVE TAPE

Part No.	Package
MU-05-1	500

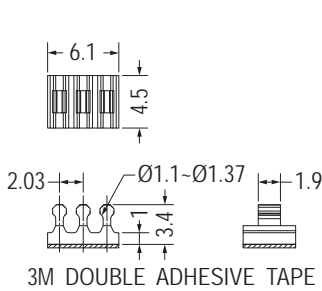

3M DOUBLE ADHESIVE TAPE

Part No.	Package
MU-05-2	500

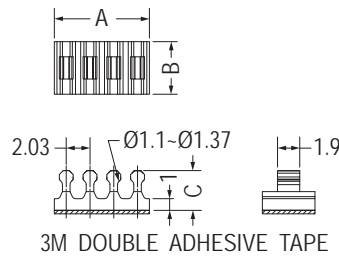

3M DOUBLE ADHESIVE TAPE

Part No.	A	B	C	Package
MU-05-3	8.13	4.5	3.4	500
MU-08-3	8.1	4.4	3.6	

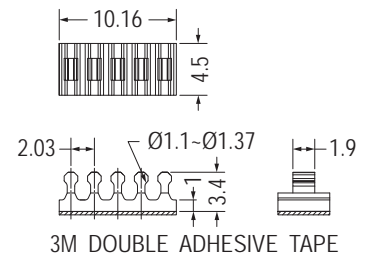

3M DOUBLE ADHESIVE TAPE

Part No.	Package
MU-05-4	500

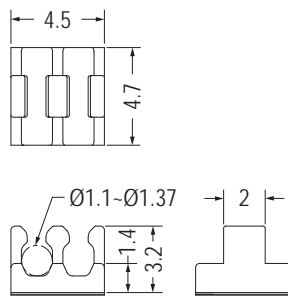

3M DOUBLE ADHESIVE TAPE

Part No.	Package
MU-07-2	1000

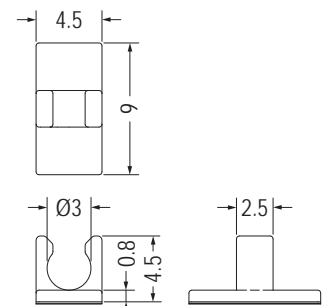

3M DOUBLE ADHESIVE TAPE

Part No.	Package
MUC-1	1000

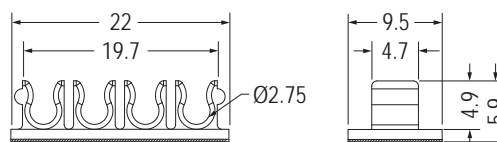

3M DOUBLE ADHESIVE TAPE

Part No.	Package
MUA-1	500

電線固定座 WIRE MOUNT



- Material: Nylon 66 (UL)
- Flame Class: 94V-2/94V-0
- Color: Natural/Black
- Unit: mm

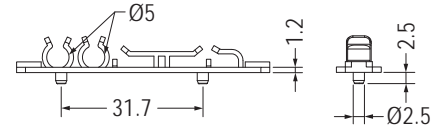
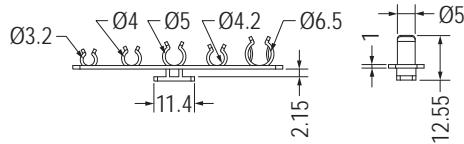
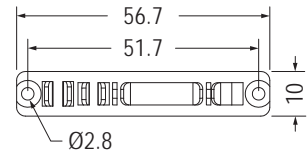
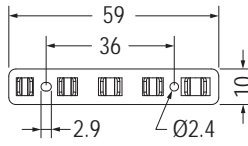

Part No.	Package
JETM-1	100

Part No.	Package
JETM-2	100

用途：固定電線於機板上，維修方便，不佔空間。

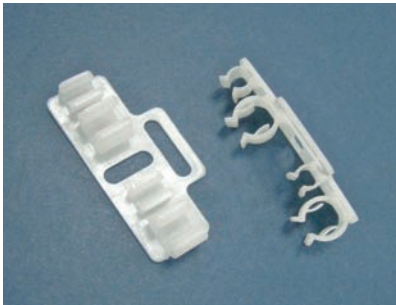

- Material: Nylon 66 (UL)
- Flame Class: 94V-2/94V-0
- Color: Natural/Black
- Unit: mm

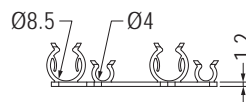
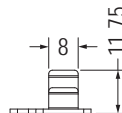
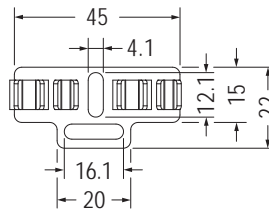

Part No.	Package
CMG-1	500

用途：快速拆卸，固定電線，維修方便，不佔空間。

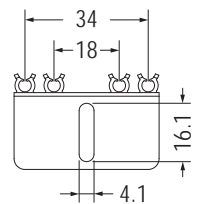
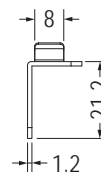
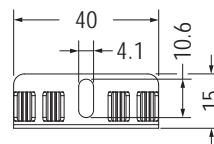

Part No.	Package
CMG-2	500

插頭固定座 MOUNT

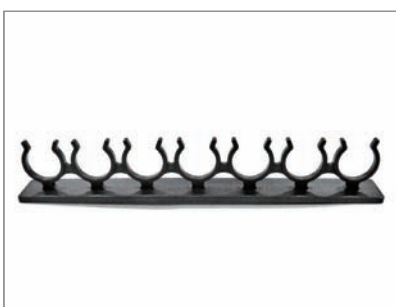

- Material: PP
- Color: Natural/Black
- Unit: mm

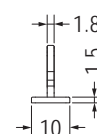
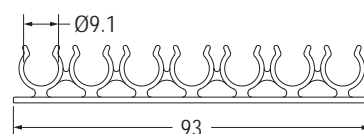

Part No.	Package
JETM-7	100

用途：可快速拆卸，固定插頭。

電線固定座 WIRE MOUNT

用途：固定電線於機殼上。

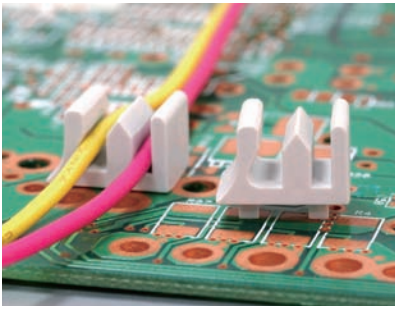

- Material: PC+ABS (UL)
- Flame Class: 94V-2/94V-0
- Color: Gray
- Unit: mm

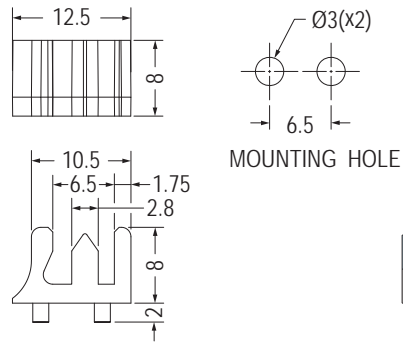

Part No.	Package
CFMG-1	1000

4

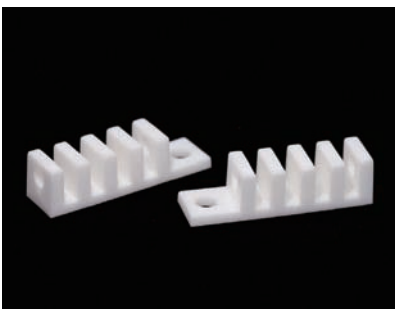

- Material: Nylon 66 (UL)
- Flame Class: 94V-2/94V-0
- Color: Natural/Black
- Unit: mm

用途：固定電線，整齊美觀。

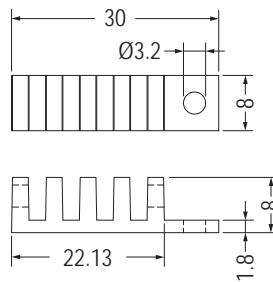

Part No.	Package
AIM25071	1000

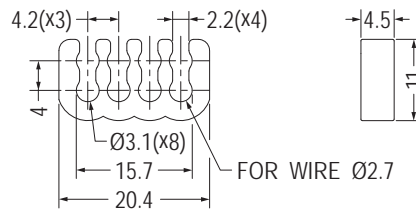

NEW

Part No.	Package
MUD-01-4	1000

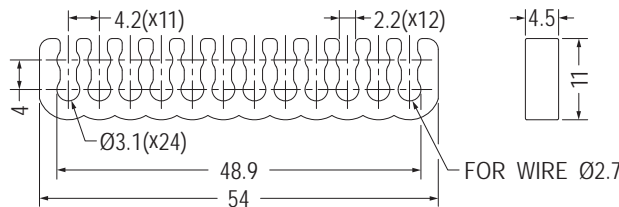

NEW

Part No.	Package
MUD-01-12	500

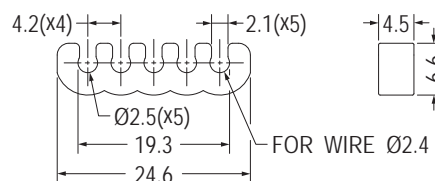

NEW

Part No.	Package
MUD-02-5	1000

電線固定座 WIRE MOUNT

用途：可將電線固定於機板上，電線不易磨損，配線整齊美觀。

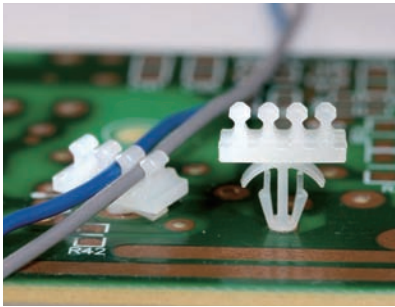

- Material: Nylon 66 (UL)
- Flame Class: 94V-2/94V-0
- Color: Natural/Black
- Unit: mm

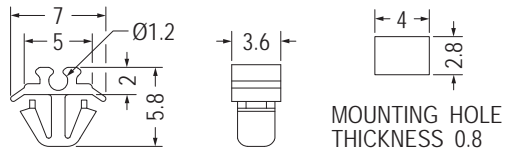

Part No.	Package
MUT-6	1000

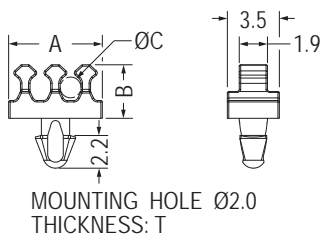

Part No.	A	B	C	T	Package
MUT-5	6.3	3.6	1.4	1.0	1000
MUT-5L	6.3	3.6	1.4	1.6	
MUT-13	7.3	3.9	1.8	1.7	

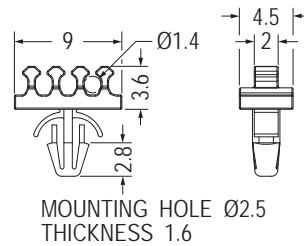

Part No.	Package
MUT-11	1000

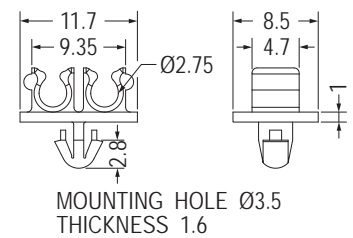

Part No.	Package
MUT-2	1000

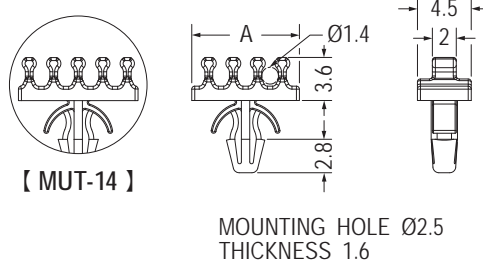
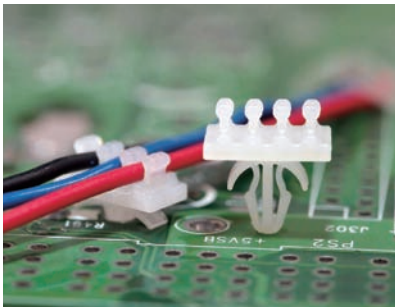

Part No.	A	Package
MUT-11-1	9.0	1000
MUT-14	10.0	

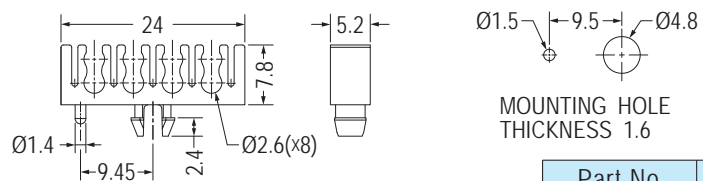
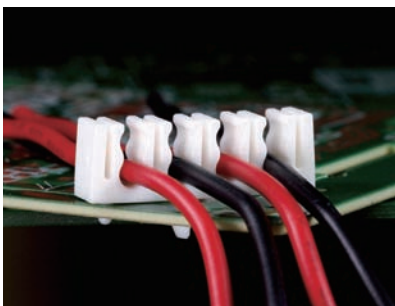

Part No.	Package
★MUT-15	1000

電線固定座 WIRE MOUNT

用途：可將電線固定於機板上，電線不易磨損，配線整齊美觀。

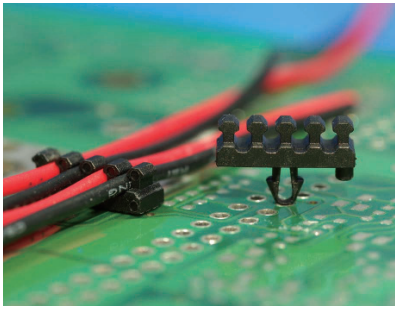

- Material: Nylon 66 (UL)
- Flame Class: 94V-2/94V-0
- Color: Natural/Black
- Unit: mm

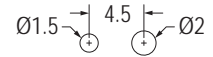
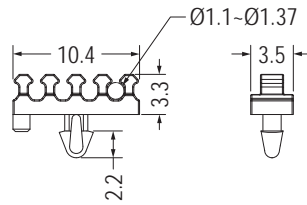

MOUNTING HOLE THICKNESS 1.2

Part No.	Package
MUT-10	1000

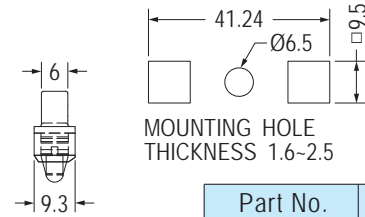
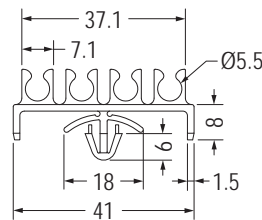
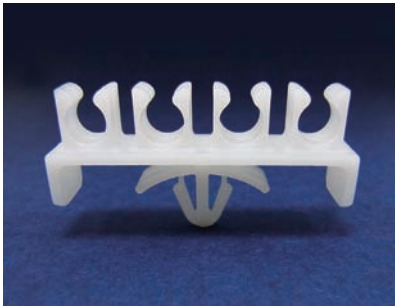

MOUNTING HOLE THICKNESS 1.6-2.5

Part No.	Package
MUT-3	500

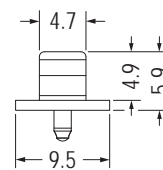
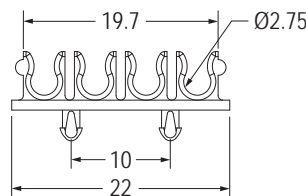
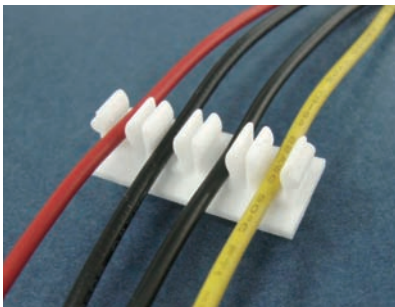

MOUNTING HOLE Ø1.75 THICKNESS 1.6

Part No.	Package
MUT-1	1000

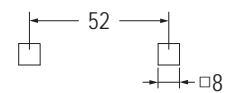
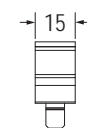
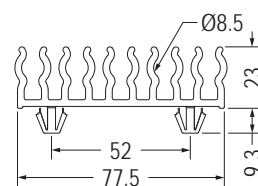

MOUNTING HOLE THICKNESS 1.5-2.0

Part No.	Package
MUT-4	200



- Material: POM
- Color: Natural
- Unit: mm

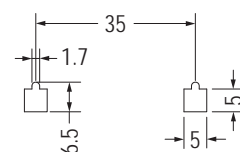
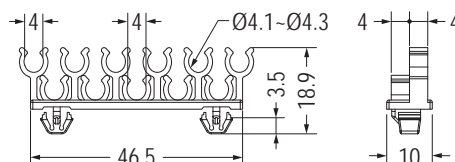

MOUNTING HOLE THICKNESS 1.0-1.5

Part No.	Package
MUT-8	500

天線束線座 WIRE HOLDER

用途：將天線固定於機殼上，電線不易磨損，配線整齊美觀。

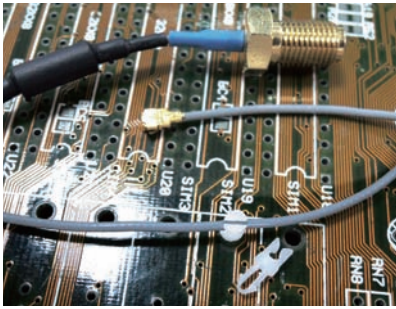

- Material: Nylon 66 (UL)
- Flame Class: 94V-2/94V-0
- Color: Natural/Black
- Unit: mm

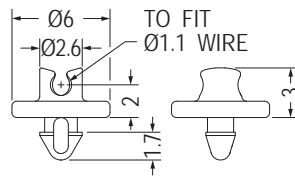

MOUNTING HOLE $\varnothing 2.0$
THICKNESS 0.8

Part No.	Package
★CHB-1	2000

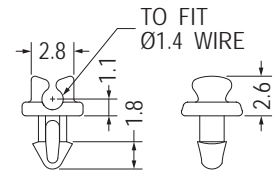

MOUNTING HOLE $\varnothing 2.0$
THICKNESS 1.6

Part No.	Package
CHBB-1.1	2000

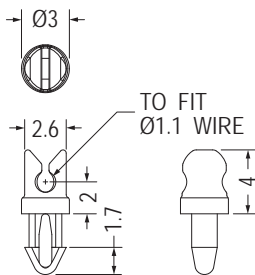

MOUNTING HOLE $\varnothing 2.0$
THICKNESS: T

Part No.	T	Package
CHBB-2	1.6~2.0	2000
CHBB-2-1	1.0~1.2	
CHBB-2-0.8	0.8	

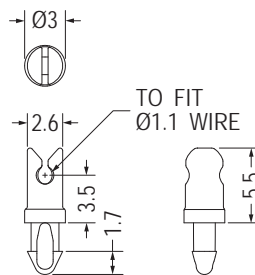

MOUNTING HOLE $\varnothing 2.0$
THICKNESS 1.6~2.0

Part No.	Package
CHBB-3.5	2000

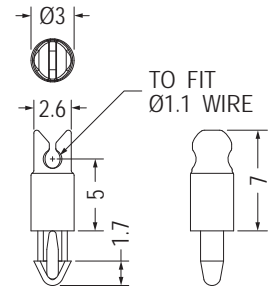

MOUNTING HOLE $\varnothing 2.0$
THICKNESS: T

Part No.	T	Package
CHBB-5	1.6~2.0	2000
CHBB-5-1	1.0~1.2	
CHBB-5-0.8	0.8	

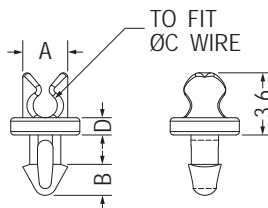

MOUNTING HOLE: $\varnothing 2.0$
THICKNESS: T

Part No.	A	B	C	D	G	T	Package
CHBB-1.6	2.8	1.7	1.4	0.9	1.8	1.2	2000
CHBB-1.7	2.6	1.8	1.37	1.0	2.0	1.6	

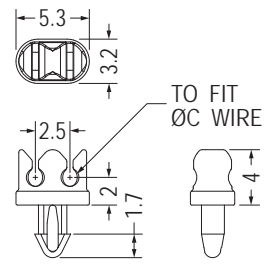

MOUNTING HOLE $\varnothing 2.0$
THICKNESS: T

Part No.	C	T	Package
CHBB2-2	1.1	1.6~2.0	2000
CHBB2-2-0.8	1.1	0.8	
CHBB2-2-1.2	1.37	1.2	

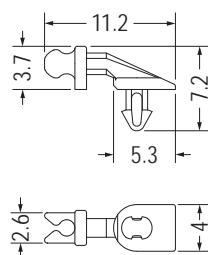

MOUNTING HOLE $\varnothing 2.0$
THICKNESS 1.6

Part No.	Package
CHBE-1	1000

天線固定座 ANTENNA MOUNT

用途：將天線固定於機殼上，電線不易磨損，配線整齊美觀。

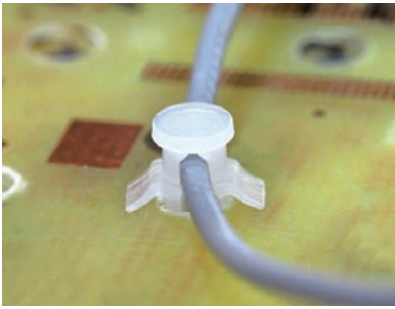

- Material: Nylon 66 (UL)
- Flame Class: 94V-2/94V-0
- Color: Natural/Black
- Unit: mm
- Patented (專利品)

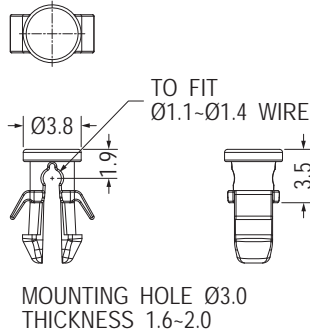

Part No.	Package
CHBD-1	1000

4



- Material: Nylon 66 (UL)
- Flame Class: 94V-2/94V-0
- Color: Natural/Black
- Unit: mm

用途：用於機頂盒或路由器WI-FI天線之固定。

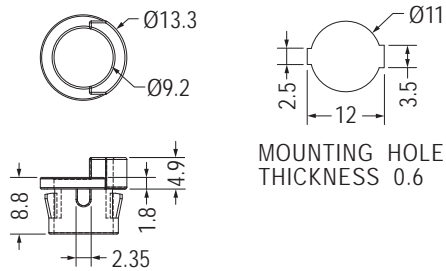

Part No.	Package
ANTCA-1	1000

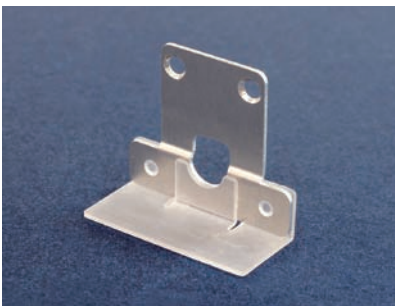

- Material: Nylon 66 (UL)
- Flame Class: 94V-2/94V-0
- Color: Natural/Black
- Unit: mm

用途：用於天線之固定與保護。

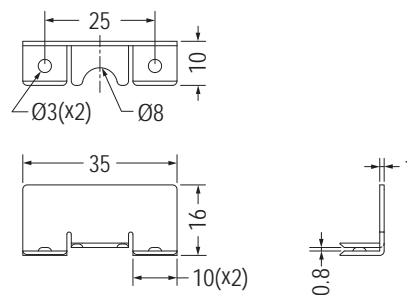

Part No.	Package
ANTCA-2	1000

WI-FI線固定座 WI-FI WIRE MOUNT

用途：用於WI-FI天線固定，避免脫落。

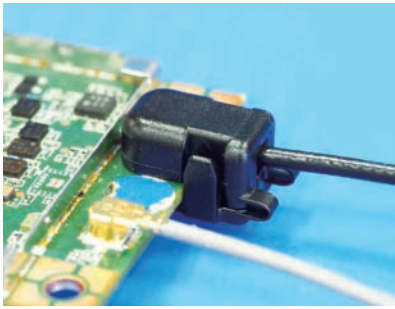

- Material: Nylon 66 (UL)
- Flame Class: 94V-2/94V-0
- Color: Black
- Unit: mm
- Patented (專利品)

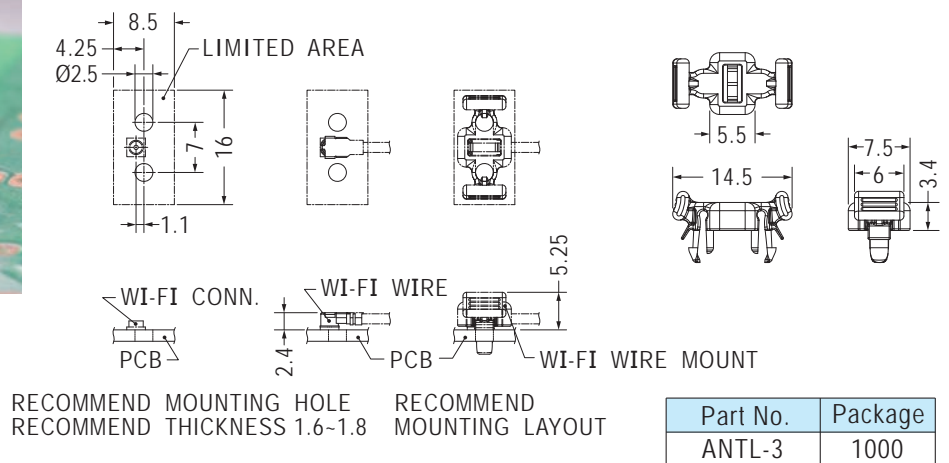
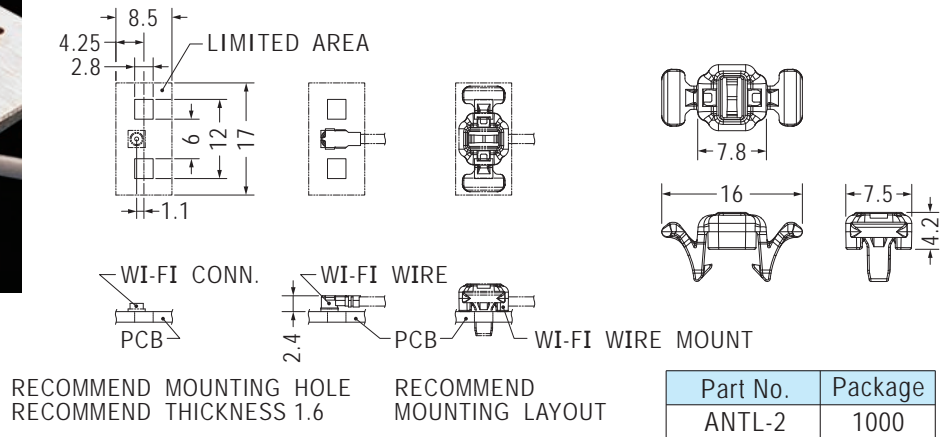
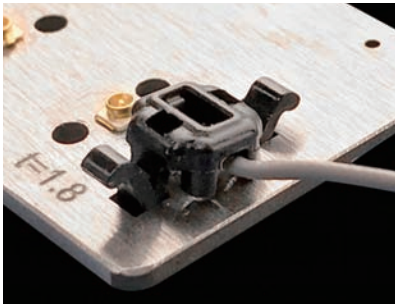
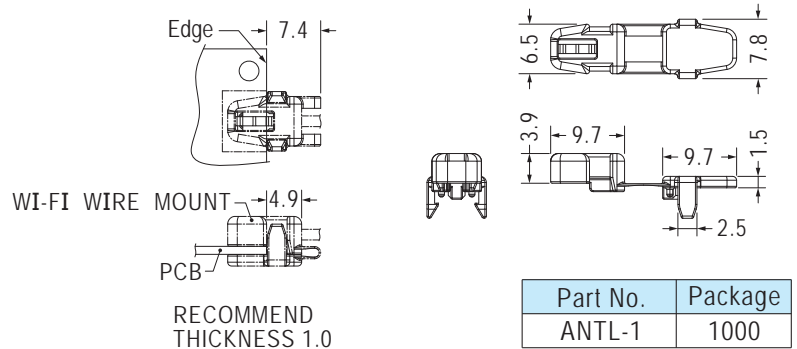

T8固定座 T8 MOUNT

用途：用於輕鋼架之固定網路天線。

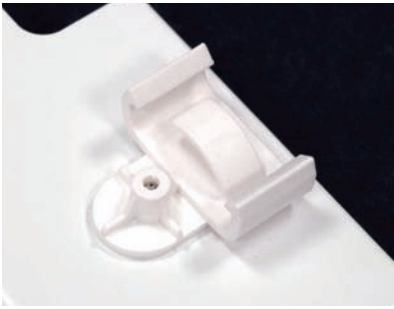

- Material: Nylon 66 (UL)
- Flame Class: 94V-2/94V-0
- Color: Natural/Black
- Unit: mm

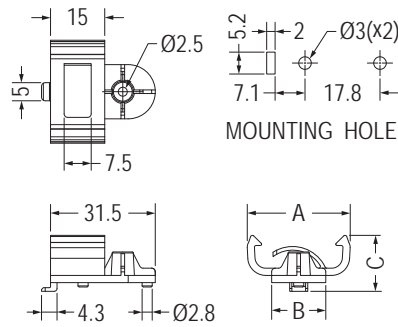

Part No.	A	B	C	Package
EM-550	18.3	8.0	14.1	500
EM-551	28.5	15.0	15.5	
EM-552	42.85	15.0	15.5	250

電線固定座 WIRE CLIP

用途：可背膠或螺絲固定，可快速拆卸電線，維修方便，不佔空間。

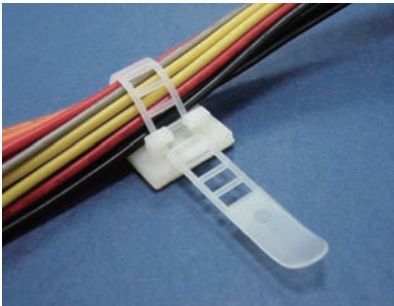

- Material: Nylon 66 (UL)
- Flame Class: 94V-2/94V-0
- Color: Natural/Black
- Unit: mm

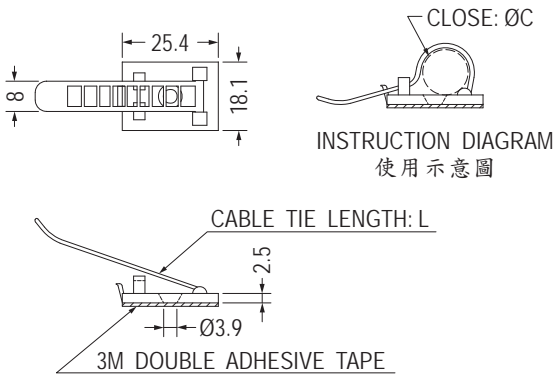

Part No.	C	L	Package
CL-1	14.0	64.2	200
CL-2	22.0	85.0	

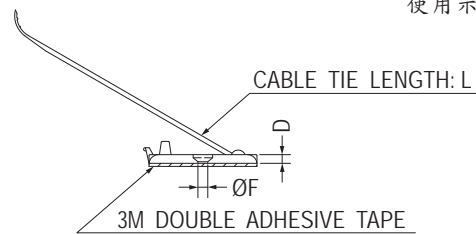
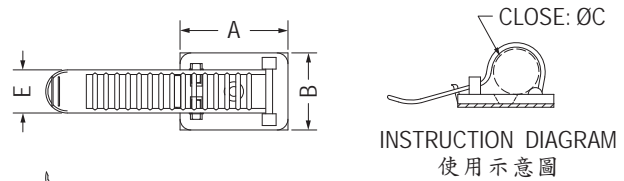

Part No.	A	B	C	D	E	F	L	Package
CL-3	35.0	25.0	22.0	2.8	14.0	3.2	88.3	100
CL-4	35.0	25.0	35.0	2.8	14.0	3.2	127.0	
CL-5	30.2	21.0	22.0	2.5	12.0	3.5	91.0	
CL-6	30.5	21.0	32.0	2.5	12.0	3.7	117.0	
CL-7	20.0	15.0	12.0	2.5	5.0	3.4	55.0	200
CL-13	25.4	18.0	7.0	2.5	8.0	3.9	35.0	

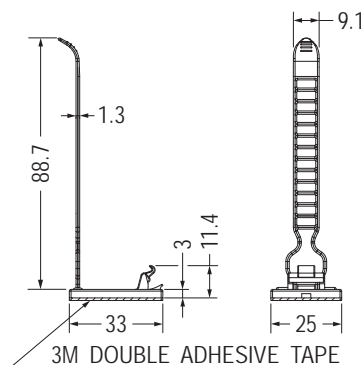

Part No.	Package
CLE-1	200

電線固定座 WIRE CLIP

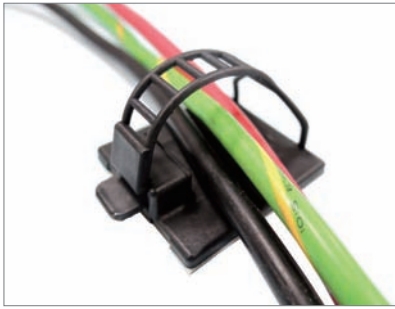

- Material: Nylon 66 (UL)
- Flame Class: 94V-2/94V-0
- Color: Natural/Black
- Unit: mm

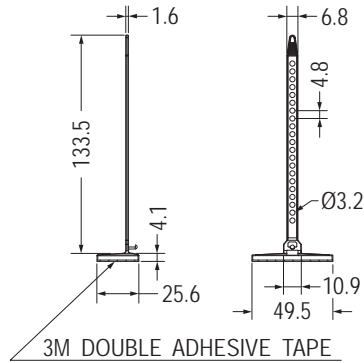

Part No.	Package
CLB-1	200

用途：背膠式，可快速拆卸，固定電線，維修方便，整齊美觀。

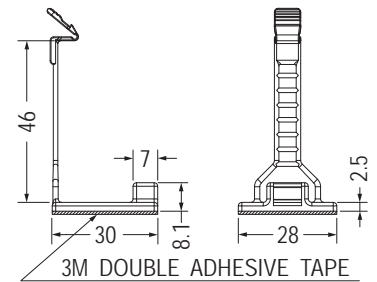

• Patented (專利品)

Part No.	Package
CLE-3	200



- Material: Nylon 66 (UL)
- Flame Class: 94V-2/94V-0
- Color: Natural/Black
- Unit: mm

用途：固定電線於機板上，維修方便，不佔空間。

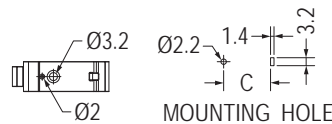
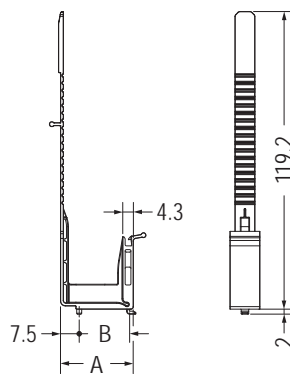

Part No.	A	B	C	Package
CLF-2	29.2	20.2	18.9	100
CLF-3	24.2	15.2	13.9	

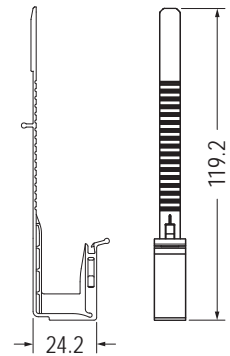

Part No.	Package
CLF-4	100



- Material: Nylon 66 (UL)
- Flame Class: 94V-2/94V-0
- Color: Natural/Black
- Unit: mm

用途：配合螺絲，固定電線，整齊美觀。

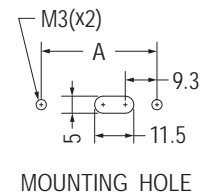
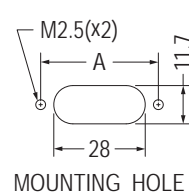
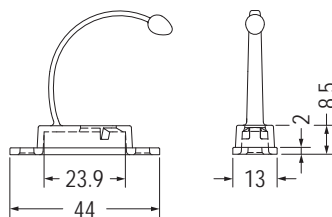

【CLG-2】

Part No.	A	Package
CLG-1	34.0	200
CLG-2	36.0	

電線固定座 WIRE SADDLE

用途：卡槽式，可快速捆紮及解開電線。

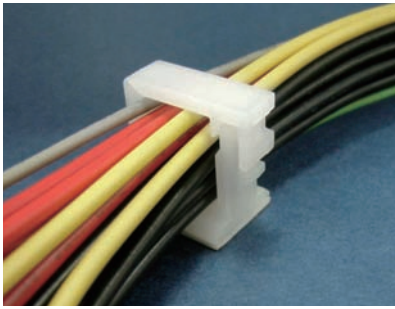

- Material: Nylon 66 (UL)
- Flame Class: 94V-2/94V-0
- Color: Natural/Black
- Unit: mm

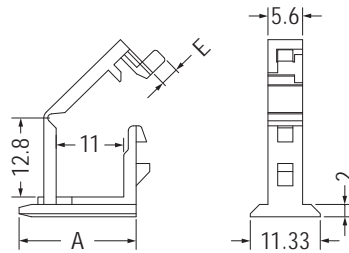

Part No.	A	E	Package
WLF-1	19.05	3.0	500
WLF-2	18.95		



【 WLF-5 】

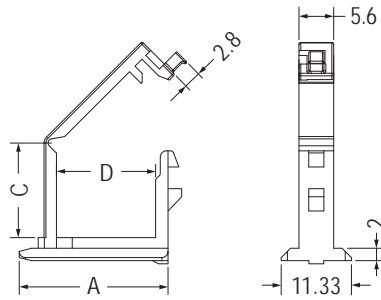

Part No.	A	C	D	Package
WLF-3	24.05	15.3	16.0	500
WLF-4	19.05	12.8	11.05	
WLF-5	19.05	12.8	11.05	

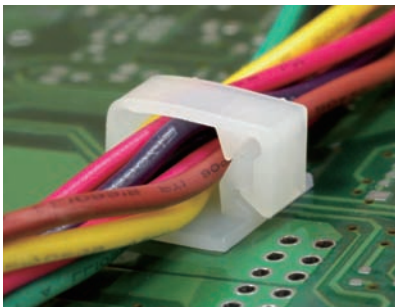

- Material: Nylon 66 (UL)
- Flame Class: 94V-2/94V-0
- Color: Natural/Black
- Unit: mm

用途：背膠式，可快速捆紮及解開電線。

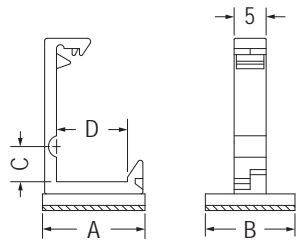

3M DOUBLE ADHESIVE TAPE

Part No.	A	B	C	D	Package
WLN-1S	16.0	14.0	5.5	11.1	500
WLN-6	13.0	12.0	6.0	8.1	

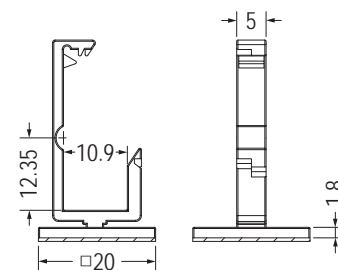
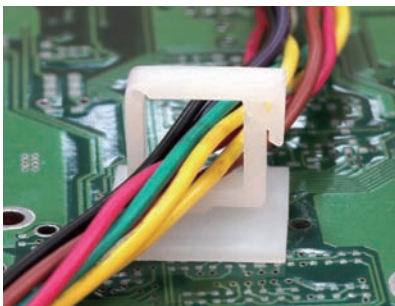

3M DOUBLE ADHESIVE TAPE

Part No.	Package
WLM-1	500

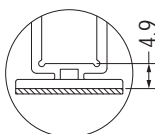

【 WLN-8 】

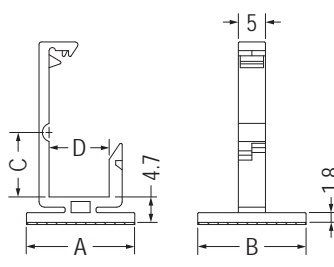

3M DOUBLE ADHESIVE TAPE

Part No.	A	B	C	D	Package
WLN-1	20.0	20.0	6.7	11.1	500
WLN-2	20.0	20.0	11.9	11.1	
WLN-3	20.0	20.0	15.7	15.7	250
WLN-5	15.0	14.0	8.7	10.75	500
WLN-7	16.0	12.0	8.7	10.75	
WLN-8	21.0	19.0	20.8	10.8	

電線固定座 WIRE SADDLE

用途：可用背膠式或螺絲固定，可快速捆紮及解開電線。

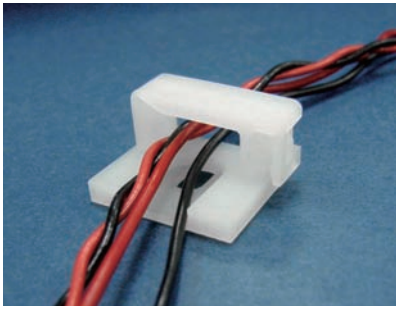

- Material: Nylon 66 (UL)
- Flame Class: 94V-2/94V-0
- Color: Natural/Black
- Unit: mm

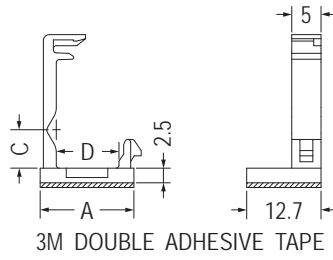

Part No.	A	C	D	Package
WLT-1	16.0	6.5	10.7	500
WLT-2	21.6	11.7	16.3	

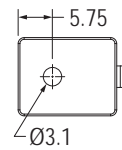
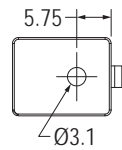
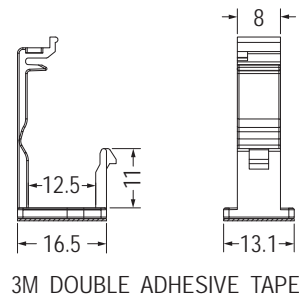
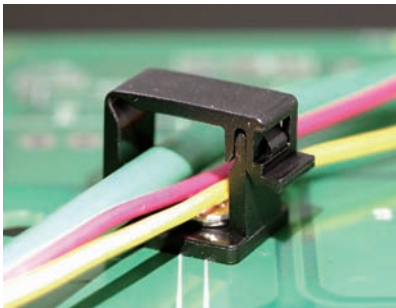

【 WLB-2 】

Part No.	Package
WLB-1	500
★WLB-2	



- Material: Nylon 66 (UL)
- Flame Class: 94V-2/94V-0
- Color: Natural/Black
- Unit: mm

用途：背膠式，可快速捆紮及解開電線。

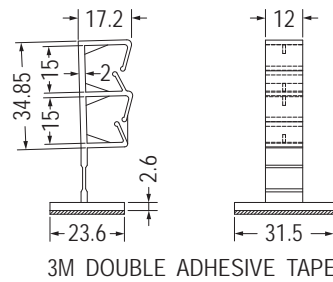

Part No.	Package
W2LK-1	50

電線固定座 WIRE SADDLE

用途：固定電線於PC板或機板上，維修方便，不佔空間。

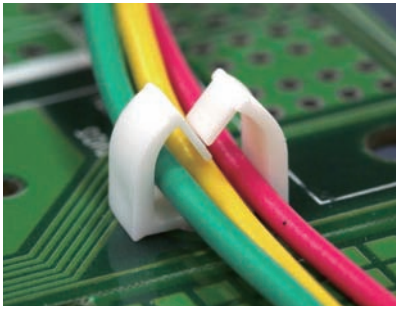

- Material: Nylon 66 (UL)
- Flame Class: 94V-2/94V-0
- Color: Natural/Black
- Unit: mm

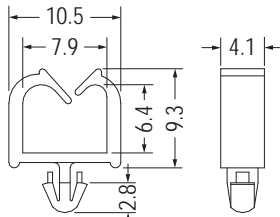

MOUNTING HOLE Ø3.0
THICKNESS 0.8-1.6

Part No.	Package
MWS-12	1000

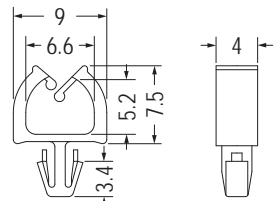

MOUNTING HOLE Ø3.0
THICKNESS 1.6

Part No.	Package
MWS-10	1000

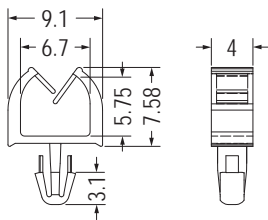

MOUNTING HOLE Ø3.0
THICKNESS 2.4

Part No.	Package
MWS-53	1000

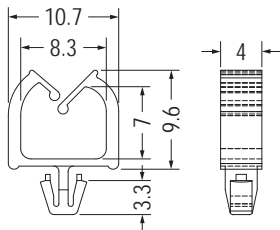

MOUNTING HOLE Ø3.3
THICKNESS 1.0

Part No.	Package
MWS-31	1000

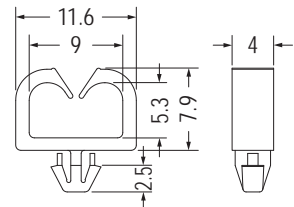

MOUNTING HOLE Ø3.5
THICKNESS 0.8-1.2

Part No.	Package
MWS-19	1000

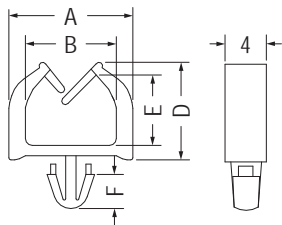

MOUNTING HOLE: ØG
THICKNESS 1.0-1.6

Part No.	A	B	D	E	F	G	Package	UL
MWS-6	12.0	8.8	11.0	8.5	2.8	3.5	1000	UL
MWS-7	9.2	6.8	7.6	5.0	2.7	3.0	2000	UL
MWS-41	12.0	9.0	11.5	8.48	2.8	3.5	1000	

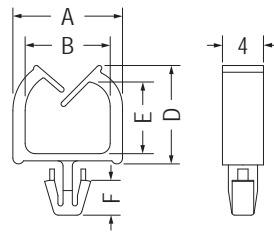

MOUNTING HOLE: ØG
THICKNESS: T

Part No.	A	B	D	E	F	G	T	Package
MWS-11	9.0	6.6	7.65	5.15	3.2	3.5	1.6	1000
MWS-11S	9.0	6.6	7.65	5.15	2.8	3.5	1.0	
MWS-15	10.7	8.3	9.6	7.0	3.4	3.0	1.6	
MWS-15S	10.7	8.3	9.6	7.0	2.4	3.0	1.6	

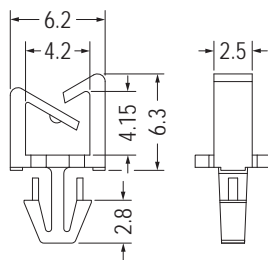
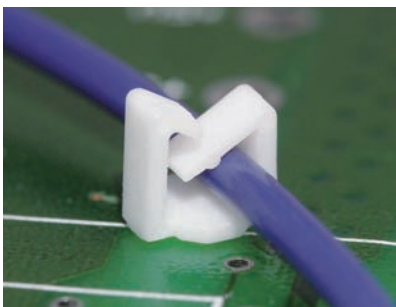

MOUNTING HOLE Ø3.0
THICKNESS 1.6

Part No.	Package
MWS-58	1000

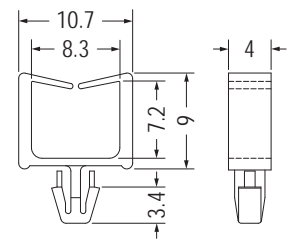

MOUNTING HOLE Ø3.0
THICKNESS 1.6

Part No.	Package
MWS-38	1000

電線固定座 WIRE SADDLE

用途：固定電線於PC板或機板上，維修方便，不佔空間。

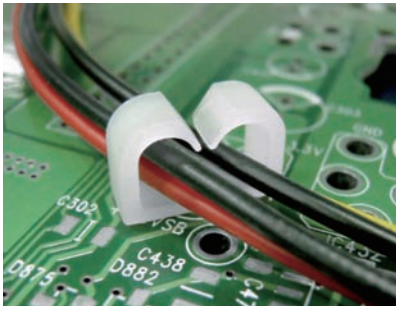

- Material: Nylon 66 (UL)
- Flame Class: 94V-2/94V-0
- Color: Natural/Black
- Unit: mm

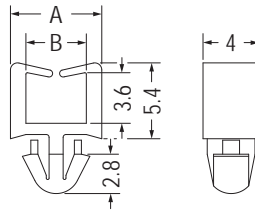

MOUNTING HOLE $\varnothing 3.5$
THICKNESS: T

Part No.	A	B	T	Package
MWS-13	6.5	4.3	1.0	1000
MWS-13L	7.8	5.6	1.5	
MWS-14	6.5	4.3	4.0	

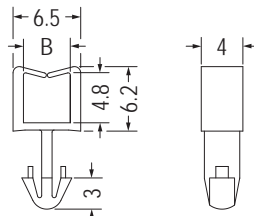

MOUNTING HOLE $\varnothing 3.5$
THICKNESS: T

Part No.	B	T	Package
MWS-20	4.5	4.0	1000
MWS-25	4.3	2.5	

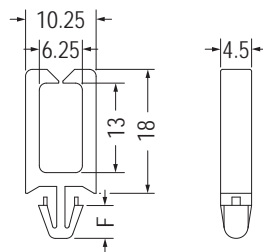
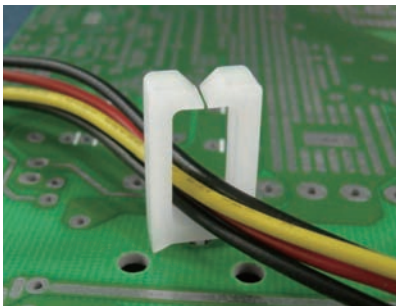

MOUNTING HOLE: $\varnothing G$
THICKNESS: T

Part No.	F	G	T	Package
CHY-1	4.8	4.8	1.8	1000
CHY-1S	2.5	3.0	1.6	

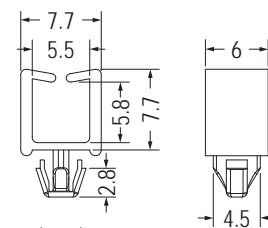

MOUNTING HOLE THICKNESS 1.0-1.2



Part No.	Package
MWS-60	1000

電線固定座 WIRE SADDLE

用途：固定電線於PC板或機板上，維修方便，不佔空間。

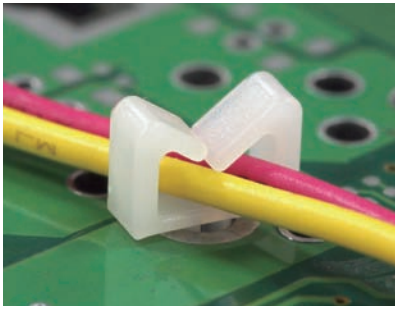

- Material: Nylon 66 (UL)
- Flame Class: 94V-2/94V-0
- Color: Natural/Black
- Unit: mm

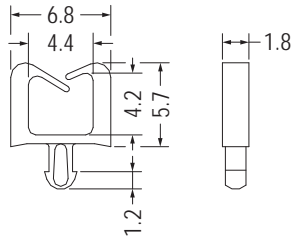

MOUNTING HOLE Ø1.75
THICKNESS 1.6

Part No.	Package
MWS-16	2000

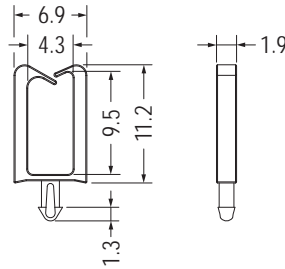

MOUNTING HOLE Ø1.75
THICKNESS 2.2

Part No.	Package
MWS-55	2000

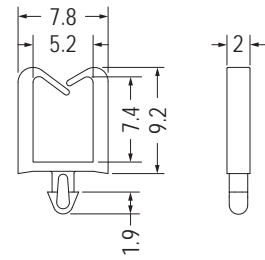

MOUNTING HOLE Ø2.0
THICKNESS: T

Part No.	T	Package
MWS-59	1.6	2000
MWS-59S	0.8	
MWS-59L	2.0	

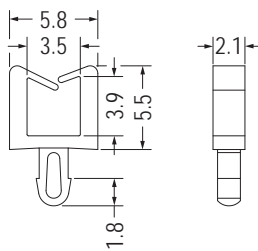

MOUNTING HOLE Ø2.0
THICKNESS: T

Part No.	T	Package
MWS-8	1.6~1.8	2000
MWS-8S	1.2	

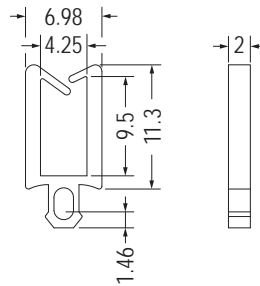

MOUNTING HOLE Ø2.8
THICKNESS 2.0

Part No.	Package
MWS-24	2000

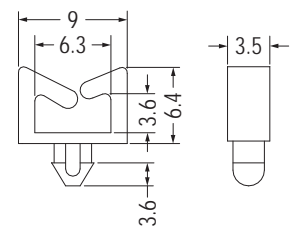

MOUNTING HOLE Ø3.0
THICKNESS 1.2-1.6

Part No.	Package
MWS-1	2000

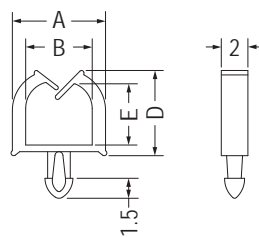

MOUNTING HOLE Ø1.75
THICKNESS 1.6

Part No.	A	B	D	E	Package
MWS-17	7.0	5.0	6.4	4.6	2000
MWS-44	8.5	6.5	7.0	5.2	

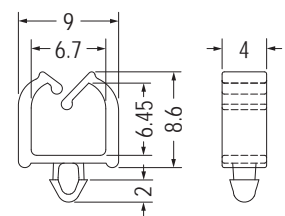

MOUNTING HOLE Ø3.0
THICKNESS 1.1

Part No.	Package
MWS-50	200

電線固定座 WIRE SADDLE

用途：固定電線於PC板或機板上，維修方便，不佔空間。



- Material: Nylon 66 (UL)
- Flame Class: 94V-2/94V-0
- Color: Natural/Black
- Unit: mm

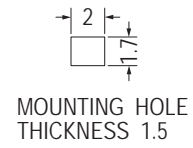
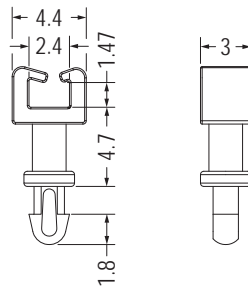

NEW

Part No.	Package
MWSD-2	1000

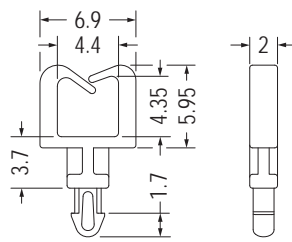
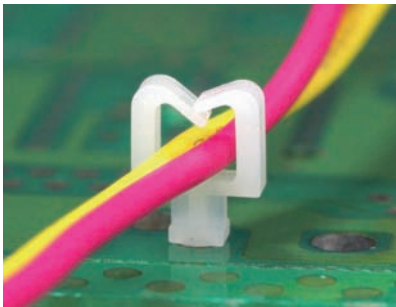

MOUNTING HOLE Ø2.0 THICKNESS 1.6

Part No.	Package
MWS-47	1000

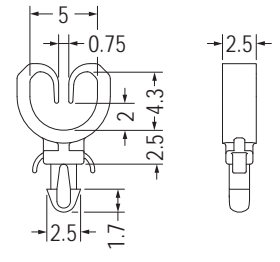

MOUNTING HOLE Ø2.0 THICKNESS 1.6

Part No.	Package
★MWS-63	2000

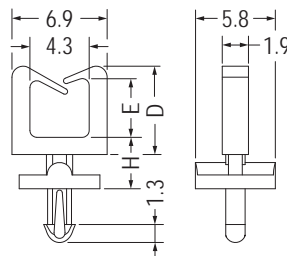
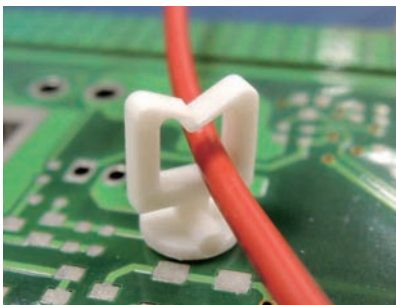

MOUNTING HOLE: ØG THICKNESS: T

Part No.	D	E	G	H	T	Package
MWSD-3	6.4	4.26	1.8-1.9	3.73	2.4	1000
MWSD-4	7.3	5.1	1.78	6.4	1.57	

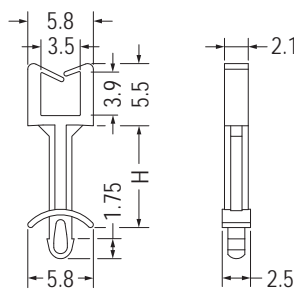
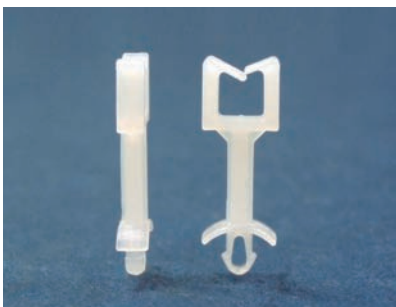

MOUNTING HOLE Ø2.0 THICKNESS 1.6-1.8

Part No.	H	Package
MWSE-1	9.0	1000
MWSE-2	7.0	
MWSE-4	15.0	

電線束線座 WIRE HOLDER



- Material: Nylon 66 (UL)
- Flame Class: 94V-2/94V-0
- Color: Natural/Black
- Unit: mm

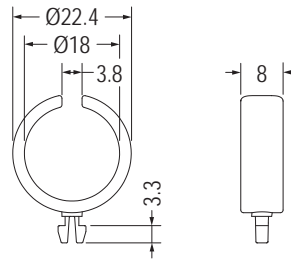

MOUNTING HOLE $\varnothing 4.0$
THICKNESS 2.5

用途：固定電線於機板上，維修方便，不佔空間。

Part No.	Package
THCC-1	500

電線固定座 WIRE SADDLE



- Material: Nylon 66 (UL)
- Flame Class: 94V-2/94V-0
- Color: Natural/Black
- Unit: mm

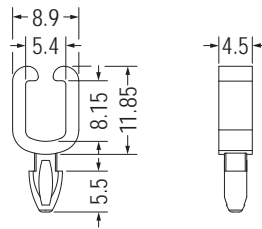

MOUNTING HOLE $\varnothing 4.0$
THICKNESS 2.2

用途：固定電線於PC板或機板上，維修方便，不佔空間。

Part No.	Package
MWS-28	2000

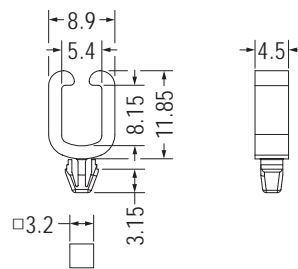

MOUNTING HOLE
THICKNESS 0.6-1.2

Part No.	Package
MWS-40	2000

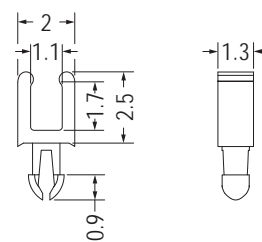
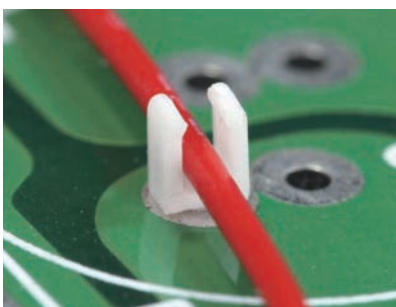

MOUNTING HOLE $\varnothing 1.0$
THICKNESS 1.0

Part No.	Package
MWSC-7	1000

電線固定座 WIRE SADDLE

用途：固定電線於PC板或機板上，維修方便，不佔空間。

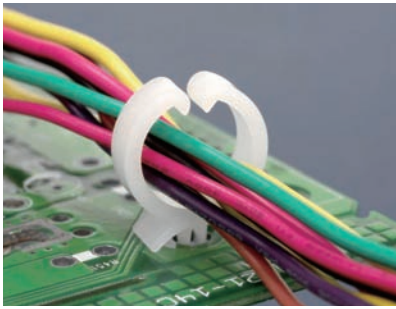

- Material: Nylon 6 (UL)
- Flame Class: 94V-2
- Color: Natural
- Unit: mm

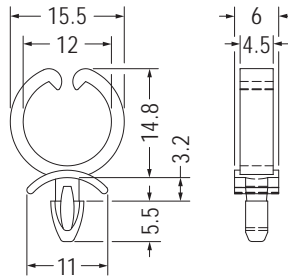

MOUNTING HOLE: ØG
THICKNESS 0.8-2.2

Part No.	G	Package
CHBA-1	3.5	1000
CHBA-2	3.2	

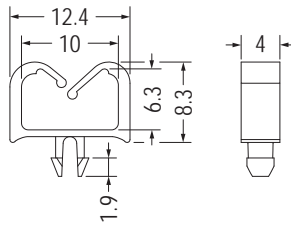

MOUNTING HOLE Ø3.0
THICKNESS: T

Part No.	T	Package
MWSC-2	1.5	1000
MWSC-2L	2.0	

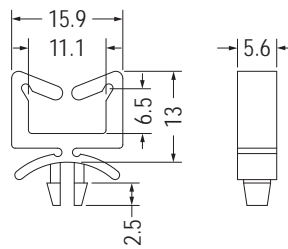
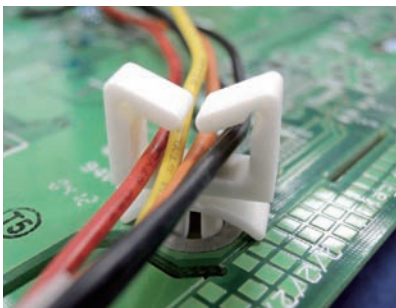

MOUNTING HOLE: ØG
THICKNESS 0.8-1.6

Part No.	G	Package
CHAE-1	4.8	1000
CHAE-1S	4.4	

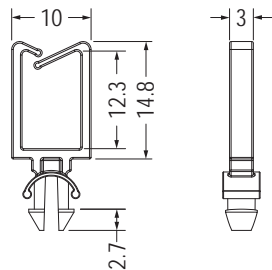

MOUNTING HOLE Ø4.4
THICKNESS 2.0-3.0

Part No.	Package
CHAV-1	1000

電線固定座 WIRE SADDLE

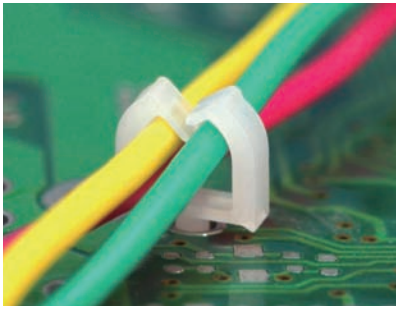

- Material: Nylon 66 (UL)
- Flame Class: 94V-2/94V-0
- Color: Natural/Black
- Unit: mm

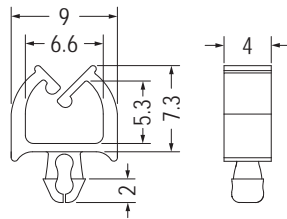

MOUNTING HOLE Ø3.0
THICKNESS 1.2~1.6

Part No.	Package
MWSC-1	1000

用途：固定電線於PC板或機板上，維修方便，不佔空間。

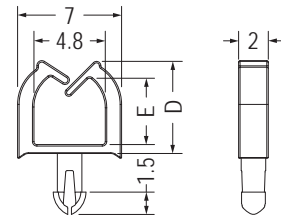

MOUNTING HOLE Ø1.7
THICKNESS: T

Part No.	D	E	T	Package
MWSC-3	6.3	4.46	2.4	1000
MWSC-4	4.0	2.2	2.4	
MWSC-5	4.0	2.2	1.6	
MWSC-6	6.0	4.2	1.6	

4

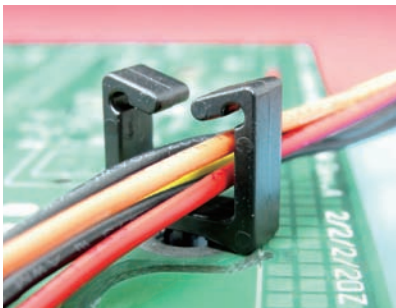

- Material: PC+ABS (UL)
- Flame Class: 94V-2/94V-0
- Color: Natural/Black
- Unit: mm

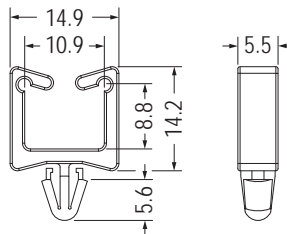

MOUNTING HOLE Ø4.8
THICKNESS 1.1

Part No.	Package
CHAW-1	1000

用途：固定電線於PC板或機板上，維修方便，不佔空間。

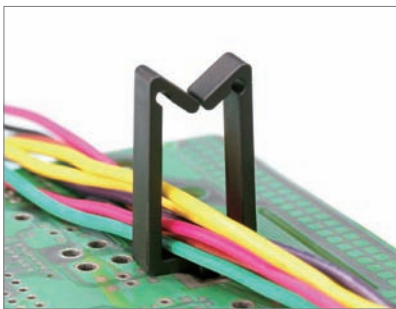

- Material: Nylon 66 (UL)
- Flame Class: 94V-2/94V-0
- Color: Natural/Black
- Unit: mm

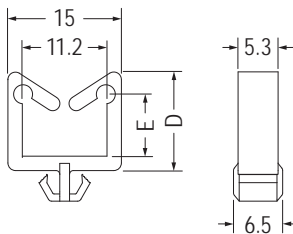

MOUNTING HOLE
THICKNESS 1.0

Part No.	D	E	Package
CHAB-1	12.0	7.2	1000
CHAB-2	17.0	12.2	
CHAB-3	26.0	21.2	

用途：可快速固定電線，安裝容易。

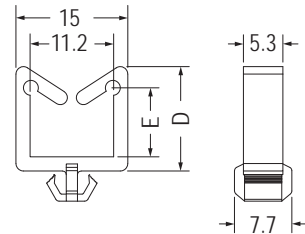

MOUNTING HOLE
THICKNESS 0.5~0.8

MOUNTING HOLE
THICKNESS 0.8~1.0

【 CHAB-4 】

【 CHAB-1L 】

Part No.	D	E	Package
CHAB-1L	12.0	7.2	1000
CHAB-4	14.0	9.3	

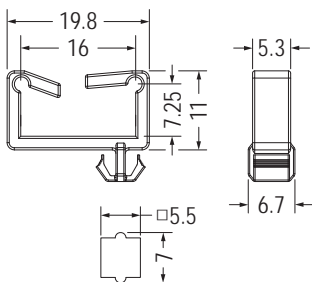

MOUNTING HOLE
THICKNESS 1.6

Part No.	Package
CHAB-5	1000

電線固定座 WIRE SADDLE

用途：固定電線於PC板或機板上，維修方便，不佔空間。

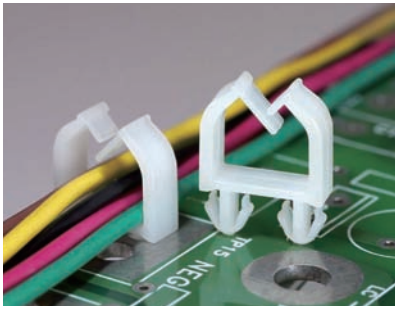

- Material: Nylon 66 (UL)
- Flame Class: 94V-2/94V-0
- Color: Natural/Black
- Unit: mm

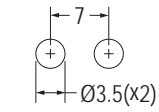
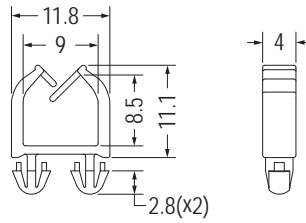

MOUNTING HOLE THICKNESS 1.6

Part No.	Package
MWSG-1	1000

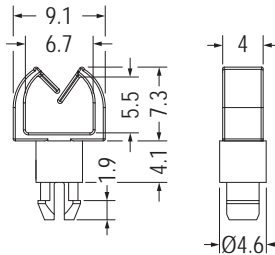
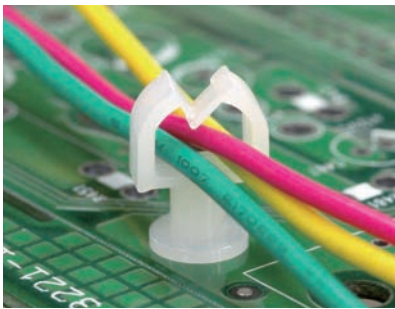

MOUNTING HOLE Ø3.8 THICKNESS 1.6

Part No.	Package
MWSA-2	1000

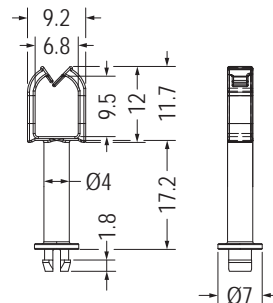

MOUNTING HOLE Ø3.8 THICKNESS 1.7

Part No.	Package
MWSA-17.2	1000

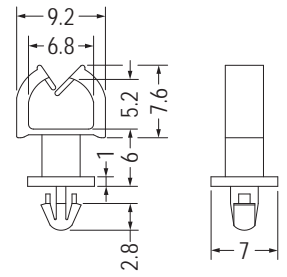

MOUNTING HOLE Ø3.0 THICKNESS 1.0-1.6

Part No.	Package
MWSL-6	1000

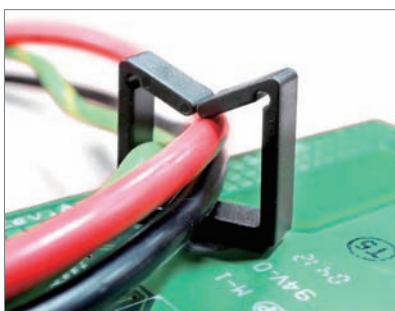

- Material: Nylon 66 (UL)
- Flame Class: 94V-2/94V-0
- Color: Natural/Black
- Unit: mm

用途：固定電線於木板或機殼上，維修方便，不佔空間。

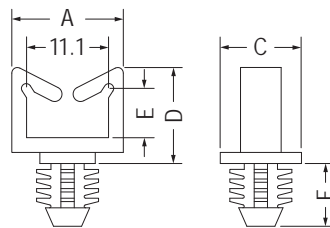

MOUNTING HOLE Ø7.9 THICKNESS 6.4

Part No.	A	C	D	E	F	Package
WSBH-7	15.1	11.0	13.0	6.7	8.5	1000
WSBH-12	15.5	11.1	18.3	12.3	8.5	
WSBH-19	15.2	11.1	27.2	21.0	8.7	
WSBH-29	15.1	11.0	35.0	28.7	8.5	

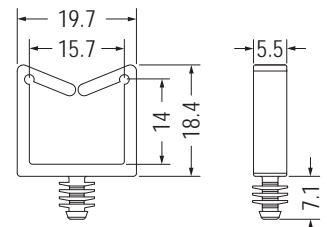

MOUNTING HOLE Ø5.3 THICKNESS 6.4

Part No.	Package
WSBH-13	1000

電線固定座 WIRE SADDLE

用途：固定電線於PC板或機板上，維修方便，不佔空間。

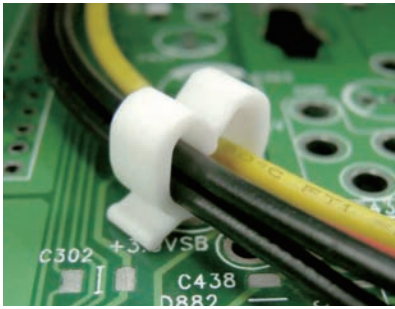

- Material: Nylon 66 (UL)
- Flame Class: 94V-2/94V-0
- Color: Natural/Black
- Unit: mm

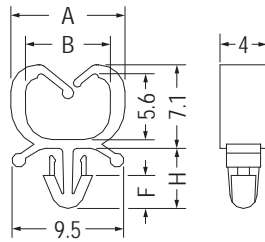

MOUNTING HOLE Ø3.0
THICKNESS 0.6-1.6

Part No.	A	B	F	H	Package
MWC-2	9.7	7.2	2.2	4.5	2000
★MWC-2S	10.0	7.0	2.2	4.5	
MWC-6	9.7	7.2	2.8	5.1	

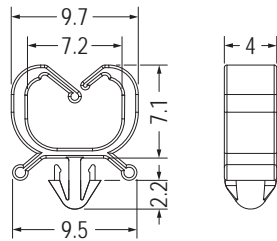

MOUNTING HOLE Ø3
THICKNESS 0.6-0.8

Part No.	Package
★MWC-4	2000

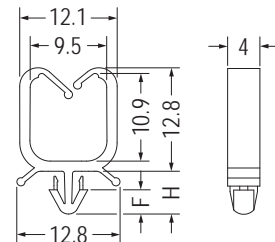

MOUNTING HOLE: ØG
THICKNESS 0.6-1.6

Part No.	F	G	H	Package
MWC-3	2.2	3.0	4.5	2000
MWC-10	3.0	3.5	5.3	

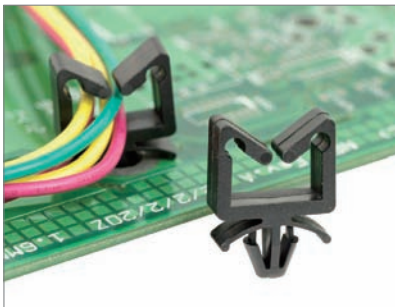

【CHA-3L】

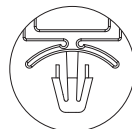

【CHA-5】

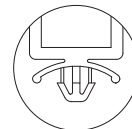

【CHA-6】



【CHA-9】



Part No.	A	B	C	D	E	G	T	Package	UL	
CHA-1	15.0	11.2	5.3	12.0	7.2	4.8~5.0	0.8~2.0	1000	UL	
CHA-1L	15.0	11.2	5.3	12.0	7.2	4.8~5.0	2.2			
CHA-2	15.0	11.2	5.3	17.0	12.2	4.8~5.0	0.8~2.0	500	UL	
CHA-3	15.0	11.2	5.3	26.0	21.2	4.8~5.0	0.8~2.0		UL	
CHA-3L	15.0	11.2	5.3	26.0	21.2	4.8~5.0	3.0			
CHA-4	15.0	11.2	5.3	34.0	29.2	4.8~5.0	0.8~2.0		UL	
CHA-5	15.1	11.1	5.6	17.8	11.65	4.75	1.6~3.2			
CHA-6	15.0	11.2	5.3	17.0	12.2	4.8	0.8~2.2			
CHA-6L	15.0	11.2	5.3	17.0	12.2	4.8	0.8~2.5			
CHA-9	15.0	10.6	5.2	20.0	15.3	4.8	0.8~2.2			
CHA-11	15.0	11.2	5.3	12.0	7.2	5.4	0.8~2.0		1000	

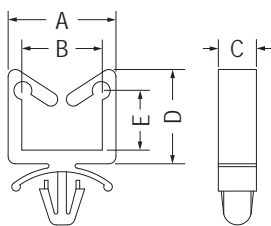

MOUNTING HOLE: ØG
THICKNESS: T

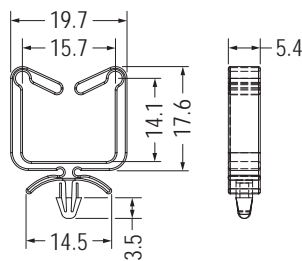

MOUNTING HOLE Ø3.0
THICKNESS 1.6-2.3

Part No.	Package
CHA-8	500

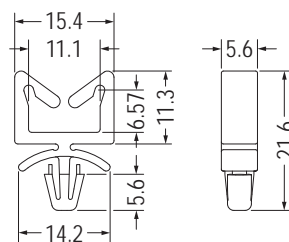

MOUNTING HOLE Ø4.75
THICKNESS 1.6

Part No.	Package
CHA-13	1000

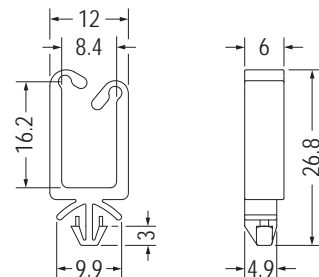

MOUNTING HOLE
THICKNESS 1.6

Part No.	Package
CHA-15	500

電線固定座 WIRE SADDLE

用途：固定電線於PC板或機板上，維修方便，不佔空間。

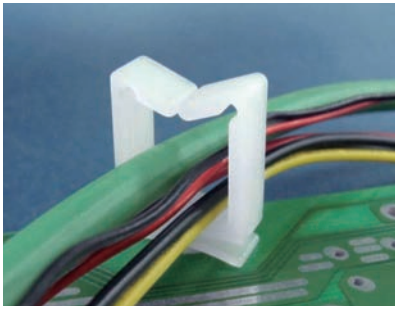

- Material: Nylon 66 (UL)
- Flame Class: 94V-2/94V-0
- Color: Natural/Black
- Unit: mm

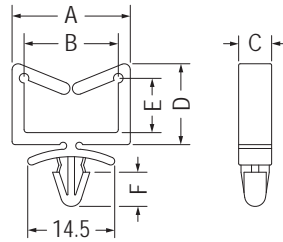

MOUNTING HOLE: $\varnothing G$
THICKNESS: T

Part No.	A	B	C	D	E	F	G	T	Package
CHP-1	19.7	15.7	5.4	18.2	14.0	5.7	4.8-5.0	1.2~2.1	500
CHP-2	15.0	11.0	5.5	17.0	12.6	5.7	4.8-5.0	1.2~2.1	
CHP-3	18.5	14.6	5.5	17.0	12.55	6.1	5.0	1.2~2.0	

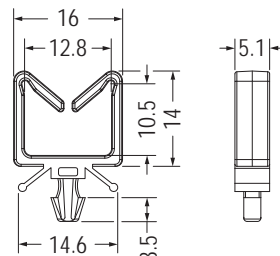
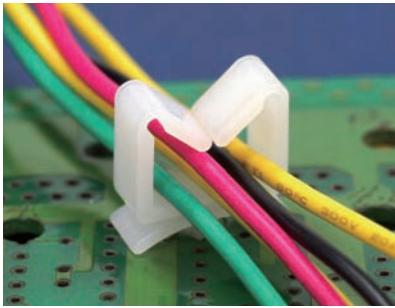

MOUNTING HOLE $\varnothing 3.4\text{-}\varnothing 3.5$
THICKNESS 2.5

Part No.	Package
CHPB-1	1000

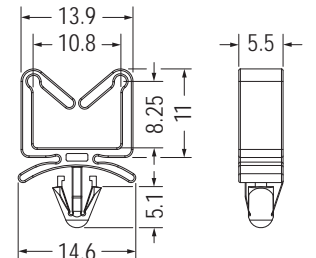

MOUNTING HOLE $\varnothing 4$
THICKNESS 1.6

Part No.	Package
CHA-10	1000

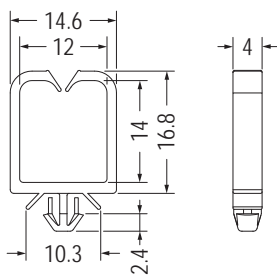

MOUNTING HOLE $\varnothing 4.0$
THICKNESS 0.8-2.0

Part No.	Package
MWS-34	500

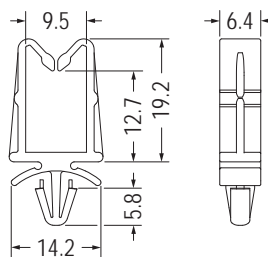

MOUNTING HOLE $\varnothing 4.7\text{-}\varnothing 4.9$
THICKNESS 0.8-2.0

Part No.	Package
CHA-14	500

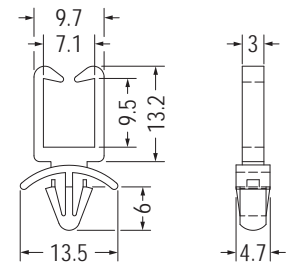

MOUNTING HOLE $\varnothing 4.8$
THICKNESS 0.8-1.6

Part No.	Package
CHAD-1	1000

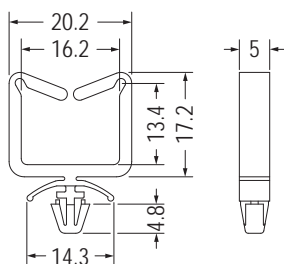

MOUNTING HOLE $\varnothing 4.8$
THICKNESS 1.0-2.5

Part No.	Package
CHR-11	500

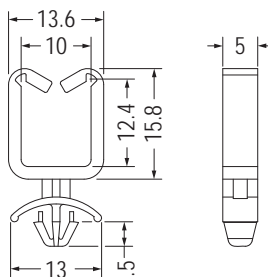

MOUNTING HOLE $\varnothing 5.0$
THICKNESS 0.8-1.6

Part No.	Package
CHX-1	1000

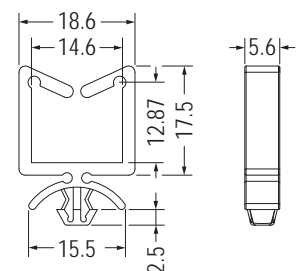

MOUNTING HOLE $\varnothing 5.0$
THICKNESS 2.4-3.0

Part No.	Package
CHPA-1	1000

電線固定座 WIRE SADDLE

用途：固定電線於PC板或機板上，維修方便，不佔空間。

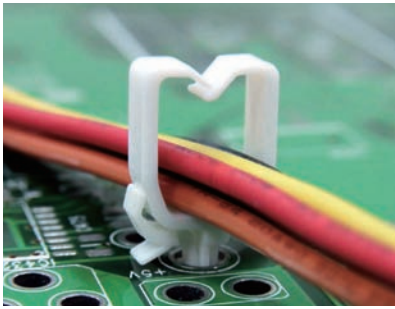

- Material: Nylon 66 (UL)
- Flame Class: 94V-2/94V-0
- Color: Natural/Black
- Unit: mm

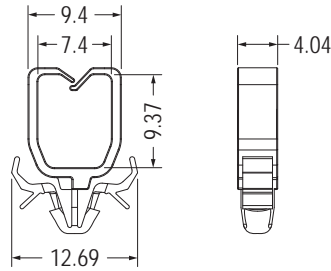

MOUNTING HOLE Ø3.5
THICKNESS 0.6~1.6

Part No.	Package
MWSB-1	2000

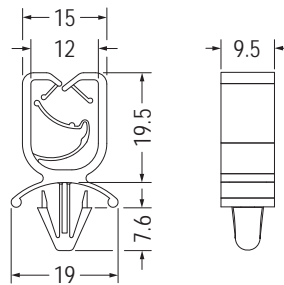

MOUNTING HOLE Ø6.3~Ø7.0
THICKNESS 0.6~3.0

Part No.	Package
MWCA-1	1000

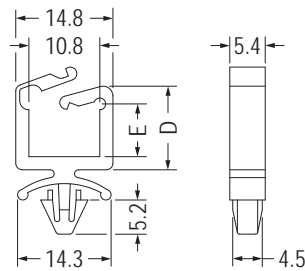

MOUNTING HOLE Ø4.8~Ø5.0
THICKNESS 0.5~2.0

Part No.	D	E	Package
CH-10	15.9	11.2	500
CH-19	25.2	20.5	

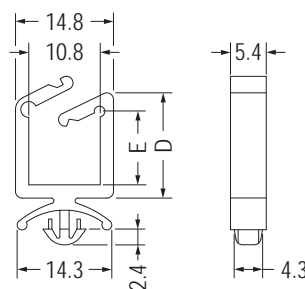

MOUNTING HOLE Ø4.8
THICKNESS 0.8~1.6

Part No.	D	E	Package
CH-11	15.9	11.1	500
CH-13	20.6	15.8	

電線固定座 WIRE SADDLE

用途：固定電線於PC板或機板上，維修方便，不佔空間。

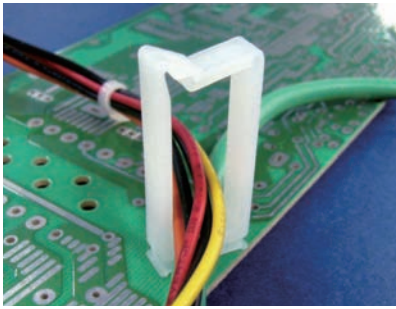

- Material: Nylon 66 (UL)
- Flame Class: 94V-2/94V-0
- Color: Natural/Black
- Unit: mm

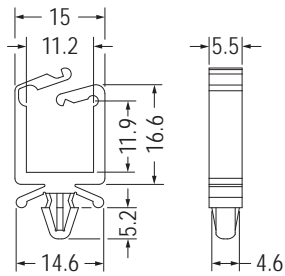

MOUNTING HOLE Ø4.8
THICKNESS 0.8-1.8

Part No.	Package
CH-14	500

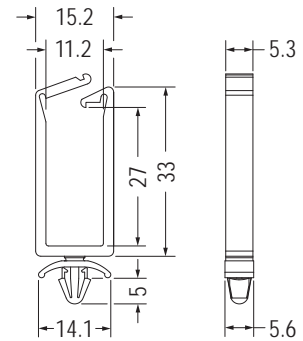

MOUNTING HOLE Ø4.8
THICKNESS: T

Part No.	T	Package
CH-15	0.5-2.3	500
CH-15L	1.5-3.0	

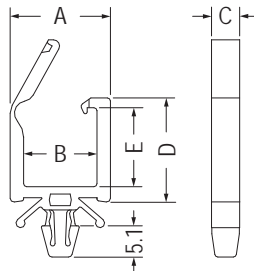
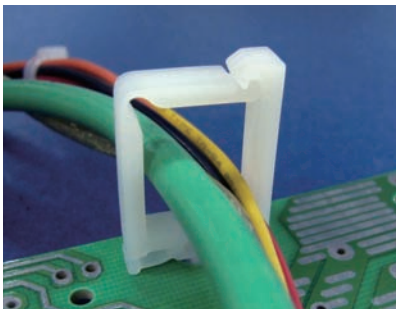

MOUNTING HOLE Ø4.8
THICKNESS 0.5-2.0

Part No.	A	B	C	D	E	Package
CHF-1	16.4	12.0	4.6	21.5	17.4	500
CHF-2	14.4	10.4	4.6	16.5	12.4	
CHF-3	18.4	14.0	5.0	24.0	20.0	

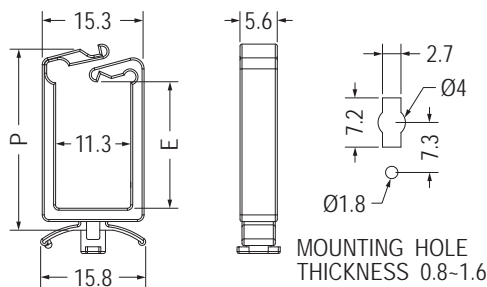

MOUNTING HOLE
THICKNESS 0.8-1.6

Part No.	E	P	Package
CHZC-1	4.8	13.0	500
CHZC-2	9.8	18.8	
CHZC-3	19.0	27.2	
CHZC-4	26.8	35.1	

電線固定座 WIRE SADDLE

用途：固定電線於PC板或機板上，維修方便，不佔空間。

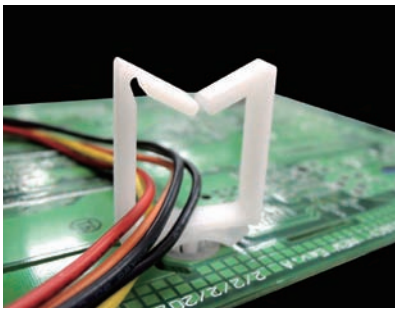

- Material: Nylon 66 (UL)
- Flame Class: 94V-2/94V-0
- Color: Natural/Black
- Unit: mm

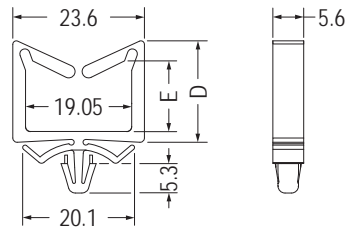

MOUNTING HOLE $\varnothing 4.75$
THICKNESS 1.2

Part No.	D	E	Package
CHAH-1	18.2	12.7	500
CHAH-2	27.1	21.6	

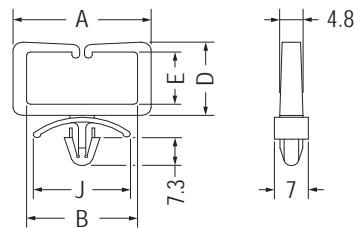
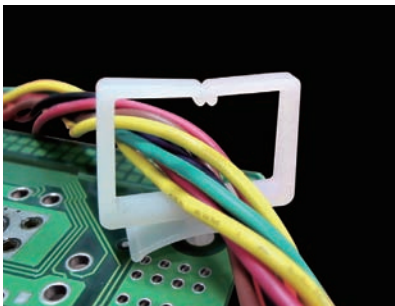

MOUNTING HOLE $\varnothing 4.8-\varnothing 5.0$
THICKNESS: T

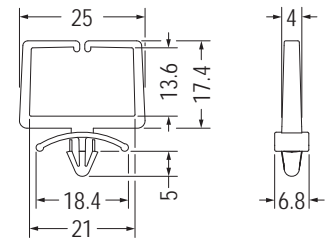

MOUNTING HOLE $\varnothing 4.8-\varnothing 5.0$
THICKNESS 0.8-2.5

Part No.	A	B	D	E	J	T	Package
CHE-1	28.5	22.9	19.2	13.6	20.2	1.1-3.5	500
CHE-2	42.0	36.0	66.0	60.3	20.1	0.8-4.0	

Part No.	Package
CHE-3	500

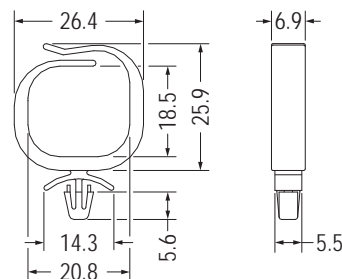

MOUNTING HOLE $\varnothing 4.8-\varnothing 5.5$
THICKNESS 0.8-2.0

Part No.	Package
CHD-18	250

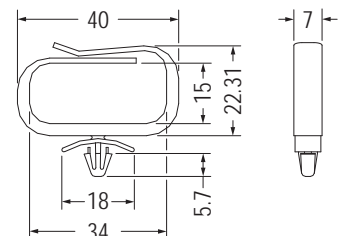

MOUNTING HOLE $\varnothing 4.8-\varnothing 5.5$
THICKNESS 0.8-2.0

Part No.	Package
CHD15-34	250

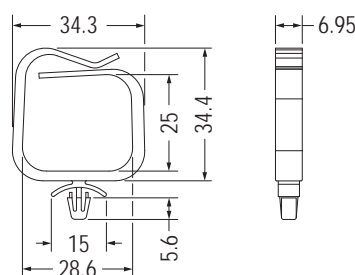

MOUNTING HOLE $\varnothing 4.8$
THICKNESS 0.8-2.0

Part No.	Package
CHD-20	250

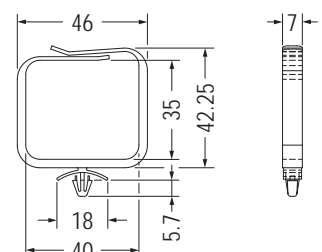

MOUNTING HOLE $\varnothing 4.8$
THICKNESS 0.8-2.0

Part No.	Package
CHD35-40	200

電線固定座 WIRE SADDLE

用途：固定電線於PC板或機板上，維修方便，不佔空間。

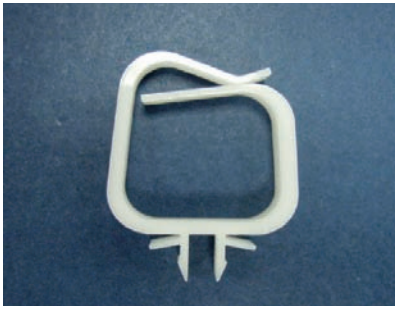

- Material: Nylon 66 (UL)
- Flame Class: 94V-2/94V-0
- Color: Natural/Black
- Unit: mm

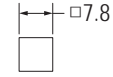
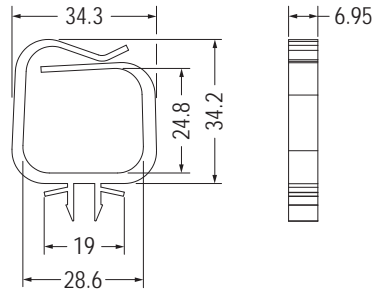

MOUNTING HOLE THICKNESS 0.8-2.0

Part No.	Package
CHD-19	250

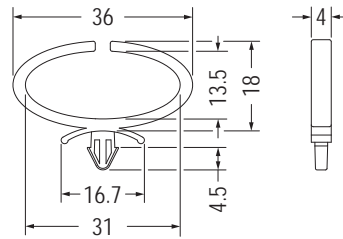

MOUNTING HOLE THICKNESS 0.8-2.0

Part No.	Package
WUCD-36	1000

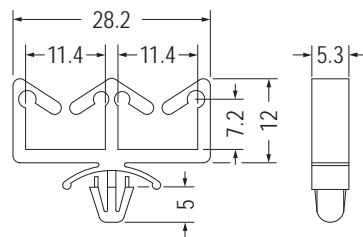
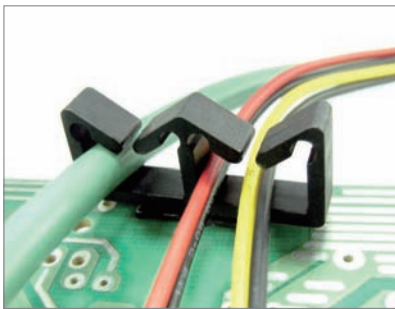

【 CHAA-3 】

MOUNTING HOLE: ØG THICKNESS 1.2-2.1

Part No.	G	Package
CHAA-1	4.8-5.0	1000
CHAA-3	4.8	

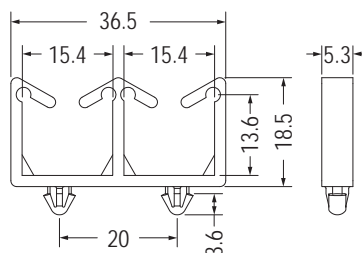

MOUNTING HOLE Ø4.0 THICKNESS 1.0

Part No.	Package
CHAA-4	500

電線固定座 WIRE SADDLE

用途：固定電線於PC板或機板上，維修方便，不佔空間。

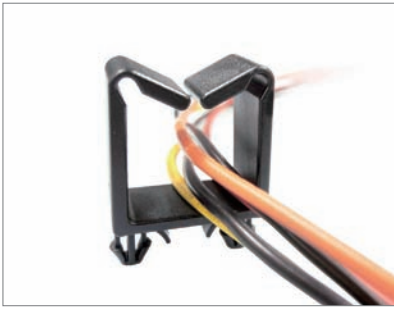

- Material: Nylon 66 (UL)
- Flame Class: 94V-2/94V-0
- Color: Natural/Black
- Unit: mm

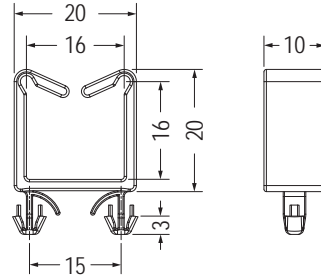

MOUNTING HOLE Ø4.0
THICKNESS 0.8-2.5

Part No.	Package
CHAF-3	1000

4

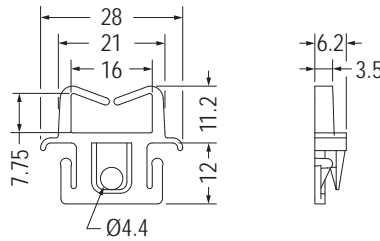
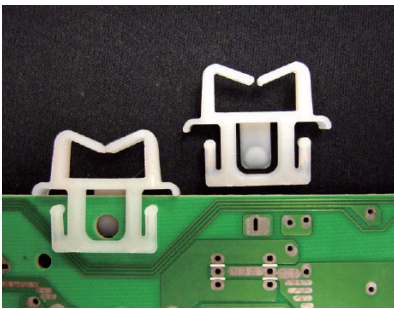

MOUNTING DETAIL

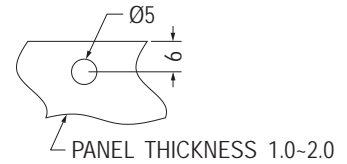

Part No.	Package
EDGE-1	500

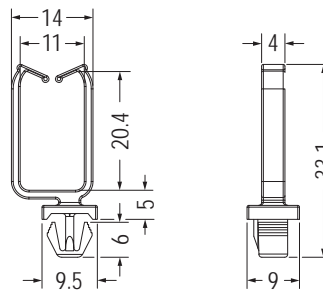
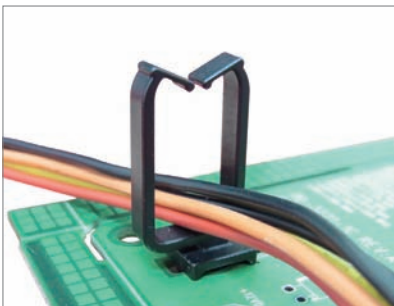

MOUNTING HOLE
THICKNESS 0.8-2.0

Part No.	Package
WSSA-1	500

電線固定座 WIRE SADDLE

用途：用於固定電線。

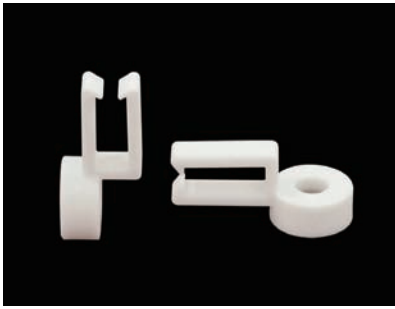

- Material: Nylon 66 (UL)
- Flame Class: 94V-2/94V-0
- Color: Natural/Black
- Unit: mm

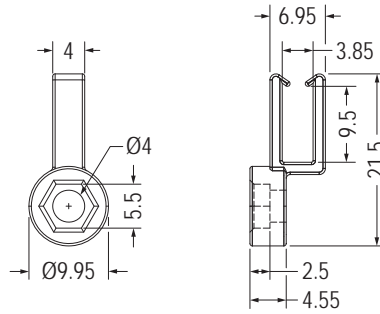

Part No.	Package
THP-1	500



- Material: Nylon 66 (UL)
- Flame Class: 94V-2/94V-0
- Color: Natural/Black
- Unit: mm

用途：將電線固定於LCD-TV上，電線不易磨損，配線整齊美觀。

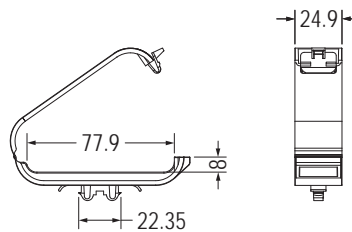

MOUNTING HOLE THICKNESS 1.0-2.5

Part No.	Package
CMKB-1	50

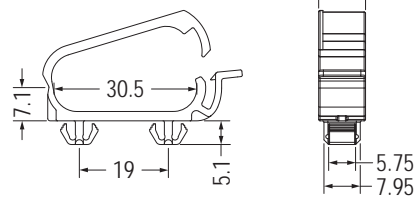

MOUNTING HOLE THICKNESS 0.8-1.2

Part No.	Package
CMKB-2	250

電線固定座 WIRE MOUNT

用途：將電線固定於LCD-TV上，電線不易磨損，配線整齊美觀。



- Material: PP (UL)
- Flame Class: 94HB
- Color: Computer/Black
- Unit: mm

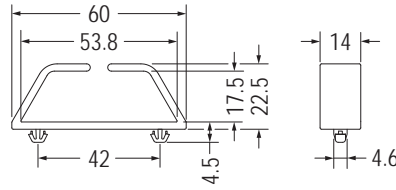

MOUNTING HOLE $\varnothing 4.8$
THICKNESS 1.5

Part No.	Package
CHT-42	100

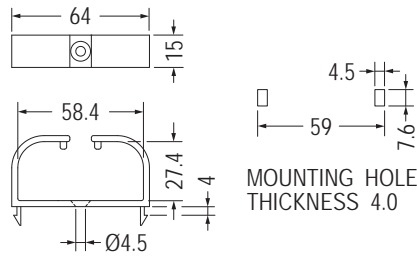

MOUNTING HOLE
THICKNESS 4.0

Part No.	Package
CHV-59	100

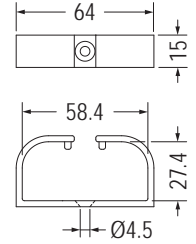

Part No.	Package
CHV-59K	100

4



- Material: PP (UL)
- Flame Class: 94HB
- Color: Natural
- Unit: mm

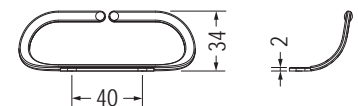
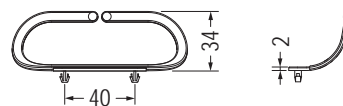
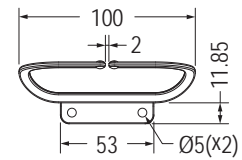
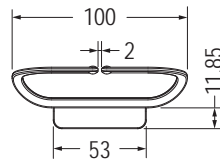

MOUNTING HOLE $\varnothing 4.0$
THICKNESS 2.8

Part No.	Package
WUCD-100	100

Part No.	Package
WUCDF-100	100

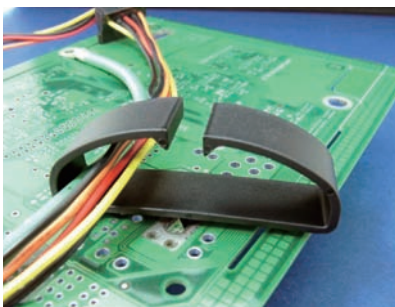

- Material: Nylon 66 (UL)
- Flame Class: 94V-2/94V-0
- Color: Natural/Black
- Unit: mm

用途：固定電線於PC板或機板上，維修方便，不佔空間。

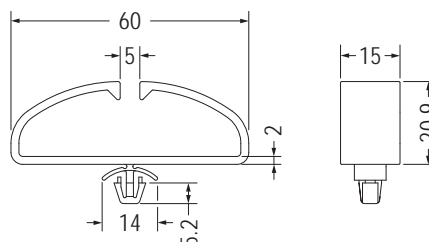

MOUNTING HOLE $\varnothing 6.0$
THICKNESS 0.8-2.5

Part No.	Package
CHAU-1	500

電線固定座 WIRE SADDLE

用途：固定電線於PC板或機板上，維修方便，不佔空間。

- Material: Nylon 66 (UL)
- Flame Class: 94V-2/94V-0
- Color: Natural/Black
- Unit: mm

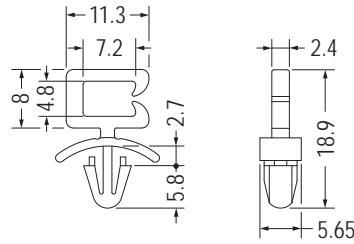
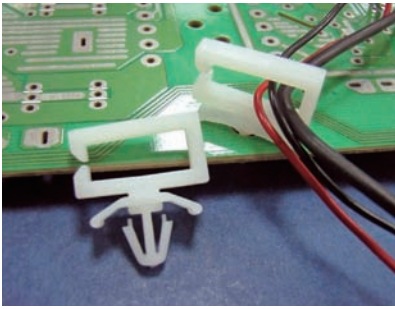

MOUNTING HOLE Ø4.8
THICKNESS 0.8-2.0

Part No.	Package
WAS-1	1000

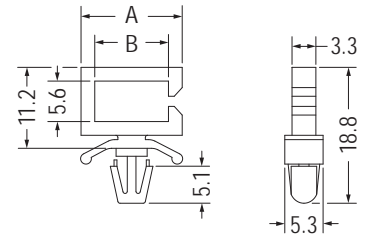

MOUNTING HOLE Ø4.8
THICKNESS 0.8-2.0

Part No.	A	B	Package
WSS-2	14.0	10.2	1000
WSS-2L	17.0	13.2	

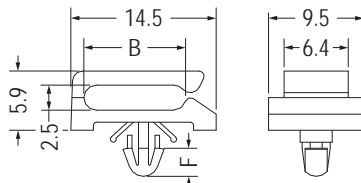
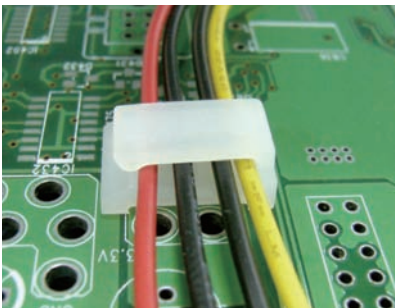

MOUNTING HOLE: ØG
THICKNESS: T

Part No.	B	F	G	T	Package
MIS-2	10.2	2.8	3.0	0.6-1.8	1000
MIS-9	10.15	3.15	4.0	1.6	

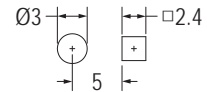
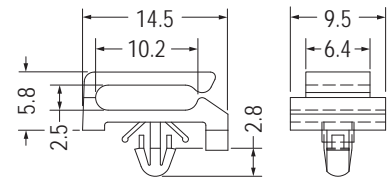

MOUNTING HOLE Ø3.0
THICKNESS: T

Part No.	T	Package
MIS-11	0.6-1.8	2000
MIS-11L	1.0-2.2	

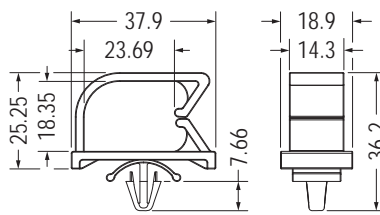

MOUNTING HOLE Ø6.4
THICKNESS 1.9

Part No.	Package
MIS-20	250

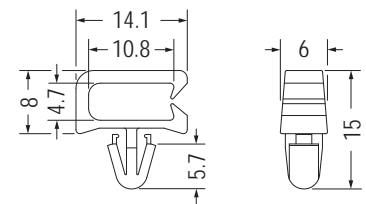

MOUNTING HOLE Ø4.8
THICKNESS 0.8-1.6

Part No.	Package
MIS-3	2000

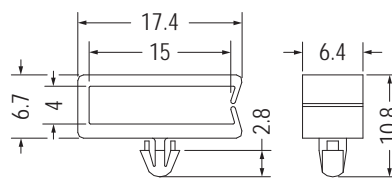
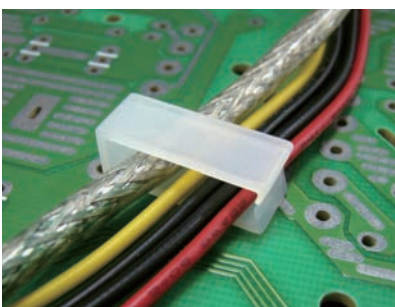

MOUNTING HOLE Ø3.0
THICKNESS 1.0

Part No.	Package
MIS-5	2000

電線固定座 WIRE SADDLE

用途：固定電線於PC板或機板上，維修方便，不佔空間。

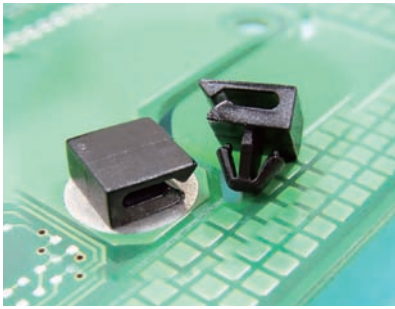

- Material: Nylon 66 (UL)
- Flame Class: 94V-2/94V-0
- Color: Natural/Black
- Unit: mm

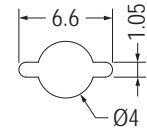
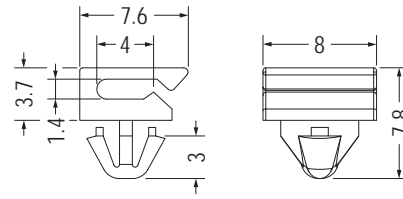

MOUNTING HOLE THICKNESS 0.8

Part No.	Package
MIS-14	2000

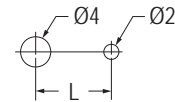
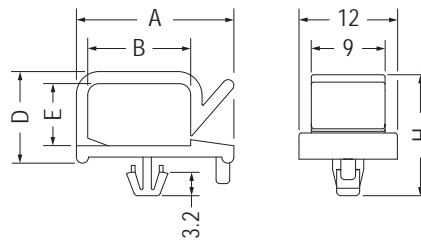

MOUNTING HOLE THICKNESS: T

Part No.	A	B	D	E	H	L	T	Package
MIS-7	20.8	13.6	12.5	8.2	16.9	10.0	0.6-0.8	500
MIS-7M	20.8	13.6	12.5	8.2	17.0	10.0	0.8-1.2	
MIS-8	16.8	10.5	10.3	6.5	14.3	7.0	0.8-1.0	
MIS-8M	16.8	10.5	10.3	6.5	14.8	7.0	1.2	
MIS-8L	16.8	10.5	10.3	6.5	15.2	7.0	1.6	

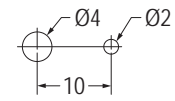
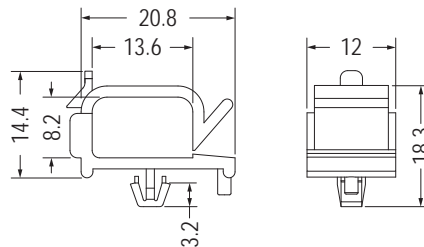
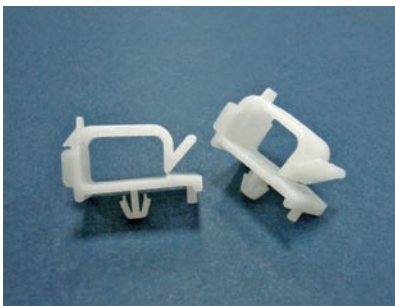

MOUNTING HOLE THICKNESS 0.6-1.0

Part No.	Package
MIS-10	1000

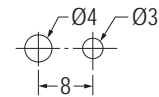
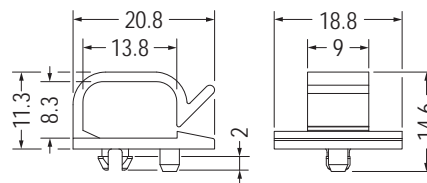
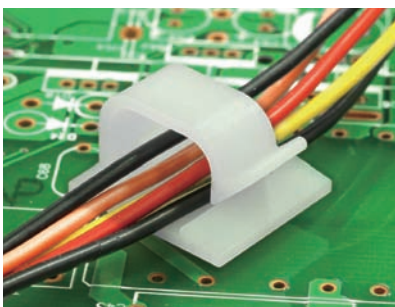

MOUNTING HOLE THICKNESS 1.0

Part No.	Package
MIS-17	1000

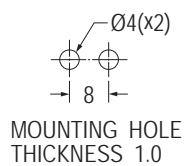
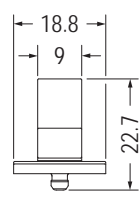
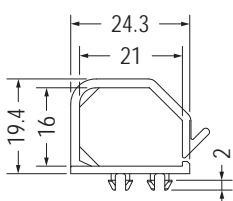

MOUNTING HOLE THICKNESS 1.0

Part No.	Package
MIS-21	1000

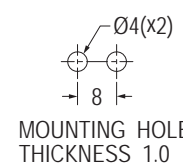
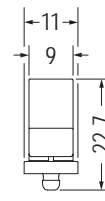
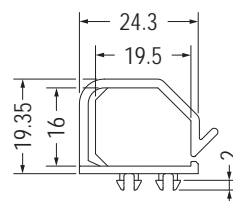

MOUNTING HOLE THICKNESS 1.0

Part No.	Package
MIS-29	500

電線固定座 WIRE SADDLE

用途：固定電線於PC板或機板上，維修方便，不佔空間。



- Material: Nylon 66 (UL)
- Flame Class: 94V-2/94V-0
- Color: Natural/Black
- Unit: mm

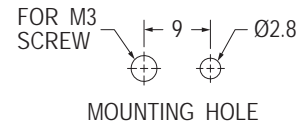
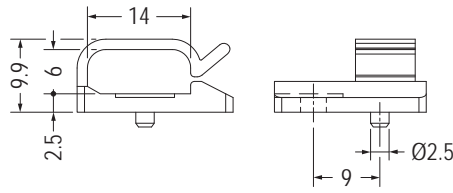

Part No.	Package
WCLB-1	1000

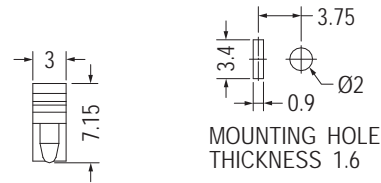
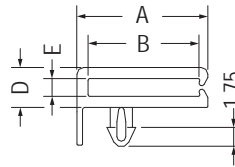
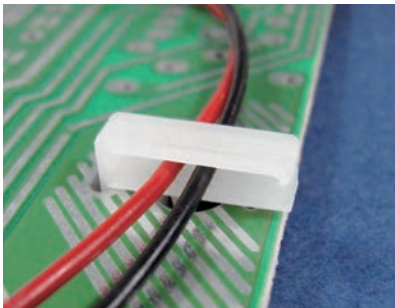

Part No.	A	B	D	E	Package
MIS-4	11.8	10.0	3.6	1.6	1000
MIS-23	14.8	12.48	4.3	2.3	

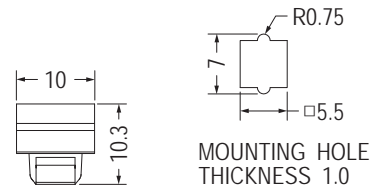
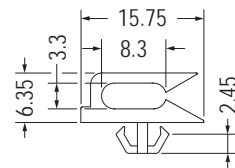
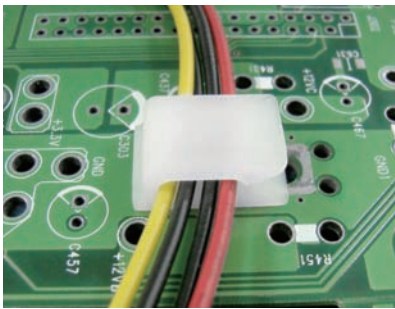

Part No.	Package
MIS-6	1000

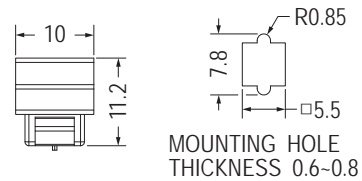
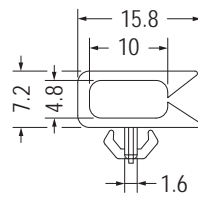

Part No.	Package
MIS-28	1000

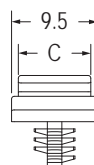
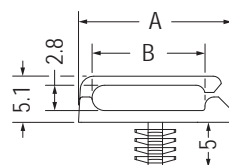
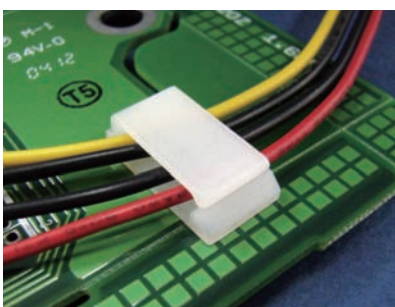

Part No.	A	B	C	Package
MISB-1	17.0	12.5	8.0	1000
MISB-2	12.7	8.3	6.4	

電線固定座 WIRE SADDLE

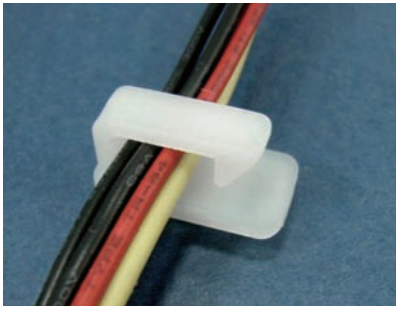

- Material: Nylon 66 (UL)
- Flame Class: 94V-2/94V-0
- Color: Natural/Black
- Unit: mm

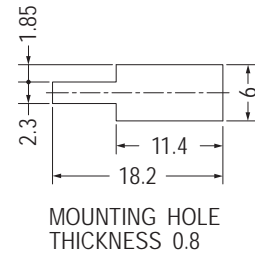
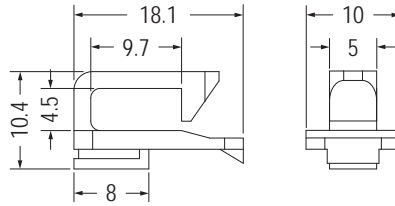

MOUNTING HOLE THICKNESS 0.8

Part No.	Package
MISA-1	1000

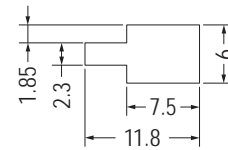
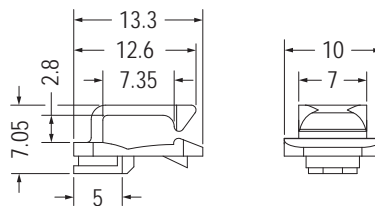
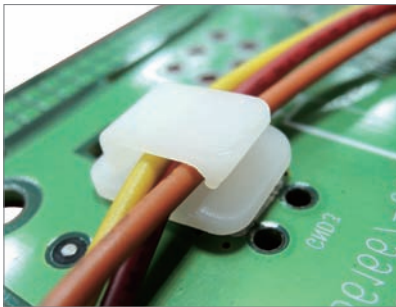

MOUNTING HOLE THICKNESS 0.9

Part No.	Package
MISA-2	1000

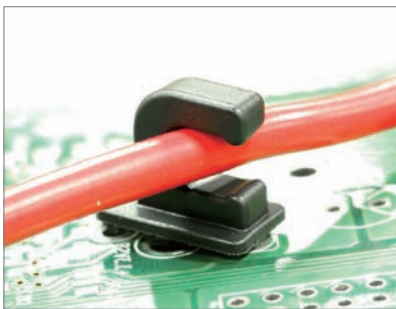

- Material: ABS (UL)
- Flame Class: 94V-0
- Color: Black
- Unit: mm

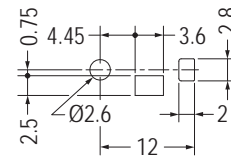
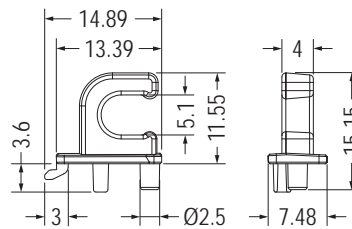

MOUNTING HOLE THICKNESS 0.6

Part No.	Package
MISE-1	1000

電線固定座 CABLE CLAMP

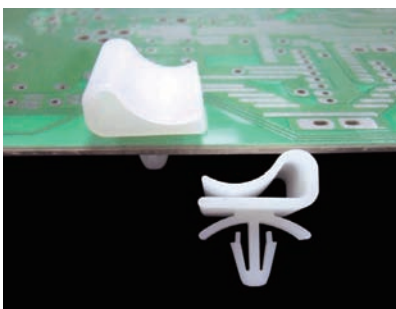

- Material: Nylon 66 (UL)
- Flame Class: 94V-2/94V-0
- Color: Natural/Black
- Unit: mm

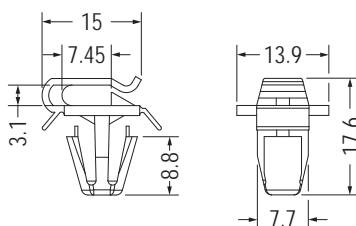

MOUNTING HOLE Ø8.0 THICKNESS 1.0-2.8

Part No.	Package
FCCA-1	1000

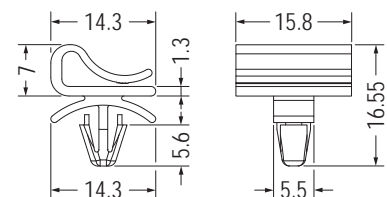

MOUNTING HOLE Ø4.8 THICKNESS 0.6-2.0

Part No.	Package
FCCB-1	1000

用途：快速拆卸，固定電線維修方便，不佔空間。

用途：快速固定電線，安裝容易。

電線固定座 CABLE CLAMP

用途：快速固定電線，安裝容易。

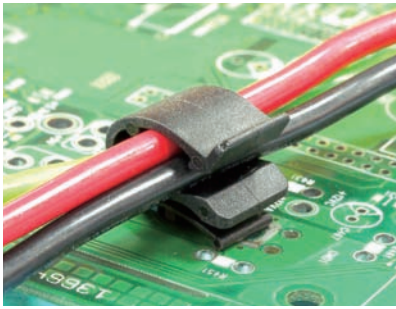

- Material: Nylon 66 (UL)
- Flame Class: 94V-2/94V-0
- Color: Natural/Black
- Unit: mm

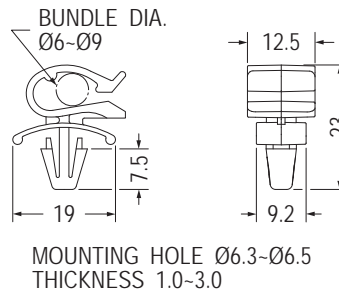

Part No.	Package
FCCD-1	1000

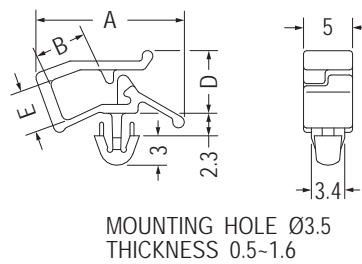
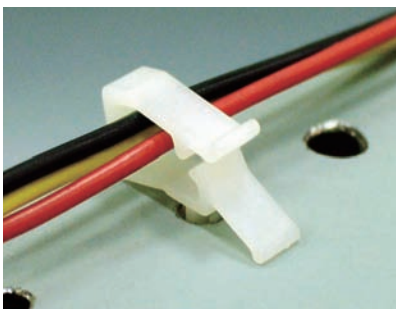

Part No.	A	B	D	E	Package
WPEM-1	20.3	7.2	8.5	6.2	1000
WPEM-1S	15.2	5.3	6.4	4.3	
WPEM-2	13.5	4.1	5.0	2.6	



- Material: Nylon 66 (UL)
- Flame Class: 94V-2/94V-0
- Color: Natural/Black
- Unit: mm

用途：用於電子、電腦內部排線固定，裝配容易，美觀不脫落，固定力強。

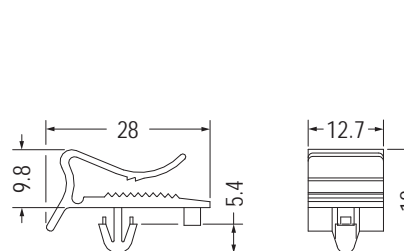

Part No.	Package
FCCT-12	500

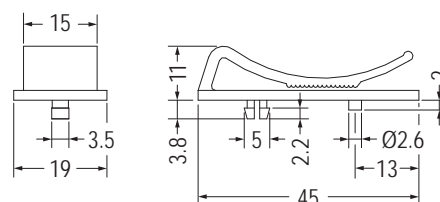
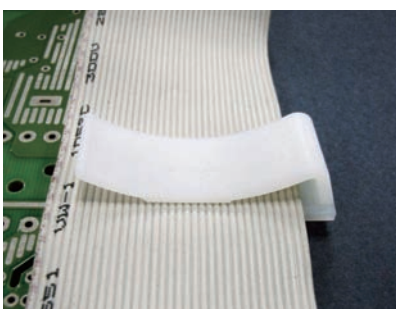

Part No.	Package
FCG-15	1000

電線固定座 CABLE CLAMP

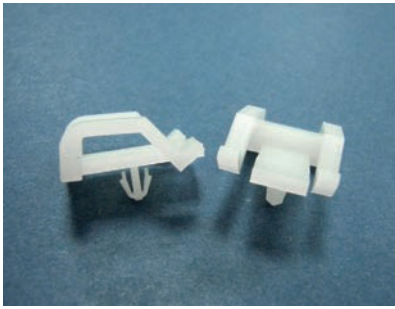

- Material: Nylon 66 (UL)
- Flame Class: 94V-2/94V-0
- Color: Natural/Black
- Unit: mm

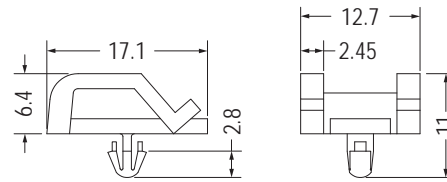

MOUNTING HOLE $\varnothing 3.0$
THICKNESS 1.6

Part No.	Package
FCPT-1	1000

用途：固定電線於PC板或機板上，維修方便，不佔空間。

電線固定座 WIRE SADDLE

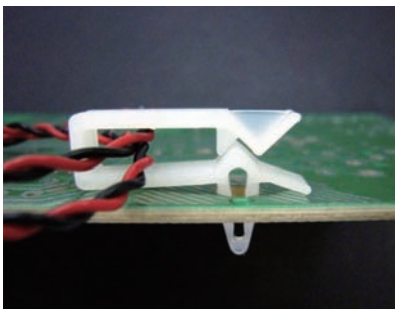

- Material: Nylon 66 (UL)
- Flame Class: 94V-2/94V-0
- Color: Natural/Black
- Unit: mm

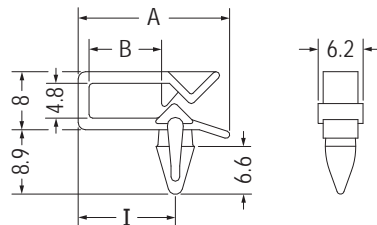

MOUNTING HOLE $\varnothing 4.8$
THICKNESS 2.0

用途：固定電線於PC板或機板上，維修方便，不佔空間。

Part No.	A	B	I	Package
WPEG-1	20.9	10.0	13.4	1000
WPEG-2	24.2	13.2	16.8	
WPEG-3	17.5	6.6	10.8	

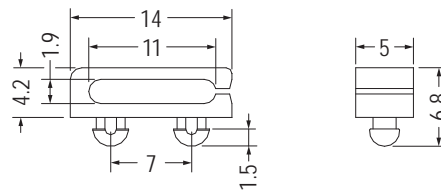
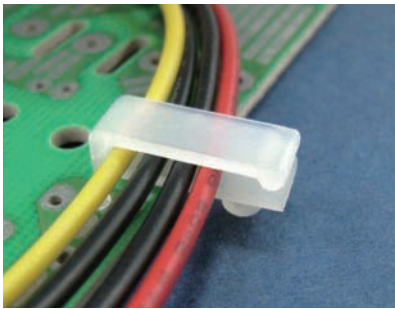

MOUNTING HOLE $\varnothing 3.0$
THICKNESS 0.8-1.0

Part No.	Package
MWS-4	2000

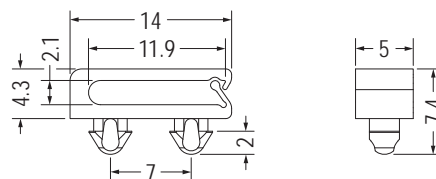
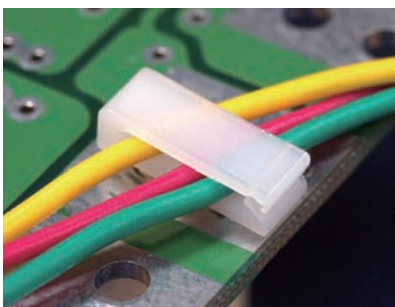

MOUNTING HOLE $\varnothing 3.0$
THICKNESS 0.8-1.0

Part No.	Package
MIS-18	1000

電線固定座 WIRE SADDLE

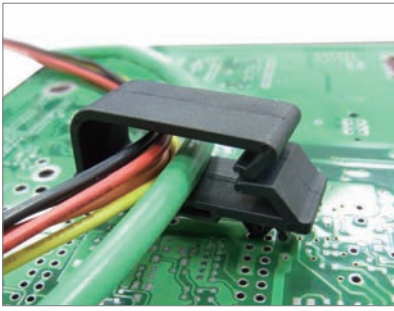

- Material: Nylon 66 (UL)
- Flame Class: 94V-2/94V-0
- Color: Natural/Black
- Unit: mm

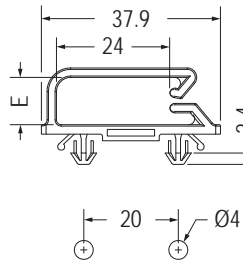

MOUNTING HOLE THICKNESS 0.8-2.0

Part No.	E	Package
MIBA-1	18.7	200
MIBA-2	10.0	500

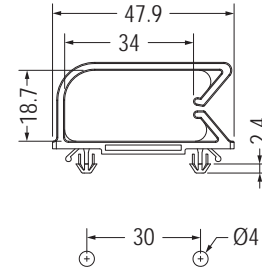

MOUNTING HOLE THICKNESS 0.8-2.0

Part No.	Package
MIBA-3	500

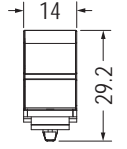

用途：固定電線於PC板或機板上，維修方便，不佔空間。

電線固定扣 CABLE CLAMP

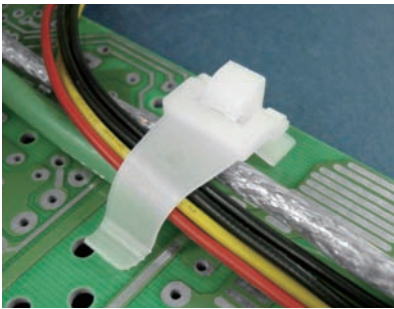

- Material: Nylon 66 (UL)
- Flame Class: 94V-2/94V-0
- Color: Natural/Black
- Unit: mm

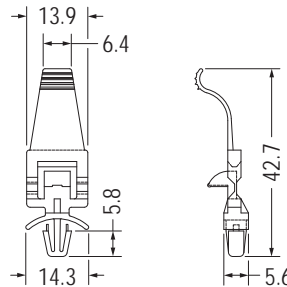

MOUNTING HOLE Ø4.8 THICKNESS 1.2-2.0

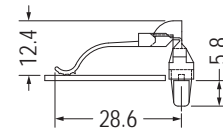
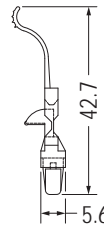

Part No.	Package
HFCC-12	1000

用途：可快速固定電線，安裝容易。

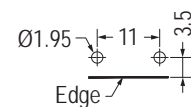
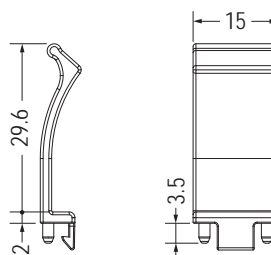

MOUNTING HOLE THICKNESS 2.1

Part No.	Package
HFCD-29	1000

電線固定座 CABLE CLAMP



- Material: Nylon 66 (UL)
- Flame Class: 94V-2/94V-0
- Color: Natural/Black
- Unit: mm

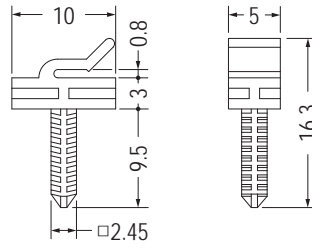

MOUNTING HOLE Ø3.0

用途：固定電線於木板或機殼上，維修方便，不佔空間。

Part No.	Package
WSBC-1	1000



- Material: Nylon 66 (UL)
- Flame Class: 94V-2/94V-0
- Color: Natural/Black
- Unit: mm

用途：固定電線於機板上，維修方便，不佔空間。

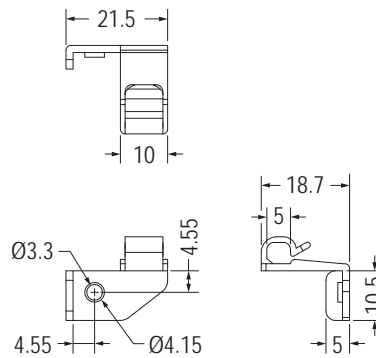

Part No.	Package
MISA-4	1000

風扇束線座 FAN CABLE TIE MOUNT

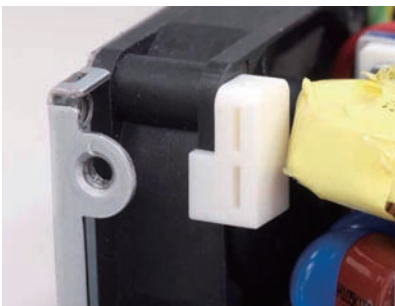

- Material: Nylon 66 (UL)
- Flame Class: 94V-2/94V-0
- Color: Natural/Black
- Unit: mm

用途：風扇電線之固定，整齊美觀。

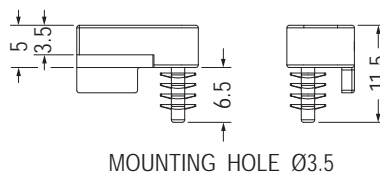

MOUNTING HOLE Ø3.5

Part No.	Package
WKM-2	1000

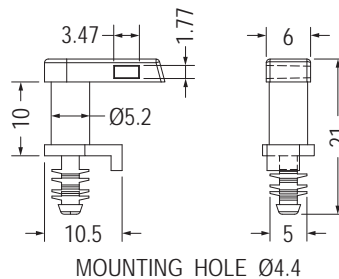

MOUNTING HOLE Ø4.4

Part No.	Package
WKM-10	500

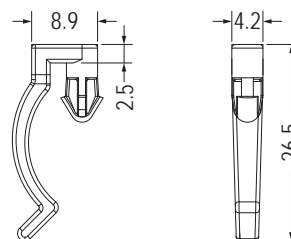
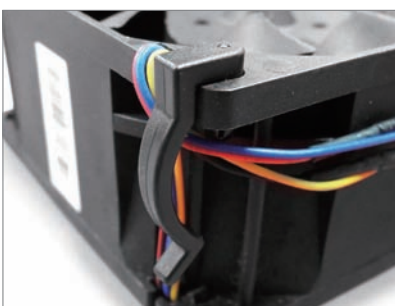

MOUNTING HOLE Ø4.3
THICKNESS 4.0

Part No.	Package
WKA-1	1000

電線固定座 CABLE CLAMP

用途：固定電線於PC板或機板上，維修方便，不佔空間。

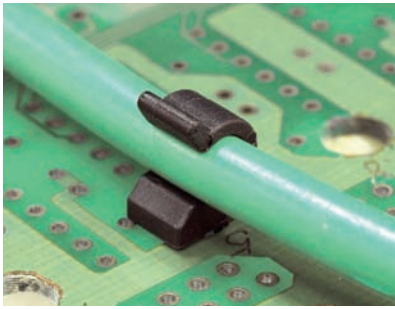

- Material: Nylon 66 (UL)
- Flame Class: 94V-2/94V-0
- Color: Natural/Black
- Unit: mm

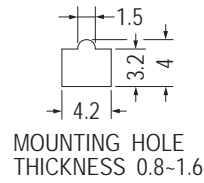
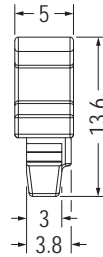
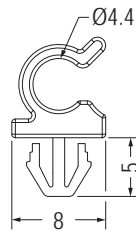

Part No.	Package
CHQ-4.5	1000

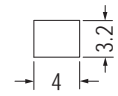
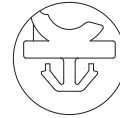
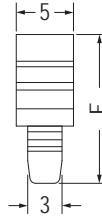
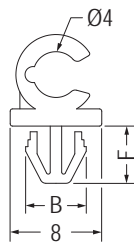
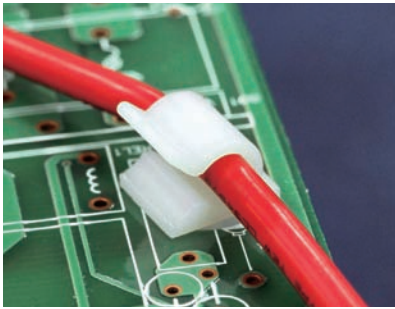

【 CHQ-4S 】

MOUNTING HOLE THICKNESS: T

Part No.	B	E	F	T	Package
CHQ-4	5.3	13.0	5.0	1.0-1.6	1000
CHQ-4S	4.9	10.9	2.9	1.0	
CHQ-4L	5.5	13.0	5.0	1.0-1.6	

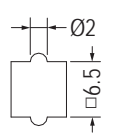
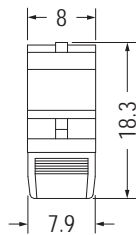
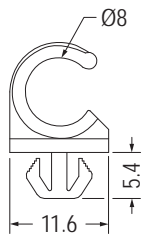

MOUNTING HOLE THICKNESS 0.8-1.6

Part No.	Package
CH-9	1000

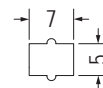
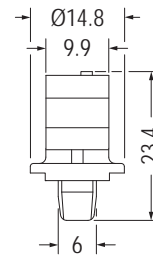
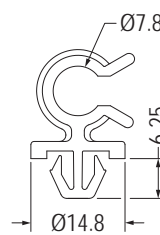

MOUNTING HOLE THICKNESS 0.8-1.2

Part No.	Package
CH-12	1000

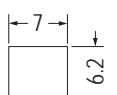
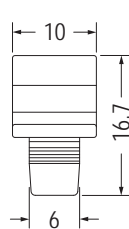
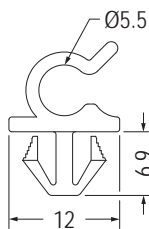

MOUNTING HOLE THICKNESS: T

Part No.	T	Package
CHQC-1	2.0	1000
CHQC-1L	0.7-2.0	

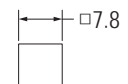
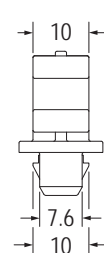
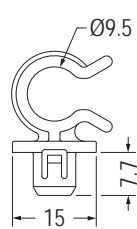

MOUNTING HOLE THICKNESS 1.8

Part No.	Package
CHQF-1	1000

電線固定座 WIRE HOLDER

用途：固定電線於機板上，維修方便，不佔空間。



- Material: Nylon 66 (UL)
- Flame Class: 94V-2/94V-0
- Color: Natural/Black
- Unit: mm

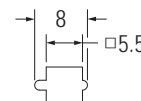
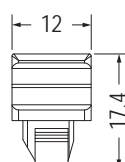
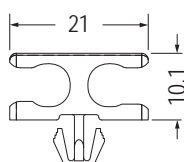

MOUNTING HOLE THICKNESS 2.5

Part No.	Package
CHQE-1	1000

電線固定座 WIRE HOLDER

用途：可快速固定及解開電線。

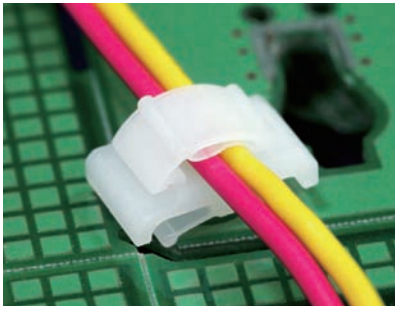

- Material: Nylon 66 (UL)
- Flame Class: 94V-2/94V-0
- Color: Natural/Black
- Unit: mm

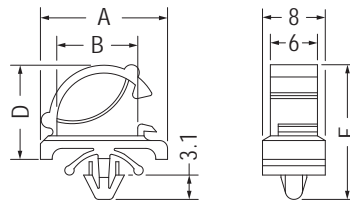

MOUNTING HOLE $\varnothing 3.5$
THICKNESS: T

Part No.	A	B	D	E	T	Package
WLO-1	13.5	6.2	8.2	14.0	0.8-2.0	1000
WLO-1-2.5	13.5	6.2	8.6	14.6	0.8-2.5	
WLO-2	16.2	10.3	12.0	17.6	0.8-2.0	
WLO-2-2.5	16.2	10.3	12.0	18.0	0.8-2.5	

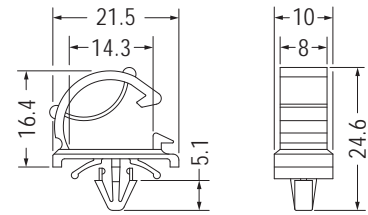

MOUNTING HOLE $\varnothing 4.8$
THICKNESS 0.8-2.5

Part No.	Package
WLO-3	500

電線固定座 CABLE CLAMP

用途：固定電線於PC板或機板上，維修方便，不佔空間。

4



- Material: Nylon 66 (UL)
- Flame Class: 94V-2/94V-0
- Color: Natural/Black
- Unit: mm

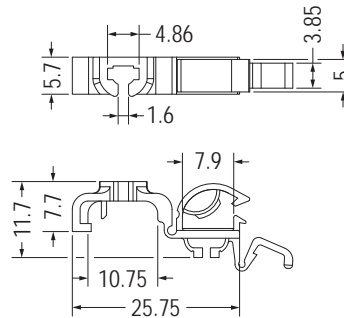

Part No.	Package
EMF-6	500

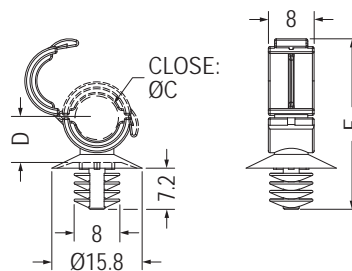
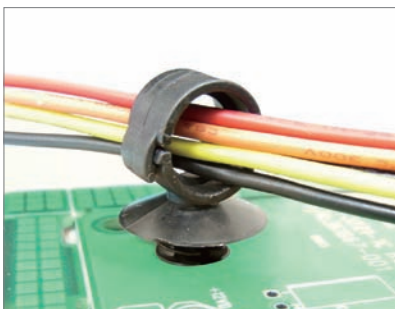

MOUNTING HOLE $\varnothing 6.5-\varnothing 7.0$
THICKNESS 0.8-9.0

Part No.	C	D	E	Package
CCMK-1	5.5	6.3	24.4	1000
CCMK-2	8.0	7.7	29.8	

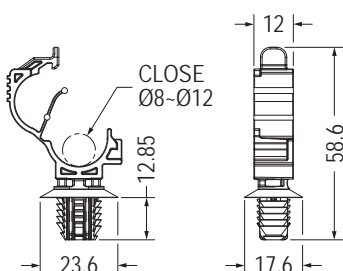

MOUNTING HOLE
THICKNESS 0.6-6.75
(RECOMMEND FOR
REFERENCE ONLY)

Part No.	Package
CCML-1	1000

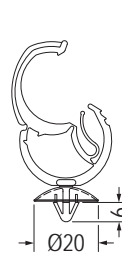

MOUNTING HOLE $\varnothing 6.2-\varnothing 6.7$
THICKNESS 0.5-2.0

Part No.	Package
CCMI-1	1000

電線固定座 CABLE CLAMP

用途：固定電線於PC板或機板上，維修方便，不佔空間。

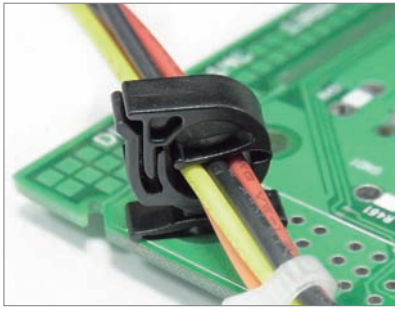

- Material: Nylon 66 (UL)
- Flame Class: 94V-2/94V-0
- Color: Natural/Black
- Unit: mm

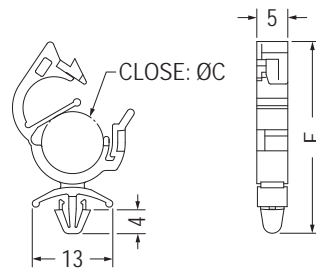

MOUNTING HOLE $\varnothing 4.0$
THICKNESS 0.8-1.6

Part No.	C	E	Package
CHN-7.6	7.6	26.7	500
CHN-10	10.0	31.0	
CHN-12	12.0	34.4	

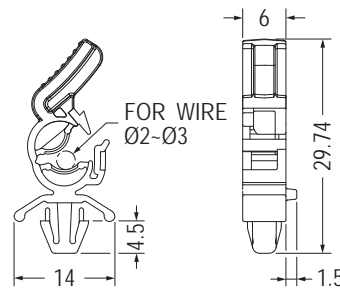
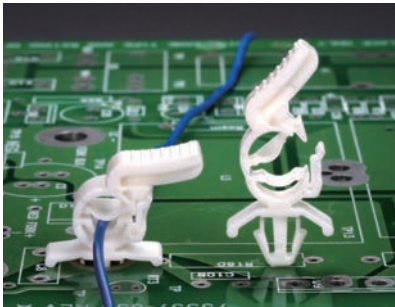

MOUNTING HOLE $\varnothing 4.8$
THICKNESS 0.5-2.0
(RECOMMEND FOR REFERENCE ONLY)

Part No.	Package
CHNA-1	1000

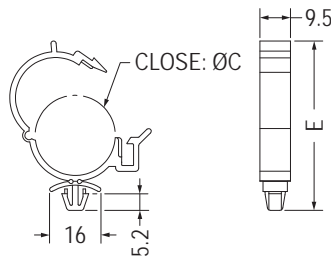
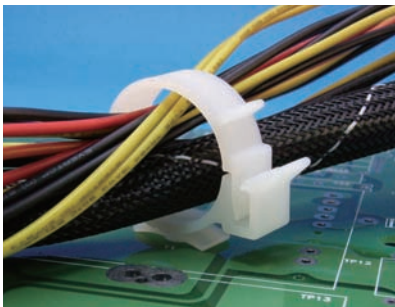

MOUNTING HOLE $\varnothing 6.5$
THICKNESS: T

Part No.	C	E	T	Package
FWT-25	25.0	52.8	0.8-1.6	100
FWT-30	30.0	59.7	0.8-2.0	

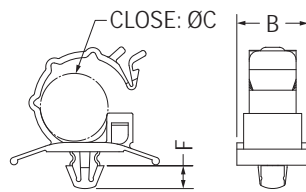
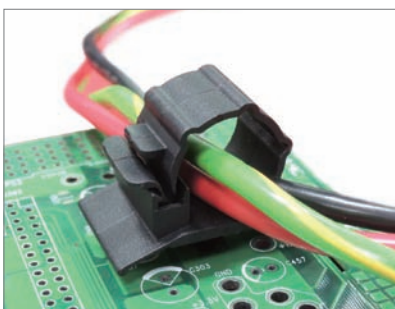

MOUNTING HOLE $\varnothing 6.4$
THICKNESS: T

Part No.	B	C	F	T	Package
CKS-7	15.0	7.0	4.9	0.8-2.3	200
CKS-10	17.2	10.3	4.9	0.8-2.3	
CKS-13-L	19.2	13.0	4.9	0.5-2.3	
CKS-14	19.3	14.8	4.9	0.8-2.3	
CKS-16-L	21.3	16.0	4.9	0.5-2.3	
CKS-20-L	23.2	20.0	4.9	0.5-2.3	
CKS-20-H	23.2	20.0	4.9	2.3-4.1	
CKS-26-L	31.4	28.0	5.0	0.5-2.3	100

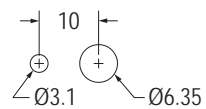
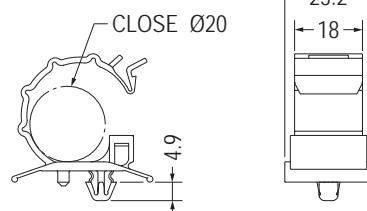
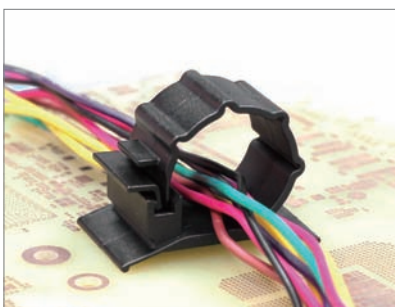

MOUNTING HOLE
THICKNESS 0.8-1.5

Part No.	Package
CKSA-20-L	200

T8燈管固定座 T8 LAMP MOUNT

用途：可固定T8 LED燈管或電線使用。



- Material: Nylon 66 (UL)
- Flame Class: 94V-2/94V-0
- Color: Natural/Black
- Unit: mm

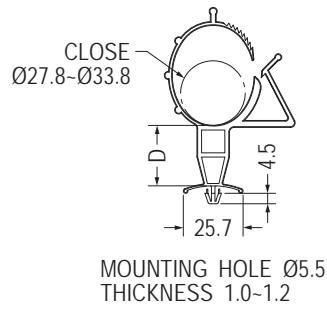

Part No.	D	Package
AWD-1	26.0	50
AWD-2	9.0	100
AWD-3	26.0	50

電線固定座 CABLE CLAMP

用途：可固定電源線，避免不小心脫落，造成電腦停機。



- Material: Nylon 66 (UL)
- Flame Class: 94V-2/94V-0
- Color: Natural/Black
- Unit: mm

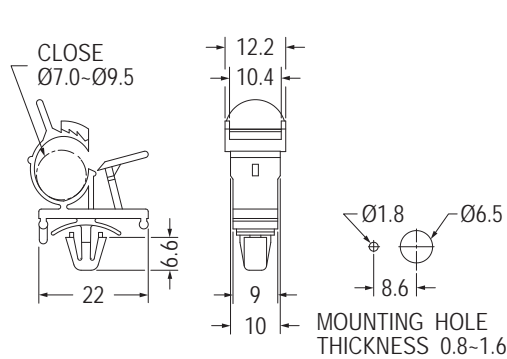

Part No.	Package
AWK-10	2000

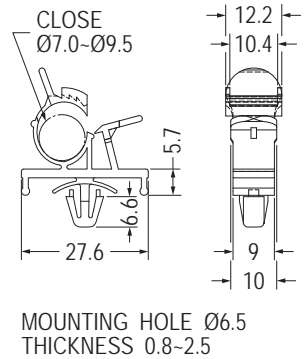

Part No.	Package
AWK-16	1000

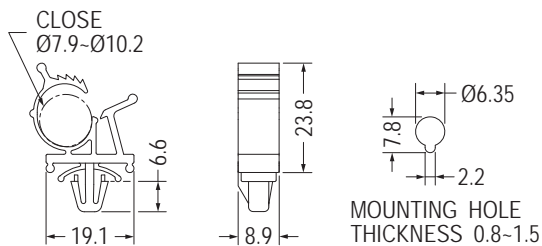

Part No.	Package
AWKA-2	500

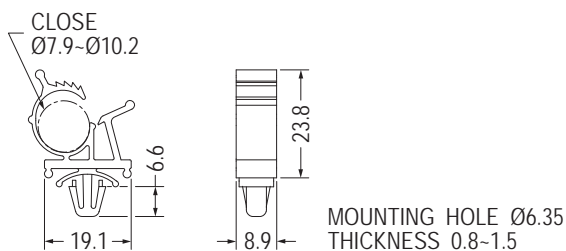
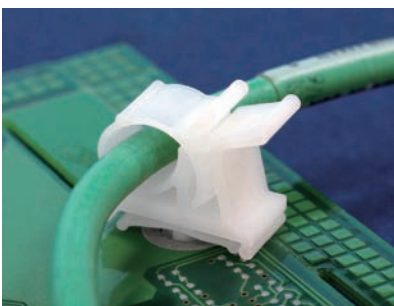

Part No.	Package
AWKA-1	500

電線固定座 CABLE CLAMP

用途：固定電線於PC板或機板上，維修方便，不佔空間。

- Material: Nylon 66 (UL)
- Flame Class: 94V-2/94V-0
- Color: Natural/Black/Gray
- Unit: mm

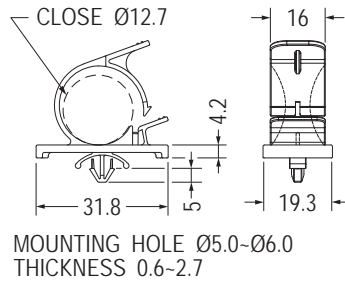

Part No.	Package
FWK-5	1000

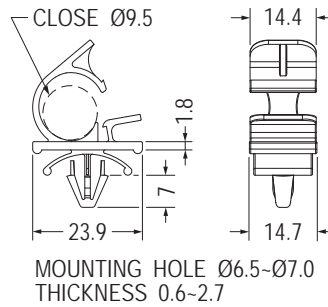
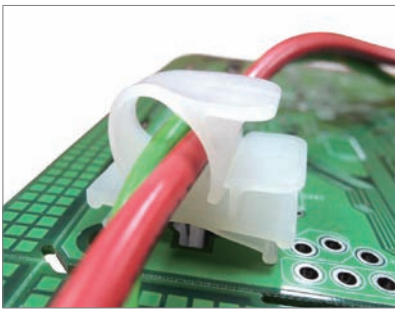

Part No.	Package
FWKA-1	250

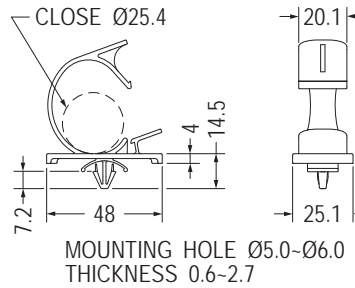
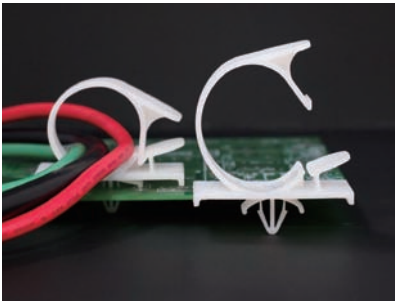

Part No.	Package
FWK-9	1000

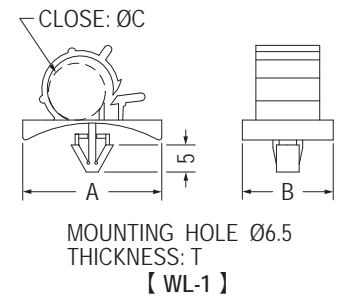
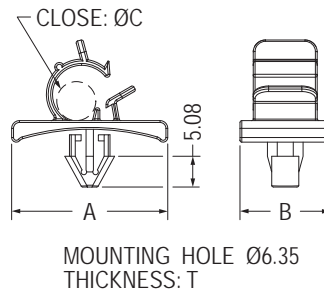

Part No.	A	B	C	T	Package
WL-1	25.7	16.8	10.5	0.8-1.6	500
WL-2	35.05	22.35	19.05	0.5-2.0	100
WL-3	25.4	14.73	6.35	2.3-3.8	500
WL-4	25.4	16.51	9.52	2.3-3.8	

電源線固定座 POWER CORD RETENER

用途：可固定電源線，避免不小心脫落，造成電腦停機。

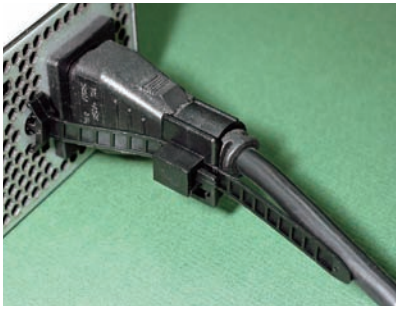

- Material: Nylon 66 (UL)
- Flame Class: 94V-2/94V-0
- Color: Black
- Unit: mm

MOUNTING HOLE: ØG
THICKNESS: T

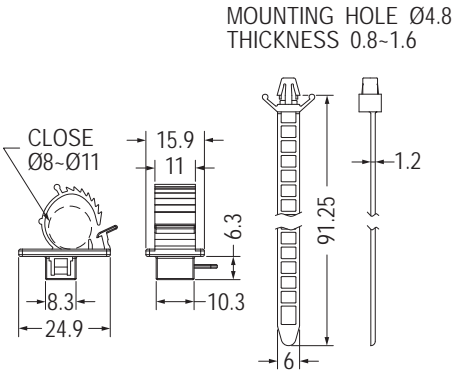

Part No.	Package
SWPL-14	100

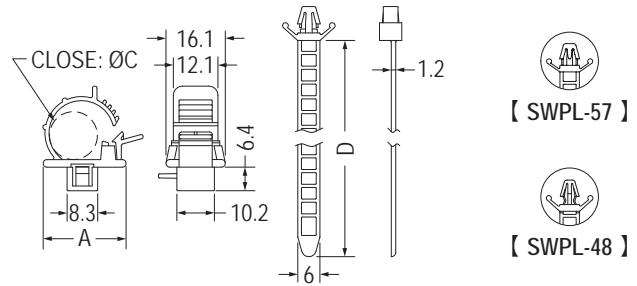

Part No.	A	C	D	G	T	Package
SWPL-1	22.5	11.0~13.0	86.75	4.8	0.8~2.0	100
SWPL-4	22.5	12.0~15.0	86.75	4.8	0.8~2.0	
SWPL-6	22.5	11.0~13.0	86.75	3.5	0.8~2.0	
SWPL-8	29.5	19.0~22.0	86.75	4.8	0.8~2.0	
SWPL-48	22.5	11.0~13.0	86.75	4.0	0.8~2.0	
SWPL-57	22.5	12.0~15.0	86.75	4.8	0.6~1.8	
SWPL-74	22.5	11.0~13.0	112.5	4.8	0.8~2.0	

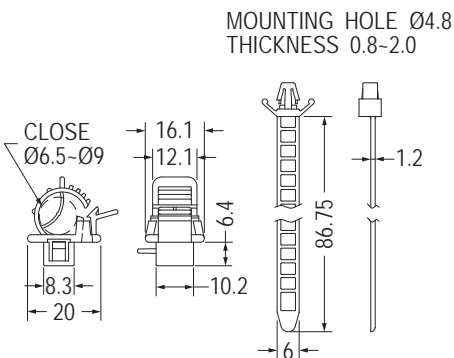

Part No.	Package
SWPL-3	100

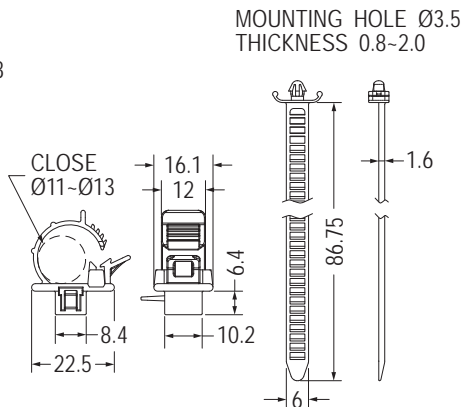

Part No.	Package
SWPL-53	100

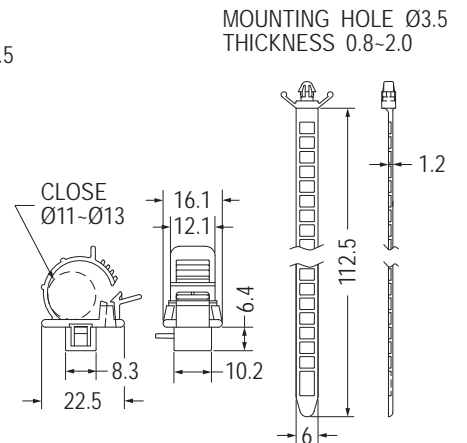

Part No.	Package
SWPL-22	100

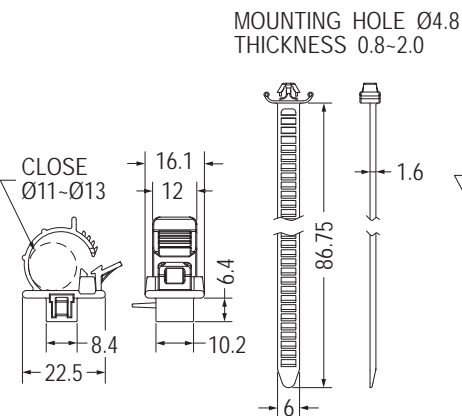

Part No.	Package
SWPL-25	100

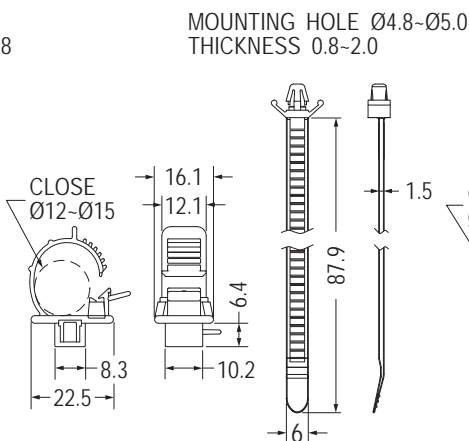

Part No.	Package
SWPL-58	100

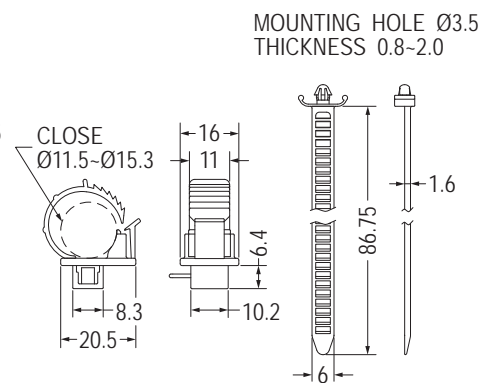

Part No.	Package
SWPL-67	100

電源線固定座 POWER CORD RETENER

用途：可固定電源線，避免不小心脫落，造成電腦停機。

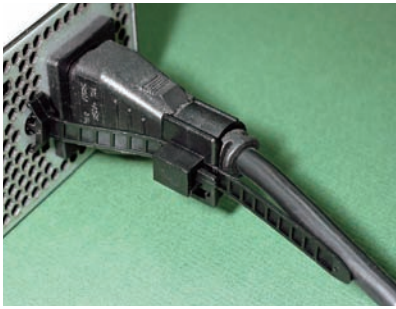

- Material: Nylon 66 (UL)
- Flame Class: 94V-2/94V-0
- Color: Black
- Unit: mm

MOUNTING HOLE Ø5.0
THICKNESS 0.5-2.0

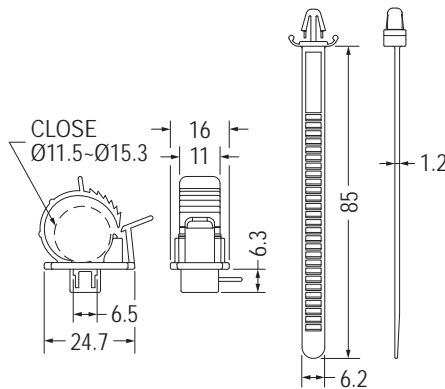

Part No.	Package
SWPL-65	100

MOUNTING HOLE THICKNESS 0.8-2.0

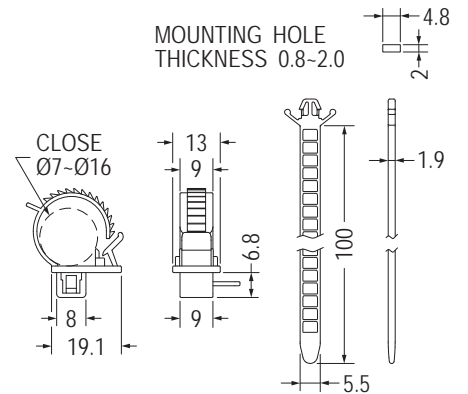

Part No.	Package
SWPL-100	100

MOUNTING HOLE THICKNESS 0.8-1.4

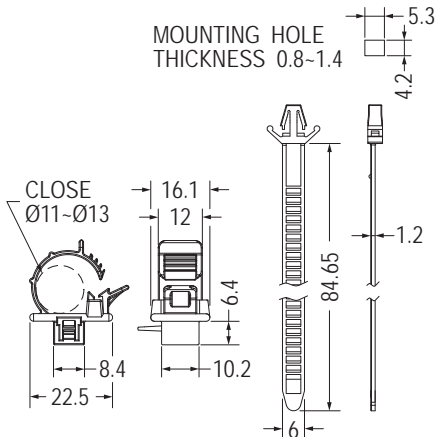

Part No.	Package
SWPL-73	100

MOUNTING HOLE THICKNESS 0.8

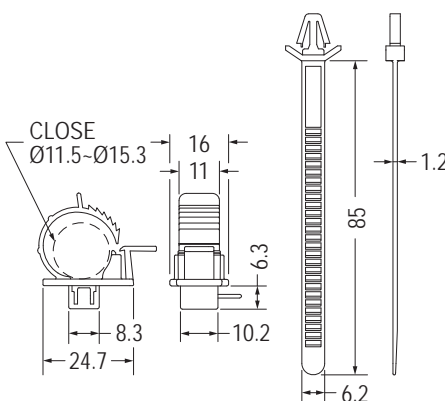

Part No.	Package
SWPL-96	100

MOUNTING HOLE: ØG
THICKNESS: T

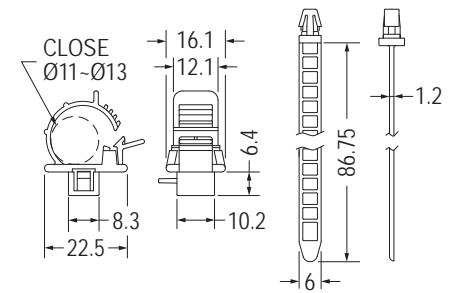

Part No.	G	T	Package
SWPL-2	4.8	2.0-3.0	100
SWPL-11	4.0	0.6-0.8	
SWPL-27	4.8	0.6-1.2	

MOUNTING HOLE Ø3.5
THICKNESS 0.8

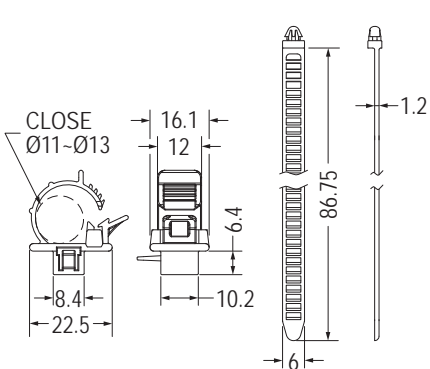

Part No.	Package
SWPL-66	100

MOUNTING HOLE Ø4.0
THICKNESS 0.6-1.0

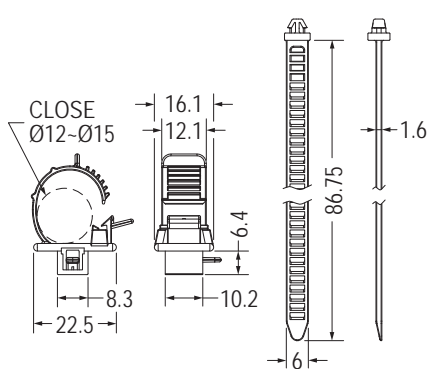

Part No.	Package
SWPL-88	100

MOUNTING HOLE Ø4.0
THICKNESS 0.6-0.8

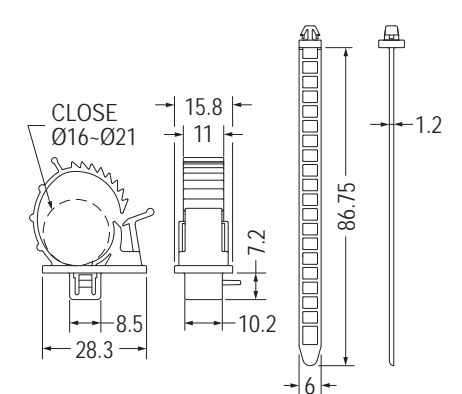

Part No.	Package
SWPL-103	100

電源線固定座 POWER CORD RETENER

用途：可固定電源線，避免不小心脫落，造成電腦停機。

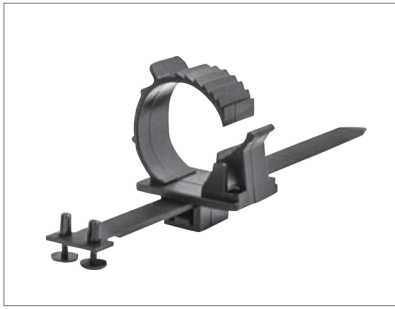

- Material: Nylon 66 (UL)
- Flame Class: 94V-2/94V-0
- Color: Black
- Unit: mm

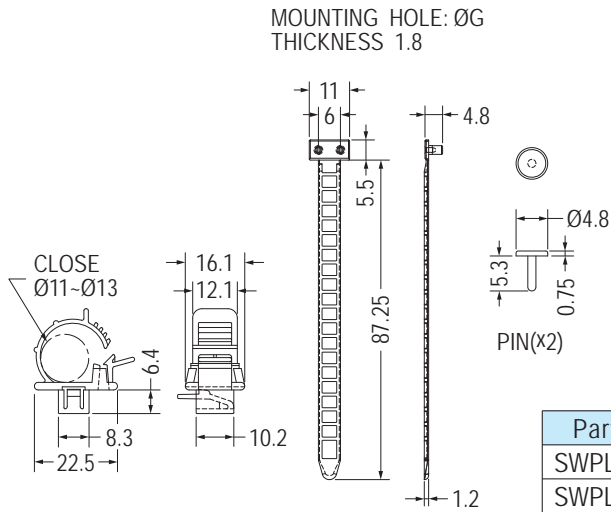

4

MOUNTING HOLE Ø3.5
THICKNESS 2.0-2.8

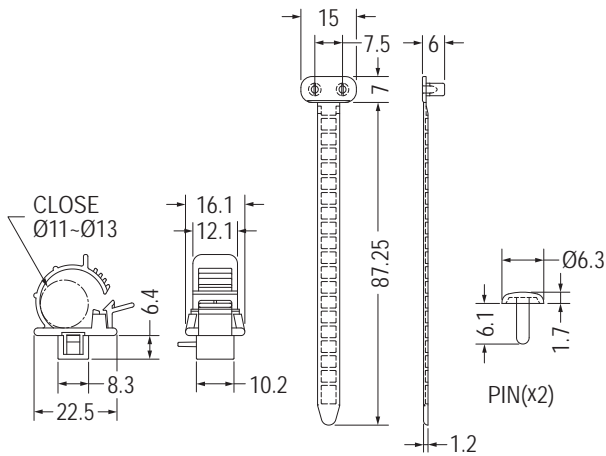

Part No.	Package
SWPL-76	100

MOUNTING HOLE Ø2.3
THICKNESS 1.8

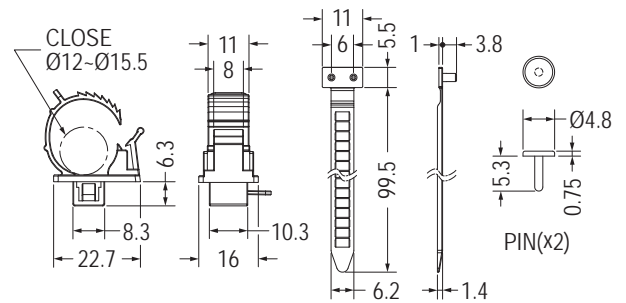

Part No.	Package
SWPL-94	100



MOUNTING HOLE Ø2.2
THICKNESS 0.8-1.0

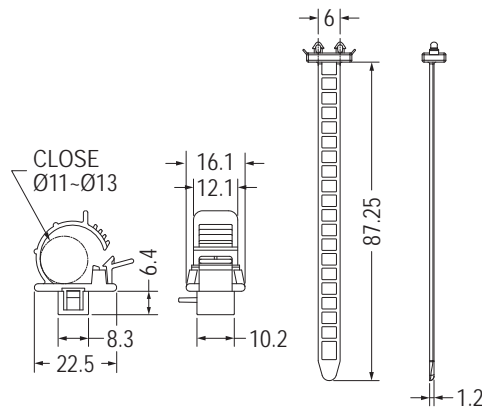

Part No.	Package
SWPL-15S	100

電源線固定座 POWER CORD RETENER

用途：可固定電源線，避免不小心脫落，造成電腦停機。

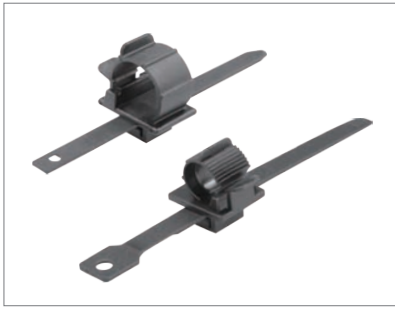

- Material: Nylon 66 (UL)
- Flame Class: 94V-2/94V-0
- Color: Black
- Unit: mm

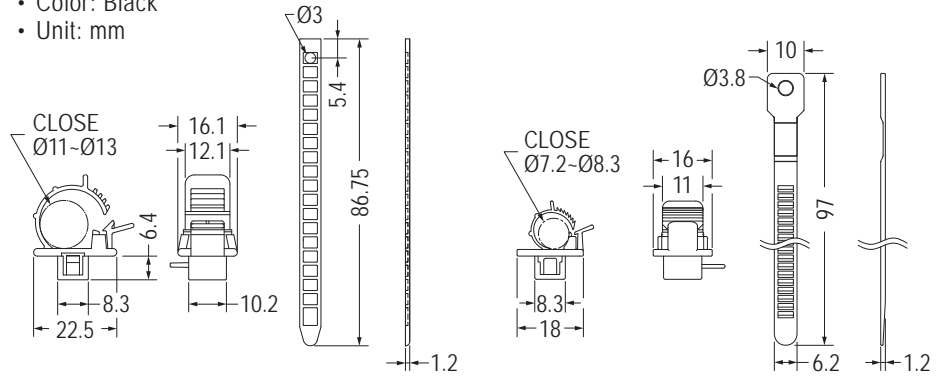

Part No.	Package
SWPL-19	100

Part No.	Package
SWPL-72	100

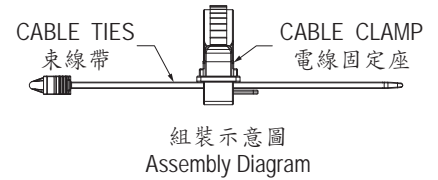
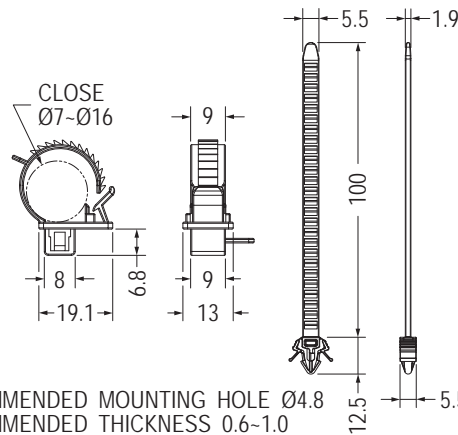
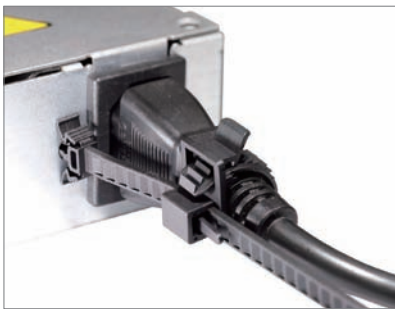

RECOMMENDED MOUNTING HOLE Ø4.8
RECOMMENDED THICKNESS 0.6-1.0

• Patented (專利品)

Part No.	Package
SWPL-106	100

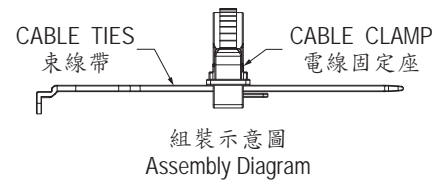
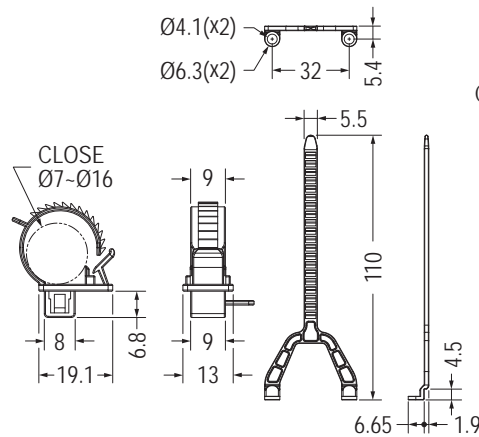
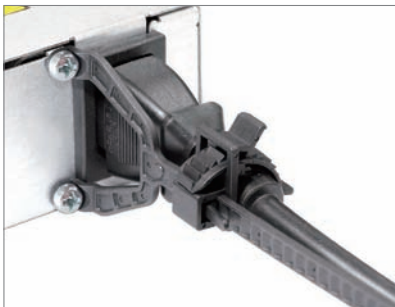

Part No.	Package
SWPL-105	100

C13 AC 電源扣件 C13 AC POWER RETAINER

用途：可固定電源線，避免不小心脫落，造成電腦停機。



- Material: Nylon 66 (UL)
- Flame Class: 94V-2/94V-0
- Color: Gary
- Unit: mm

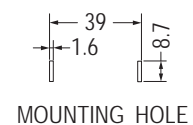
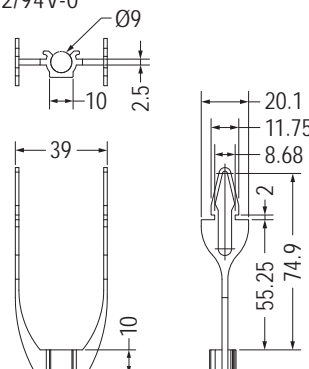

Part No.	Package
EMD-512	250

電源線固定座 POWER CORD RETENER

用途：可固定電源線，避免不小心脫落，造成電腦停機。

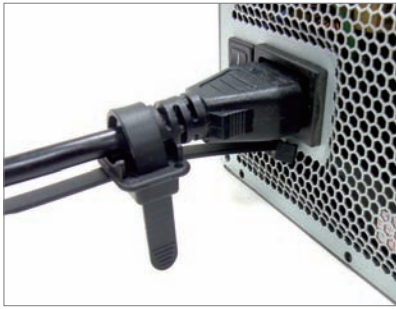

- Material: Nylon 66 (UL)
- Flame Class: 94V-2/94V-0
- Color: Black
- Unit: mm

MOUNTING HOLE Ø4.8
THICKNESS 0.8-2.0
CABLE Ø18.0
(DATA ONLY FOR REF.)

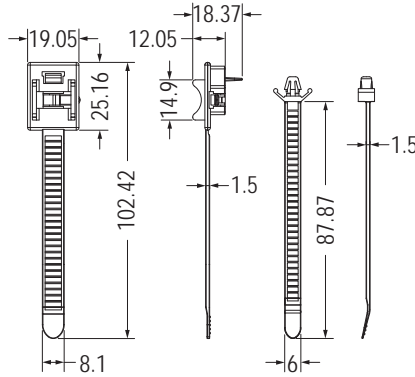

Part No.	Package
SWPL-16	500

MOUNTING HOLE Ø4.8
THICKNESS 0.8-2.0
CABLE Ø16.0
(DATA ONLY FOR REF.)

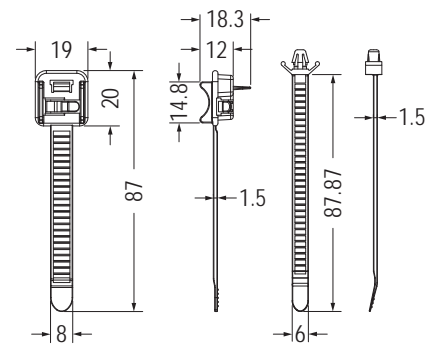

Part No.	Package
SWPL-21	500

4

MOUNTING HOLE Ø4.8
THICKNESS 0.8-2.0

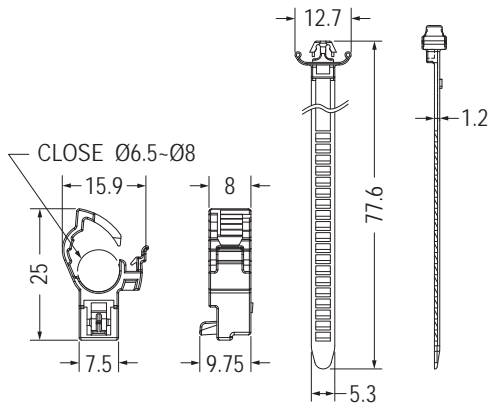

Part No.	Package
SWPL-18	100

MOUNTING HOLE Ø4.8
THICKNESS 0.8-2.0

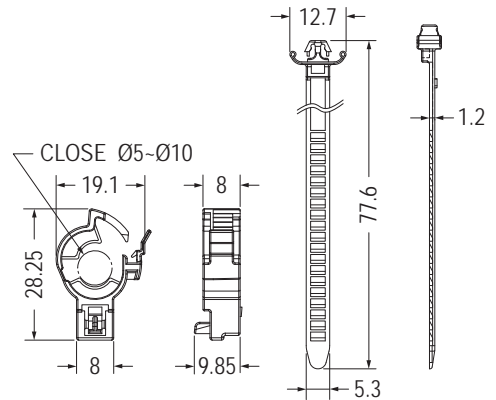

Part No.	Package
SWPL-20	100

• Patented (專利品)

MOUNTING HOLE
THICKNESS 1.8-2.8

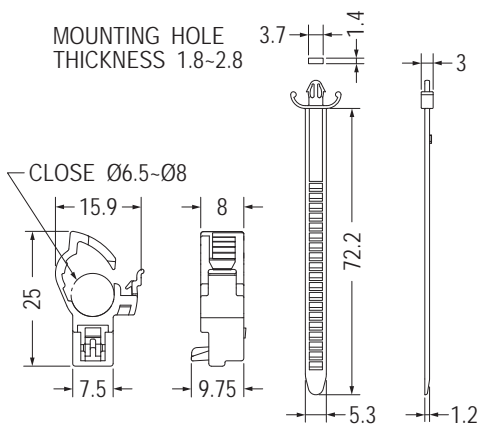

Part No.	Package
SWPL-69	100

MOUNTING HOLE Ø4.8
THICKNESS 0.8-2.0

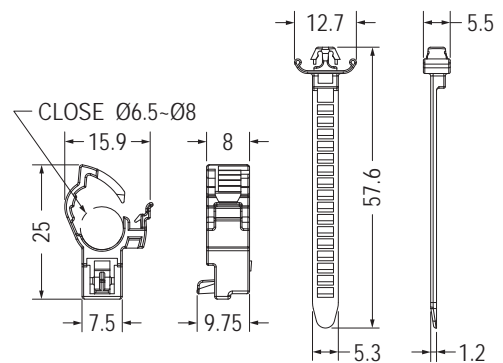

Part No.	Package
SWPL-82	500

電源線固定座 POWER CORD RETENER

用途：可固定電源線，避免不小心脫落，造成電腦停機。



- Material: Nylon 66 (UL)
- Flame Class: 94V-2/94V-0
- Color: Black
- Unit: mm

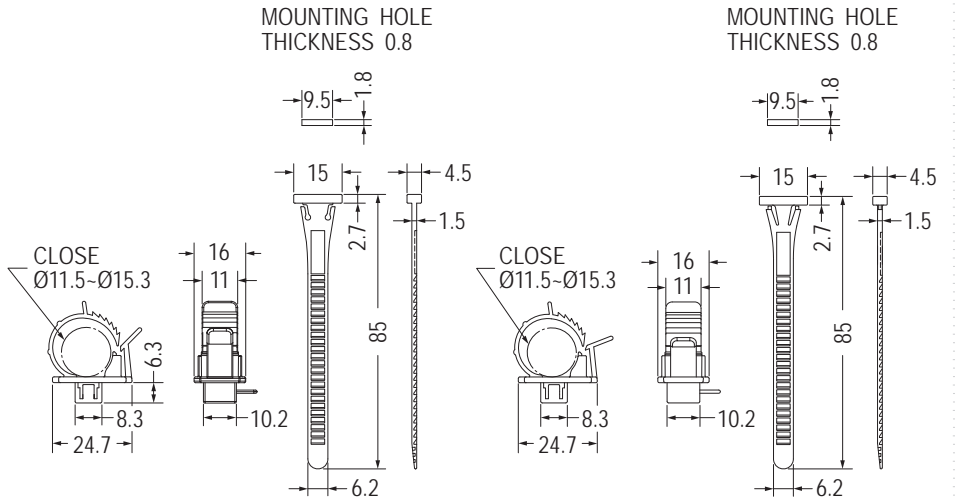

Part No.	Package
SWPL-23	100

Part No.	Package
SWPL-64	100

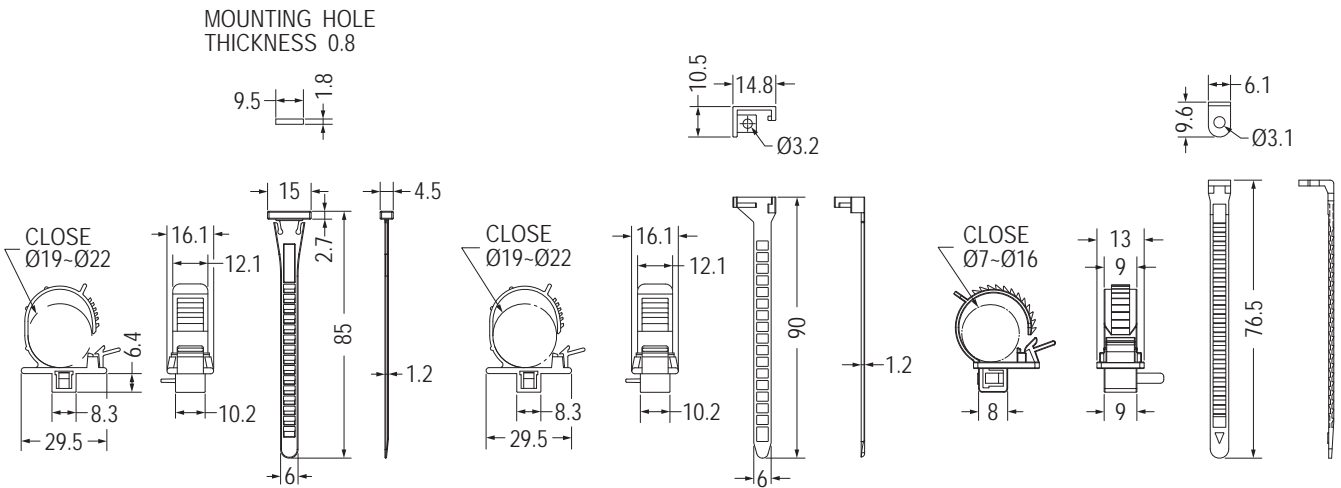

Part No.	Package
SWPL-101	100

Part No.	Package
SWPL-43	100

Part No.	Package
SWPL-78	100

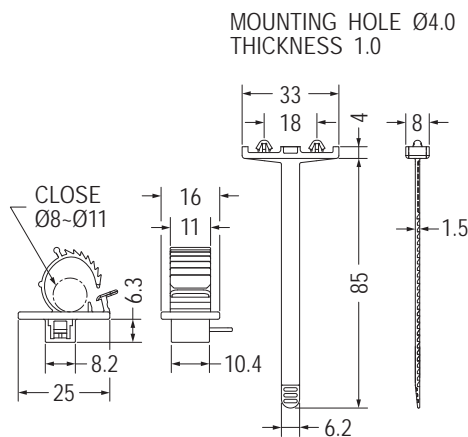

Part No.	Package
SWPL-46	100

電源線固定座 POWER CORD RETENER

用途：可固定電源線，避免不小心脫落，造成電腦停機。



- Material: Nylon 66 (UL)
- Flame Class: 94V-2/94V-0
- Color: Black
- Unit: mm

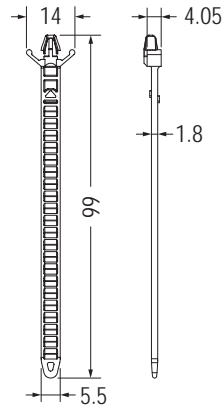
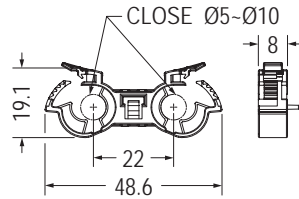

MOUNTING HOLE Ø4.0
THICKNESS 0.8-2.0

Part No.	Package
SWPL-87	100

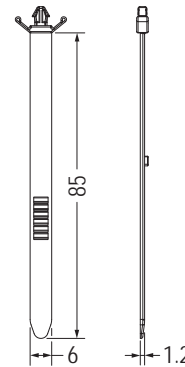
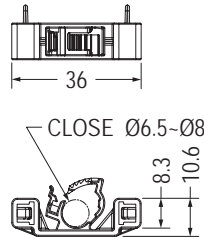

Ø3.5
MOUNTING HOLE
THICKNESS 0.8-2.0

• Patented (專利品)

Part No.	Package
SWPL-50	100

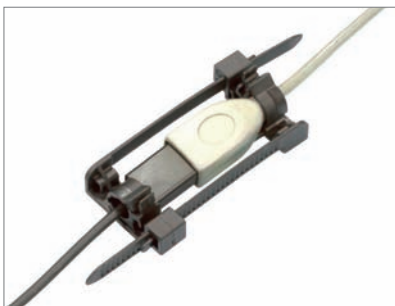

- Material: Nylon 66 (UL)
- Flame Class: 94V-2/94V-0
- Color: Black
- Unit: mm
- Patented (專利品)

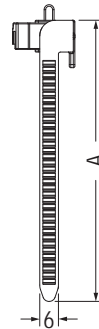
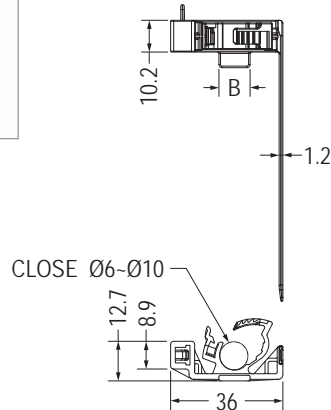

用途：固定電源線、USB...等，中間對接延長，避免脫落。

Part No.	A	B	Package
SWPL-52	90.2	10.0	100
SWPL-55	90.2		
SWPL-59	115.2	10.0	

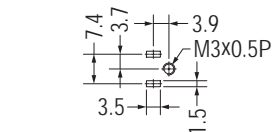
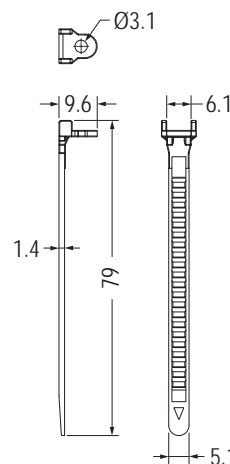
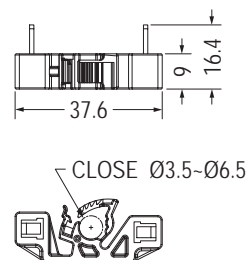

RECOMMEND MOUNTING LAYOUT

Part No.	Package
SWPL-98	100

電線插座固定座 POWER CORD RETENER

用途：避免電源插座脫落。

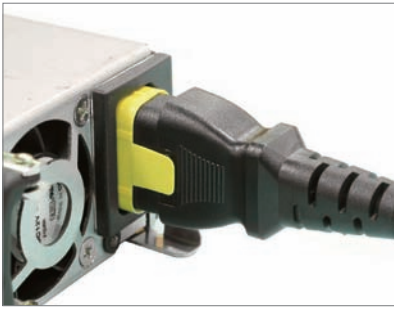

- Material: Nylon 66 (UL)
- Flame Class: 94V-2/94V-0
- Color: Natural/Black/Red/Blue/Yellow/Green
- Unit: mm

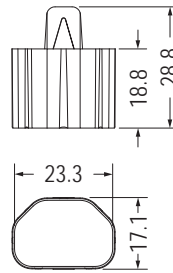

Part No.	Package
SWKL-1	1000

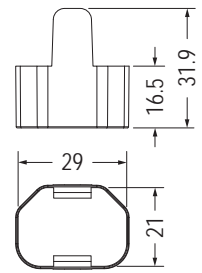

Part No.	Package
SWKL-2	1000

HDMI固定座 HDMI MOUNT

用途：配合螺絲、束線帶，使用於USB、HDMI等線材端子，固定於機殼上，避免勾到脫落。



- Material: Nylon 66 (UL)
- Flame Class: 94V-2/94V-0
- Color: Natural/Black
- Unit: mm

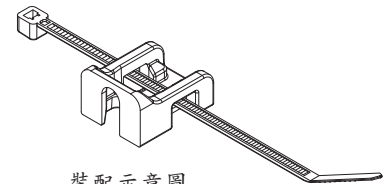
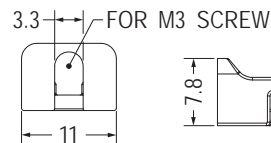
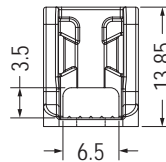

裝配示意圖
Assembly Diagram

Part No.	Package
SWCM-1	1000

束線帶固定座 CABLE TIE MOUNT

用途：固定於機板上，配合束線帶使用，固定電線。

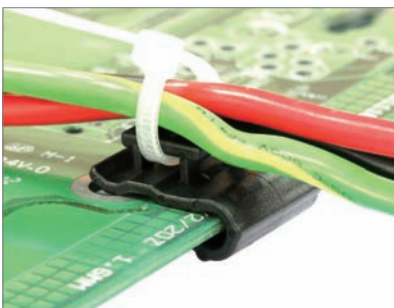

- Material: Nylon 66 (UL)
- Flame Class: 94V-2/94V-0
- Color: Natural/Black/Gray
- Unit: mm

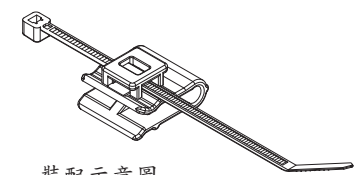
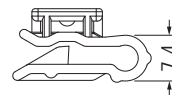
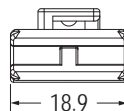
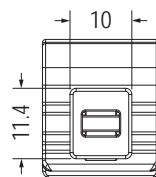

裝配示意圖
Assembly Diagram

Part No.	Package
SWPC-1	500

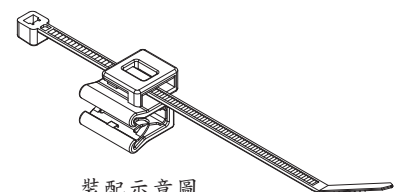
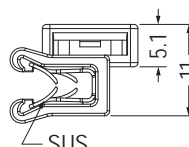
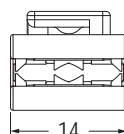
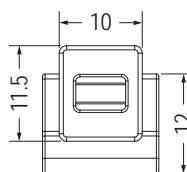
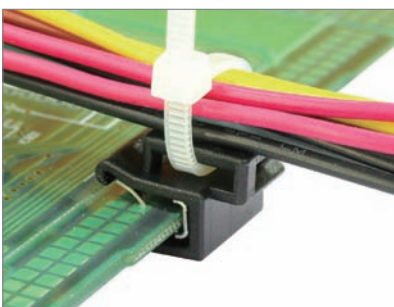

裝配示意圖
Assembly Diagram

Part No.	Package
SWPC-2	1000

RECOMMEND SUITABLE THICKNESS 1.5~2.0

電線固定座 U-CLAMP

用途：配合螺絲，固定電線，整齊美觀。

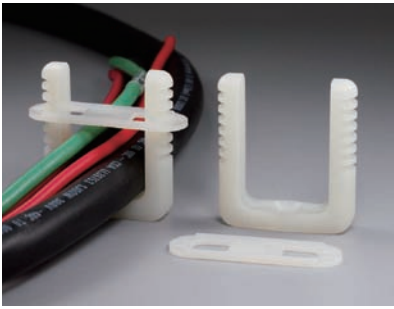

- Material: Nylon 66 (UL)
- Flame Class: 94V-2/94V-0
- Color: Natural/Black
- Unit: mm
- Patented (專利品)

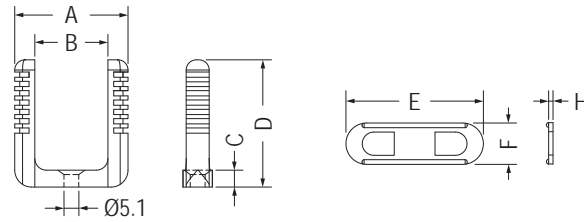

Part No.	A	B	C	D	E	F	H	Package
DC-1	38.9	25.1	5.8	43.7	47.2	14.2	1.5	100
DC-1.5	55.2	37.0	7.9	56.6	62.7	17.8	1.2	

電線固定座 WIRE SADDLE

用途：固定電線於機板上，維修方便，不佔空間。



- Material: Nylon 66 (UL)
- Flame Class: 94V-2/94V-0
- Color: Natural/Black
- Unit: mm

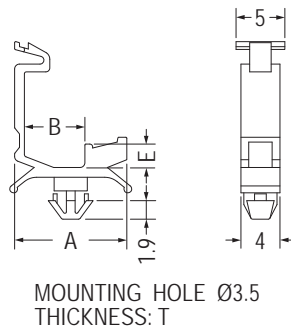

Part No.	A	B	E	T	Package
CHI-3	11.5	6.2	2.4	0.8-2.2	1000
CHI-6	16.5	11.0	4.5	0.5-1.8	

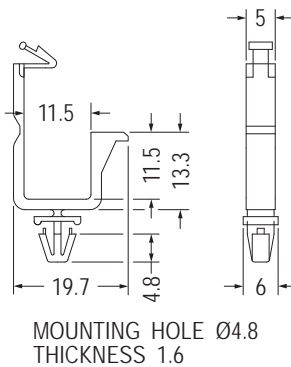
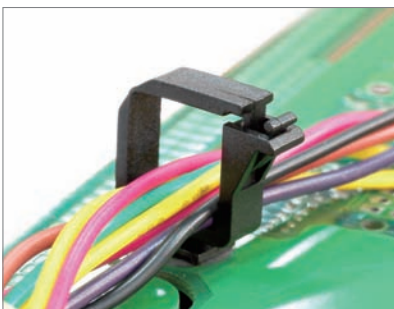

MOUNTING HOLE Ø4.8
THICKNESS 1.6

Part No.	Package
CHK-13	500

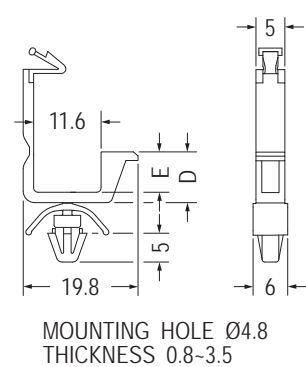

MOUNTING HOLE Ø4.8
THICKNESS 0.8-3.5

Part No.	D	E	Package
CHK-6	7.0	5.2	1000
CHK-8	8.8	7.0	
CHK-12	14.2	12.4	500

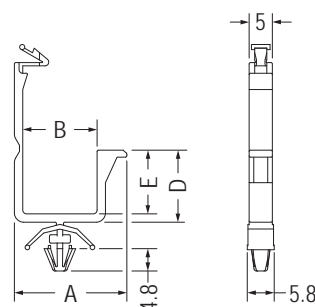

MOUNTING HOLE Ø4.8
THICKNESS 2.0-3.0

Part No.	A	B	D	E	Package
CHK-14	24.2	16.0	15.5	13.7	500
CHK-15	26.7	18.5	24.1	22.3	

電線固定座 WIRE SADDLE

用途：固定電線於機板上，維修方便，不佔空間。

- Material: Nylon 66 (UL)
- Flame Class: 94V-2/94V-0
- Color: Natural/Black
- Unit: mm

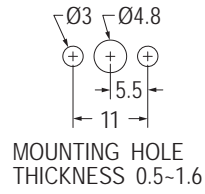
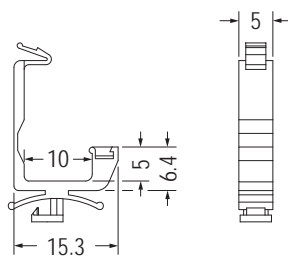
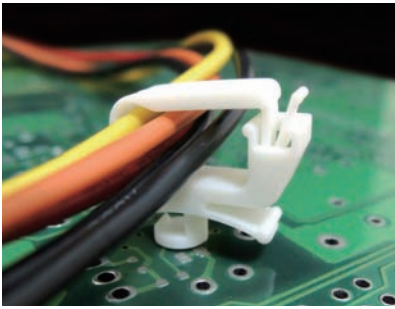

Part No.	Package
CHWA-2	500

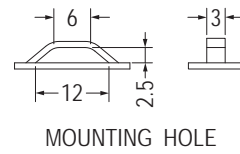
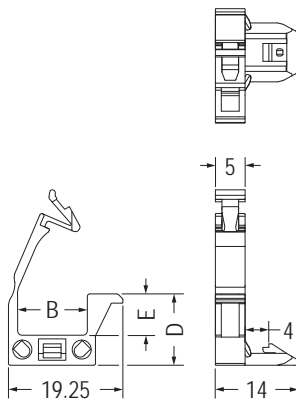
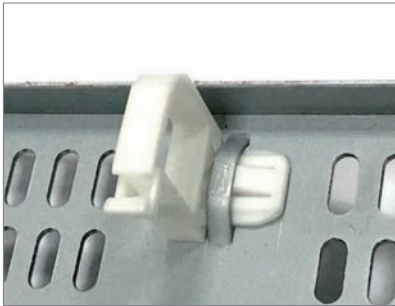

Part No.	B	D	E	Package
CHCK-1	11.62	12.0	6.95	500
CHCK-2	11.7	17.7	12.65	

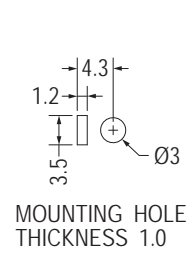
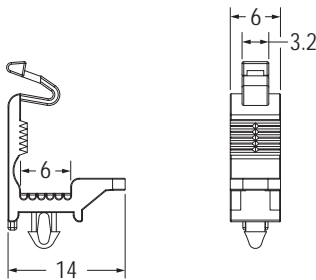
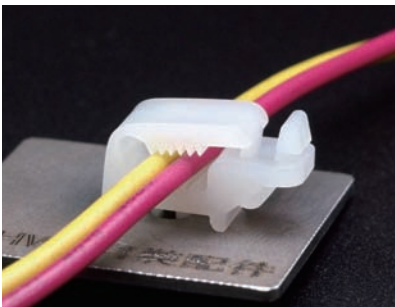

Part No.	Package
CHWF-1	1000

電線固定座 WIRE SADDLE

用途：固定電線於PC板或機板上，維修方便，不佔空間。

- Material: Nylon 66 (UL)
- Flame Class: 94V-2/94V-0
- Color: Natural/Black
- Unit: mm

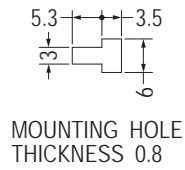
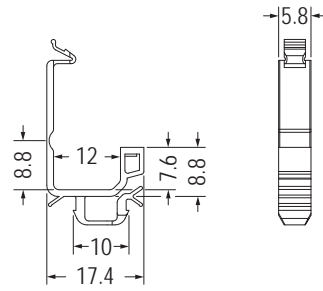

MOUNTING HOLE THICKNESS 0.8

Part No.	Package
CHWK-1	500

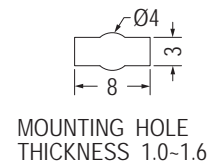
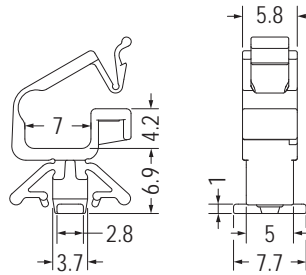

MOUNTING HOLE THICKNESS 1.0-1.6

Part No.	Package
CHKE-1	1000

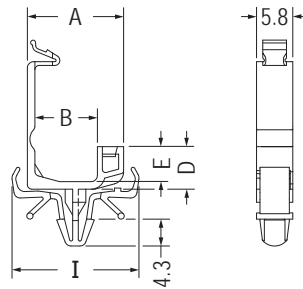

MOUNTING HOLE Ø4.8 THICKNESS 0.8-2.3

Part No.	A	B	D	E	I	Package
CHWS-6	15.4	10.0	6.8	5.6	20.31	1000
CHWS-8.5	16.4	11.0	9.3	8.1	21.31	
CHWS-12	18.3	12.0	13.3	11.6	20.31	
CHWS-14	21.4	16.0	14.8	13.6	23.31	500
CHWS-20	25.4	20.0	20.8	19.6	27.31	
CHWS-30	31.4	25.6	30.8	29.4	33.31	250

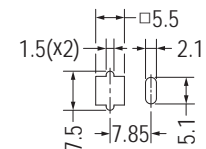
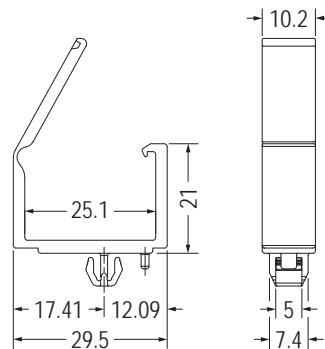

MOUNTING HOLE THICKNESS 1.2



Part No.	Package
CHAJ-2	500

電線固定座 WIRE SADDLE

用途：固定電線於PC板或機板上，維修方便，不佔空間。

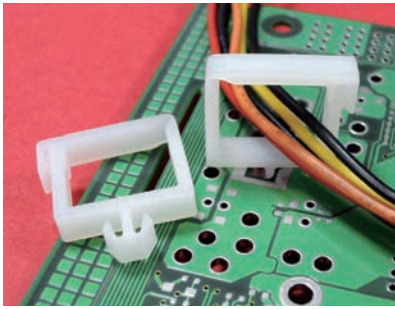

- Material: Nylon 66 (UL)
- Flame Class: 94V-2/94V-0
- Color: Natural/Black
- Unit: mm

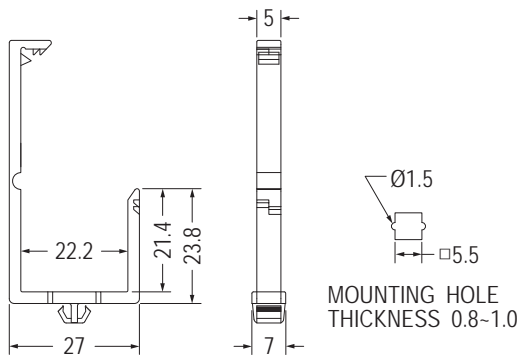

Part No.	Package
CHAC-4	500

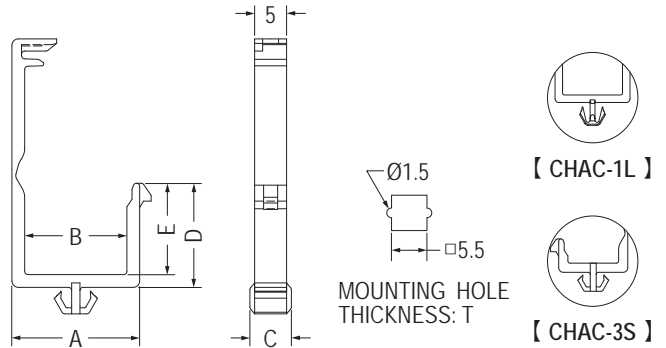

Part No.	A	B	C	D	E	T	Package
CHAC-1	20.0	16.0	6.8	16.3	14.3	1.0	1000
CHAC-1L	20.0	16.0	6.7	16.3	14.3	2.0	
CHAC-2	15.1	11.1	6.8	12.5	10.5	1.0	
CHAC-3	15.1	11.1	6.8	7.3	5.3	1.0	
CHAC-3S	15.1	11.1	6.5	7.3	5.3	1.0	

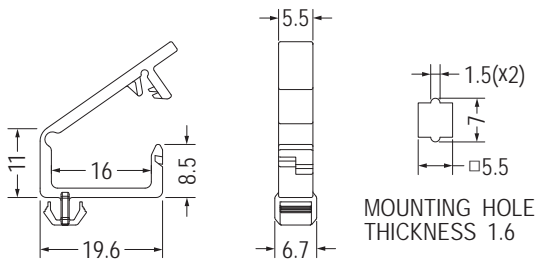

Part No.	Package
CHAC-8	1000

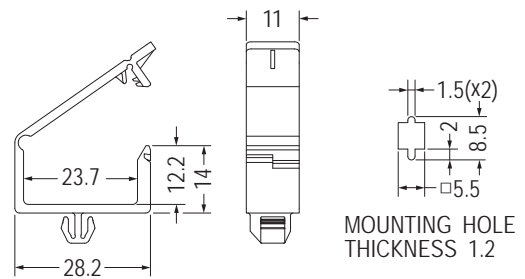

Part No.	Package
CHAC-7	1000

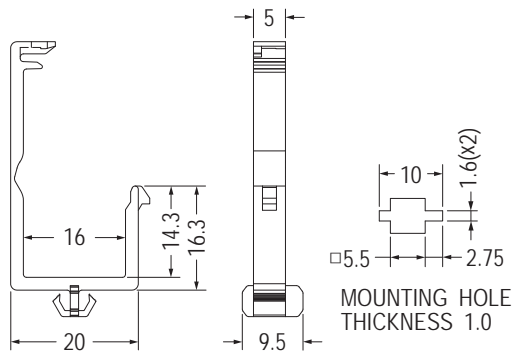

Part No.	Package
CHAC-5-1	1000

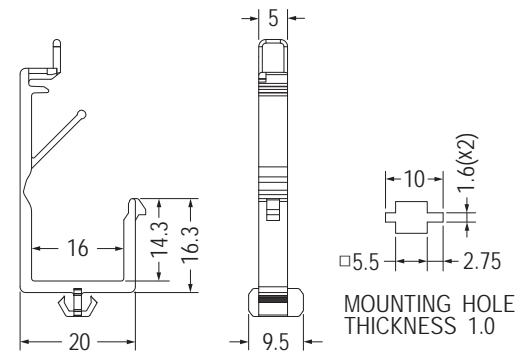

Part No.	Package
CHACA-1	1000

電線固定座 WIRE SADDLE

用途：固定電線於PC板或機板上，維修方便，不佔空間。

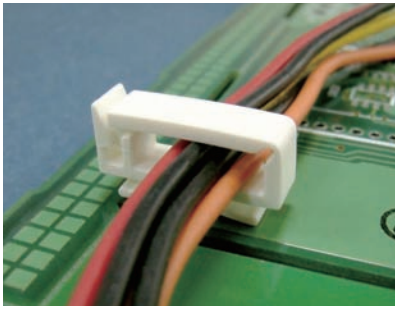

- Material: Nylon 66 (UL)
- Flame Class: 94V-2/94V-0
- Color: Natural/Black
- Unit: mm

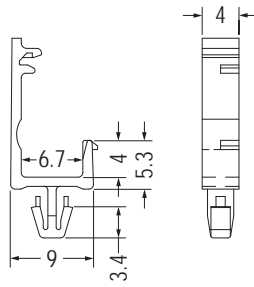

MOUNTING HOLE Ø3.0
THICKNESS 1.2-1.7

Part No.	Package
CHL-3	1000

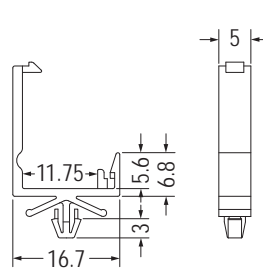

MOUNTING HOLE Ø3.5
THICKNESS 0.8-2.0

Part No.	Package
CHJ-3	1000

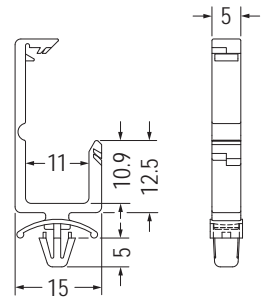

MOUNTING HOLE Ø4.8
THICKNESS 0.8-2.0

Part No.	Package
CH-1	500

4

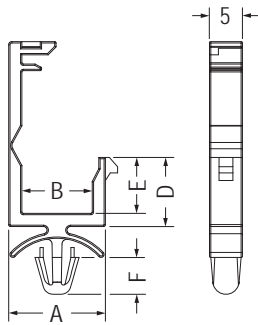

MOUNTING HOLE: ØG
THICKNESS: T

Part No.	A	B	D	E	F	G	T	Package
CHWT-3.4S	17.5	13.5	5.1	3.1	3.0	3.5	1.8	1000
CHWT-3.4	17.5	13.5	5.1	3.1	5.6	4.8	2.0	
CHWT-4.8	14.7	10.7	6.5	4.5	5.6	4.8	2.0	
CHWT-8.8	14.7	10.7	10.5	8.5	5.6	4.8	2.0	500
CHWT-10	20.3	16.3	11.7	9.7	5.6	4.8	2.0	
CHWT-14.1	20.3	16.3	15.8	13.8	5.6	4.8	2.0	
CHWT-21.7	22.0	18.0	23.4	21.4	5.6	4.8	2.0	

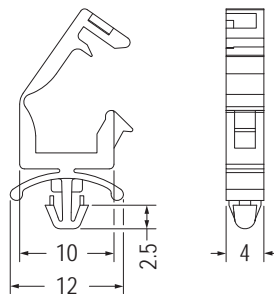
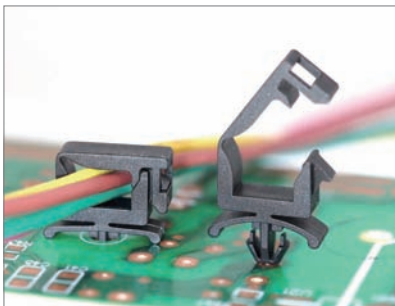

MOUNTING HOLE Ø3.5
THICKNESS 0.8-2.5

Part No.	Package
CHWH-4.4	500

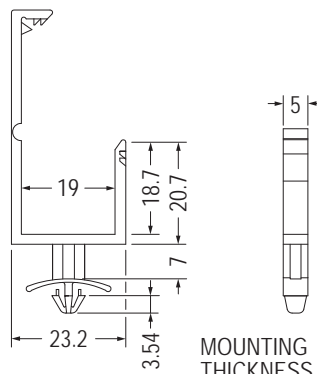
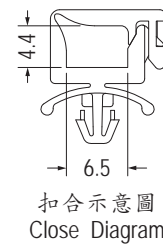

MOUNTING HOLE Ø4.8
THICKNESS 0.8-1.6

Part No.	Package
CHH-3	500

電線固定座 WIRE SADDLE

用途：固定電線於PC板或機板上，維修方便，不佔空間。

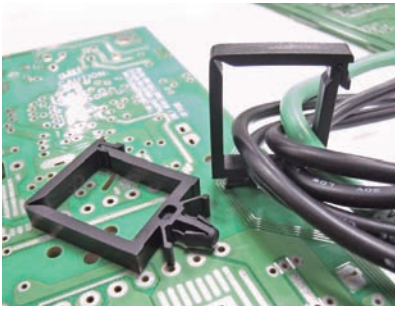

- Material: Nylon 66 (UL)
- Flame Class: 94V-2/94V-0
- Color: Natural/Black
- Unit: mm

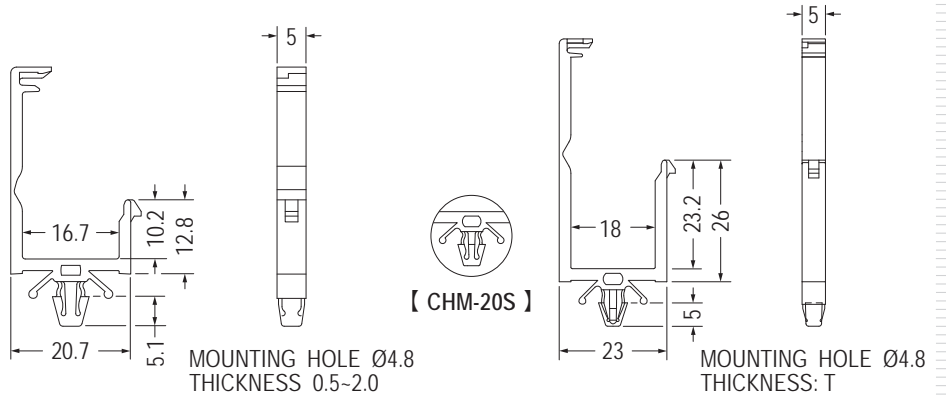

Part No.	Package
CHM-10	1000

Part No.	T	Package
CHM-20	0.5~2.0	500
CHM-20S	0.8~2.0	

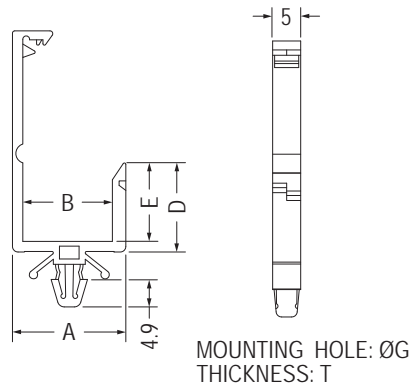
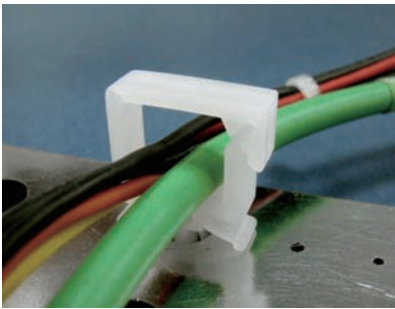

Part No.	A	B	D	E	G	T	Package	UL
CHC-1	20.25	16.0	15.9	14.0	4.8-5.0	1.2-2.4	500	UL
CHC-2	15.35	11.1	11.8	9.9	4.8-5.0	1.2-2.4		UL
CHC-3	15.35	11.1	6.8	4.9	4.8-5.0	1.2-2.4		UL
CHC-5	27.0	22.8	14.85	12.85	4.8	0.5-1.0		

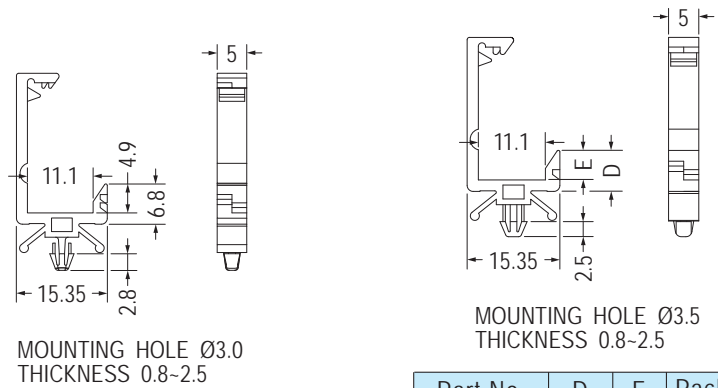
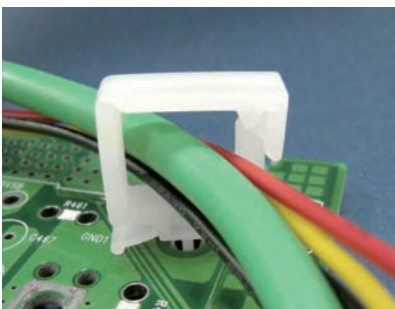

Part No.	Package
CHCS-1	500

Part No.	D	E	Package
CHH-1	6.8	4.9	500
CHH-2	11.8	9.9	

電線固定座 WIRE SADDLE

用途：固定電線於PC板或機板上，維修方便，不佔空間。



- Material: Nylon 66 (UL)
- Flame Class: 94V-2/94V-0
- Color: Natural/Black
- Unit: mm

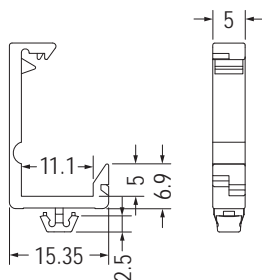

MOUNTING HOLE $\varnothing 4.8$
THICKNESS 1.0

Part No.	Package
CHC-4	500

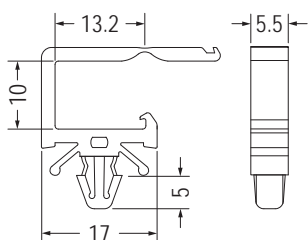

MOUNTING HOLE $\varnothing 4.8\text{-}\varnothing 5.0$
THICKNESS 1.2-2.4

Part No.	Package
CHC-6	1000

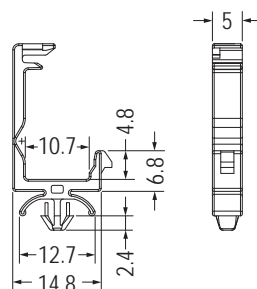

MOUNTING HOLE $\varnothing 4.0$
THICKNESS 0.8-2.5

Part No.	Package
CHZB-1	500

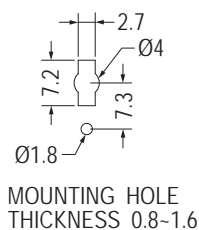
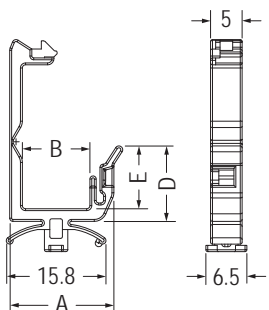

MOUNTING HOLE
THICKNESS 0.8-1.6

Part No.	A	B	D	E	Package
CHZ-1	16.5	10.7	11.95	9.95	500
CHZ-2	22.1	16.3	12.85	10.85	
CHZ-3	22.1	16.3	16.95	14.95	
CHZ-4	23.8	18.0	24.55	22.55	

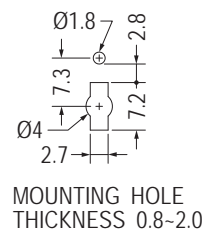
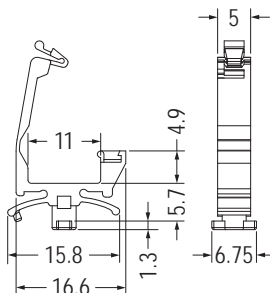

MOUNTING HOLE
THICKNESS 0.8-2.0

Part No.	Package
CHKA-1	1000

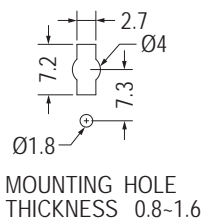
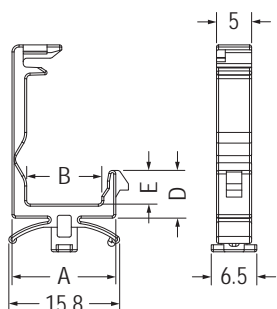

MOUNTING HOLE
THICKNESS 0.8-1.6



Part No.	A	B	D	E	Package
CHZA-1	14.8	10.7	6.8	4.8	1000
CHZA-1S	14.8	10.7	6.8	4.8	
CHZA-2	14.8	10.7	11.0	9.0	
CHZA-2S	14.8	10.7	11.0	9.0	
CHZA-3	20.4	16.3	11.9	9.9	500
CHZA-3S	20.4	16.3	11.9	9.9	
CHZA-4	20.4	16.3	16.0	14.0	
CHZA-4S	20.4	16.3	16.0	14.0	
CHZA-5	22.1	18.0	23.6	21.6	
CHZA-5S	22.1	18.0	23.6	21.6	

電線固定座 WIRE SADDLE

用途：固定電線於PC板或機板上，維修方便，不佔空間。

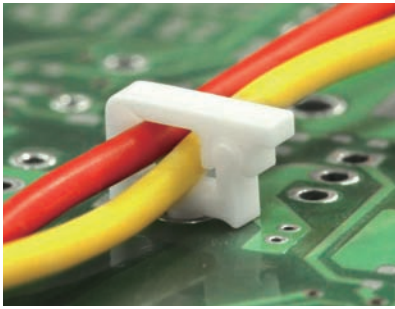

- Material: Nylon 66 (UL)
- Flame Class: 94V-2/94V-0
- Color: Natural/Black
- Unit: mm

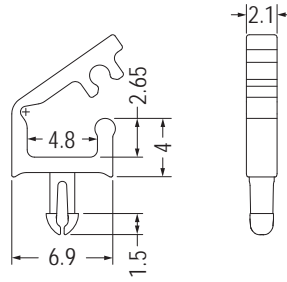

MOUNTING HOLE Ø1.7
THICKNESS 2.4

Part No.	Package
CHLB-1	1000

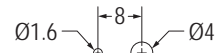
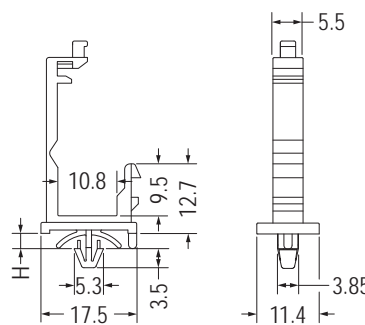
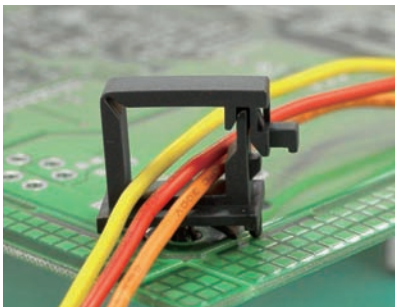

MOUNTING HOLE
THICKNESS: T

Part No.	H	T	Package
CHWE-1	2.79	1.6-2.0	1000
CHWE-1S	1.7	0.8-1.0	
CHWE-1M	2.0	0.8-1.0	

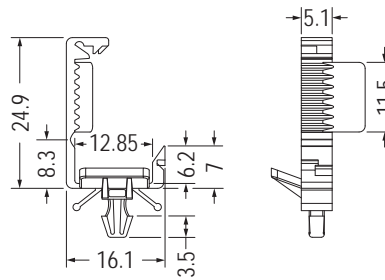
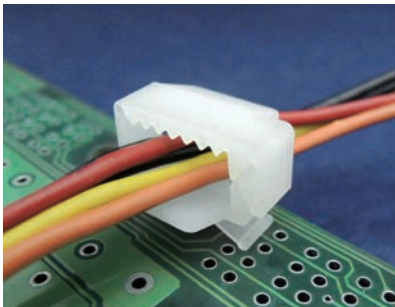

MOUNTING HOLE Ø3.5
THICKNESS 1.0-2.5

Part No.	Package
CHCA-1	500

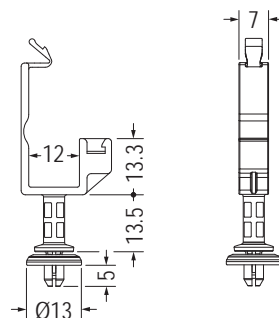

MOUNTING HOLE Ø4.6
THICKNESS 3.5

• Patented (專利品)

Part No.	Package
CHKC-1	1000

電線固定座 WIRE SADDLE

用途：固定電線於PC板或機板上，維修方便，不佔空間。



- Material: Nylon 66 (UL)
- Flame Class: 94V-2/94V-0
- Color: Natural/Black
- Unit: mm

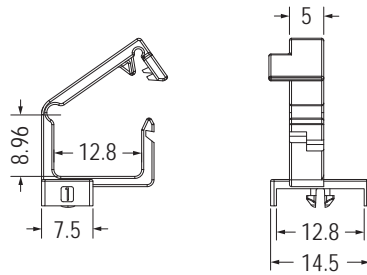

MOUNTING HOLE Ø3.0
THICKNESS 0.8

Part No.	Package
MIS-27	1000

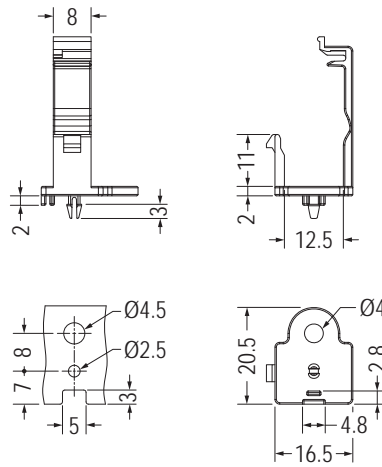

MOUNTING HOLE THICKNESS 1.6



Part No.	Package
CHMK-5	1000

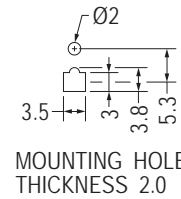
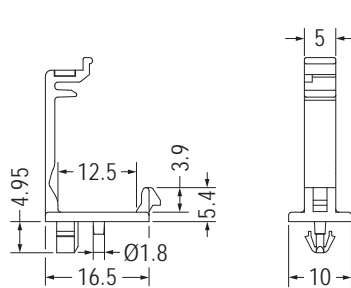
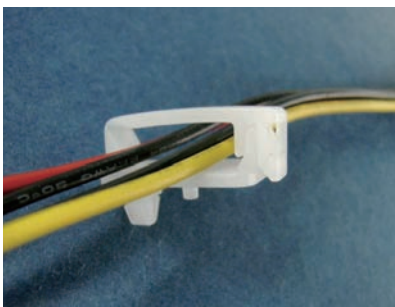

MOUNTING HOLE THICKNESS 2.0

Part No.	Package
CHMK-1	1000

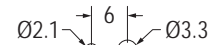
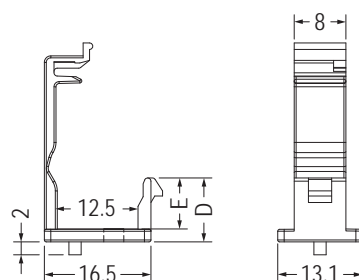
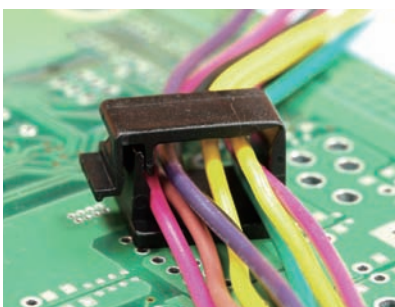

MOUNTING HOLE

Part No.	D	E	Package
CHMK-2	9.9	7.9	1000
CHMK-3	13.0	11.0	

電線固定座 WIRE SADDLE

用途：固定電線於PC板或機板上，維修方便，不佔空間。

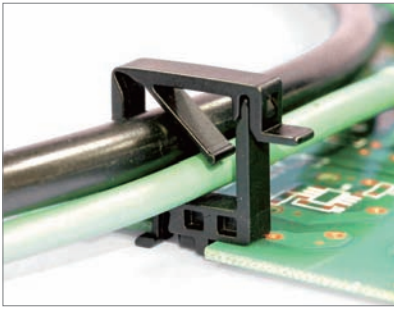

- Material: Nylon 66 (UL)
- Flame Class: 94V-2/94V-0
- Color: Natural/Black
- Unit: mm

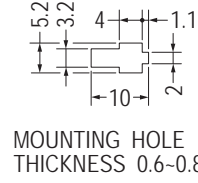
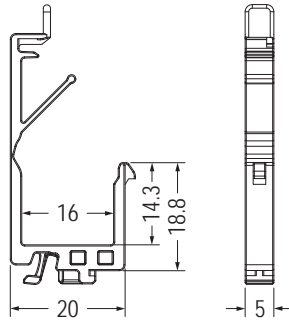

MOUNTING HOLE THICKNESS 0.6-0.8

Part No.	Package
CHACB-1	1000

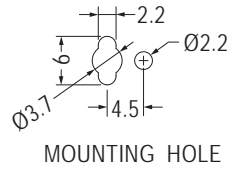
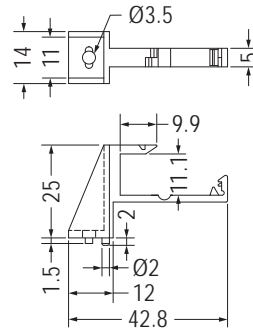
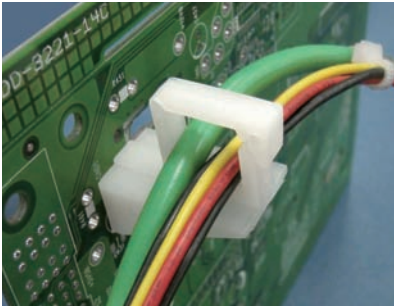

MOUNTING HOLE

Part No.	Package
CHW-1	250

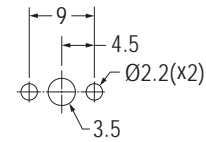
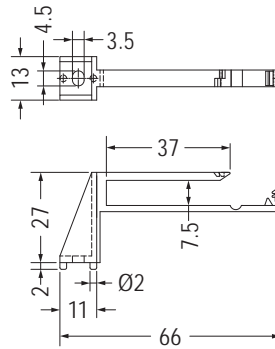

MOUNTING HOLE

Part No.	Package
CHW-2	250

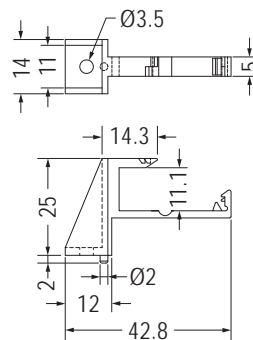

Part No.	Package
CHW-1T	250

電線固定座 WIRE HOLDER

用途：背膠式，固定電線，維修方便。

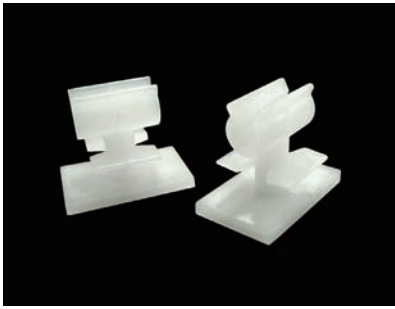

- Material: Nylon 66 (UL)
- Flame Class: 94V-2/94V-0
- Color: Natural/Black
- Unit: mm

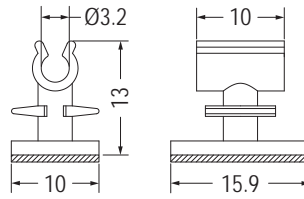

3M DOUBLE ADHESIVE TAPE

Part No.	Package
THVA-1	500

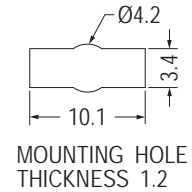
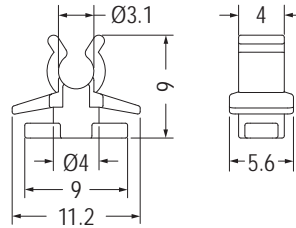

MOUNTING HOLE THICKNESS 1.2

Part No.	Package
THVB-1	500

電線固定座 WIRE MOUNT

用途：固定電線於PC板或機板上，維修方便，不佔空間。

4



- Material: Nylon 66 (UL)
- Flame Class: 94V-2/94V-0
- Color: Natural/Black
- Unit: mm

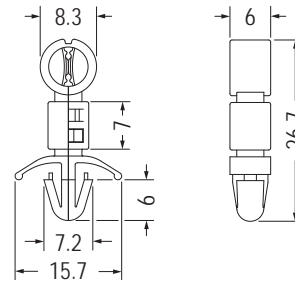

MOUNTING HOLE Ø5.5 THICKNESS 0.8-2.3

Part No.	Package
OCSH-14	500

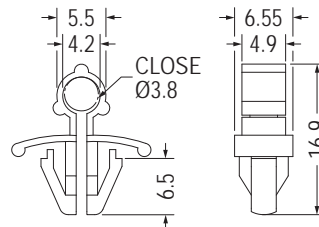

MOUNTING HOLE Ø6.5 THICKNESS 1.2

Part No.	Package
OCC-4	500

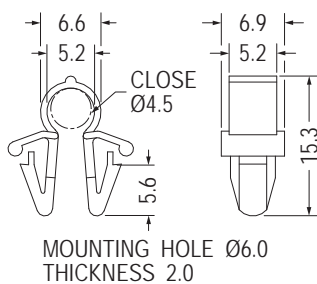

MOUNTING HOLE Ø6.0 THICKNESS 2.0

Part No.	Package
OCC-5	1000

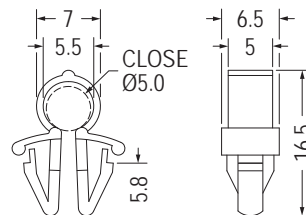

MOUNTING HOLE Ø6.5 THICKNESS 2.0

Part No.	Package
OCC6.5-5	1000

電線固定座 WIRE MOUNT

用途：固定電線於PC板或機板上，維修方便，不佔空間。

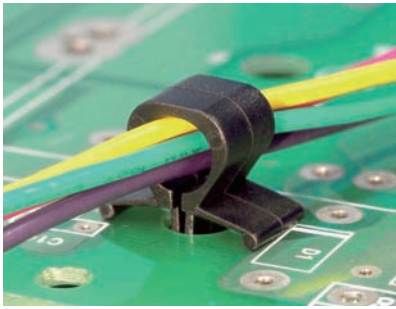

- Material: Nylon 66 (UL)
- Flame Class: 94V-2/94V-0
- Color: Natural/Black
- Unit: mm

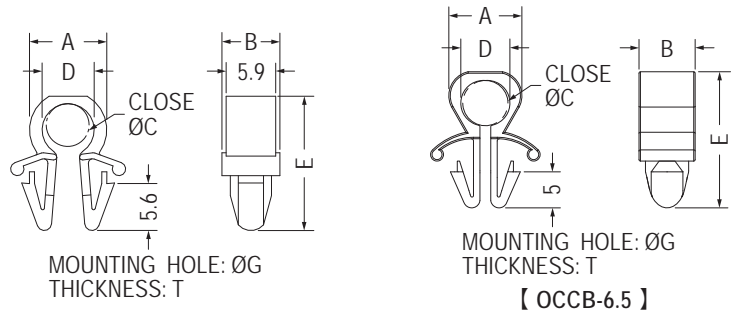

Part No.	A	B	C	D	E	G	T	Package
OCC-6	9.2	6.9	5.0	6.2	16.0	6.0	2.0	1000
OCCB-6.5	10.15	7.8	6.3	6.82	18.9	6.5	2.5-4.0	
OCC-8	11.2	6.9	7.0	8.2	17.6	6.0	2.0	500
OCC-10	13.2	6.9	9.0	10.2	20.1	6.0	2.0	

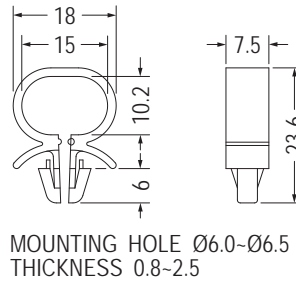

Part No.	Package
OCCB-15	500

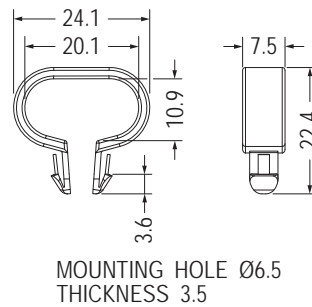

Part No.	Package
OCCB-20	500

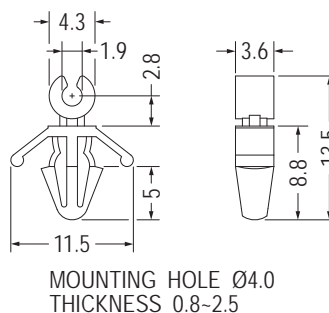
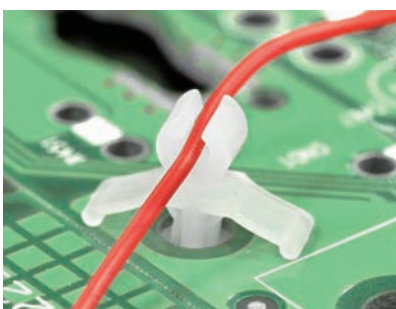

Part No.	Package
THV-11	1000

電線固定座 WIRE MOUNT

用途：固定電線於PC板或機板上，維修方便，不佔空間。

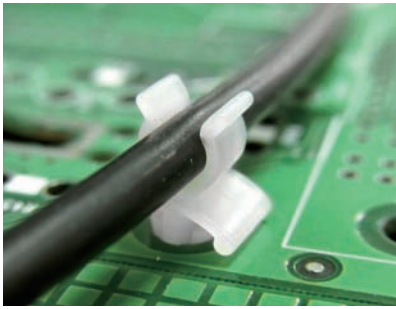

- Material: Nylon 66 (UL)
- Flame Class: 94V-2/94V-0
- Color: Natural/Black
- Unit: mm

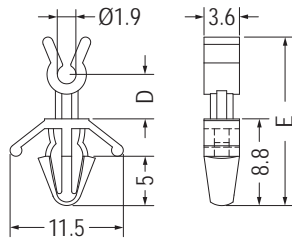

MOUNTING HOLE Ø4.0
THICKNESS 0.8-2.5

Part No.	D	E	Package
THV-1	4.5	17.1	500
THV-7	12.5	25.1	

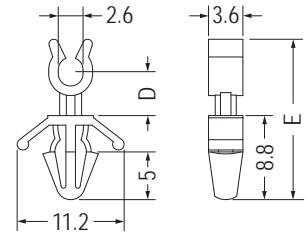

MOUNTING HOLE Ø4.0
THICKNESS 0.8-2.5

Part No.	D	E	Package
THV-3	4.6	16.8	500
THV-4	8.5	20.7	

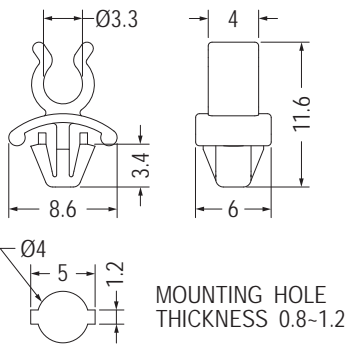

MOUNTING HOLE
THICKNESS 0.8-1.2

Part No.	Package
THV-6	1000

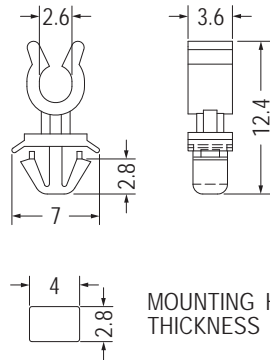

MOUNTING HOLE
THICKNESS 0.6

Part No.	Package
THV-5	500

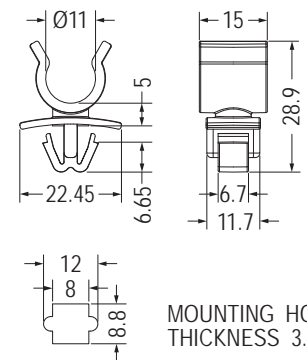

MOUNTING HOLE
THICKNESS 3.0

Part No.	Package
THV-9	1000

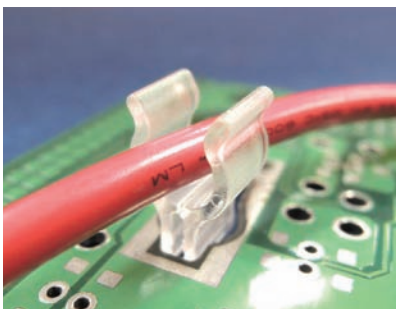

- Material: PC (UL)
- Flame Class: 94V-2
- Color: Transparent
- Unit: mm

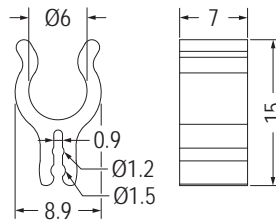

Part No.	Package
THVD-1	500

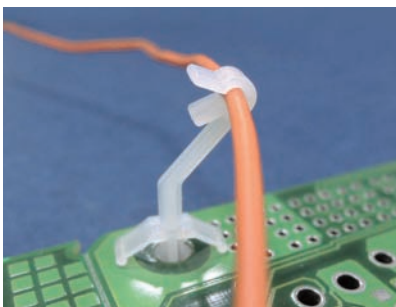

- Material: Nylon 66 (UL)
- Flame Class: 94V-2/94V-0
- Color: Natural/Black
- Unit: mm

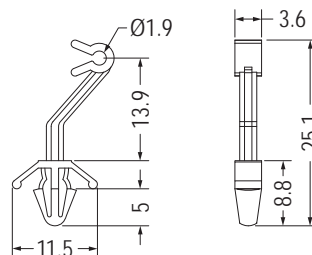

MOUNTING HOLE Ø4.0
THICKNESS 0.8-2.5

Part No.	Package
THV-8	1000

電線固定座 WIRE MOUNT

用途：固定電線於PC板或機板上，維修方便，不佔空間。

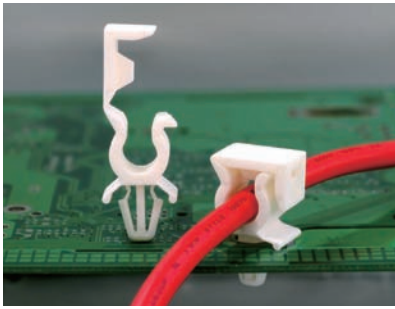

- Material: Nylon 66 (UL)
- Flame Class: 94V-2/94V-0
- Color: Natural/Black
- Unit: mm

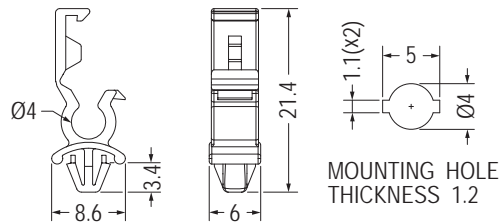

Part No.	Package
THV-14	1000

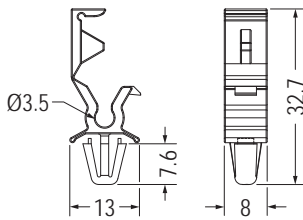

MOUNTING HOLE Ø6.0
THICKNESS 1.2

Part No.	Package
THV-17	1000

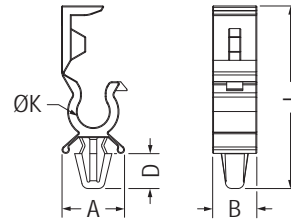

MOUNTING HOLE: ØG
THICKNESS 1.2

Part No.	A	B	D	G	K	L	Package
THV-15	13.6	9.63	7.6	6.0	7.0	39.8	1000
THV-16	11.5	3.6	5.0	4.0	1.9	21.23	

電線固定座 CABLE CLIP

用途：固定電線於PC板或機板上，維修方便，不佔空間。



- Material: Nylon 66 (UL)
- Flame Class: 94V-2/94V-0
- Color: Natural/Black
- Unit: mm

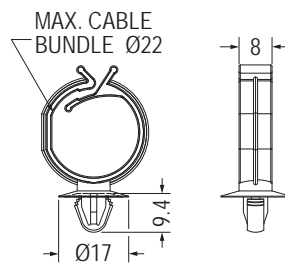

MOUNTING HOLE Ø6.5-Ø7.0
THICKNESS 0.6-2.0

Part No.	Package
THW-2	500

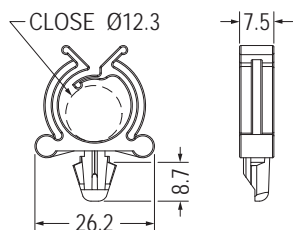

MOUNTING HOLE Ø6.35
THICKNESS 0.8-1.6

Part No.	Package
THW-1	500

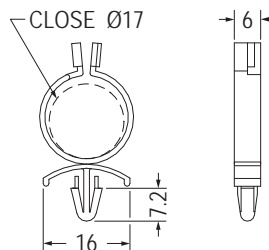

MOUNTING HOLE Ø4.8
THICKNESS 1.0-3.2

Part No.	Package
SLC-17	500

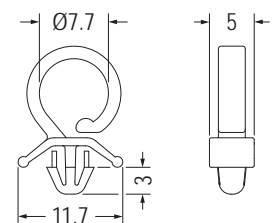

MOUNTING HOLE Ø4.0
THICKNESS 0.6-2.0

Part No.	Package
SLCB-8	1000

電線固定座 CABLE CLIP



- Material: Nylon 66 (UL)
- Flame Class: 94V-2/94V-0
- Color: Natural/Black
- Unit: mm

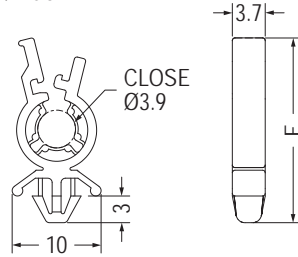

MOUNTING HOLE Ø4.0
THICKNESS 0.8-2.0

Part No.	E	Package
SLCPA-1	20.8	500
SLCPA-2	25.85	

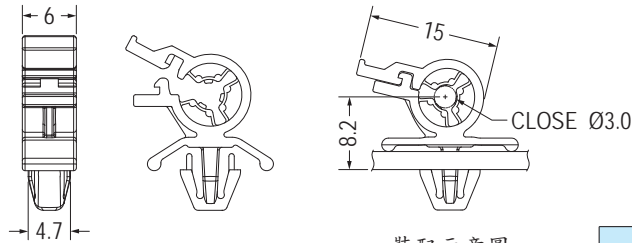
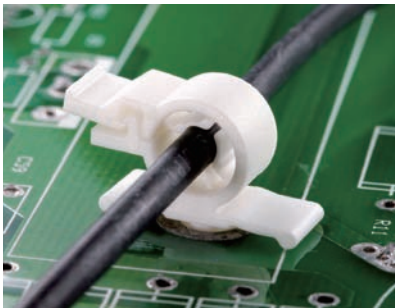

MOUNTING HOLE Ø4.8
THICKNESS 0.5-2.0

裝配示意圖
Assembly Diagram



Part No.	Package
SLCPA-3	500

4

隔離束線座 STANDOFF CABLE CLIP



- Material: Nylon 66 (UL)
- Flame Class: 94V-2/94V-0
- Color: Natural/Black
- Unit: mm

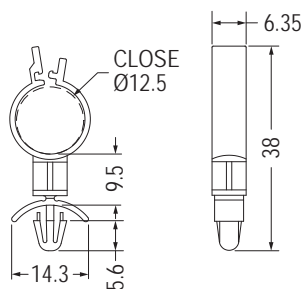

MOUNTING HOLE Ø4.8
THICKNESS 0.8-2.0

Part No.	Package
SLC-19	500

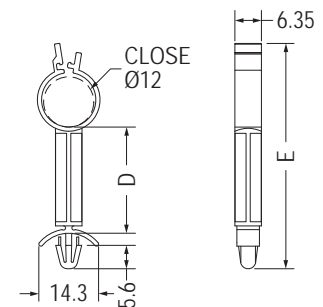

MOUNTING HOLE Ø4.8
THICKNESS 0.8-2.0

Part No.	D	E	Package
SLCC-12.7	12.7	41.2	500
SLCC-15.9	15.9	44.4	
SLCC-19.1	19.1	47.6	
SLCC-22.2	22.2	50.7	
SLCC-25.4	25.4	53.9	

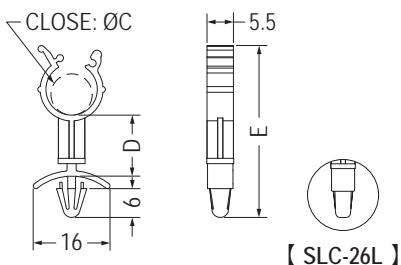

MOUNTING HOLE Ø4.8
THICKNESS 0.8-2.0

【 SLC-26L 】

Part No.	C	D	E	Package
SLC-21	8.6	12.7	35.8	500
SLC-22	12.2	12.7	39.4	
SLC-24	8.6	6.4	29.5	
SLC-25	8.6	19.1	42.1	
SLC-26	6.7	19.1	39.3	
SLC-26L	6.7	19.1	39.3	

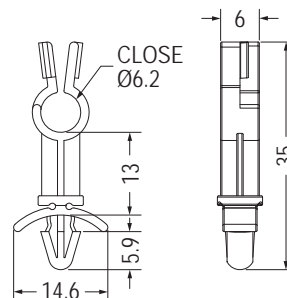

MOUNTING HOLE Ø4.8-Ø5.0
THICKNESS 0.7-2.0

Part No.	Package
SLCE-13	500

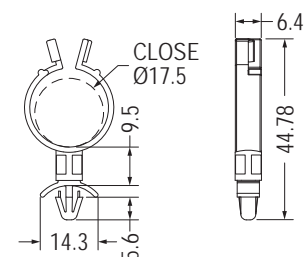

MOUNTING HOLE Ø4.8
THICKNESS 1.6

Part No.	Package
SLCD-9.5	500

隔離束線座 STANDOFF CABLE CLIP

用途：固定電線於PC板或機板上，強韌牢固，維修方便，不佔空間。

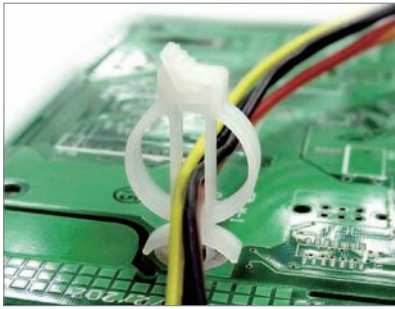

- Material: Nylon 66 (UL)
- Flame Class: 94V-2/94V-0
- Color: Natural/Black
- Unit: mm

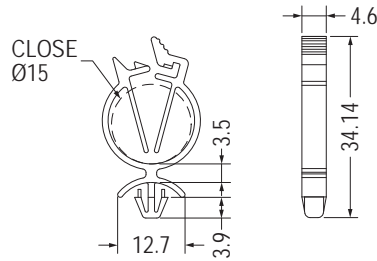

MOUNTING HOLE Ø4.8
THICKNESS 0.8-2.0

Part No.	Package
SLCA-15	500

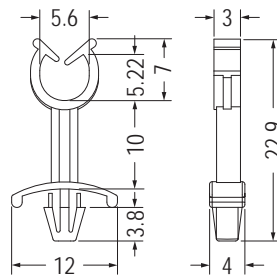
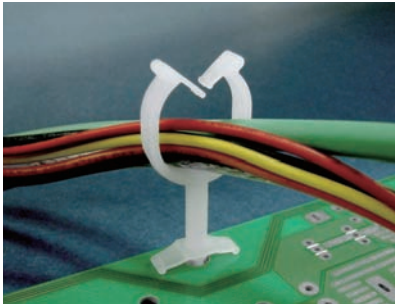

MOUNTING HOLE Ø3.5
THICKNESS 0.6-1.6

Part No.	Package
THE-11	500

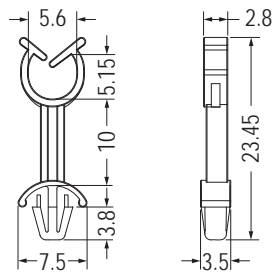

MOUNTING HOLE Ø3.5
THICKNESS 1.2-2.0

Part No.	Package
THE-39	500

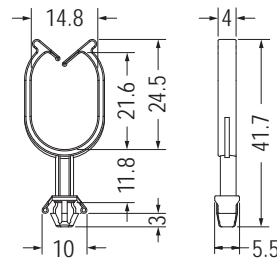

MOUNTING HOLE Ø4.8-Ø5.0
THICKNESS 0.5-2.0

Part No.	Package
THE-38	500

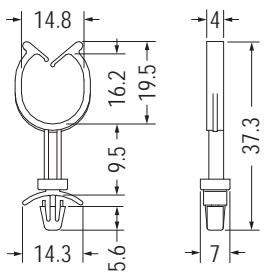

MOUNTING HOLE Ø4.8-Ø5.0
THICKNESS 0.5-2.3

Part No.	Package
THE-9	500

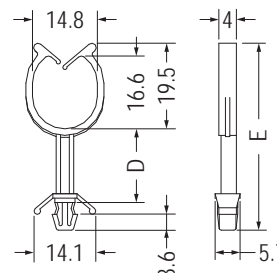

MOUNTING HOLE Ø4.8-Ø5.0
THICKNESS 0.5-2.3

Part No.	D	E	Package
THE-12	12.7	38.5	500
THE-17	16.8	42.6	
THE-25	25.0	50.8	
THE-37	36.8	62.6	

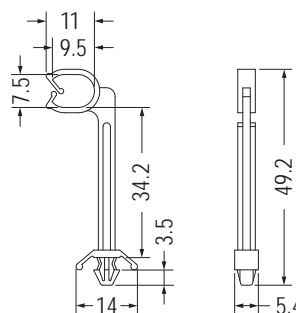

MOUNTING HOLE Ø4.8-Ø5.0
THICKNESS 0.5-2.1

Part No.	Package
THEL-41	500

扭式固定座 TWIST LOCK

用途：可快速細紮及解開電線，安裝容易。

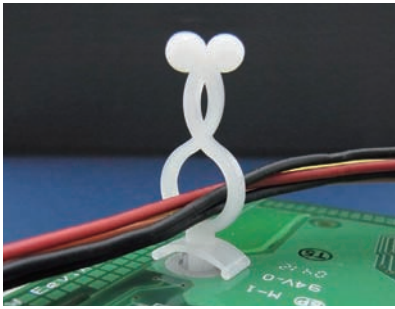

- Material: Nylon 66 (UL)
- Flame Class: 94V-2/94V-0
- Color: Natural/Black
- Unit: mm



Part No.	A	B	C	D	E	F	G	T	Package	UL
THA-1	16.1	6.0	6.1	3.1	33.8	7.3	4.8~5.0	0.8~3.0	1000	UL
THA-2	16.0	5.9	6.1	20.0	51.0	7.3	4.8~5.0	0.8~3.0	500	UL
THA-3	16.0	5.9	6.1	35.3	66.0	7.3	4.8~5.0	0.8~3.0		UL
THA-4	16.0	6.0	9.8	2.8	39.6	7.3	4.8~5.0	0.8~3.0	1000	UL
THA-5	16.0	6.0	9.8	20.0	56.8	7.3	4.8~5.0	0.8~3.0	500	UL
THA-6	16.2	5.9	9.8	35.2	71.5	7.3	4.8~5.0	0.8~3.0		UL
THA-7	16.0	5.9	13.8	3.0	42.0	7.3	4.8~5.0	0.8~3.0	1000	UL
THA-8	16.1	6.0	13.8	20.4	59.3	7.3	4.8~5.0	0.8~3.0	500	UL
THA-9	16.0	5.9	13.8	35.8	74.7	7.3	4.8~5.0	0.8~3.0		UL
THA-10	16.0	6.0	18.4	16.2	63.5	7.3	4.8~5.0	0.8~3.0		UL
THA-11	16.0	5.4	22.3	3.0	56.8	7.3	4.8~5.0	0.8~2.5		UL
THA-12	16.0	6.0	9.7	15.8	53.1	7.3	4.8~5.0	0.8~3.0		UL
THA-14	16.0	6.0	18.7	8.0	55.3	7.3	4.8~5.0	0.8~3.0		UL
THA-15	16.4	6.0	6.8	10.5	43.8	7.3	4.8~5.0	0.8~3.0		
THA-16	10.5	6.0	7.0	5.6	34.7	7.3	4.8~5.0	0.8~2.0		
THA-19	13.8	6.0	9.8	4.4	40.9	7.2	4.8~5.0	0.8~2.5		
THA-21	12.9	4.8	7.7	8.0	37.7	3.7	3.0	0.8~2.4		1000
THA-22	15.5	4.9	18.5	8.1	58.2	5.8	3.5	1.0~2.0	500	

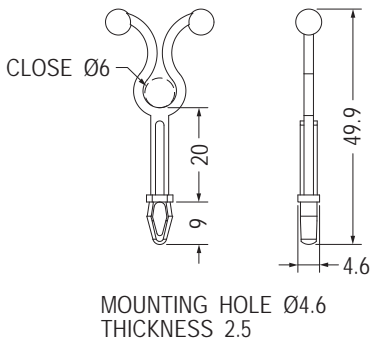
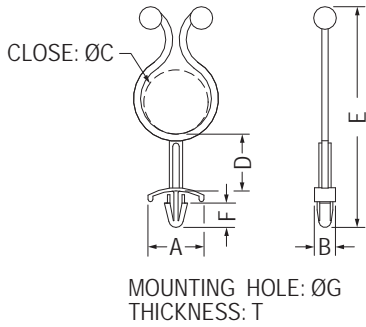

MOUNTING HOLE Ø4.6
THICKNESS 2.5

Part No.	Package
THN-1	500

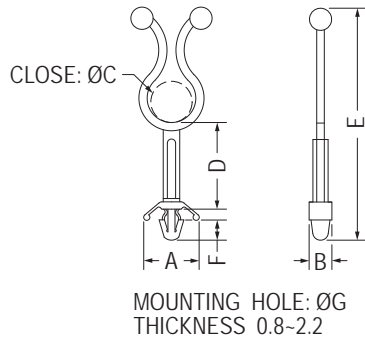

Part No.	A	B	C	D	E	F	G	Package
THC-1	13.8	5.5	10.4	21.0	56.5	5.0	4.8	500
THC-1S	9.2	4.9	7.2	3.0	26.7	3.1	4.0	1000
THC-2	13.8	5.6	5.0	34.0	59.8	5.0	4.8	500
THC-3	14.0	5.6	10.4	4.5	37.7	5.0	4.8	1000
THC-4	13.5	5.7	10.0	43.5	78.1	4.9	4.8	250

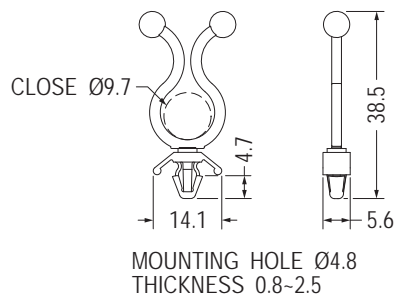

MOUNTING HOLE Ø4.8
THICKNESS 0.8~2.5

Part No.	Package
THC-6	1000

扭式固定座 TWIST LOCK

用途：可快速綑紮及解開電線，安裝容易。

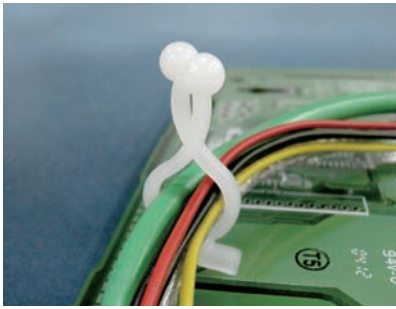

- Material: Nylon 66 (UL)
- Flame Class: 94V-2/94V-0
- Color: Natural/Black
- Unit: mm

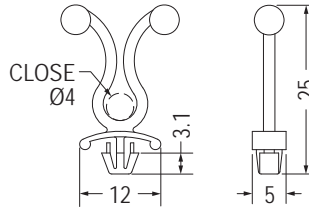

MOUNTING HOLE Ø4.0
THICKNESS 0.8-2.0

Part No.	Package
THC-5	1000

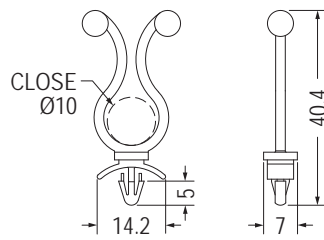

MOUNTING HOLE Ø4.0
THICKNESS 0.8-2.0

Part No.	Package
THI-4	500

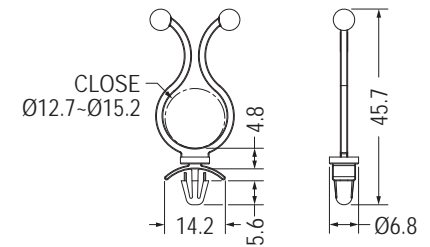

MOUNTING HOLE Ø4.75-Ø4.8
THICKNESS 0.8-2.0

Part No.	Package
★THD-5	500

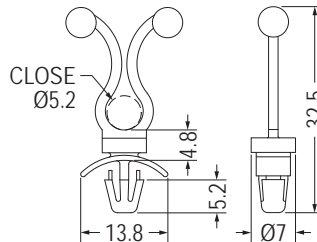
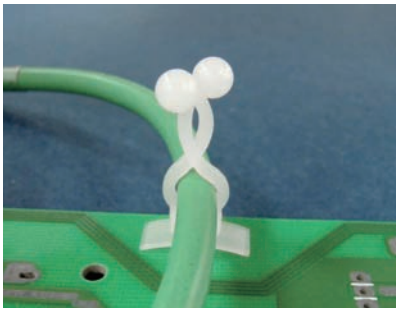

MOUNTING HOLE Ø4.8
THICKNESS 0.8-2.0

Part No.	Package
THL-4.8	1000

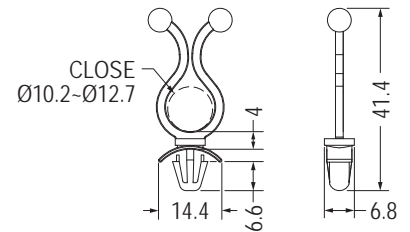

MOUNTING HOLE Ø6.0
THICKNESS 0.78-2.0

Part No.	Package
THD-3	500

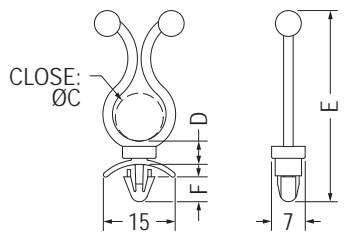
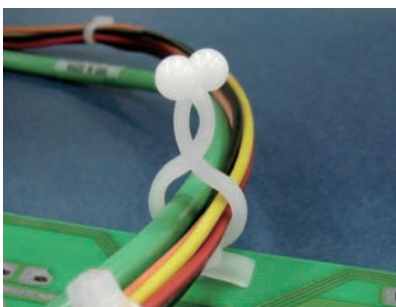

MOUNTING HOLE Ø4.8-Ø5.0
THICKNESS 0.8-2.0

Part No.	C	D	E	F	Package
THD-1	9.8	4.9	40.2	5.2	500
THD-2	17.1	4.9	49.4	5.2	
THD-4	17.5	4.85	47.6	3.6	

扭式固定座 TWIST LOCK

用途：可快速細紮及解開電線，安裝容易。

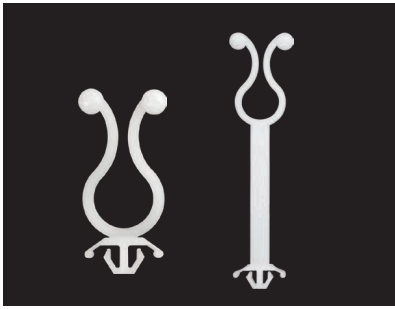

- Material: Nylon 66 (UL)
- Flame Class: 94V-2/94V-0
- Color: Natural/Black
- Unit: mm

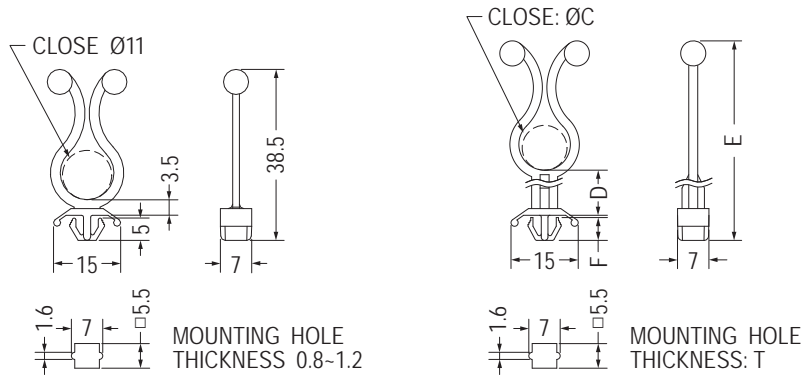

Part No.	Package
THG-12	500

Part No.	C	D	E	F	T	Package
THG-13	10.0	47.0	81.45	5.1	0.8~1.6	500
THG-14	18.0	6.0	52.2	5.9	1.0~2.0	

4

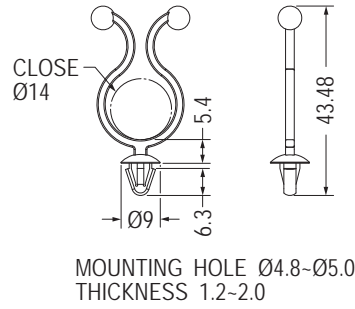
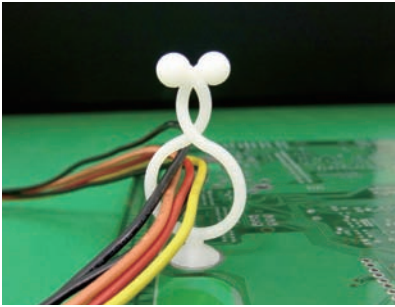

Part No.	Package
THCA-1	500

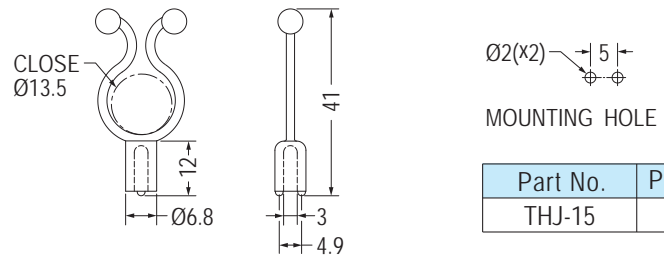
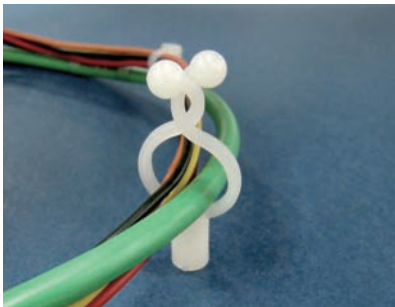

Part No.	Package
THJ-15	500

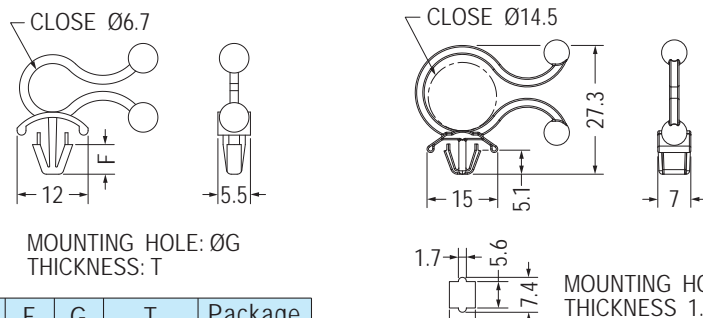

Part No.	F	G	T	Package
THH-8	5.0	4.0	1.6~4.0	500
THH-9	3.5	3.0	0.8~2.0	

Part No.	Package
THH-13	500

扭式固定座 TWIST LOCK

用途：固定電線於PC板或機板上，維修方便，不佔空間。



- Material: Nylon 66 (UL)
- Flame Class: 94V-2/94V-0
- Color: Natural/Black
- Unit: mm

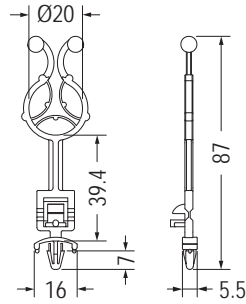

CABLE BUNDLE RANGE 3.5-12.0

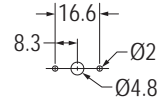

MOUNTING HOLE THICKNESS 0.8-2.0

Part No.	Package
THFA-1	500

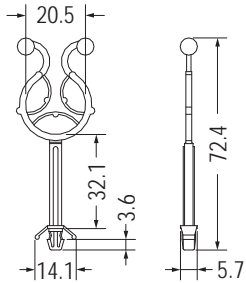
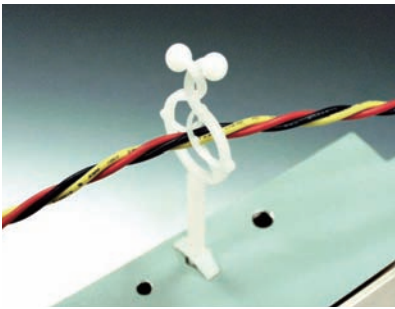

MOUNTING HOLE Ø4.8-Ø5.0 THICKNESS 0.5-2.3



Part No.	Package
THF-1	500

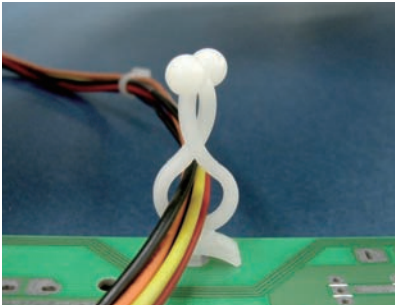

- Material: Nylon 66 (UL)
- Flame Class: 94V-2/94V-0
- Color: Natural/Black
- Unit: mm

用途：可快速捆紮及解開電線，裝配容易，可用於木板上。

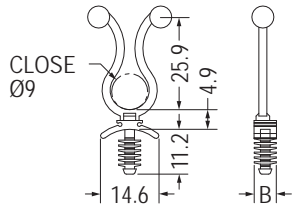

MOUNTING HOLE: ØG

Part No.	B	G	Package
WKL-10	5.5	5.0	500
WKL-10A	5.0	4.5	

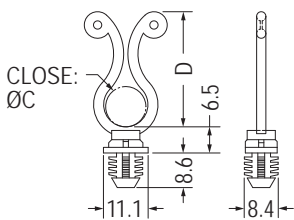

MOUNTING HOLE Ø7.9 PANEL THICKNESS 6.4

Part No.	C	D	Package
WTL-11	10.0	28.6	500
WTL-19	18.0	37.5	

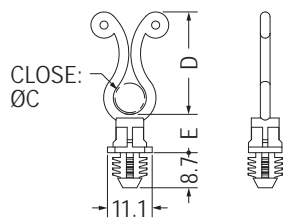

MOUNTING HOLE Ø7.9 PANEL THICKNESS 6.4

Part No.	C	D	E	Package
WTL-764	7.6~10.2	25.4	6.4	500
WTL-795	7.6~10.2	25.4	9.5	
WTL-7127	7.6~10.2	25.4	12.7	
WTL-7159	7.6~10.2	25.4	15.9	
WTL-1064	10.2~12.7	28.6	6.4	
WTL-1095	10.2~12.7	28.6	9.5	
WTL-10127	10.2~12.7	28.6	12.7	
WTL-10159	10.2~12.7	28.6	15.9	
WTL-1764	17.8~20.3	38.1	6.4	
WTL-1795	17.8~20.3	38.1	9.5	
WTL-17127	17.8~20.3	38.1	12.7	
WTL-17159	17.8~20.3	38.1	15.9	

扭式固定座 TWIST LOCK

用途：背膠式，可快速拆卸，固定電線，維修方便，整齊美觀。

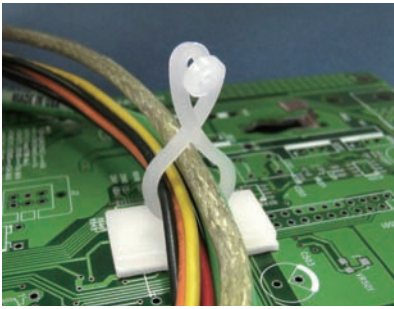

- Material: Nylon 66 (UL)
- Flame Class: 94V-2/94V-0
- Color: Natural/Black
- Unit: mm

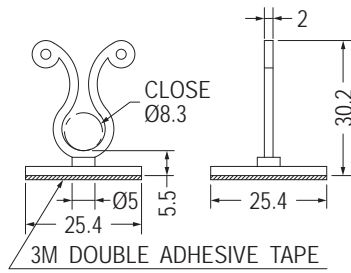

Part No.	Package
KLS-1	250

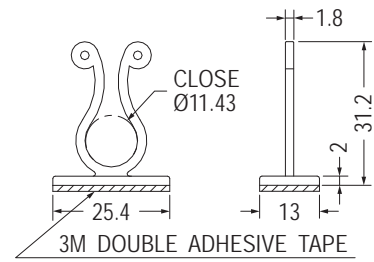

Part No.	Package
KLF-11	500

4

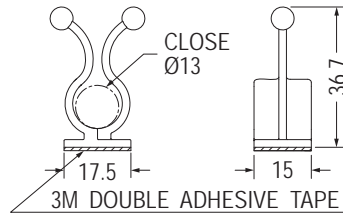

Part No.	Package
KL-26	250

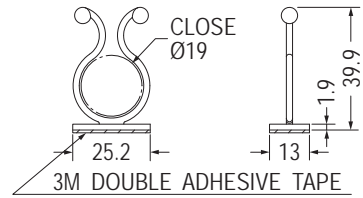

Part No.	Package
KLR-1	500

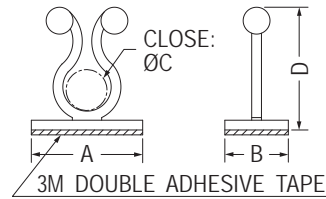

Part No.	A	B	C	D	Package	UL
KL-1	20.0	20.0	13.8	31.9	250	UL
KL-2	20.0	14.0	8.5	26.2	500	UL
KL-2L	25.0	13.0	8.2	27.9		UL
KL-3	21.0	19.0	10.0	28.2		UL
KL-4	18.5	21.0	10.0	27.3		100
KL-5	38.0	20.0	34.0	56.2	100	UL
KL-6	10.0	19.8	5.8	27.6	500	UL
KL-7	20.0	13.0	7.2	21.9		
KL-11	21.0	19.0	10.0	30.0		
KL-14	22.1	13.0	12.5	34.8	250	UL
KL-16	25.0	13.0	17.0	37.0		
KL-19	25.0	13.0	20.0	39.0		
KL-22	28.0	15.0	23.0	41.0		
KL-23	25.0	20.0	13.2	34.7		
KL-25	24.9	17.9	18.0	38.0		

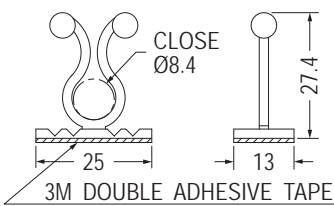

Part No.	Package
KLB-1	500

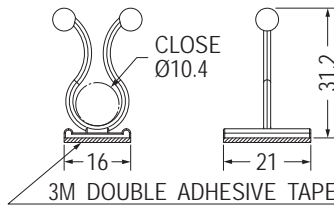

Part No.	Package
KLC-1	250

扭式固定環 TWIST LOCK

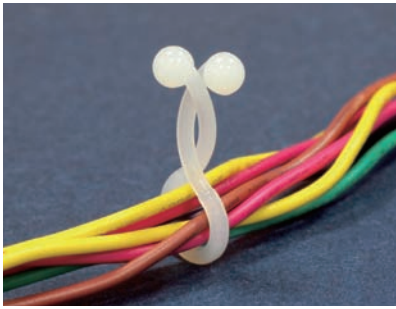

- Material: Nylon 66 (UL)
- Flame Class: 94V-2/94V-0
- Color: Natural/Black
- Unit: mm

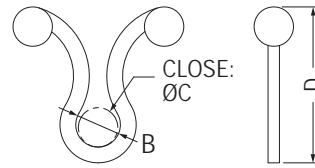
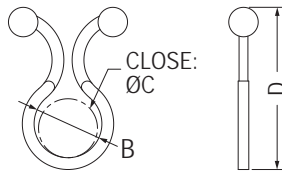

【 TL-34, TL-36, TL-37 】

UL
E217732
UL 1565

用途：用於配線中，有快速捆紮及解開之優點，可重複使用。

Part No.	B	C	D	Package	UL
TL-1	5.1	4.0	17.8	1000	UL
TL-2	8.3	7.3	23.8		UL
TL-3A	11.5	10.0	27.5		UL
TL-4	15.4	13.8	30.4		UL
TL-5	18.8	17.2	35.0		UL
TL-6	25.8	24.2	41.4	500	UL
TL-7	22.0	19.5	42.0		UL
TL-8	5.6	5.0	16.5		
TL-9	11.0	9.7	30.0		
TL-10	19.2	16.3	38.5		
TL-11	5.2	4.2	22.0		
TL-12	8.6	8.0	26.0		

Part No.	B	C	D	Package	UL
TL-13	13.2	11.5	32.5	500	
TL-14	15.0	14.5	35.1		
TL-27	27.5	27.0	46.0		
TL-28	29.0	26.8	55.5		
TL-29	18.0	17.0	40.0		
TL-30	19.2	16.5	38.5		
TL-31	18.6	17.0	40.0		
TL-32	14.8	13.5	35.0		
TL-34	5.1	4.0	17.8		
TL-35	34.0	32.0	56.0		
TL-36	22.0	20.0	42.0		
TL-37	24.9	23.0	44.3		
TL-38	40.0	38.0	63.0		

扭式固定座 TWIST LOCK



- Material: Nylon 66 (UL)
- Flame Class: 94V-2/94V-0
- Color: Natural/Black
- Unit: mm

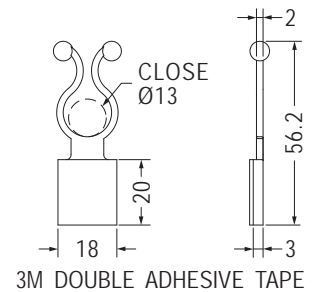
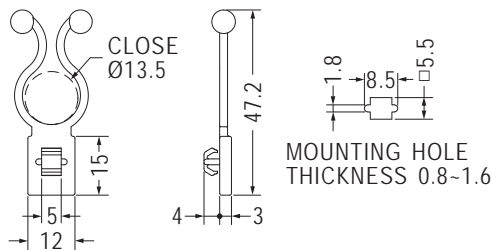

Part No.	Package
THJA-1	500

Part No.	Package
THM-1	1000

用途：可快速細紮及解開電線，安裝容易。

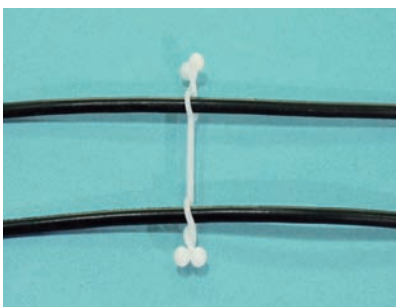

- Material: Nylon 66 (UL)
- Flame Class: 94V-2/94V-0
- Color: Natural/Black
- Unit: mm

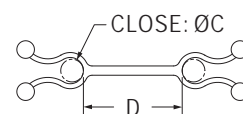
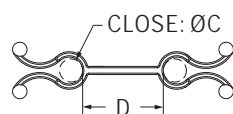
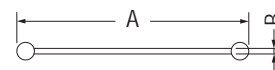
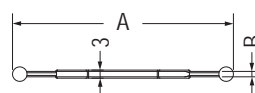

【 2L-10 】

UL
E217732
UL 1565

用途：用於電子內部電線固定，安裝容易，美觀不脫落。

Part No.	A	B	C	D	Package	UL
2L-7	75.0	1.8	6.3	33.2	500	UL
2L-8	56.0	1.6	8.5	13.2		UL
2L-10	82.2	2.0	8.6	30.0		

防落下固定帶 ANIT-TIP STRAPS

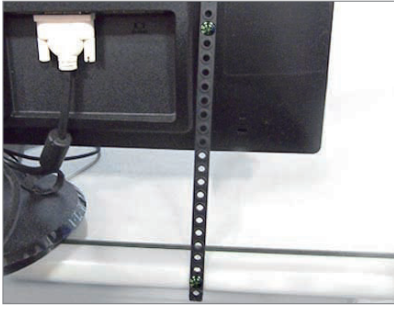

- Material: Nylon 66 (UL)
- Flame Class: 94V-2/94V-0
- Color: Natural/Black
- Unit: mm

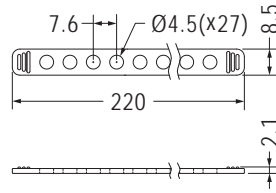

Part No.	Package
CCHD-220	500

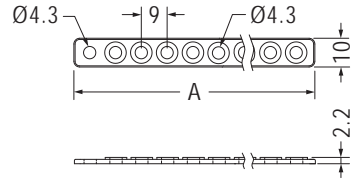

Part No.	A	Poles	Package
CCHD-172	172.75	19.0	500
CCHD-210	210.0	22.0	

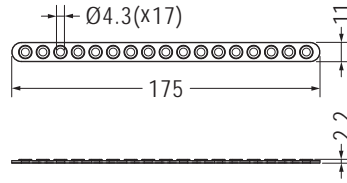

Part No.	Package
CCHD-175	500

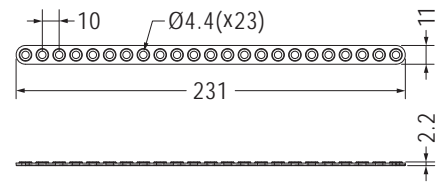

- Material: PP
- Color: Black

Part No.	Package
CCHD-231	500

束線帶固定座 CABLE TIE MOUNT

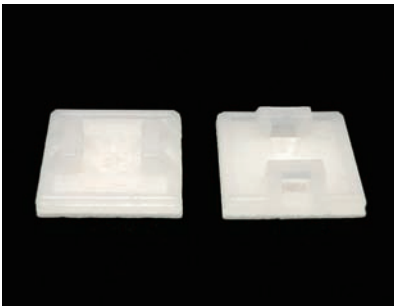

- Material: Nylon 66 (UL)
- Flame Class: 94V-2/94V-0
- Color: Natural/Black
- Unit: mm

用途：配合束線帶使用，固定電線，背膠式亦可配合螺絲，使機器內部走線美麗、整齊。

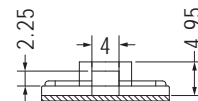
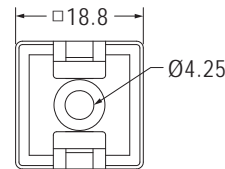

3M DOUBLE ADHESIVE TAPE

Part No.	Package
CM-18	1000

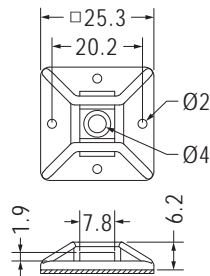
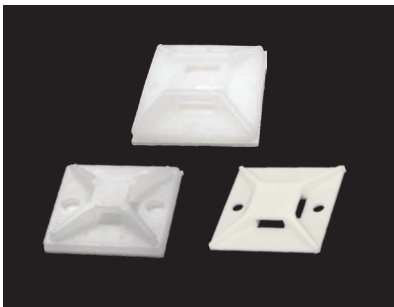

3M DOUBLE ADHESIVE TAPE

Part No.	Package
CM-1	500

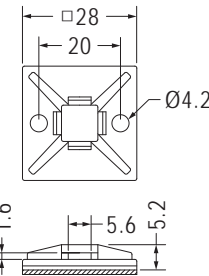

3M DOUBLE ADHESIVE TAPE

Part No.	Package
CM-28S	250

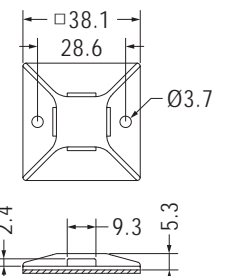

3M DOUBLE ADHESIVE TAPE

Part No.	Package
CM-38	250

束線帶固定座 CABLE TIE MOUNT

用途：配合束線帶使用，固定電線，背膠式亦可配合螺絲，使機器內部走線美麗、整齊。



- Material: Nylon 66 (UL)
- Flame Class: 94V-2/94V-0
- Color: Natural/Black
- Unit: mm

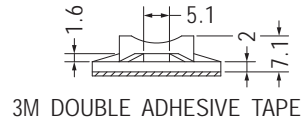
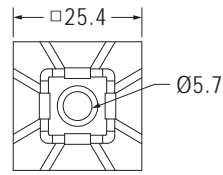

Part No.	Package
CM-25	500

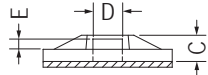
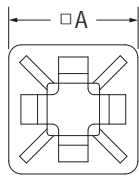

3M DOUBLE ADHESIVE TAPE



Part No.	A	C	D	E	Package	UL
CM-13	13.0	3.2	3.2	1.3	1000	UL
CM-16	16.0	4.0	3.8	1.5		
CM-19	19.1	4.0	4.0	1.6	500	UL
CM-19L	19.5	4.8	5.0	1.7		
CM-20	20.0	4.3	4.8	1.6		UL

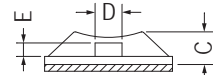
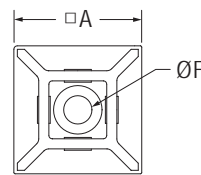

3M DOUBLE ADHESIVE TAPE

Part No.	A	C	D	E	F	Package
CM-19S	19.0	5.0	4.0	1.9	3.0	500
CM-19SL	19.0	5.0	4.0	2.0	4.2	
CM-28	27.8	5.5	6.0	2.0	5.0	250

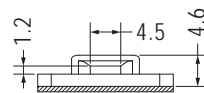
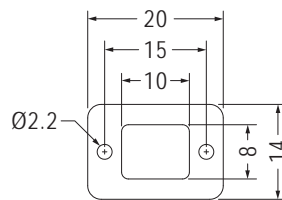
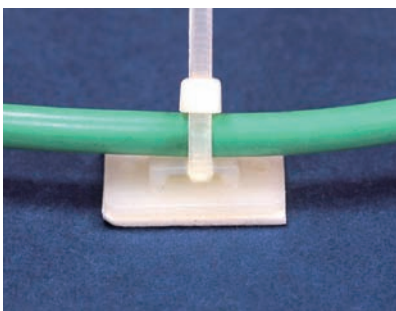

3M DOUBLE ADHESIVE TAPE

Part No.	Package
CM-29	1000

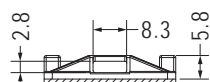
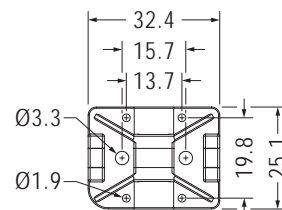

3M DOUBLE ADHESIVE TAPE

Part No.	Package
CM-30	250

束線帶固定座 CABLE TIE MOUNT

用途：用螺絲固定於機板上，配合束線帶固定電線。

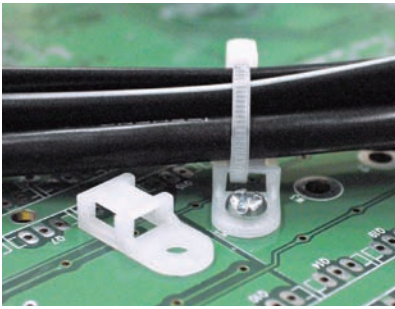

- Material: Nylon 66 (UL)
- Flame Class: 94V-2/94V-0
- Color: Natural/Black
- Unit: mm

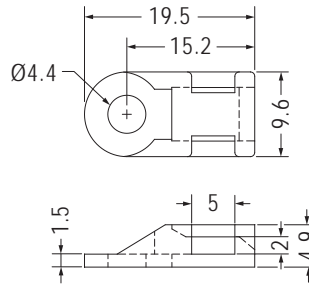

Part No.	Package
TH-1	1000

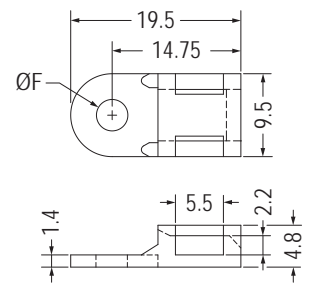

Part No.	F	Package
TH-3	3.6	1000
TH-3L	4.7	

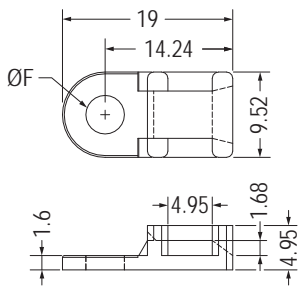

Part No.	F	Package
TH-4	4.3	1000
TH-7	6.5	

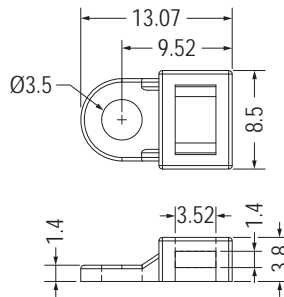

Part No.	Package
TH-6	1000

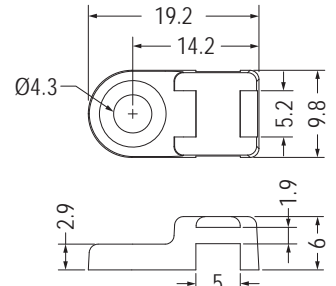

Part No.	Package
TH-5	1000

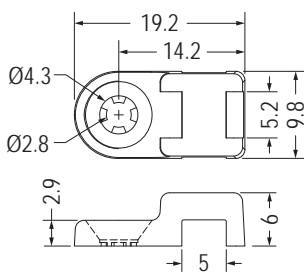

Part No.	Package
TH-5-1	1000

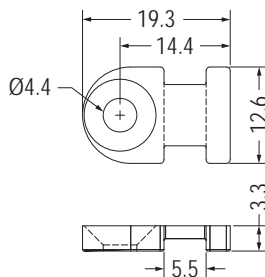

Part No.	Package
TH-8	1000

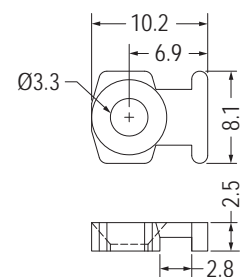

Part No.	Package
TH-9	1000

束線帶固定座 CABLE TIE MOUNT

用途：用螺絲固定於機板上，配合束線帶固定電線。

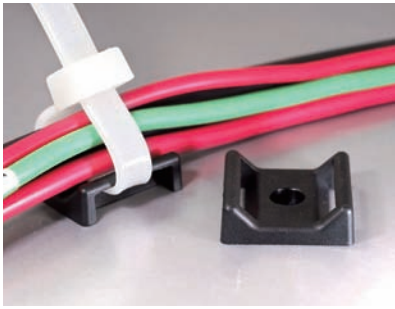

- Material: Nylon 66 (UL)
- Flame Class: 94V-2/94V-0
- Color: Natural/Black
- Unit: mm

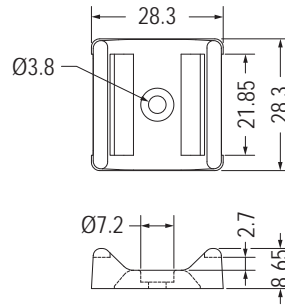

- Material: Nylon 66 (UL)+GF
- Flame Class: 94HB/94V-0

Part No.	Package
TM-4	500

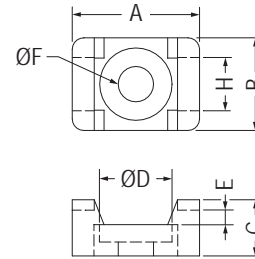
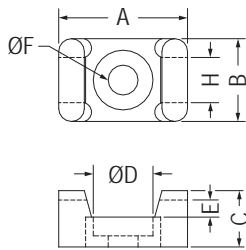

Part No.	A	B	C	D	E	F	H	Package
TH-2	15.2	9.7	6.6	6.9	2.0	3.5	5.2	1000
TH-2S	13.3	8.2	5.85	5.9	1.75	3.2	3.6	

Part No.	A	B	C	D	E	F	H	Package
TM-2S6	14.9	9.6	7.2	7.8	1.5	3.7	5.6	1000
TM-2S8	14.9	9.6	7.2	7.8	1.5	4.5	5.6	
TM-3S8	22.0	16.0	9.6	8.0	2.3	4.5	9.2	500
TM-3S10	22.0	16.0	9.6	9.6	2.3	4.8	9.2	
TM-3S25	22.0	16.0	9.6	12.7	2.3	6.4	9.2	

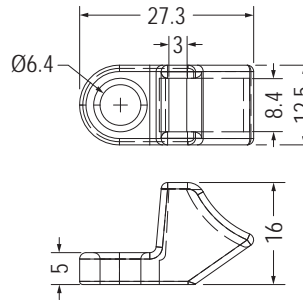

Part No.	Package
THMA-1	1000



- Material: Nylon 66 (UL)
- Flame Class: 94V-2/94V-0
- Color: Natural/Black
- Unit: mm

用途：使用背膠固定於機板上，配合束線帶固定電線。

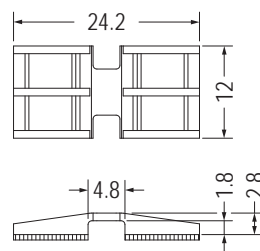

3M DOUBLE ADHESIVE TAPE

Part No.	Package
THU-1	1000

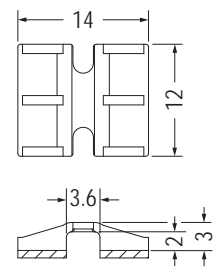

3M DOUBLE ADHESIVE TAPE

Part No.	Package
THU-2	1000

束線帶固定座 CABLE TIE MOUNT

用途：配合束線帶固定電線於機殼上，方便安裝，強韌牢固。

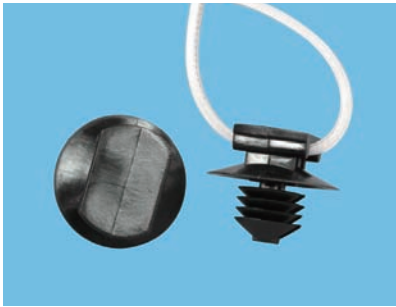

- Material: Nylon 66 (UL)
- Flame Class: 94V-2/94V-0
- Color: Natural/Black
- Unit: mm

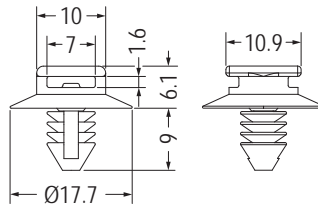

MOUNTING HOLE $\varnothing 6.0\text{-}\varnothing 6.4$
THICKNESS 0.8-9.0

Part No.	Package
CCMF-2	1000

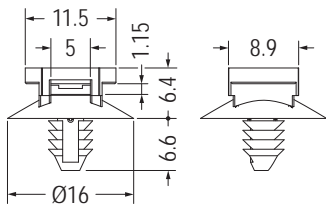

MOUNTING HOLE $\varnothing 4.5\text{-}\varnothing 5.0$
THICKNESS 0.8-7.0

Part No.	Package
CCMF-3	1000

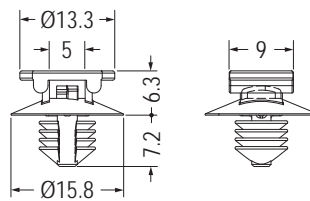

MOUNTING HOLE $\varnothing 6.5\text{-}\varnothing 7.0$
THICKNESS 0.8-3.0

Part No.	Package
CCMF-5	1000

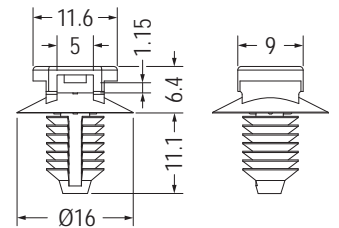

MOUNTING HOLE $\varnothing 6.4\text{-}\varnothing 7.1$
THICKNESS 0.8-6.0

Part No.	Package
CCMF-7	1000

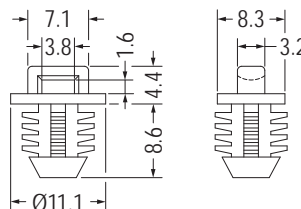

MOUNTING HOLE $\varnothing 7.9$
THICKNESS 6.4

Part No.	Package
CCMF-1	1000

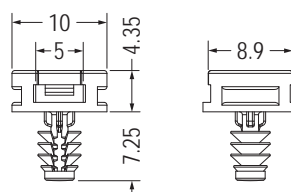

MOUNTING HOLE $\varnothing 3.3\text{-}\varnothing 4.0$ (M4)
THICKNESS 1.0-3.0



• 料號尾碼加-C，做為車規識別

Part No.	Package
CCMF-9-C	1000

束線帶固定座 CABLE TIE MOUNT

用途：配合束線帶固定電線於機殼上，方便安裝，強韌牢固。

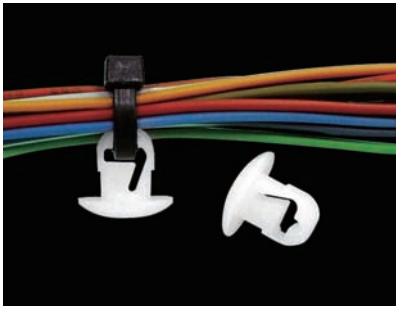

- Material: Nylon 66 (UL)
- Flame Class: 94V-2/94V-0
- Color: Natural/Black
- Unit: mm

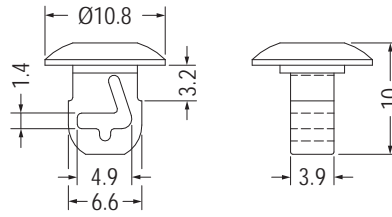

MOUNTING HOLE Ø6.4

Part No.	Package
CCM-1	1000

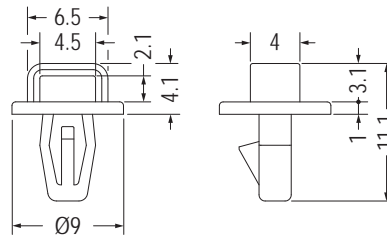

MOUNTING HOLE Ø4.0
THICKNESS 1.6-2.0

Part No.	Package
CCMT-2	1000

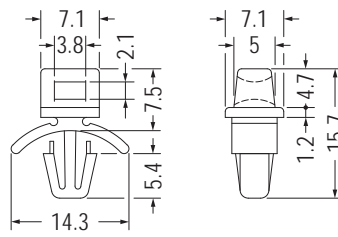
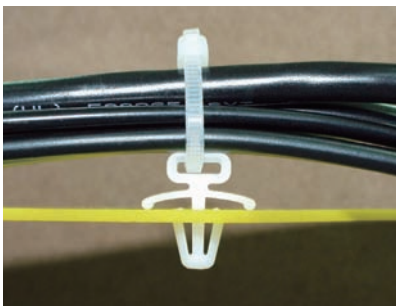

MOUNTING HOLE Ø4.8
THICKNESS 0.8-2.0

• Patented (專利品)

Part No.	Package
CCME-1	1000

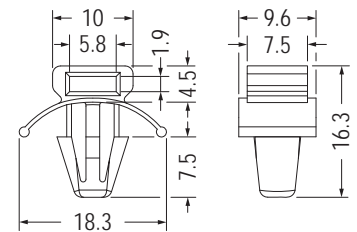

MOUNTING HOLE Ø6.2-Ø6.3
THICKNESS 0.8-3.6

Part No.	Package
CCMW-3	1000

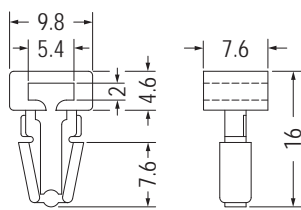

MOUNTING HOLE Ø6.4
THICKNESS 3.17

Part No.	Package
CCMV-1	1000

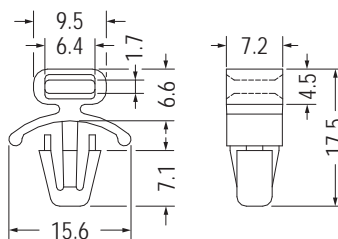

MOUNTING HOLE Ø6.4
THICKNESS 1.2-2.8

Part No.	Package
CCMW-1	1000

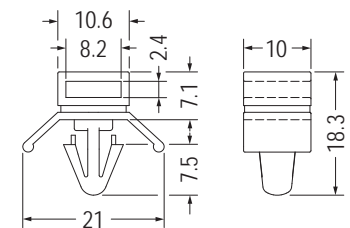

MOUNTING HOLE Ø6.2
THICKNESS 0.8-3.2

Part No.	Package
CCMW-2	1000

電線固定座 WIRE SADDLE



- Material: Nylon 66 (UL)
- Flame Class: 94V-2/94V-0
- Color: Natural/Black
- Unit: mm

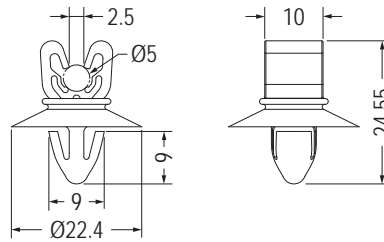

MOUNTING HOLE Ø8.0
THICKNESS 1.2

用途：固定電源於PC板或機板上，維修方便，不佔空間。

Part No.	Package
CHUK-1	500

插頭固定扣 SOCKET MOUNT



- Material: PP (UL)
- Flame Class: 94HB
- Color: Natural/Black
- Unit: mm

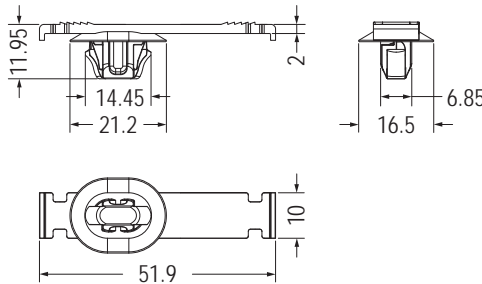

RECOMMENDED MOUNTING HOLE
RECOMMENDED THICKNESS 2.0

用途：配合束線帶固定電線於機殼上，方便安裝，強韌牢固。

Part No.	Package
YJECL-1	500

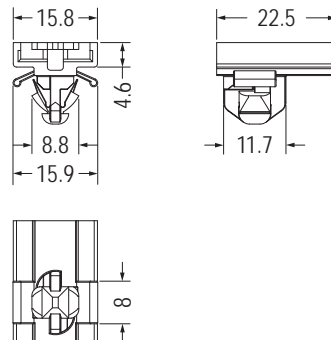

RECOMMENDED MOUNTING HOLE
RECOMMENDED THICKNESS 2.0

Part No.	Package
YJECL-2	500

電線固定扣 CABLE CLAMP



- Material: PC (UL)
- Flame Class: 94V-2
- Color: Natural/Transparent
- Unit: mm

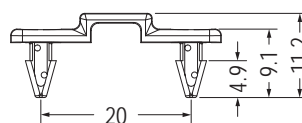

MOUNTING HOLE Ø3.0
THICKNESS 2.4

用途：用於電線之固定。

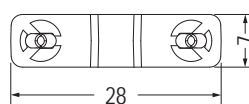

Part No.	Package
LPZ-5	1000

電線固定扣 WIRE BUTTON



- Material: Nylon 6 (UL)
- Flame Class: 94V-2/94V-0
- Color: Natural/Black
- Unit: mm

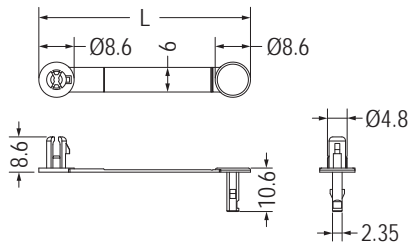

MOUNTING HOLE Ø4.8
THICKNESS: T

Part No.	L	T	Package
CCU-2	51.6	0.8~3.2	500
CCU-3	71.6	0.6~3.0	
CCU-4	99.0	0.6~3.0	

用途：固定電線於機器上，維修方便，不佔空間。

- Material: Nylon 66 (UL)
- Flame Class: 94V-2/94V-0
- Color: Black

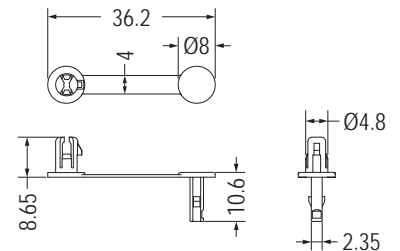

MOUNTING HOLE Ø4.8
THICKNESS 3.5

Part No.	Package
CCU-1	500

接地線夾 GROUNDING CABLE CLAMP

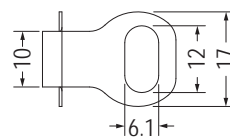
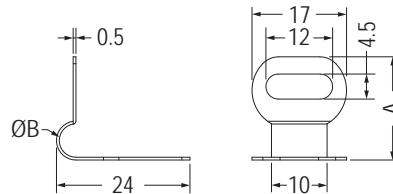

用途：用於夾持隔離電線再用螺絲固定，接地效果佳，防干擾。

- Material: SPTE

Part No.	A	B	Package
KMCC-1	18.55	6.0	500
KMCC-2	19.6	8.0	

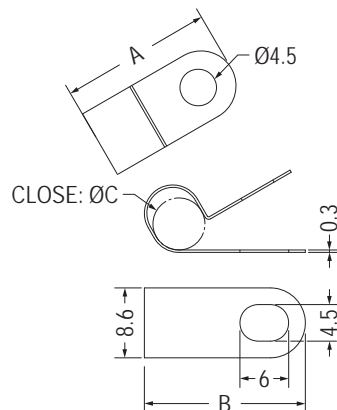

- Material: SUS

Part No.	A	B	C	Package
KTCC-3	17.2	17.6	3.0	1000
KTCC-4	17.2	17.6	4.0	
KTCC-5	17.9	18.7	4.8	
KTCC-6	18.7	19.8	6.4	
KTCC-9	18.65	20.62	9.0	

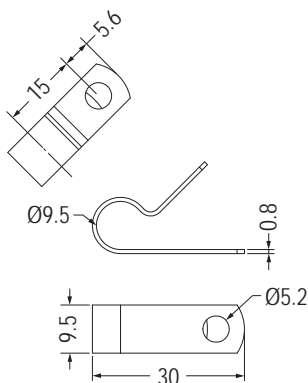

- Material: Aluminum

Part No.	Package
KTCC-22	1000

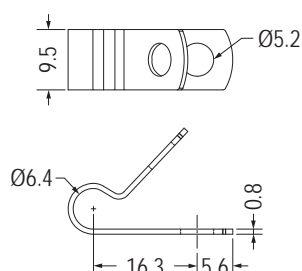

- Material: Aluminum

Part No.	Package
KTCC-23	1000

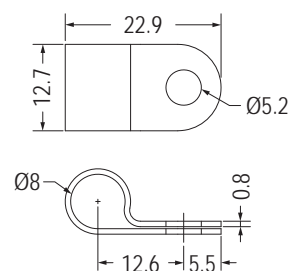

- Material: Aluminum

Part No.	Package
KTCC-12	1000

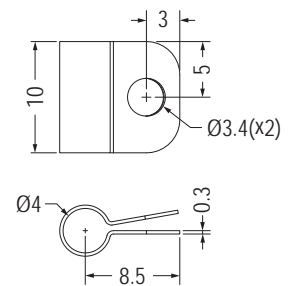

- Material: Steel
- Finish: Zinc Plated

Part No.	Package
KTCC-16	1000

電線固定扣 CABLE CLAMP

用途：配合螺絲，固定電線，整齊美觀。

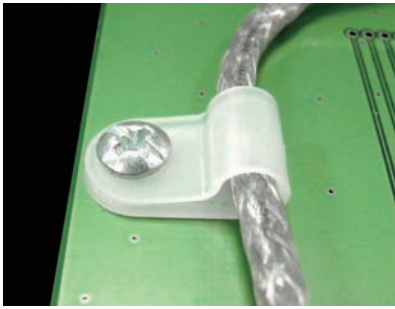

- Material: Nylon 66 (UL)
- Flame Class: 94V-2/94V-0
- Color: Natural/Black
- Unit: mm

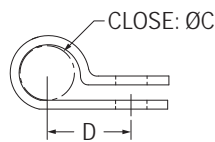
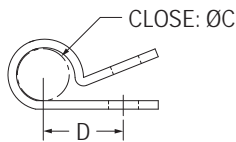
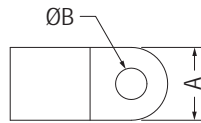
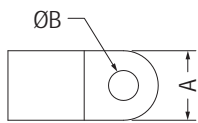

【 CC-10, CC-35, CC-50 】

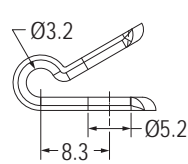
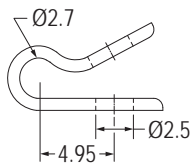
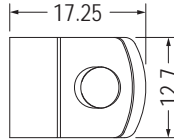
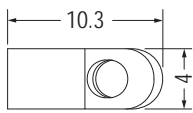

Part No.	Package
CC-28	1000

Part No.	Package
CC-55	1000

Part No.	A	B	C	D	Package
CC-1SS	6.5	3.8	3.2	6.8	1000
CC-1S	9.2	5.4	3.2	8.2	
CC-1	13.2	5.4	3.0	8.9	
CC-2	10.0	5.4	4.5	10.2	
CC-3	9.3	5.0	6.2	10.2	
CC-4	9.5	5.0	7.6	10.5	
CC-4L	9.2	5.4	8.0	10.7	
CC-5	9.5	4.9	9.0	12.4	
CC-5L	12.3	5.4	9.0	13.2	
CC-6	12.7	4.8	11.5	14.7	
CC-7	12.9	5.4	12.8	16.0	
CC-7S	12.5	4.8	15.5	16.7	
CC-8	12.9	5.4	17.0	19.6	
CC-9	12.9	5.4	20.0	21.2	200
CC-10	12.9	5.4	24.0~27.0	23.5	250
CC-12	9.9	4.4	3.0	8.5	1000
CC-13	9.5	3.2	8.3	12.0	
CC-14	6.3	3.7	3.5	6.4	
CC-15	9.6	4.4	5.6	12.1	
CC-16	11.6	6.4	5.6	12.1	
CC-17	10.0	4.2	5.0	9.5	
CC-18	10.0	4.2	11.0	13.0	
CC-19	9.9	4.4	4.5	7.75	
CC-20	10.0	4.3	6.0	9.9	
CC-31	10.0	4.2	11.5	14.0	
CC-32	10.0	4.2	5.0	9.5	
CC-35	6.5	3.3	3.0	9.5	
CC-37	10.9	5.0	7.5	10.5	
CC-38	12.9	6.6	7.5	10.5	
CC-44	10.0	3.5	4.5	10.2	
CC-50	4.0	2.5	3.1	6.0	
CC-51	12.7	5.2	9.5	12.3	
CC-59	12.7	5.2	31.75	26.9	250

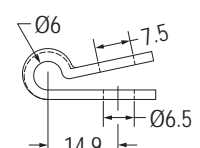
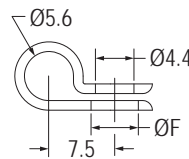
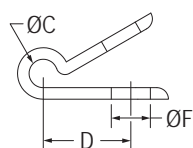
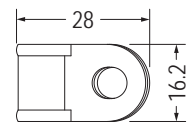
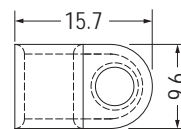
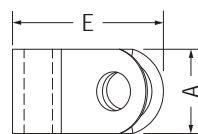

Part No.	A	C	D	E	F	Package
CC-25	9.5	3.2	9.86	17.0	4.4	500
CC-26	9.5	4.8	11.10	19.0	4.4	
★CC-63	12.7	4.8	9.9	19.3	5.2	

Part No.	F	Package
CC-24	5.4	500
CC-45	4.4	

Part No.	Package
CC-21	500

電線固定扣 CABLE CLAMP

用途：配合螺絲，固定電線，整齊美觀。

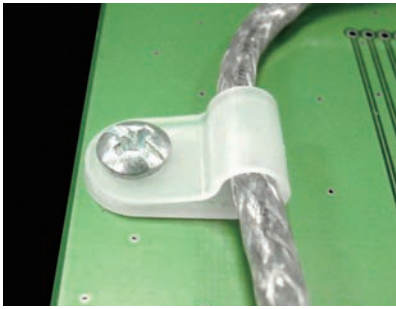

- Material: Nylon 66 (UL)
- Flame Class: 94V-2/94V-0
- Color: Natural/Black
- Unit: mm

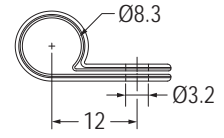
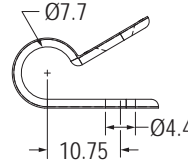
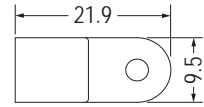
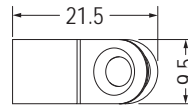

Part No.	Package
CC-53	1000

Part No.	Package
CC-29	1000

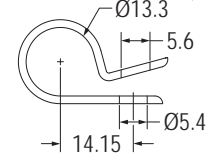
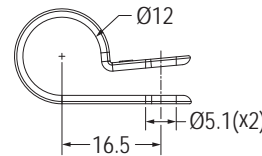
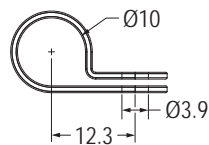
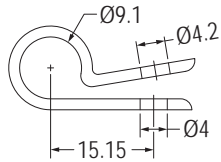
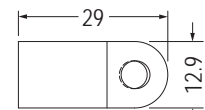
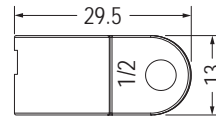
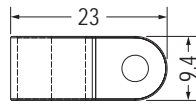
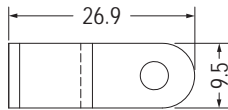

Part No.	Package
CC-42	1000

Part No.	Package
CC-54	1000

Part No.	Package
CC-56	1000

Part No.	Package
CC-23	500

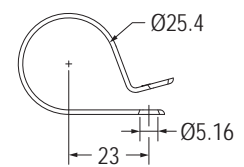
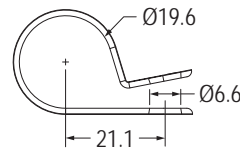
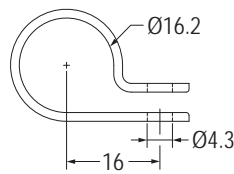
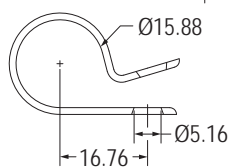
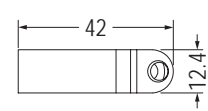
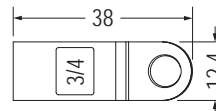
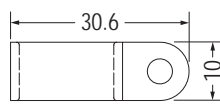
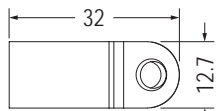

Part No.	Package
CC-57	1000

Part No.	Package
CC-46	1000

Part No.	Package
CC-49	500

Part No.	Package
CC-58	1000

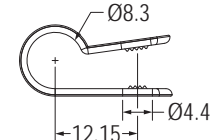
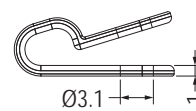
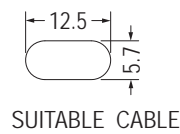
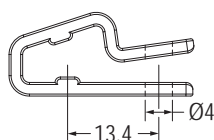
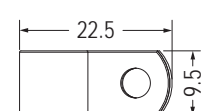
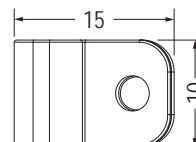
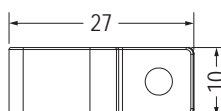

Part No.	Package
CCP-2	1000

Part No.	Package
★CCP-5	1000

Part No.	Package
CCF-1	1000

電線固定扣 CABLE CLAMP

用途：配合螺絲，固定電線，整齊美觀。

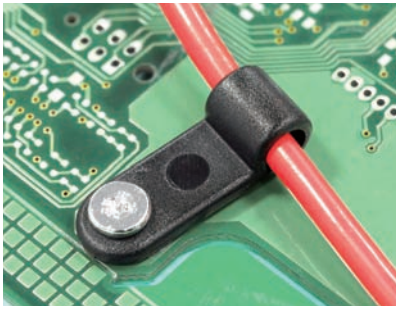

- Material: Nylon 66 (UL)
- Flame Class: 94V-2/94V-0
- Color: Natural/Black
- Unit: mm

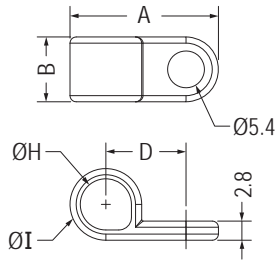

Part No.	A	B	D	H	I	Package
CCO-4	21.75	9.5	11.75	7.5	10.5	500
CCO-5	28.2	10.0	19.0	5.4	8.4	

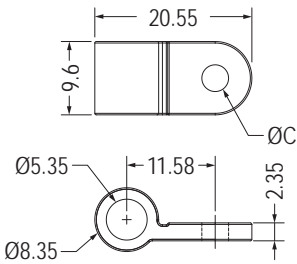

Part No.	C	Package
CCO-1	3.5	500
CCO-2	4.7	

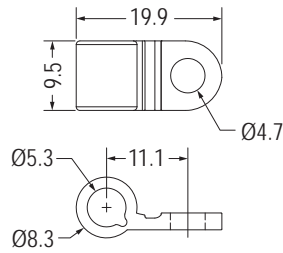

Part No.	Package
CCO-6	500

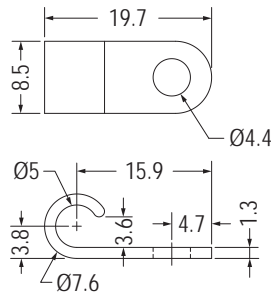
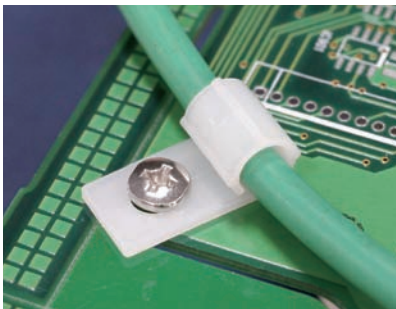

Part No.	Package
CD-5	500

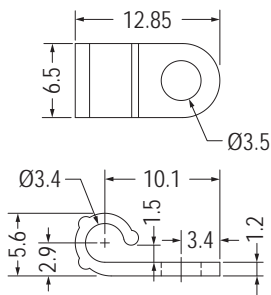

Part No.	Package
CD-3.4	500

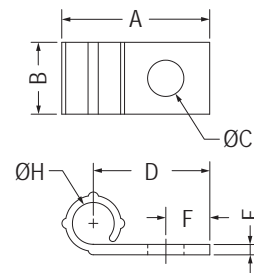

Part No.	A	B	C	D	E	F	H	Package
CD-6	21.2	10.3	5.2	16.7	1.5	6.3	6.0	500
CD-6S	21.2	10.3	3.2	16.7	1.5	6.3	6.0	
CD-9.2	20.6	10.2	5.2	14.0	1.3	4.4	9.2	
CD-9.2S	20.0	10.2	3.2	13.45	1.3	4.5	9.2	

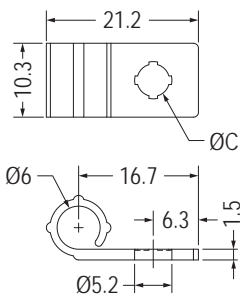

Part No.	C	Package
CDKW-6	4.5	1000
CDKW-6-3	3.0	

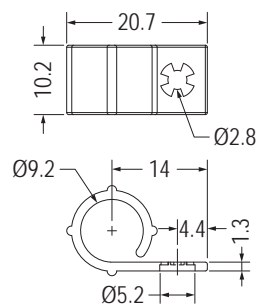

Part No.	Package
CDKW-9.2	1000

電線固定扣 CABLE CLAMP

用途：配合螺絲，固定電線，整齊美觀。

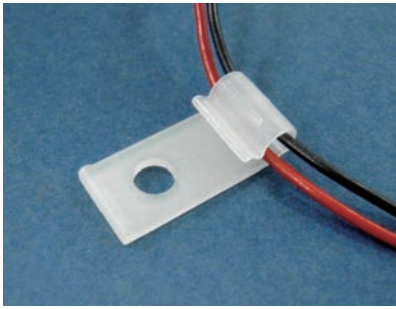

- Material: Nylon 66 (UL)
- Flame Class: 94V-2/94V-0
- Color: Natural/Black
- Unit: mm

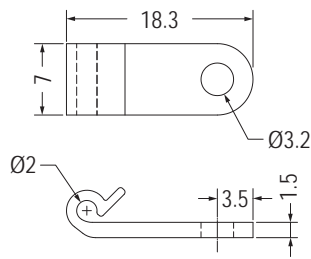

Part No.	Package
CDV-2.3	1000

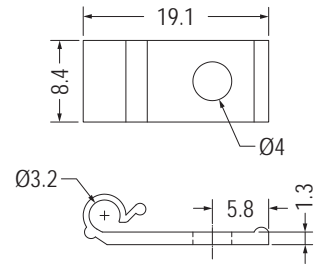

Part No.	Package
CDV-3.2	1000

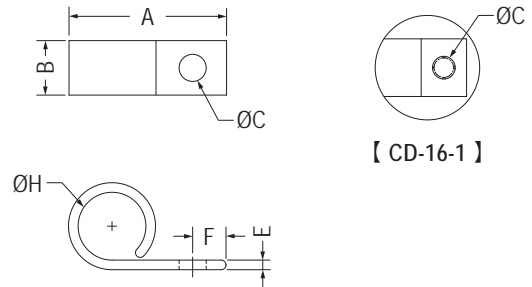
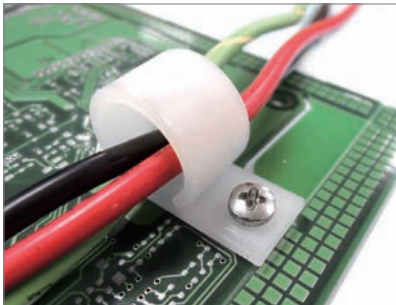

【 CD-16-1 】

Part No.	A	B	C	E	F	H	Package
CD-12.7	29.5	10.2	5.08	1.8	6.35	12.7	500
CD-12.7-3.2	29.5	10.2	3.2	1.8	6.35	12.7	
CD-16	30.0	12.7	5.0	2.0	5.0	16.0	
CD-16-1	30.0	12.7	5.0	2.0	5.0	16.0	
CD-19	32.54	12.7	5.18	2.03	4.82	19.05	
CD-19-6.3	32.54	12.7	6.3	2.03	4.82	19.1	
CD-26	39.85	12.6	5.15	2.2	5.18	26.0	250
CD-40	53.5	12.6	5.0	2.5	4.8	36.9	100

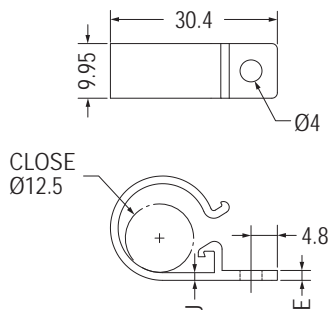

Part No.	E	J	Package
CCA-1	1.8	1.4	500
CCA-2	1.4	1.3	

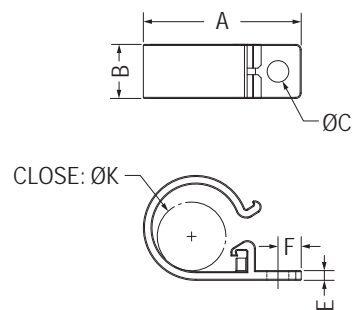

Part No.	A	B	C	E	F	K	Package
CCB-1	29.2	10.0	4.0	1.8	4.3	12.7	500
CCB-1S	29.2	10.0	3.1	1.8	4.3	12.7	
CCB-2	21.0	10.0	4.0	1.2	6.0	5.5	1000
CCB-2S	21.0	10.0	3.1	1.2	6.0	5.5	
CCB-3	39.6	12.7	4.0	2.0	4.2	17.8	200
CCB-4	50.0	12.7	4.0	2.2	4.3	25.0	
★CCB-6	21.0	10.0	4.0	1.2	4.0	7.0	1000

電線固定扣 CABLE CLAMP

用途：使用螺絲將電線固定於機器中，固定電線不易鬆動。

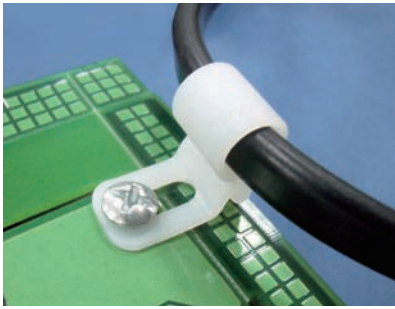

- Material: Nylon 66 (UL)
- Flame Class: 94V-2/94V-0
- Color: Natural/Black
- Unit: mm

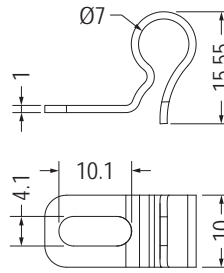

Part No.	Package
CCMG-1	1000

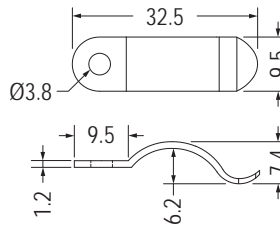
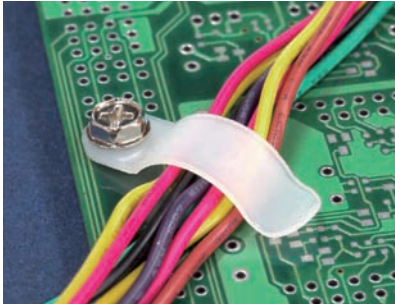

Part No.	Package
CDK-1	1000

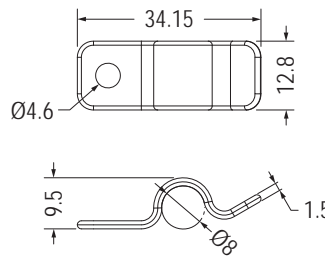

Part No.	Package
CDK-3	1000

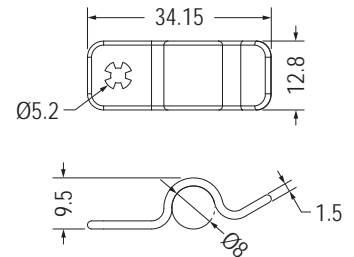

Part No.	Package
CDK-3-1	1000

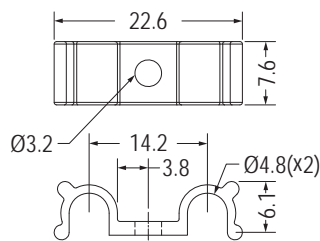

Part No.	Package
CLIA-3	1000

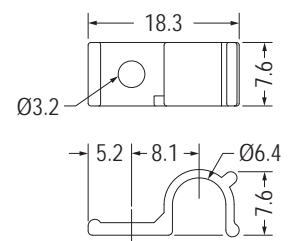

Part No.	Package
CDK-5	1000

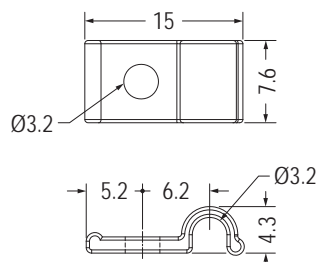

Part No.	Package
CDK-7	1000

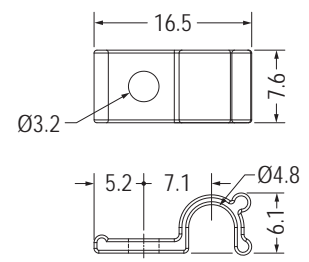

Part No.	Package
CDK-8	1000

電線固定扣 CABLE CLAMP

用途：背膠式，可快速拆卸，固定電線，維修方便，不佔空間。



- Material: Nylon 66 (UL)
- Flame Class: 94V-2/94V-0
- Color: Natural/Black
- Unit: mm

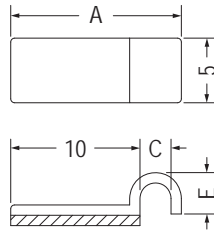

3M DOUBLE ADHESIVE TAPE

Part No.	A	C	E	Package
CDK-2	13.2	2.4	3.2	1000
CDK-6	12.3	1.5	2.4	



- Material: Nylon 66 (UL)
- Flame Class: 94V-2/94V-0
- Color: Natural/Black
- Unit: mm

用途：使用螺絲將電線固定於機器中，固定電線不易鬆動。

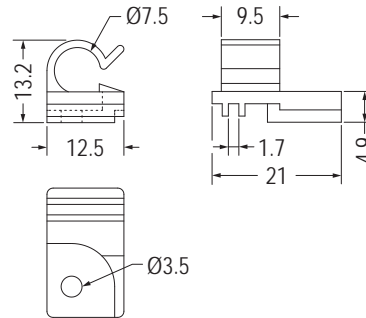

Part No.	Package
WCL-3	500

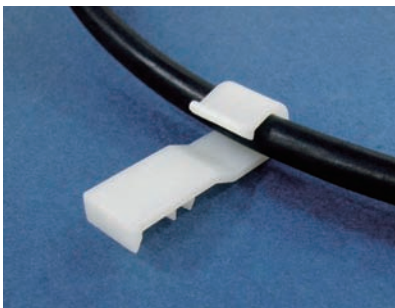

- Material: Nylon 66 (UL)
- Flame Class: 94V-2/94V-0
- Color: Natural/Black
- Unit: mm

用途：固定電線於機器中，整齊美觀。

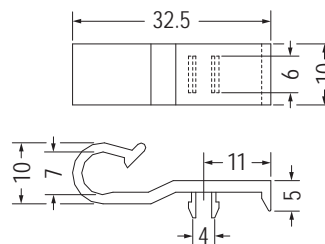

Part No.	Package
WCL-2	500

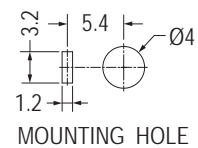
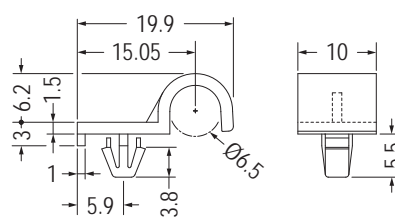
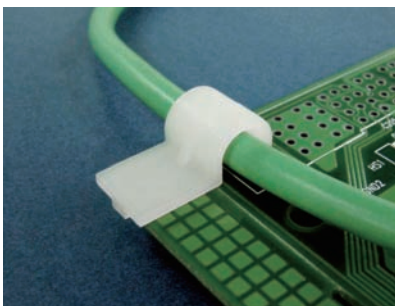

Part No.	Package
CLH-6	500

電線固定扣 CABLE CLAMP

用途：固定電線於機器中，整齊美觀。

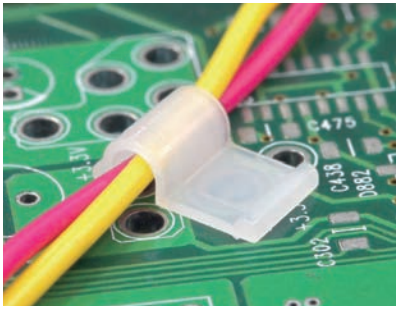

- Material: Nylon 66 (UL)
- Flame Class: 94V-2/94V-0
- Color: Natural/Black
- Unit: mm

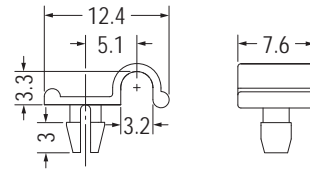

MOUNTING HOLE Ø3.2
THICKNESS 1.6

Part No.	Package
CLI-4	500

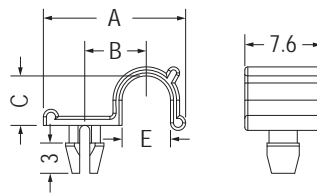

MOUNTING HOLE Ø3.2
THICKNESS 1.6

Part No.	A	B	C	E	Package
CLI-5	14.1	6.1	4.9	4.8	2000
CLI-6	15.8	7.0	6.5	6.1	

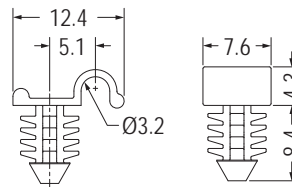
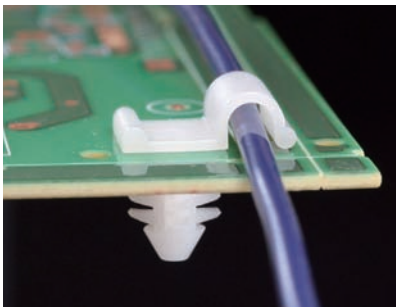

MOUNTING HOLE Ø6.35
THICKNESS 6.35



Part No.	Package
CLK-2	500

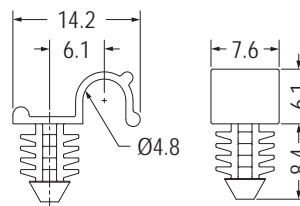
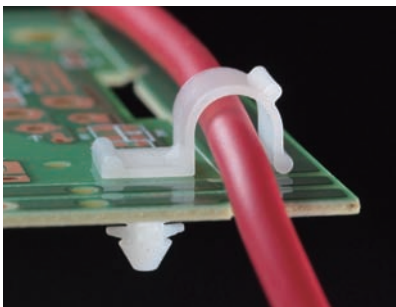

MOUNTING HOLE Ø6.35
THICKNESS 6.35

Part No.	Package
★CLK-3	500

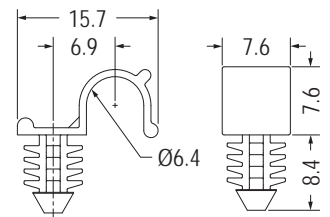

MOUNTING HOLE Ø6.35
THICKNESS 6.35

Part No.	Package
★CLK-4	500

電線固定座 CABLE CLAMP



- Material: Nylon 66 (UL)
- Flame Class: 94V-2/94V-0
- Color: Natural/Black
- Unit: mm

用途：適用螺絲M4、長12，可快速拆卸，固定電線，維修方便，不佔空間。

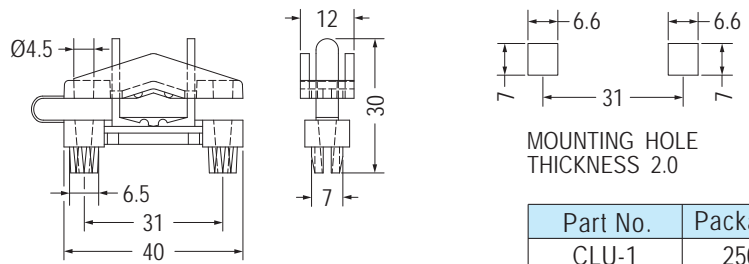

LCD理線座 CABLE CLIP



- Material: HIPS (UL)
- Flame Class: 94HB
- Color: Gray
- Unit: mm

用途：固定LCD-TV背部電線，美觀整齊。

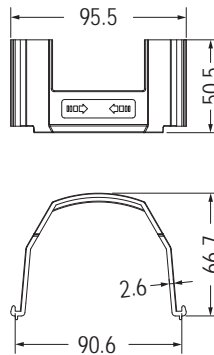

電線固定扣 CABLE CLAMP



- Material: Nylon 66 (UL)
- Flame Class: 94V-2/94V-0
- Color: Natural/Black
- Unit: mm

用途：固定電線於機板上，維修方便，不佔空間。

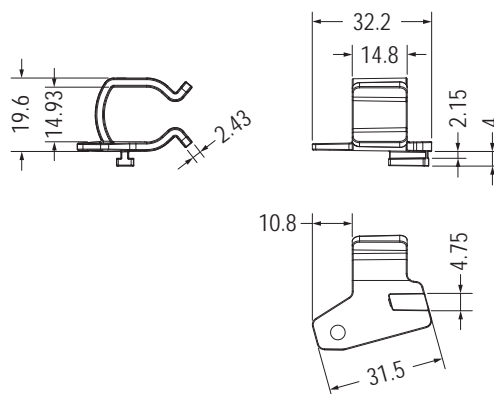

電線固定扣 CABLE CLAMP

用途：固定電線於機器中，整齊美觀。



- Material: Nylon 66 (UL)
- Flame Class: 94V-2/94V-0
- Color: Natural/Black/Blue
- Unit: mm

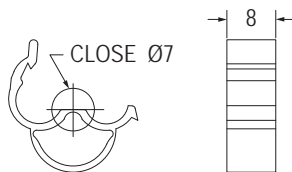

Part No.	Package
WAK-1	1000

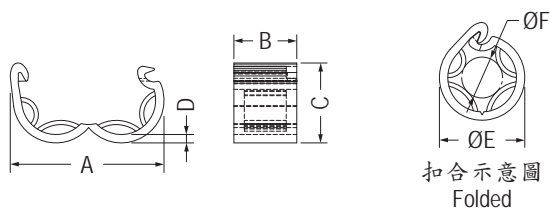

Part No.	A	B	C	D	E	F	Package
WAL-1	14.65	6.0	7.6	0.8	8.15	3.9	1000
WAL-2	18.34	5.3	11.6	1.0	10.20	5.3~5.5	

4

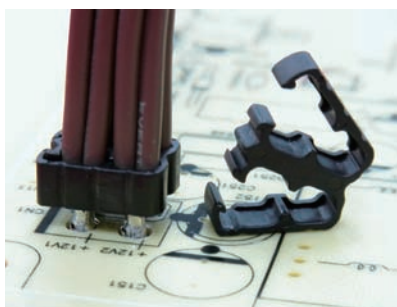

- Material: Nylon 66 (UL)
- Flame Class: 94V-2/94V-0
- Color: Natural/Black
- Unit: mm

用途：固定電線於機器中，防止電線斷路。

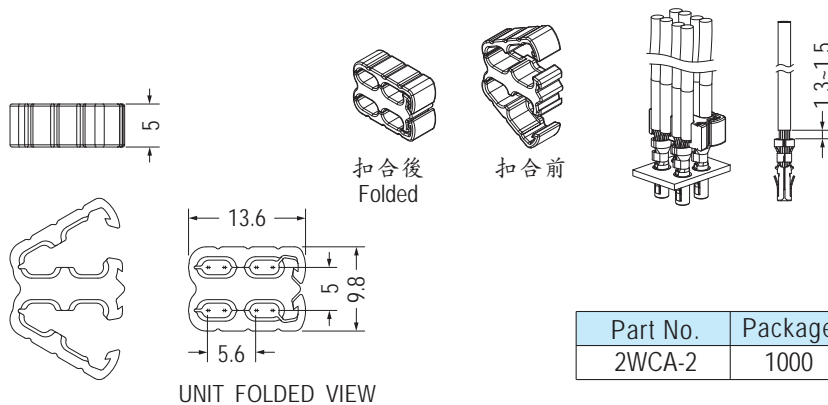

Part No.	Package
2WCA-2	1000

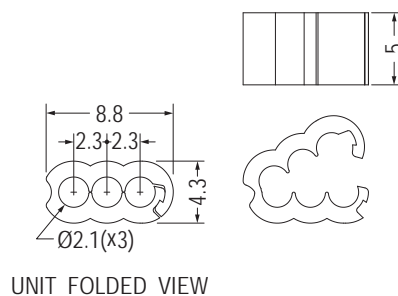

Part No.	Package
3WC-2	1000

電線固定扣 CABLE CLAMP

用途：固定電線於機器中，防止電線斷路。



- Material: Nylon 66 (UL)
- Flame Class: 94V-2/94V-0
- Color: Natural/Black
- Unit: mm

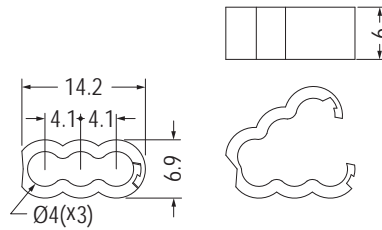

UNIT FOLDED VIEW

Part No.	Package
3WC-4	1000

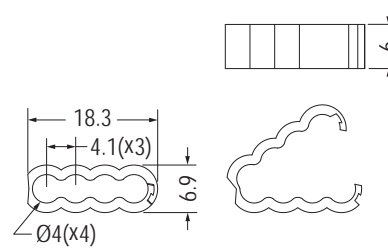

UNIT FOLDED VIEW

Part No.	Package
4WC-4	1000

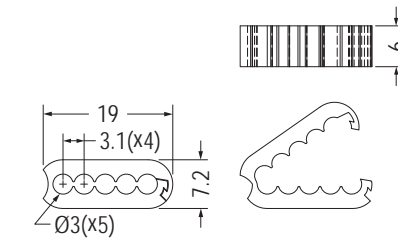
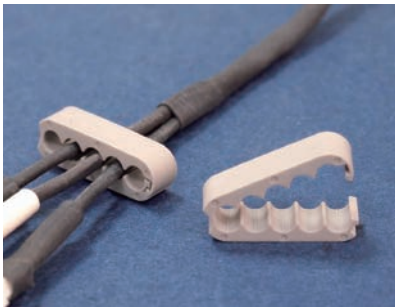

UNIT FOLDED VIEW

- Color: Gray

Part No.	Package
5WC-3	1000

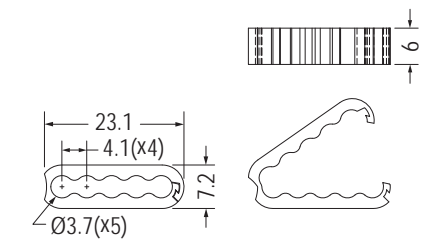

UNIT FOLDED VIEW

- Color: Gray

Part No.	Package
5WC-3.5	1000



- Material: Nylon 66 (UL)
- Flame Class: 94V-2/94V-0
- Color: Natural/Black
- Unit: mm

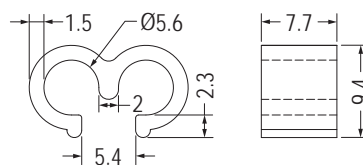

Part No.	Package
MUB-1	1000

用途：固定電線於機器中，整齊美觀。

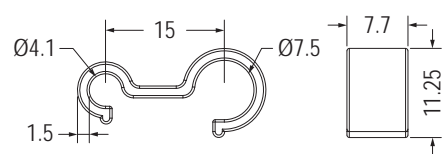

Part No.	Package
MUB-2	1000

電線固定扣 CABLE CLAMP

用途：使用螺絲將電線固定於機器中，固定電線不易鬆動。

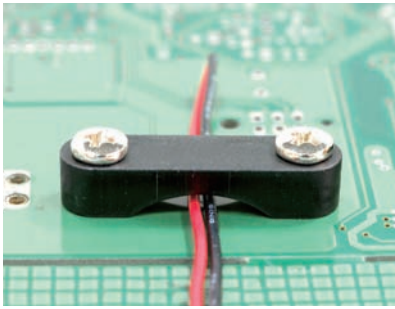

- Material: Nylon 66 (UL)
- Flame Class: 94V-2/94V-0
- Color: Natural/Black
- Unit: mm

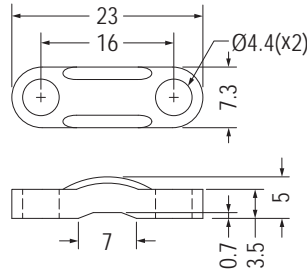

- Flame Class: 94HB

Part No.	Package
CLT-4	1000

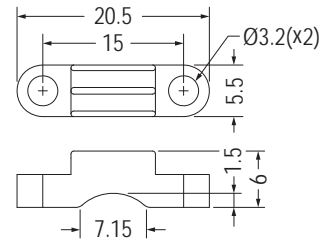

- Material: Nylon 6 (UL)
- Flame Class: 94V-2
- Color: Natural

Part No.	Package
CLT-19	1000

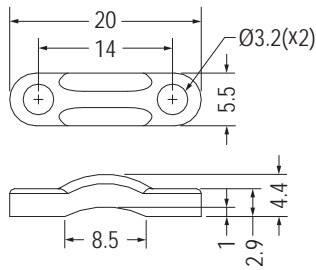

Part No.	Package
CLT-2	500

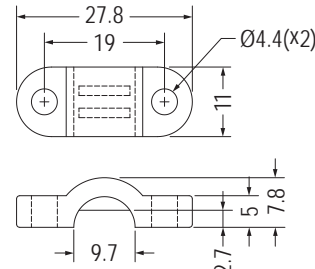

- Material: Nylon 66 (UL)/ABS (UL)/PC+ABS (UL)
- Flame Class: 94HB/94V-2/94V-0

Part No.	Package
CLT-1	500

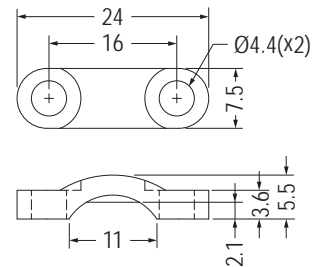

- Flame Class: 94HB

Part No.	Package
CLT-5	1000

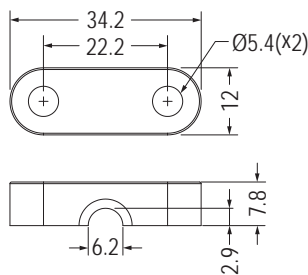

- Material: ABS (UL)
- Flame Class: 94HB

Part No.	Package
CLT-8	1000

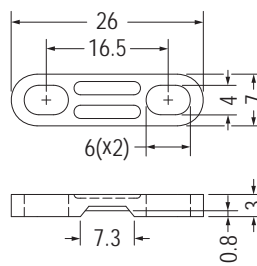

- Flame Class: 94HB

Part No.	Package
CLT-6	1000

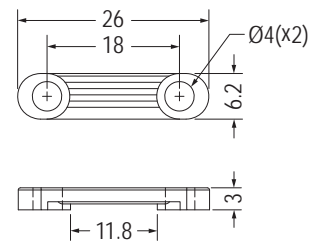

- Material: PBT (UL)
- Flame Class: 94V-0
- Color: Natural

Part No.	Package
CLT-18	500

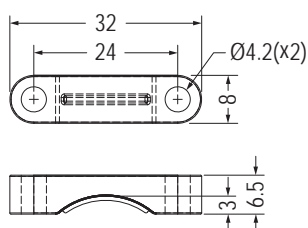

Part No.	Package
CLT-14	1000

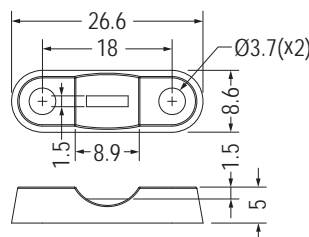

Part No.	Package
CLT-20	1000

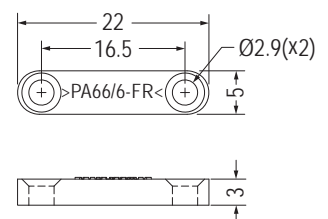

Part No.	Package
CLT-10	1000

電線固定夾片 CABLE CLAMP

用途：使用螺絲將電線固定於機器中，固定電線不易鬆動。



- Material: Nylon 66 (UL)
- Flame Class: 94V-2/94V-0
- Color: Natural/Black/Gray
- Unit: mm

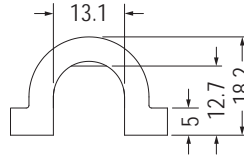
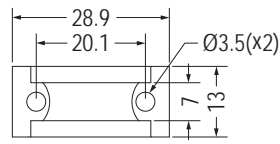

Part No.	Package
CLT-7	500

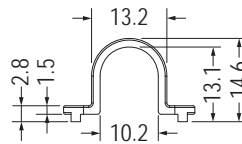
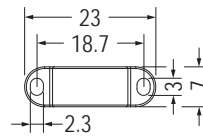

Part No.	Package
CLT-9	1000

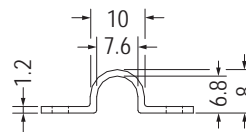
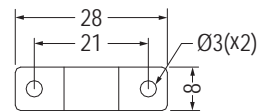

Part No.	Package
CLM-7.5	1000

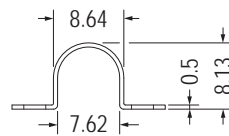
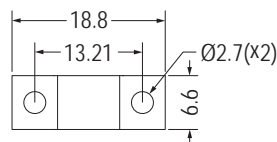

- Material: Zinc Plated Steel

Part No.	Package
EM-514H	1000

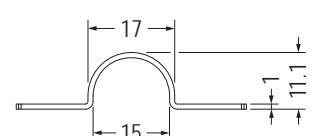
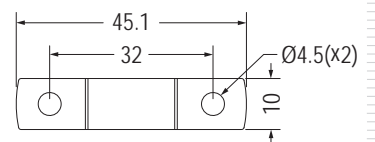

- Material: Aluminum

Part No.	Package
EM-646	1000

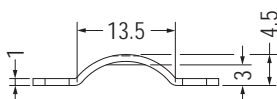
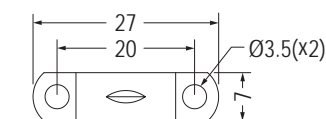

- Material: Steel

Part No.	Package
CLS-1	1000

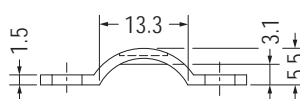
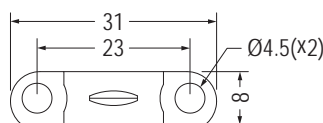

- Material: Steel

Part No.	Package
CLS-2	1000

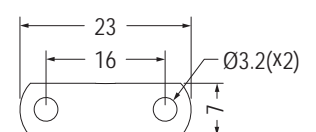

- Material: Zinc Plated Steel

Part No.	Package
CLT-16	1000

軌道式線扣組 CABLE CARRIER

用途：用於電線固定於軌道上。

- Material: Nylon 66 (UL)
- Flame Class: 94V-2/94V-0
- Color: Black
- Unit: mm
- Patented (專利品)
- USA Patented (美國專利品)

- 線材請勿超過橫切面的70%
- Please don't fill the cross-section more than 70%.

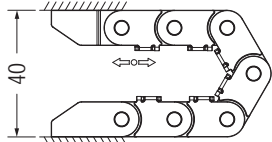
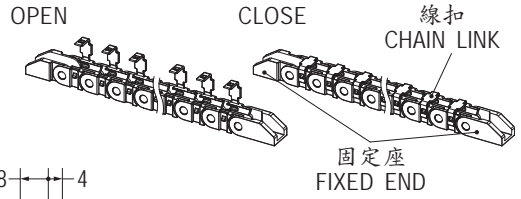
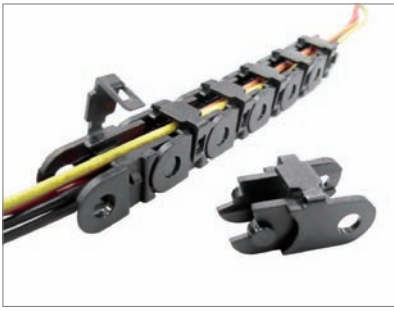

PRINCIPLE SKETCH - BEND RA-DIUS

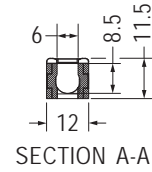
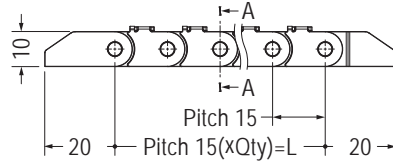
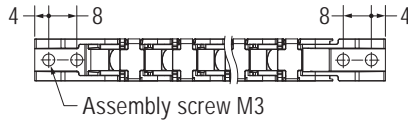

Part No.
GULY-1AB-XXF

4

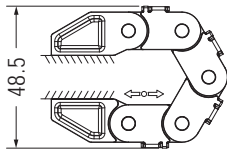
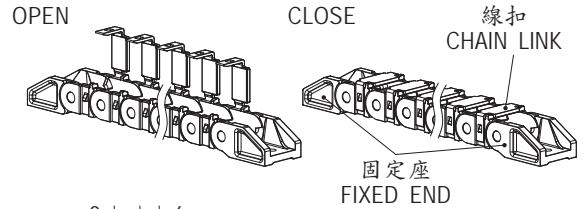

PRINCIPLE SKETCH - BEND RA-DIUS

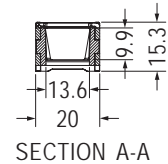
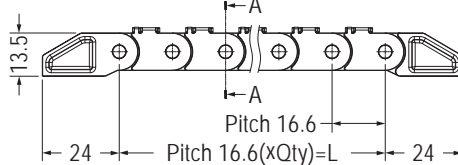
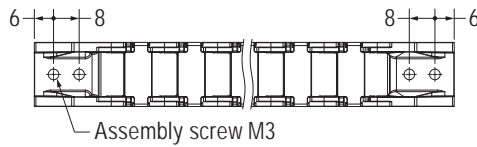

Part No.
GULY-2AB-XXF

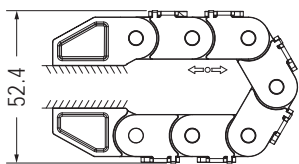
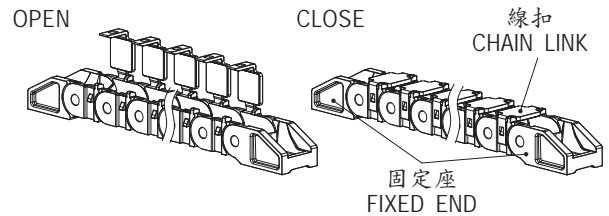

PRINCIPLE SKETCH - BEND RA-DIUS

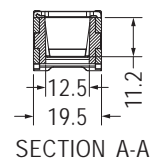
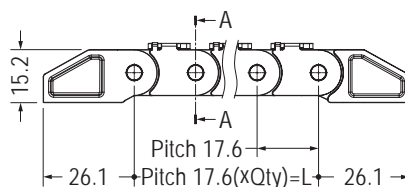
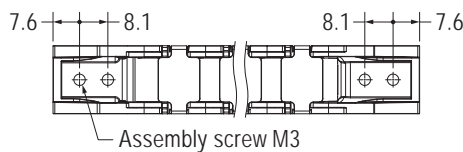

Part No.
GULY-3AB-XXF

軌道式線扣組 CABLE CARRIER

用途：用於電線固定於軌道上。

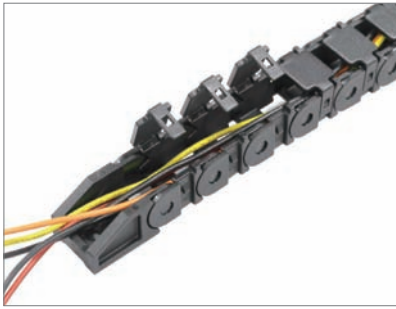

- Material: Nylon 66 (UL)
- Flame Class: 94V-2/94V-0
- Color: Black
- Unit: mm
- Patented (專利品)
- USA Patented (美國專利品)

- 線材請勿超過橫切面的70%
- Please don't fill the cross-section more than 70%.

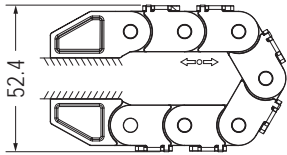
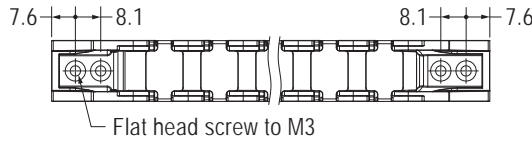
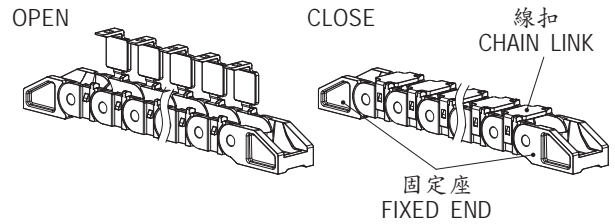

PRINCIPLE SKETCH - BEND RA-DIUS

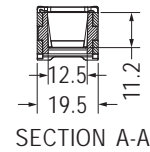
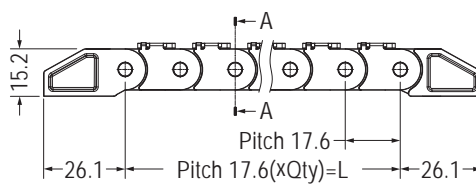

Part No.
GULY-3FG-XXF

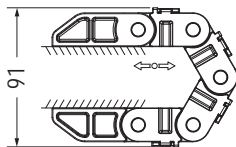
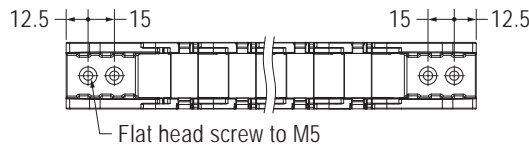
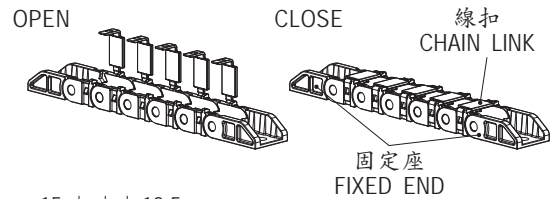
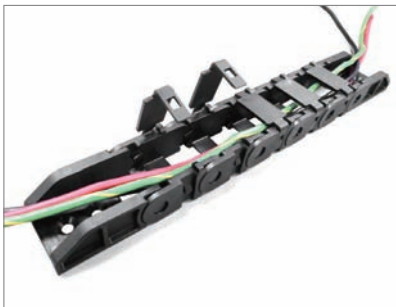

PRINCIPLE SKETCH - BEND RA-DIUS

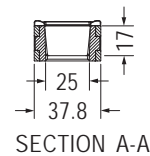
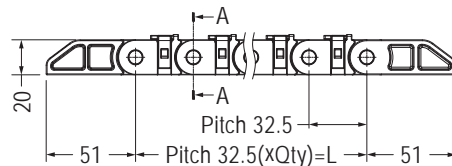

Part No.
GULY-5AB-XXF

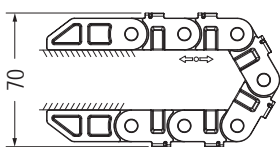
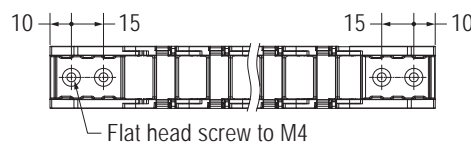
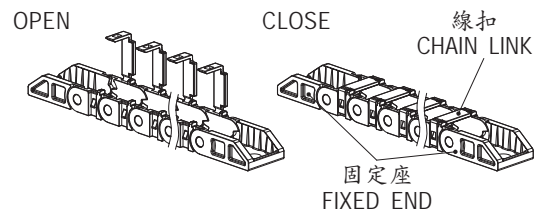

PRINCIPLE SKETCH - BEND RA-DIUS

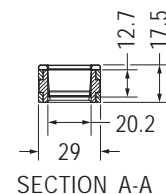
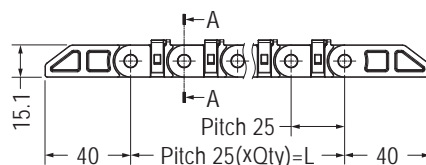

Part No.
GULY-6AB-XXF

軌道式線扣組 CABLE CARRIER

用途：用於電線固定於軌道上。

- Material: Nylon 66 (UL)
- Flame Class: 94V-2/94V-0
- Color: Black
- Unit: mm
- Patented (專利品)
- USA Patented (美國專利品)

- 線材請勿超過橫切面的70%
- Please don't fill the cross-section more than 70%.

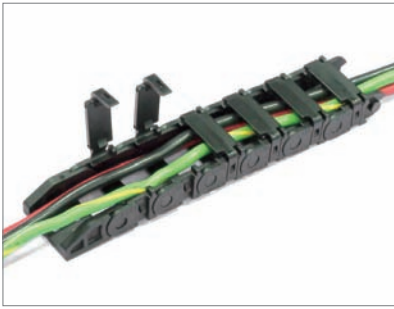

OPEN

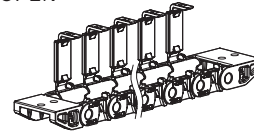

CLOSE

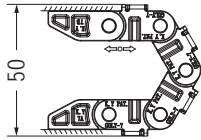
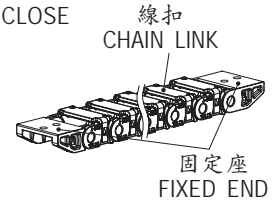

PRINCIPLE SKETCH - BEND RA-DIUS

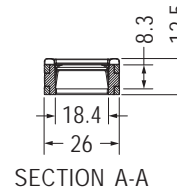
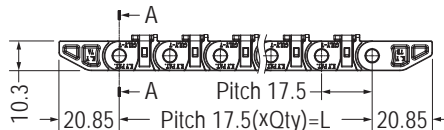
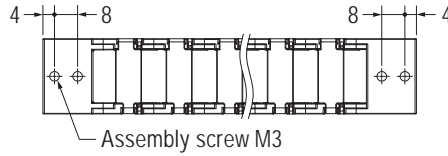

Part No.
GULY-7AB-XXF

4

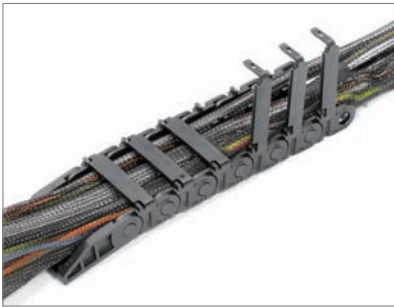

OPEN

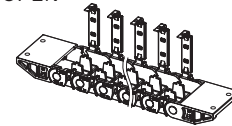

CLOSE

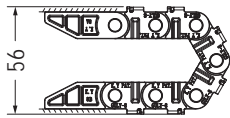
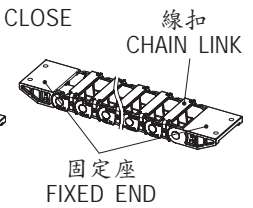

PRINCIPLE SKETCH - BEND RA-DIUS

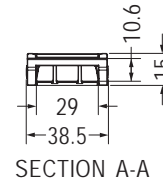
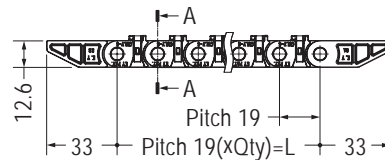
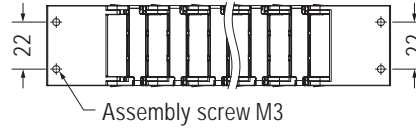

Part No.
GULY-8AB-XXF



OPEN

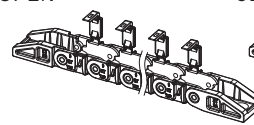

CLOSE

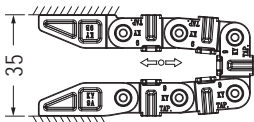
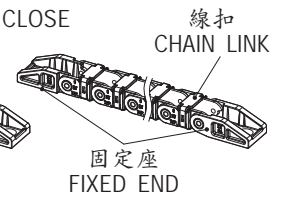

PRINCIPLE SKETCH - BEND RA-DIUS

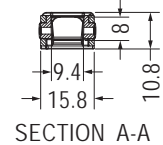
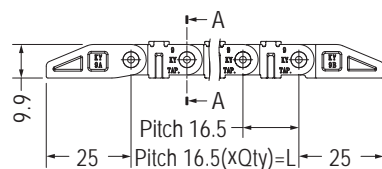
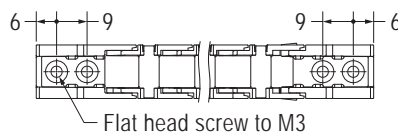

Part No.
GULY-9AB-XXF

軌道式線扣組 CABLE CARRIER

用途：用於電線固定於軌道上。

- Material: Nylon 66 (UL)
- Flame Class: 94V-2/94V-0
- Color: Black
- Unit: mm
- Patented (專利品)
- USA Patented (美國專利品)

- 線材請勿超過橫切面的70%
- Please don't fill the cross-section more than 70%.

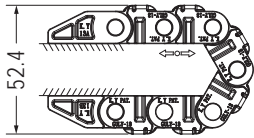
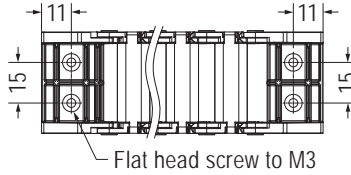
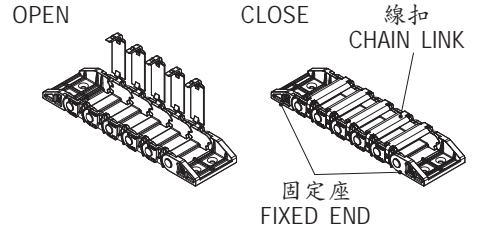
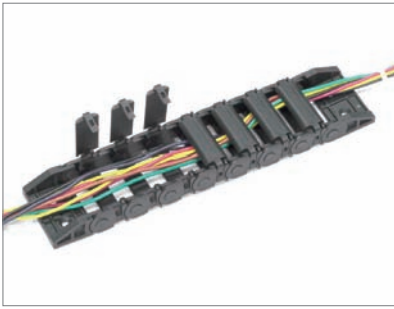

PRINCIPLE SKETCH - BEND RA-DIUS

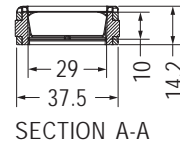
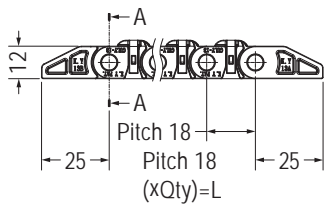

Part No.
GULY-13AB-XXF

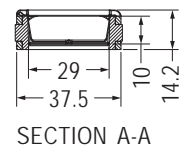
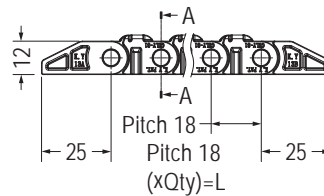
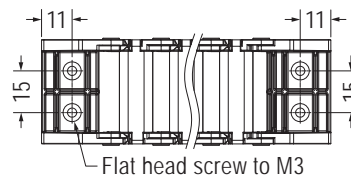
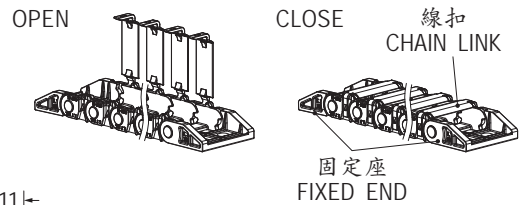

Part No.
GULY-31AB-XXF

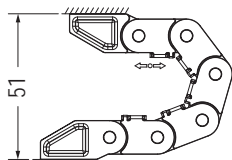
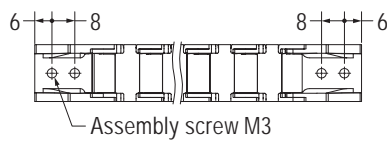
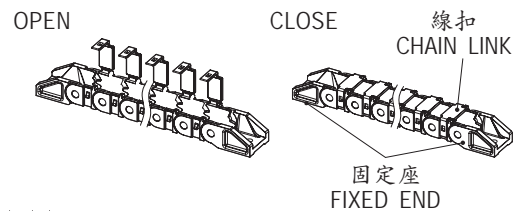

PRINCIPLE SKETCH - BEND RA-DIUS

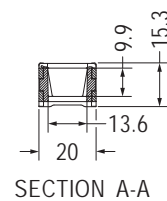
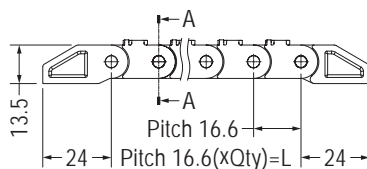

Part No.
GULY-15AB-XXF

軌道式線扣組 CABLE CARRIER

用途：用於電線固定於軌道上。

- Material: Nylon 66 (UL)
- Flame Class: 94V-2/94V-0
- Color: Black
- Unit: mm
- Patented (專利品)
- USA Patented (美國專利品)

- 線材請勿超過橫切面的70%
- Please don't fill the cross-section more than 70%.

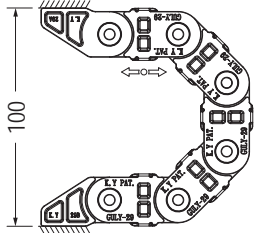
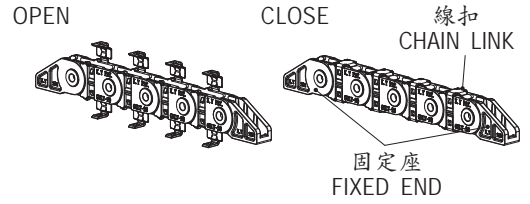
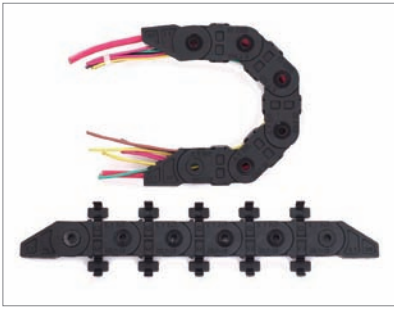

PRINCIPLE SKETCH - BEND RA-DIUS

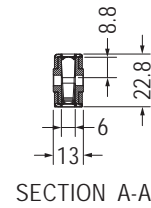
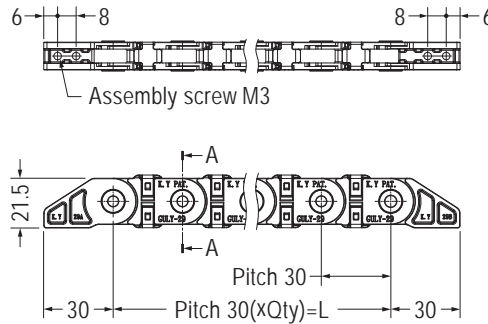

Part No.
GULY-29AB-XXF

4

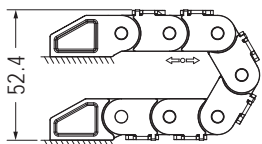
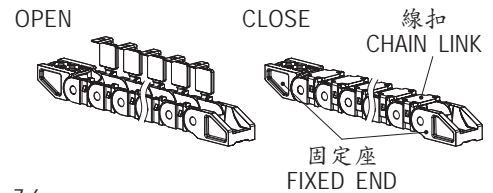

PRINCIPLE SKETCH - BEND RA-DIUS

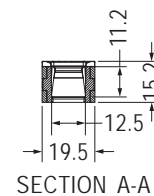
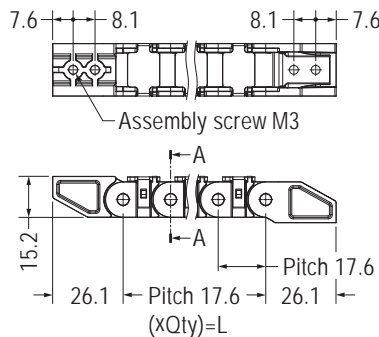

Part No.
GULY-3HI-XXCF

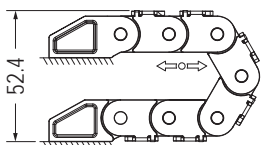
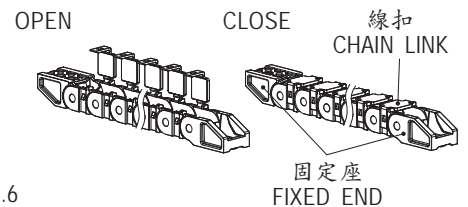
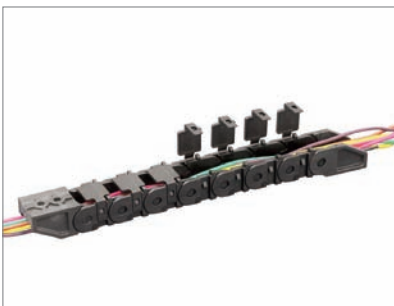

PRINCIPLE SKETCH - BEND RA-DIUS

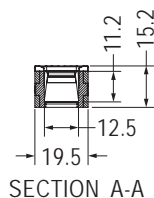
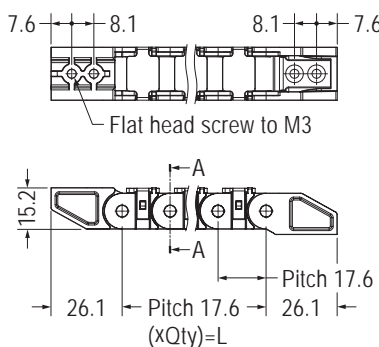

Part No.
GULY-3JK-XXCF

旋轉軌道式線扣組 ROTARY CABLE CARRIER



- Material: Nylon 66 (UL)
- Flame Class: 94V-2/94V-0
- Color: Black
- Unit: mm
- Patented (專利品)
- USA Patented (美國專利品)

用途：用於電線固定於軌道上，可轉方向，方便使用。

- 線材請勿超過橫切面的70%
- Please don't fill the cross-section more than 70%.

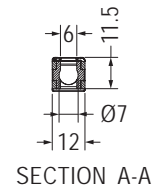
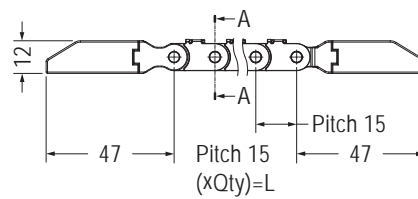
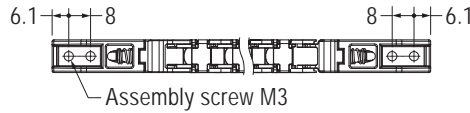
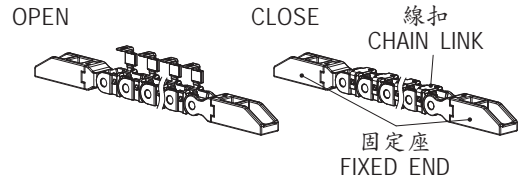

使用說明
Installation Guide

Part No.
GULY-1CDE-XXF

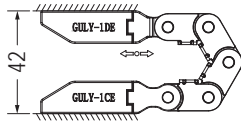

PRINCIPLE SKETCH - BEND RA-DIUS

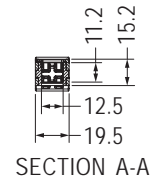
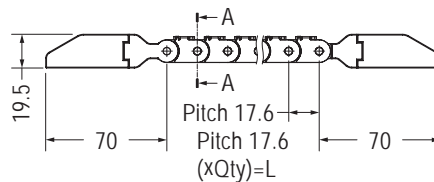
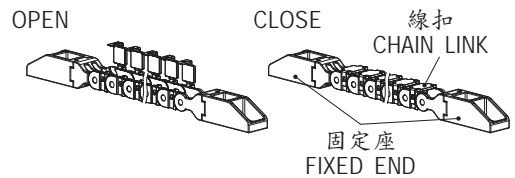

Part No.
GULY-3CDE-XXF

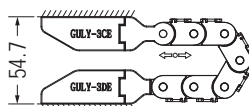

PRINCIPLE SKETCH - BEND RA-DIUS

軌道式線扣組 CABLE CARRIER

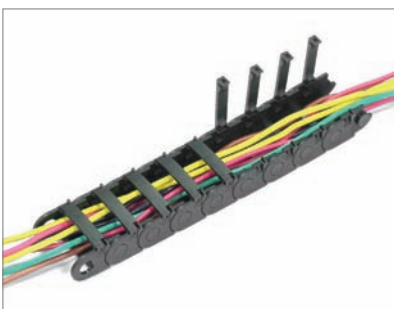

- Material: Nylon 66 (UL)
- Flame Class: 94V-2/94V-0
- Color: Black
- Unit: mm
- Patented (專利品)
- USA Patented (美國專利品)

用途：用於電線固定於軌道上。

- 線材請勿超過橫切面的70%
- Please don't fill the cross-section more than 70%.

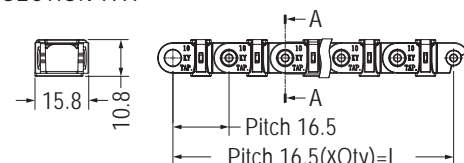
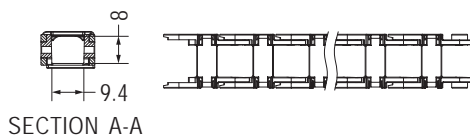
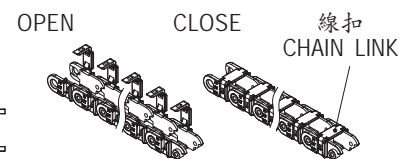

Part No.
GULY-10-XXF

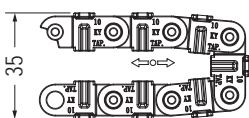

PRINCIPLE SKETCH - BEND RA-DIUS

軌道式線扣組 CABLE CARRIER

用途：用於電線固定於軌道上。

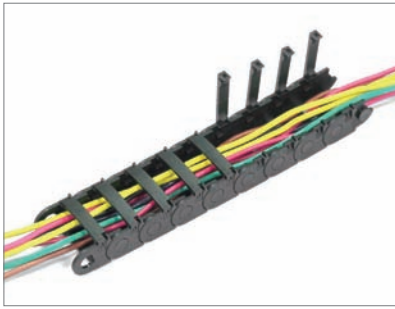

- Material: Nylon 66 (UL)
- Flame Class: 94V-2/94V-0
- Color: Black
- Unit: mm
- Patented (專利品)
- USA Patented (美國專利品)

- 線材請勿超過橫切面的70%
- Please don't fill the cross-section more than 70%.

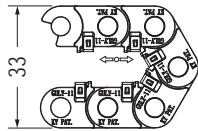

PRINCIPLE SKETCH - BEND RA-DIUS

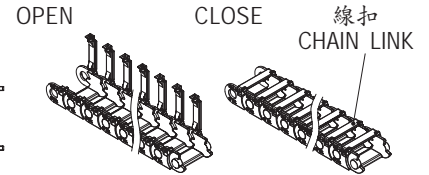
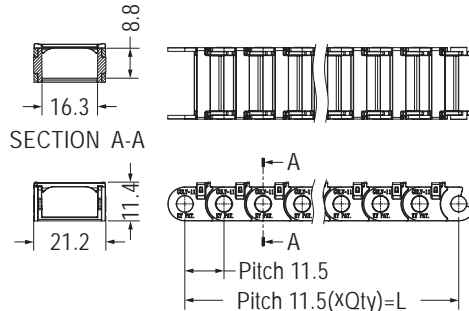

Part No.
GULY-11-XXF

4

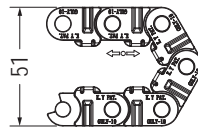

PRINCIPLE SKETCH - BEND RA-DIUS

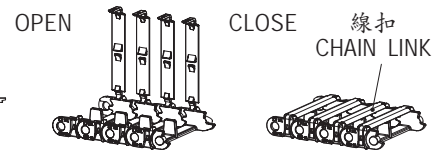
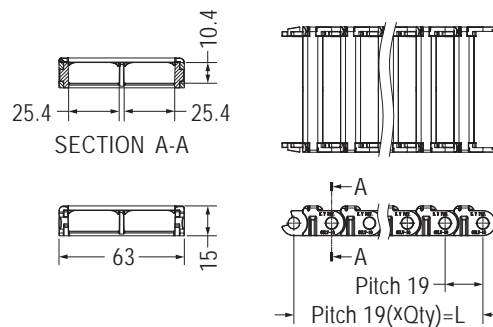

Part No.
GULY-19-XXF

電線束線環 HOSE CLAMP

用途：用於配線中，電線整理美觀不脫落。



- Material: POM (UL)/POM/Nylon 66 (UL)
- Flame Class: 94HB/94V-2/94V-0
- Color: Natural/Black
- Unit: mm

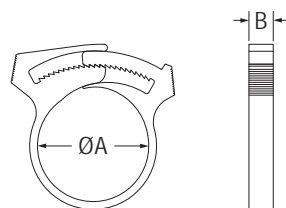

Part No.	A(MIN.-MAX.)	B	Package
SMAP-5	8.0~9.0	6.0	500
SMAP-6	10.0~11.0	5.5	
SMAP-7	10.0~12.5	5.9	
SMAP-7S	8.0~10.0	6.5	
SMAP-10	14.0~16.0	5.9	
SMAP-11	11.0~12.0	5.5	250
SMAP-16	17.5~21.0	5.9	
SMAP-18	20.0~22.0	6.0	
SMAP-19	21.0~24.0	5.9	
SMAP-22	23.3~26.65	5.9	
SMAP-24	25.0~27.0	7.4	
SMAP-24S	22.2~25.4	5.6	
SMAP-28	27.0~32.0	7.3	
SMAP-32	29.0~34.0	7.3	
SMAP-34	33.0~37.0	7.4	

防高壓線環 F.B.T CABLE CLIP

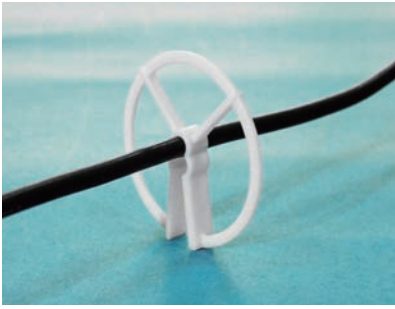

- Material: Nylon 66 (UL)
- Flame Class: 94V-2/94V-0
- Color: Natural
- Unit: mm

用途：保護C.R.T高壓與管壁間之絕緣，使用方便。

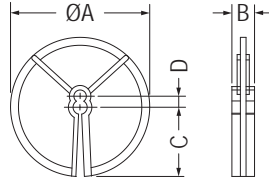

FIT CABLE: F

Part No.	A	B	C	D	F	Package
FBT-1	49.5	7.8	22.0	5.0	4.5~5.3	100
FBT-2	49.2	7.8	22.0	5.0	3.5~4.5	
FBT-3	50.2	7.4	23.0	5.0	2.5~3.5	
FBT-4	49.5	8.0	22.5	4.6	4.0~4.5 or 5.0~5.5	
FBT-5	49.2	8.0	22.0	4.7	3.7~4.2 or 4.5~5.2	

光纖固定座 FIBER OPTICS CABLE HOUSING

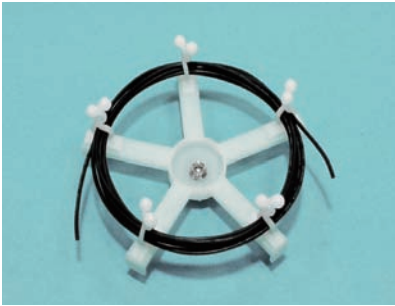

- Material: Nylon 66 (UL)
- Flame Class: 94V-2
- Color: Natural
- Unit: mm

用途：配合THA-、CH-系列產品使用，可固定光纖，不折斷，不衰減。

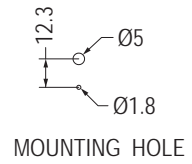
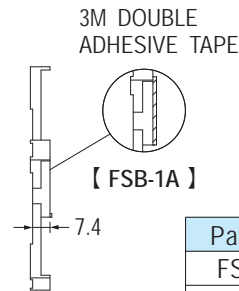
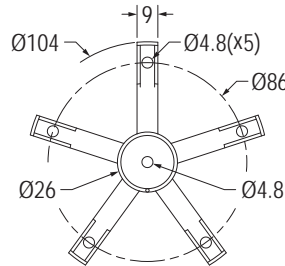

Part No.	Fitting	Package
FSB-1	Screw	50
FSB-1A	Adhesive	



- Material: Nylon 66 (UL)
- Flame Class: 94V-2
- Color: Natural
- Unit: mm

用途：配合WPEM系列產品使用，可固定光纖，不折斷，不衰減。

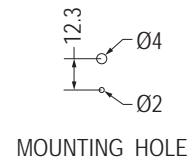
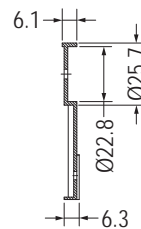
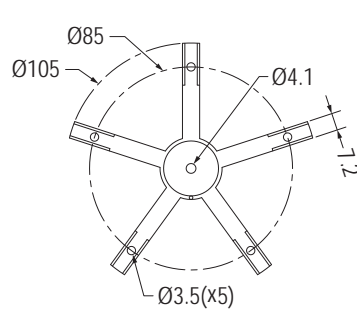

Part No.	Package
FSB-2	50

光纖固定座 FIBER OPTICS CABLE HOUSING

用途：保護和固定光纖，不折斷，不衰減。

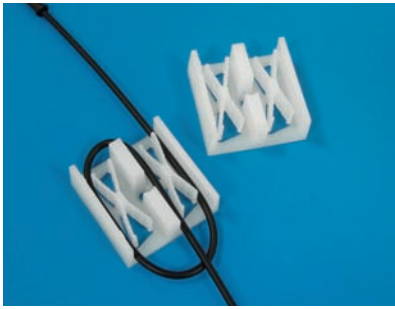

- Material: Nylon 66 (UL)
- Flame Class: 94V-2/94V-0
- Color: Black
- Unit: mm

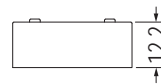
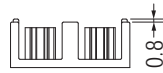
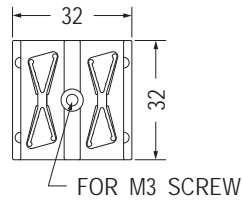

Part No.	Package
OFS-1	200

固定座 MOUNT

用途：汽車鈹金件之固定。



- Material: POM
- Color: Black
- Unit: mm

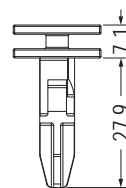
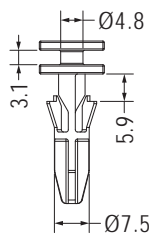
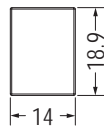

- 料號尾碼加-C，做為車規識別

Part No.	Package
CCMN-1-C	500



- Material: POM
- Color: Blue
- Unit: mm

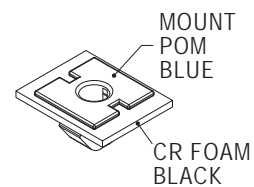
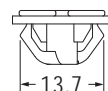
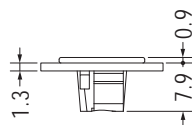
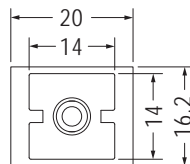

- 料號尾碼加-C，做為車規識別
- 可使用螺絲固定

Part No.	組零件(ASSY)	Package
CCMO-1-CF	CCMO-1-C	1000
	CR-13	