

REVISIONS			
REV	DESCRIPTION	DATE	BY

Patented Product  
專利產品

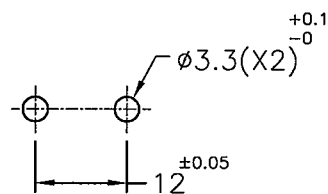

RECOMMEND MOUNTING HOLE

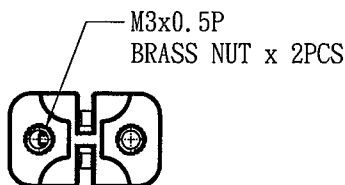
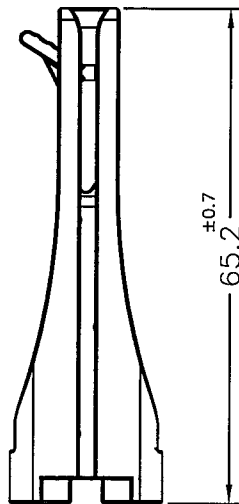
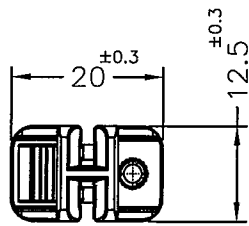
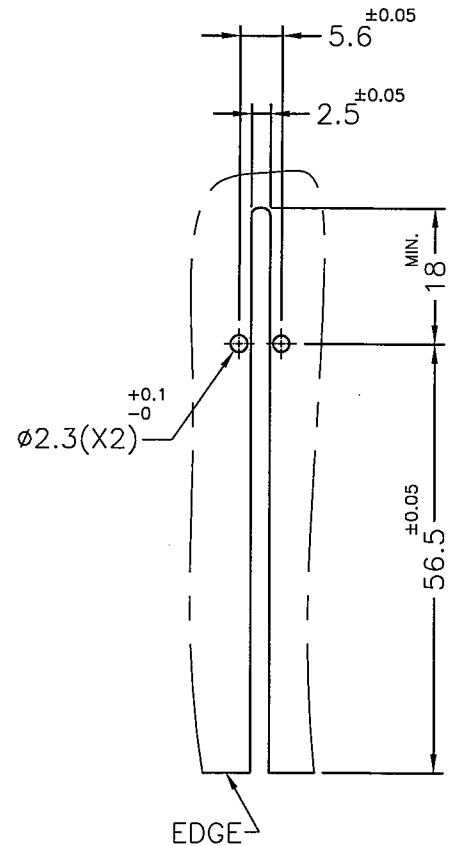



RECOMMEND MOUNTING HOLE  
RECOMMEND THICKNESS:1.6mm

NOTE:1. THE COLOR BATCH TEST REPORT IS ONLY FOR FIRST LOT TEST.

色母環保檢測報告, 僅提供原始測試報告.

2. MADE OF EQUIVALENT MATERIAL.

均可使用同等材質.

 <p>康揚企業股份有限公司 KANG YANG HARDWARE ENTERPRISE CO., LTD. 康揚塑膠(東莞)有限公司 KANG YANG PLASTIC(DONG GUAN) CO., LTD. 康哲電腦配件(吳江)有限公司 KANG CHEE COMPUTER COMPONENTS(WUJIANG) CO., LTD.</p>				TITLE	CARD GUIDE	SPEC. DWG.	
				MATERIAL	PC+ABS UL94V-0	DATE	2013.11.16
				FINISH		DRAWN	K.W
				COLOR	BLACK	CHECK	李柏宥
PART NUMBER	CGHB-65V0(B)	DRAWING NUMBER	CGHB-65	UNLESS OTHERWISE SPECIFIED TOLERANCE	SEE ABOVE	APPROVED	
SIZE	A4	SCALE	1:1	UNIT	mm	REV	A