

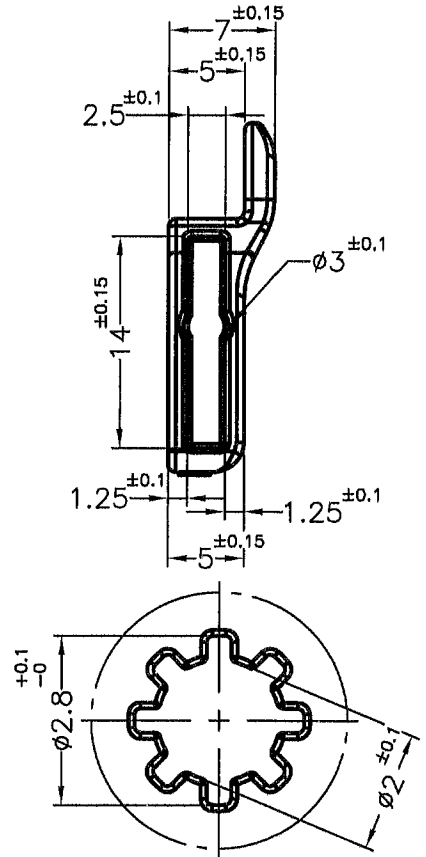

REVISIONS			
REV	DESCRIPTION	DATE	BY

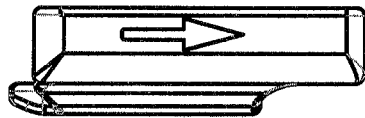
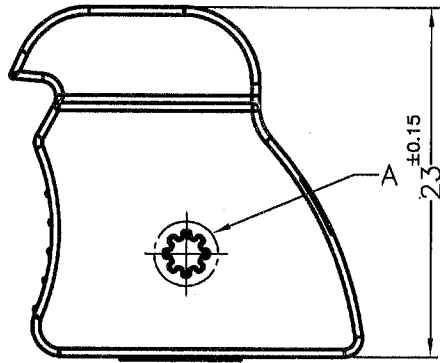
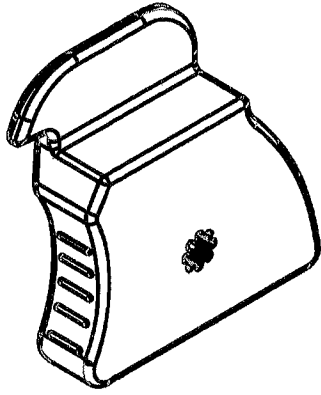

DETAIL A
SCALE 4:1

PART NO.	COLOR
CP-77(G)	GRAY
CP-77(O)	ORANGE(PMS-1525C)

NOTE: All measurement does not include gate which raises under 0.3mm.

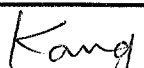
 康揚企業股份有限公司 KANG YANG HARDWARE ENTERPRISE CO., LTD. 康揚塑膠(東莞)有限公司 KANG YANG PLASTIC(DONG GUAN) CO., LTD. 康哲電腦配件(吳江)有限公司 KANG CHE COMPUTER COMPONENTS(WUJIANG) CO., LTD.				TITLE	CARD PULLER	SPEC. DWG.	
				MATERIAL	PC+ABS UL94V-0	DATE	2010.11.18
				FINISH		DRAWN	ROBERT
				COLOR	SEE ABOVE	CHECK	
PART NUMBER	SEE ABOVE	DRAWING NUMBER	CP-77	UNLESS OTHERWISE SPECIFIED TOLERANCE	SEE ABOVE	APPROVED	
SIZE	A4	SCALE	2:1	UNIT	mm	REV	A